

› Millenium 3 PLC Smart Compact CD12/CB12 With/without display

- › Highly visible blue LCD display with 4 lines of 18 characters, with controllable backlighting
- › Compatible with the whole of the specific function blocks library of the software workshop
- › Extended temperature range (-20 °C → +70 °C)
- › Analogue inputs 0-10 V_{DC}, potentiometer, NTC, (0-20mA/Pt100 with adapters)
- › Selectable parameter setting: option to choose the parameters settable from the front panel



CD12 with display



CB12 without display

Selection guide				
Power supply	Inputs	Outputs	CD12	CB12
12 V _{DC}	8 digital of which 4 analogue	4 relays 8A	88974045	-
12 V _{DC}	8 digital of which 4 analogue	4 solid state 0.5A of which 1 is PWM	88974046	88974026
24 V _{DC}	8 digital of which 4 analogue	4 relays 8A	88974041	88974021
24 V _{DC}	8 digital of which 4 analogue	4 solid state 0.5A of which 1 is PWM	88974042	-
24 V _{AC}	8 digital	4 relays 8A	88974044	88974024
100 → 240 V _{AC}	8 digital	4 relays 8A	88974043	88974023

Accessories		
Type	Description	Code
M3 Soft	Multilingual programming software with the specific functions library	88970111
PA	EEPROM memory cartridge	88970108
PA	3m serial cable: PC → Millenium 3	88970102
PA	3m USB cable: PC → Millenium 3	88970109
PA	Millenium 3 → Bluetooth® interface (class A 10m)	88970104

12 V_{DC}	24 V_{DC}	24 V_{AC}	100 → 240 V_{AC}
--------------------------	--------------------------	--------------------------	---------------------------------

General characteristics	
Product certifications (according to IEC/EN 60529)	UL, CSA, GL (*) (*) GL: except for 88 970 xxx
Conforms to the Low Voltage directive (according to 73/23/EEC)	EN (IEC) 61131-2 (Open equipment)
Conforms to the EMC directive (according to 89/336/EEC)	EN (IEC) 61131-2 (Zone B) EN (IEC) 61000-6-2, EN (IEC) 61000-6-3 (*), EN (IEC) 61000-6-4 (* Except for configurations (88 970 1x1 or 88 970 1x2) + (88 970 250 or 88 970 270) + 88 970 241 class A (class B: work in progress)
Grounding	None
Degree of protection (according to IEC/EN 60529)	IP 40 for front panel IP 20 for terminal block
Over-voltage category (according to IEC/EN 60664-1)	3

	12 V _{DC}	24 V _{DC}	24 V _{AC}	100 → 240 V _{AC}
Degree of interference (according to IEC/EN 61131-2)	2			
Maximum allowable altitude	For operation: 2000m For transport: 3048m			
Mechanical strength	Vibration resistance IEC/EN 60068-2-6, test Fc Shock resistance IEC/EN 60068-2-27, test Ea			
Electrostatic discharge withstand	Electrostatic discharge immunity IEC/EN 61000-4-2, level3			
HF interference withstand (immunity)	Radiated electromagnetic field immunity IEC/EN 61000-4-3, level 3 Fast transient/burst immunity IEC/EN 61000-4-4, level 3 Surge immunity IEC/EN 61000-4-5 Common mode radio frequency IEC/EN 61000-4-6, level 3 Voltage dips and interruptions (~) IEC/EN 61000-4-11 Damped oscillatory wave immunity IEC/EN 61000-4-18			
Conducted and radiated interference (according to EN 55022/11 group 1)	Class B(*) (*) Except for configurations (88 970 1x1 or 88 970 1x2) + (88 970 250 or 88 970 270) + 88 970 241 class A (class B: work in progress)			
Operating temperature	-20 → +70 °C (+40 °C in unventilated cabinet) according to IEC/EN 60068-2-1 and IEC 60068-2-2 Duty cycle 100% (6A relay) Duty cycle 66% (8A relay)			
Storage temperature	-40 → +80 °C			
Relative humidity	95 % max. (non-condensing)			
Connection capacity to screw terminal (Tightened by screwdriver of 3.5mm diameter)	Flexible wire with single conductor terminal end:	0.25 to 2.5 mm ² 2 conductors 0.25 to 0.75 mm ²		
	Semi-rigid single conductor wire:	0.2 to 2.5 mm ²		
	Rigid single conductor wire:	0.2 to 2.5 mm ² 2 conductors 0.2 to 1.5 mm ²		
	Tightening torque	0.5 Nm		

Processing characteristics

LCD display	CD: display with 4 lines of 18 characters
Programming method	Ladder or function blocks / SFC (Grafcet)
Ladder program size	Ladder: 120 lines Function blocks: 350 typical blocks
Program memory	Flash EEPROM
Removable memory	EEPROM
Data memory	368 bits / 200 words
Backup time (in the event of a power failure)	Program and settings in PLC 10 years Program and settings on removable memory 10 years Data memory 10 years
Cycle time	Ladder: 20 ms typically Function blocks: 6 to 90 ms
Response time	Input data acquisition time + 1 to 2 cycles
Clock running time	10 years (lithium battery) at 25 °C
Clock drift	Drift < 12 min/year (at 25 °C) 6 s/month (at 25 °C and calibrated)
Accuracy of delay blocks	1% +- 2 cycles

Power supply

	12 V _{DC}	24 V _{DC}	24 V _{AC}	100 - 240 V _{AC}
Nominal voltage	12 V _{DC}	24 V _{DC}	24 V _{AC}	100 - 240 V _{AC}
Operating limits	(-13 % / +20 %) 10.4 → 14.4 V _{DC}	(-20 % / +25 %) 19.2 → 30 V _{DC}	(-15 % / +20 %) 20.4 V _{AC} → 28.8 V _{AC}	(-15 % / +10 %) 85 - 264 V _{AC}
Operating frequency	N/A		50/60 Hz (+4 %/-6 %) 47 to 53 Hz / 57 to 63 Hz	
Startup time from power on	< 1.2s			
Micro-break immunity	≤ 1 ms (repeated 20 times)		10 ms (repeated 20 times)	

	12 V _{DC}	24 V _{DC}	24 V _{AC}	100 → 240 V _{AC}
Maximum power draw	CD12 - CB12: 1.5 W CD12 - CB12 with solid state output: 1.5 W	CD12 - CB12: 4 W CD12 - CB12 with solid state output - 3 W	CD12 - CB12: 4 VA	CD12 - CB12: 7 VA
Inverted polarity protection	Yes		N/A	
Effective insulation voltage	N/A		1780 V (50-60 Hz)	

Digital inputs

Position of the inputs	4 inputs from I1 to I4		8 inputs from I1 to IE	
Input voltage	12 V _{DC} (-13 % / +20 %)	24 V _{DC} (-20 % / +25 %)	24 V _{AC} (-15% / +20 %)	100 → 240 V _{AC} (-15 % / +10 %)
Input current	3.9 mA @ 10.44 V _{DC} 4.4 mA @ 12.0 V _{DC} 5.3 mA @ 14.4 V _{DC}	2.6 mA @ 19.2 V _{DC} 3.2 mA @ 24.0 V _{DC} 4.0 mA @ 30.0 V _{DC}	4.4 mA @ 20.4 V _{AC} 5.2 mA @ 24.0 V _{AC} 6.3 mA @ 28.8 V _{AC}	0.24 mA @ 85 V _{AC} 0.75 mA @ 264 V _{AC}
Input impedance	6.45 kΩ	7.4 kΩ	4.6 kΩ	350 kΩ
Logic state 1 triggering voltage	≥ 7 V _{DC}	≥ 15 V _{DC}	≥ 14 V _{AC}	≥ 79 V _{AC}
Logic state 1 triggering current	≥ 2 mA	≥ 2.2 mA	> 2 mA	> 0.17 mA
Logic state 0 triggering voltage	≤ 3 V _{DC}	≤ 5 V _{DC}	≤ 5 V _{AC}	≤ 40 V _{AC}
Logic state 0 triggering current	< 0.9 mA	< 0.75 mA	< 0.5 mA	
Response time	1 → 2 cycles + 6 ms		50 ms	
Sensor type	Contact or 3 wire PNP			
Galvanic isolation	No			
Status indication	On the LCD screen for CD and XD			

Analogue or digital inputs

Inputs used in analogue mode

Position of the inputs	4 inputs from IB to IE		-
Measurement range	(0 → 10 V) or (0 → V _{supply})	0 → 10 V or 0 → V _{supply}	N/A
Input impedance	14 kΩ	12 kΩ	N/A
Maximum input voltage	14.4 V _{DC}	30 V _{DC}	N/A
LSB value	14 mV	29 mV	N/A
Input type	Common mode		N/A
Resolution	10 bits		N/A
Conversion time	PLC cycle time		N/A
Precision at 25 °C	± 5 %		N/A
Precision at 55 °C	± 6.2 %		N/A
Repeatability at 55 °C	± 2 %		N/A
Analogue channel to power supply isolation	None		N/A
Cabling distance	10 m maximum, with shielded cable (sensor not isolated)		N/A
Inverted polarity protection	Yes		N/A
Potentiometer control	2.2 kΩ / 0.5 W (Preset) 10 kΩ max.		N/A

Inputs in digital mode

Position of the inputs	4 inputs from IB to IE		-
Input voltage	12 V _{DC} (-13 % / +20 %)	24 V _{DC} (-20 % / +25 %)	N/A
Input current	0.7 mA @ 10.44 V _{DC} 0.9 mA @ 12.0 V _{DC} 1.0 mA @ 14.4 V _{DC}	1.6 mA @ 19.2 V _{DC} 2.0 mA @ 24.0 V _{DC} 2.5 mA @ 30.0 V _{DC}	N/A
Input impedance	14 kΩ	7.4 kΩ	N/A
Logic state 1 triggering voltage	≥ 7 V _{DC}	≥ 15 V _{DC}	N/A
Logic state 0 triggering voltage	≤ 3 V _{DC}	≤ 5 V _{DC}	N/A

	12 V _{DC}	24 V _{DC}	24 V _{AC}	100 → 240 V _{AC}
Response time	1 → 2 cycles + 6 ms		N/A	
Sensor type	Contact or 3 wire PNP		N/A	
Galvanic isolation	No		N/A	
Status indication	On the LCD screen for CD and XD		N/A	

Relay outputs

Maximum breaking voltage	5 to 150 V _{DC} 24 to 250 V _{AC}
Cut-off current / thermal	CB-CD: 8 A
Electrical lifetime of 500.000 operations	Usage category DC-12: 24 V, 1.5 A Usage category DC-13: 24 V (L/R = 10 ms), 0.6 A Usage category AC-12: 230 V, 1.5 A Usage category AC-15: 230 V, 0.9 A
Minimum switching current (with minimum voltage of 12 V)	10 mA
Contact reliability at low levels	12 V, 10 mA
Maximum operating frequency	Unloaded: 10 Hz At rated current: 0.1 Hz
Mechanical lifetime	10 000 000 operating cycles
Rated impulse withstand voltage (according to IEC/EN 60947-1 and et IEC/EN 60664-1)	4 kV
Response time	Make 10 ms Break 5 ms
Built-in protections	Against short-circuits: None Against over-voltages and over-currents: None
Status indication	On the LCD screen for CD and XD

Solid state digital/PWM outputs (Only on VDC model)

Solid state PWM outputs	O4	-
Cut-off voltage / operating limit	19.2-30 V _{DC}	-
Nominal voltage	24 V _{DC}	-
Nominal current	0.5 A	-
Maximum breaking current	0.625 A	-
State 1 output voltage drop	≤ 2 V at I = 0.5 A	-
Response time	Make ≤ 1 ms Break ≤ 1 ms	-
Frequency	1 Hz maximum for inductive load	-
Built-in protections	Against over-voltages and short-circuits: Yes Against over-voltages (*): Yes Against power supply reversal: Yes	-
Minimum load	0.1 A	-
Maximum incandescent load	0.1 mA / 24 V _{DC}	-
Galvanic isolation	No	-
PWM frequency	14.11 Hz 56.45 Hz 112.90 Hz 225.80 Hz 451.59 Hz 1.806.37 Hz	-
PWM duty cycle	0 → 100 % (256 steps for CD,XD and 1024 steps for XA)	-

	12 V _{DC}	24 V _{DC}	24 V _{AC}	100 → 240 V _{AC}
PWM accuracy at 120 Hz	< 5% (from 20 % → 80 %) load at 10 mA		-	-
PWM accuracy at 500 Hz	< 10% (from 20 % → 80 %) load at 10 mA		-	-
PWM maximum breaking current	50mA	50 mA	-	-
Maximum cable length for PWM	20 m		-	-
Status indication	On the LCD screen for CD and XD		-	-

Schematics
Footprint
Version

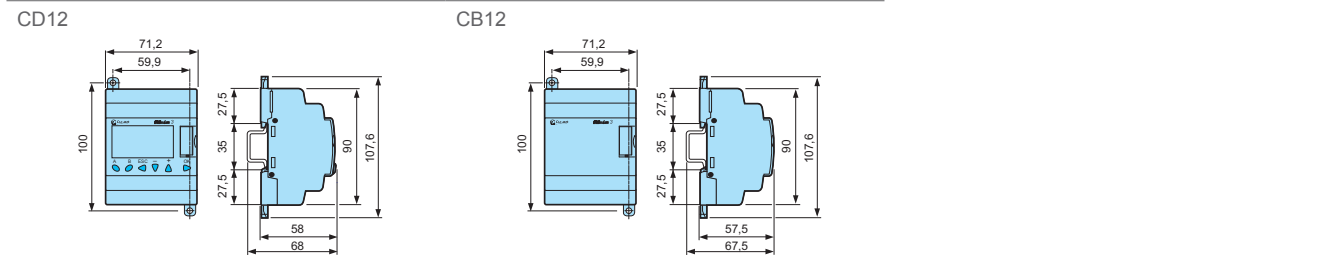

Input/output wiring
Inputs 12 V_{DC}, 24 V_{DC}

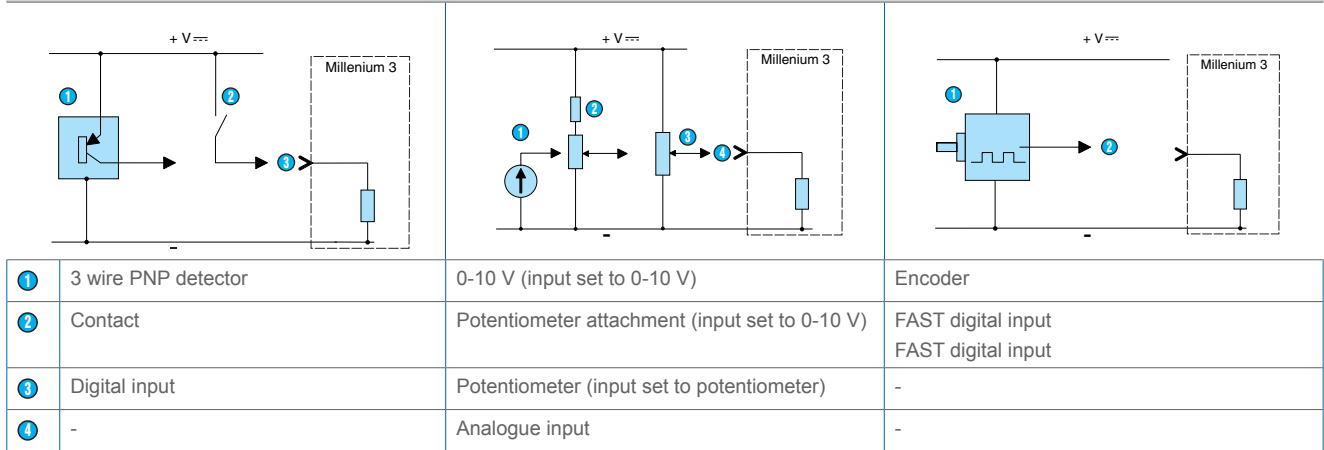

Inputs 100-240 V_{AC}, 24 V_{AC}

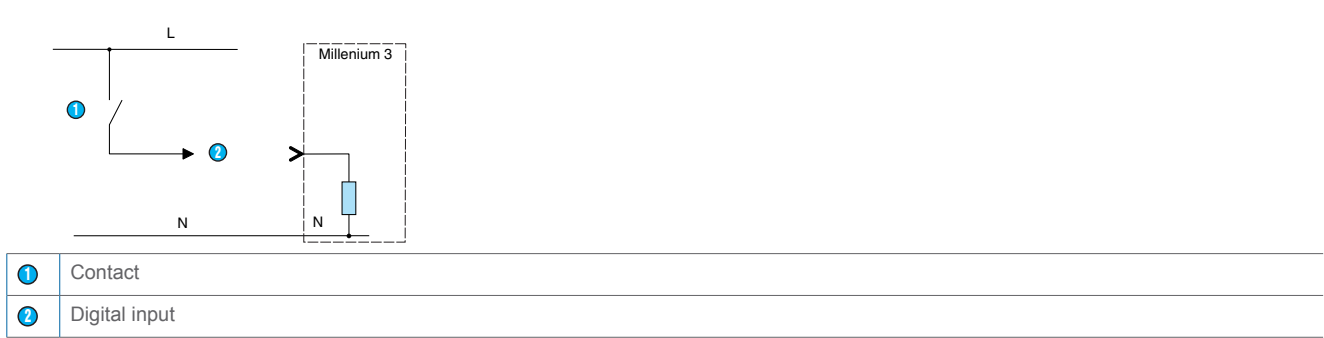

Relay outputs

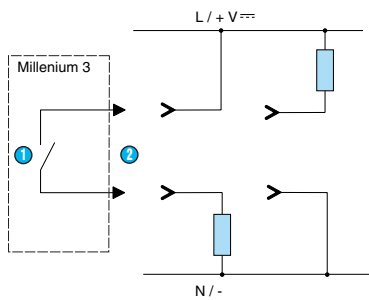

1	Contact
2	Digital input

Solid state outputs

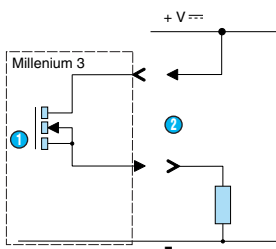

1	MOS transistor
2	Digital/PWM output

Implementation of Inputs/outputs

Inputs

V~

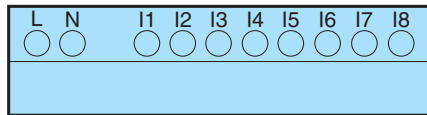

V=

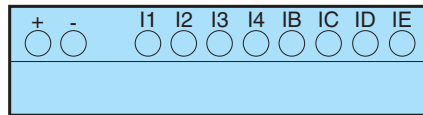

Relay outputs

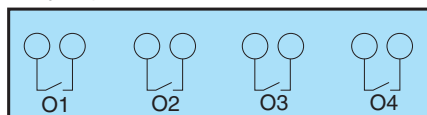

Solid state outputs

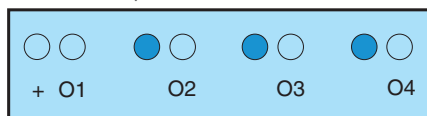

Warning:

The product information contained in this catalogue is given purely as information and does not constitute a representation, warranty or any form of contractual commitment. Crouzet Automatismes SAS and its subsidiaries reserve the right to modify their products without notice. It is imperative that we should be consulted over any particular use or application of our products and it is the responsibility of the buyer to establish, particularly through all the appropriate tests, that the product is suitable for the use or application. Under no circumstances will our warranty apply, nor shall we be held responsible for any application (such as any modification, addition, deletion, use in conjunction with other electrical or electronic components, circuits or assemblies, or any other unsuitable material or substance) which has not been expressly agreed by us prior to the sale of our products.

X-ON Electronics

Largest Supplier of Electrical and Electronic Components

Click to view similar products for [Development Software](#) category:

Click to view products by [Crouzet](#) manufacturer:

Other Similar products are found below :

[RAPPID-567XFSW](#) [SRP004001-01](#) [SW163052](#) [SYSWINEV21](#) [Core429-SA](#) [WS01NCTF1E](#) [W128E13](#) [SW89CN0-ZCC](#) [IPS-EMBEDDED](#)
[IP-UART-16550](#) [MPROG-PRO535E](#) [AFLCF-08-LX-CE060-R21](#) [WS02-CFSC1-EV3-UP](#) [SYSMAC-STUDIO-EIPCPLR](#) [LIB-PL-PC-N-](#)
[1YR-DISKID](#) [LIB-PL-A-F](#) [SW006026-COV](#) [1120270005](#) [1120270006](#) [MIKROBASIC PRO FOR FT90X \(USB DONGLE\)](#) [MIKROC PRO](#)
[FOR FT90X \(USB DONGLE\)](#) [MIKROC PRO FOR PIC \(USB DONGLE LICENSE\)](#) [MIKROBASIC PRO FOR AVR \(USB DONGLE LICEN](#)
[MIKROBASIC PRO FOR FT90X](#) [MIKROC PRO FOR DSPIC30/33 \(USB DONGLE LI](#) [MIKROPASCAL PRO FOR ARM \(USB DONGLE](#)
[LICE](#) [MIKROPASCAL PRO FOR FT90X](#) [MIKROPASCAL PRO FOR FT90X \(USB DONGLE\)](#) [MIKROPASCAL PRO FOR PIC32 \(USB](#)
[DONGLE LI](#) [SW006021-2H](#) [ATATMELSTUDIO](#) [2400573](#) [2702579](#) [2733](#) [2988609](#) [2702546](#) [SW006022-DGL](#) [2400303](#) [2701356](#) [VDSP-](#)
[21XX-PCFLOAT](#) [VDSP-BLKFN-PC-FULL](#) [88970111](#) [DG-ACC-NET-CD](#) [55195101-102](#) [SW1A-W1C](#) [MDK-ARM](#) [PCI-EXP1-E3-US](#)
[PCI-T32-E3-US](#) [SW006021-2NH](#) [SW006021-1H](#)