

› Logic Controller Millenium Slim

- › A logic controller in a 17.5 mm (0.69") width
- › DIN rail mount and panel mount
- › 8 I/Os: 4 digital inputs (convertibles to analog in DC versions) and 4 digital outputs (relay or static)
- › Highspeed & PWM inputs available in DC versions, PWM outputs available in static versions
- › DC (24V) and AC (110-240V) power supply available
- › Removable connectors
- › Wireless Bluetooth to communicate with other MilleniumSlim logic controllers, retrieve datalog and program transfer
- › Virtual display possible in mobile devices trough Crouzet app
- › Intuitive & easy-to-use graphical programming software (FBD)
- › Certified CE, cULus Listed, NOM, RCM, SCM, UKCA



Millenium Slim

| Product Selection | | | | | | | | |
|-------------------|------------|--|---|----------------|--------------------|-------------------------------------|------------|-------------|
| Type | Total I/Os | Input | Output | Supply Voltage | Communication | Screen | Connectors | Part Number |
| CB8R (AC) | 8 | 4 Inputs › 4 x Digital | 4 Outputs › 4 x 6 A Relay | 110-240 V~ | Bluetooth Embedded | Via App: Crouzet Virtual Display | Included | 88983903 |
| CB8R (DC) | | 4 Inputs › 2 x Convertibles to | 4 Outputs › 4 x 6 A Relay | 24 VDC | | | | 88983901 |
| CB8S (DC) | | <ul style="list-style-type: none"> ▪ Digital ▪ Analog ▪ High-Speed › 2 x Convertibles to <ul style="list-style-type: none"> ▪ Digital ▪ Analog ▪ PWM | 4 Outputs › 4 x 0.5 A Static (Transistor - Sourcing) | | | | | 88983902 |

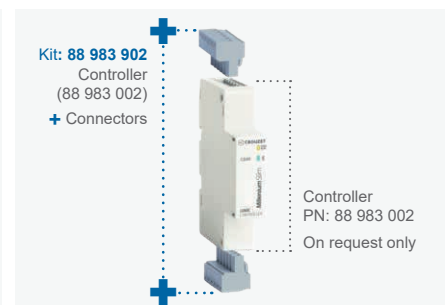
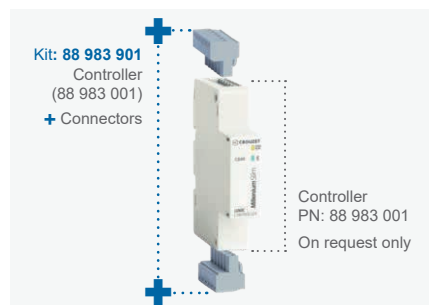
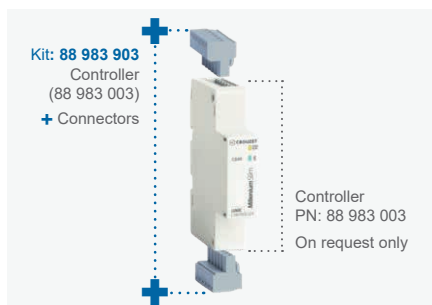

You have a project? Contact us on www.crouzet.com

Description:

Millenium Slim: The smallest logic controller ever!

Designed for **space reduction** in any control panel or machine thanks to its 17.5 mm (0.69") body, this multipurpose industrial logic controller with 8 highly configurable I/Os, can replace dozens of control panel products, and will give **wireless capabilities** to your applications via Bluetooth. Powered by the **easiest-to-use** and free programming software "CrouzetSoft", a virtual display from any smartphone or PC, remote program transferring and plenty of pre-programmed applications ready to quick-start your next small-scale automation project.

For more information about **Millenium Slim**, please visit www.crouzet.com.

| | Millenium Slim CB8R (AC) | Millenium Slim CB8R (DC) | Millenium Slim CB8S (DC) |
|---|--|-----------------------------|-----------------------------|
| General Characteristics | | | |
| Part Number | 88983903 | 88983901 | 88983902 |
| Safety certifications | CE, cULus Listed, NOM, RCM, SCM, UKCA | | |
| Environmental certifications | Reach, RoHS | | |
| Conformity with programmable controllers' standard | CEI/EN 61131-2 (Open equipment) | | |
| Conformity with the RADIO directive (in accordance with 2014/53/UE) | <ul style="list-style-type: none"> ▪ EN 61010-1 & EN 61010-2-201: Safety requirements ▪ EN 301489-1 & EN 301489-17: EMC requirements ▪ EN 61000-6-1, EN 61000-6-2, EN 61000-6-3 & EN 61000-6-4: EMC requirements ▪ EN 300328: Radio requirements ▪ EN62311: Health requirements | | |
| Power supply earthing | None | | |
| Overvoltage category | II (in accordance with IEC/EN 60664-1) | | |
| Pollution Degree | 2 (in accordance with IEC/EN 61131-2) | | |
| Maximum utilization altitude | <ul style="list-style-type: none"> ▪ Operation: 2000 m ▪ Transport: 3000 m | | |
| Mechanical resistance | <ul style="list-style-type: none"> ▪ Immunity to vibrations IEC/EN 60068-2-6, Fc test ▪ Immunity to shock IEC/EN 60068-2-27, Ea test ▪ Degrees of protection provided by enclosures of electrical equipment against external mechanical impacts CEI62262: IK07 (test method: 500G steel ball drop, 40cm high) | | |
| Resistance to electrostatic discharge | Immunity to ESD IEC/EN 61000-4-2, level 3 | | |
| Resistance to HF interference (Immunity) | <ul style="list-style-type: none"> ▪ Immunity to radiated electrostatic fields IEC/EN 61000-4-3, level 3 ▪ Immunity to fast transients (burst immunity) IEC/EN 61000-4-4, level 3 ▪ Immunity to shock waves IEC/EN 61000-4-5 ▪ Radio frequency in common mode IEC/EN 61000-4-6, level 3 | | |
| Conducted and radiated emissions (in accordance with EN 55032) | Class B | | |
| Bluetooth protocol | Bluetooth ≥ V5.0 | | |
| Bluetooth range | ≤ 10 m (max. 20 m in free fields) | | |
| Operating temperature | Ventilated enclosure: -20 °C (-4 °F) to +60 °C (140 °F) Non-ventilated enclosure: -20 °C (-4 °F) to +40 °C (104 °F) UL: maximum surrounding air: +50 °C (122 °F) | | |
| Storage temperature | -40 °C (-40 °F) to +80 °C (176 °F) | | |
| Humidity | 95% max. (no condensation or dripping water) | | |
| Connecting capacity | <ul style="list-style-type: none"> ▪ Flexible wire with ferrule: 1 conductor: 0.25 to 2.5 mm² ▪ Flexible wire with ferrule: 2 conductors: 0.25 to 1 mm² (1.5 mm² with ferrule TWIN) ▪ Rigid wire: 1 conductor: 0.2 to 2.5 mm² ▪ Rigid wire: 2 conductors: 0.2 to 1 mm² ▪ Tightening torque: 0.5 N.m (4.5 lb-in) (screw M3, tighten using a flat screwdriver) ▪ Stripping length: 7 mm | | |
| Housing material | Makrolon, UL94V0 | | |
| Housing Color | Light Gray RAL 7035 | | |
| Degree of protection | <ul style="list-style-type: none"> ▪ IP 40 on front panel ▪ IP 20 excluding terminal blocks | | |
| Weight | <ul style="list-style-type: none"> ▪ Without packing: 103g (88983903), 97g (88983901), 79g (88983902) ▪ With unitary packing: 119g (88983903), 113g (88983901), 95g (88983902) | | |
| Dimensions | <ul style="list-style-type: none"> ▪ Without packing: 18 x 90 x 69.6 mm (excluding terminal blocks and DIN rail clip) ▪ With unitary packing: 22 x 137 x 74 mm | | |
| Connectors Type | Removable Connectors with compatibility for Screw connectors or Cage Clamp connectors (see installation sheet for compatible connectors recommended) | | |
| DIN rail mounting | Mounting in 35 mm symmetrical DIN rail (see installation sheet of instructions), compatible with modular enclosures | | |
| Panel mounting | Flat panel mounting by screws (see installation sheet of instructions) | | |

| | Millenium Slim CB8R (AC) | Millenium Slim CB8R (DC) | Millenium Slim CB8S (DC) |
|--|--|-----------------------------|-----------------------------|
| Processing Characteristics | | | |
| Part Number | 88983903 | 88983901 | 88983902 |
| HMI / MMI | <ul style="list-style-type: none"> ▪ 1 green Led for Power/Status ▪ 1 blue Led for Bluetooth ▪ Virtual display & keypad with Crouzet Virtual Display or Crouzet Soft | | |
| Programming Software | Crouzet Soft | | |
| Programming method | FBD (Function Block Diagram), including SFC (Sequential Function Chart) (Grafcet) | | |
| Program size | <ul style="list-style-type: none"> ▪ Function blocks: typically 350 blocks (1024 max.) ▪ Macro blocks: 127 max. (255 blocks per macro) | | |
| Program memory | Flash | | |
| Data memory | 2 k octets | | |
| Back-up time (in the event of power failure) | <ul style="list-style-type: none"> ▪ Program and settings in the controller: 10 years ▪ Data memory: 10 years | | |
| Data back-up | Data backup in the flash memory is guaranteed if the product is powered on more than 10 seconds | | |
| Cycle time | From 2 ms* to 90 ms, default value: 10 ms *: Depending on program memory | | |
| Clock data retention | 10 years (lithium battery) at 25 °C (77 °F) | | |
| Clock drift | Drift < 12 min/year (at 25 °C (77 °F)) 6 s / month (at 25 °C (77 °F) with user-definable correction of drift). | | |
| Timer block accuracy | 0.5 % ± 2 cycle time | | |
| Startup time on power up | < 3 s | | |
| Self-test | <ul style="list-style-type: none"> ▪ Test firmware integrity (checksum memory) ▪ Stability of the internal power supply ▪ Check the conformity of the device configuration with the configuration in the application program. | | |

| Power Supply | | | |
|--|---|--|--|
| Part Number | 88983903 | 88983901 | 88983902 |
| Nominal supply voltage | 110 V \sim → 240 V \sim | 24 V --- | |
| Voltage supply tolerance | -15% / +10% | -15% / +20% | |
| Operating limits | 93.5 → 264 V \sim * Accepts temporary overvoltage occurring on the power network | 20.4 → 28.8 V --- * Accepts temporary overvoltage occurring on the power network | |
| AC supply voltage frequency | 50/60Hz (-6% / +5%) so 47Hz → 53Hz / 57 → 63Hz | N/A | |
| Immunity to power micro cuts | ≤ 10 ms (repetition 20 times) | ≤ 1 ms (repetition 20 times) | |
| Max. absorbed power | <ul style="list-style-type: none"> ▪ 6.9 VA @ 240 V\sim ▪ 6 VA @ 240 V\sim I/Os = 0 | <ul style="list-style-type: none"> ▪ 1.2 W @ 24 V--- ▪ 1.56 W @ 28.8 V---, ▪ 0.5 W @ 24 V--- I/Os = 0 | <ul style="list-style-type: none"> ▪ 0.75 W @ 24 V--- ▪ 0.8 W @ 28.8 V---, ▪ 0.5 W @ 24 V--- I/Os = 0 |
| Protection against polarity inversions | Not applicable | Yes | |
| Power monitoring | Yes, but no value available through the application "FB Status" | Yes, and value available through the application "FB Status", 1/10V, 5% of full scale | |

| | Millenium Slim CB8R (AC) | Millenium Slim CB8R (DC) | Millenium Slim CB8S (DC) |
|---|--|--|-----------------------------|
| Inputs | | | |
| Part Number | 88983903 | 88983901 | 88983902 |
| Used as Digital Inputs | | | |
| Quantity | 4 digital inputs -> from I1 to I4 | | |
| Rated voltage | 110 V \sim → 240 V \sim | 24 V --- | |
| Voltage tolerance | -15% / +10% | -15% / +20% | |
| Operating limits | 93.5 → 264 V \sim | 20.4 → 28.8 V --- | |
| Input current | <ul style="list-style-type: none"> ▪ 0.25 mA @ 93.5 V\sim ▪ 0.3 mA @ 110 V\sim ▪ 0.6 mA @ 230 V\sim ▪ 0.7 mA @ 265 V\sim | <ul style="list-style-type: none"> ▪ 1.8 mA @ 20.4 V ▪ 2.1 mA @ 24 V ▪ 2.5 mA @ 28.8 V | |
| Input frequency | 50/60Hz (-6% / +5%) so 47% → 53Hz / 57 → 63Hz | N/A | |
| Input impedance | 559 k Ω | 11.7 k Ω | |
| Logic 1 voltage threshold | \geq 79 V \sim | \geq 11 V --- | |
| Making current at logic state 1 | \geq 0.2 mA | \geq 1 mA | |
| Logic 0 voltage threshold | \leq 45 V \sim | \leq 9 V --- | |
| Release current at logic state 0 | \leq 0.1 mA | \leq 0.8 mA | |
| Response time | 1 to 2 cycle times | | |
| Sensor type | Contact or 3-wire PNP | | |
| Conforming to IEC/EN 61131-2 | Type 1 | | |
| Input type | Resistive | | |
| Isolation between power supply and inputs | None | | |
| Isolation between inputs | None | | |
| Protection against polarity inversions | Not applicable | Yes | |
| Status indicator | Yes, on Virtual Display (CVD & Crouzet Soft) | | |
| Cable length | \leq 30 m | | |
| Used as High-Speed Inputs | | | |
| Quantity | N/A | 2 High-Speed inputs -> from I1 to I2 | |
| Input voltage | N/A | 24 V --- | |
| Voltage tolerance | N/A | -5% / +20% | |
| Operating limits | N/A | 22.8 → 28.8 V --- | |
| Input current | N/A | <ul style="list-style-type: none"> ▪ 1.9 mA @ 22.8 V ▪ 2.1 mA @ 24 V ▪ 2.5 mA @ 28.8 V | |
| Input impedance | N/A | 11.7 k Ω | |
| Logic 1 voltage threshold | N/A | \geq 22.8 V --- | |
| Making current at logic state 1 | N/A | \geq 1.9 mA | |
| Logic 0 voltage threshold | N/A | \leq 12 V --- | |
| Release current at logic state 0 | N/A | \leq 1 mA | |
| Maximum counting frequency | N/A | <ul style="list-style-type: none"> ▪ 2 independent counters: 5 kHz* ▪ Function: UP and DOWN <p>* with a time cycle \leq 10 ms and a ton / toff = 50% \pm 5%, level 0 < 12V and level 1 > 22.8V</p> | |
| Cable length | N/A | \leq 3 m with shielded twisted cable | |

| | Millenium Slim CB8R (AC) | Millenium Slim CB8R (DC) | Millenium Slim CB8S (DC) |
|----------------------------------|-----------------------------|---|-----------------------------|
| Used as PWM Inputs | | | |
| Quantity | N/A | 2 PWM inputs -> from I3 to I4 | |
| Input voltage | N/A | 24 V $\overline{\text{---}}$ | |
| Voltage tolerance | N/A | -5% / +20% | |
| Operating limits | N/A | 22.8 \rightarrow 28.8 V $\overline{\text{---}}$ | |
| Input current | N/A | <ul style="list-style-type: none"> ▪ 1.9 mA @ 22.8 V ▪ 2.1 mA @ 24 V ▪ 2.5 mA @ 28.8 V | |
| Input impedance | N/A | 11.7 k Ω | |
| Logic 1 voltage threshold | N/A | \geq 22.8 V $\overline{\text{---}}$ | |
| Making current at logic state 1 | N/A | \geq 1.9 mA | |
| Logic 0 voltage threshold | N/A | \leq 12 V $\overline{\text{---}}$ | |
| Release current at logic state 0 | N/A | \leq 1 mA | |
| Input frequency | N/A | from 10 Hz to 1 KHz | |
| Restitution | N/A | 0 to 100% duty cycle reading | |
| Accuracy | N/A | 5% with duty cycle between 10% and 90% | |
| Cable length | N/A | \leq 30 m | |

| Used as Analog Inputs | | | |
|---|-----|---|--|
| Quantity | N/A | 4 analog inputs -> from I1 to I4 | |
| Measuring range | N/A | <ul style="list-style-type: none"> ▪ 0 \rightarrow 10 V ▪ 0 \rightarrow V power supply or Voltmeter | |
| Input impedance | N/A | 11.7 k Ω | |
| Maximum value without destruction | N/A | <ul style="list-style-type: none"> ▪ 28.8 V$\overline{\text{---}}$ max for 0 \rightarrow 10 V and 0 \rightarrow V power supply ▪ 30.5 V$\overline{\text{---}}$ max for Voltmeter | |
| Input type | N/A | Common mode | |
| Resolution | N/A | 12 bits at maximum input voltage (10 bits at 10V) | |
| Value of LSB | N/A | 7.03 mV | |
| Conversion time | N/A | Controller cycle time | |
| Maximum error in 0-10V mode | N/A | <ul style="list-style-type: none"> ▪ \pm 3.5 % of full scale at 25 $^{\circ}$C (77 $^{\circ}$F) ▪ \pm 5 % of full scale at 55 $^{\circ}$C (131 $^{\circ}$F) | |
| Maximum error in 0-V power supply mode | N/A | <ul style="list-style-type: none"> ▪ \pm 5 % of full scale at 25 $^{\circ}$C (77 $^{\circ}$F) ▪ \pm 6.2 % of full scale at 55 $^{\circ}$C (131 $^{\circ}$F) | |
| Repeat accuracy at 55 $^{\circ}$ C (131 $^{\circ}$ F) | N/A | \pm 2 % | |
| Voltmeter | N/A | from 0 to 30.5 V Accuracy: \pm 5% of full scale at 25 $^{\circ}$ C (77 $^{\circ}$ F) \pm 6.2 % of full scale at 55 $^{\circ}$ C (131 $^{\circ}$ F) | |
| Isolation between analogue channel and power supply | N/A | None | |
| Protection against polarity inversions | N/A | Yes | |
| Potentiometer control | N/A | 2.2 k Ω / 0.5 W (recommended), 10 K Ω max. | |
| Cable length | N/A | \leq 10 m with shielded twisted cable (sensor not isolated) | |

| | Millenium Slim CB8R (AC) | Millenium Slim CB8R (DC) | Millenium Slim CB8S (DC) |
|--|--|---|-----------------------------|
| Outputs | | | |
| Part Number | 88983903 | 88983901 | 88983902 |
| Relay Outputs | | | |
| Quantity | 4 relay outputs, from O1 to O4 | | N/A |
| Breaking voltage | <ul style="list-style-type: none"> ▪ 30 V$\overline{\text{---}}$ max ▪ 250 V\sim max | | N/A |
| Breaking current in the outputs | <ul style="list-style-type: none"> ▪ @ 25 °C -> O1, O2, O3, & O4: 6A max ▪ @ 40 °C -> O1, O2, O3, & O4: 4A max ▪ @ 55 °C -> O1, O2, O3, & O4: 2A max ▪ @ 60 °C -> O1, O2, O3, & O4: 1.3A max | | N/A |
| Breaking current in the common | <ul style="list-style-type: none"> ▪ @ 25 °C -> C1: 10A max & C2: 8A max ▪ @ 40 °C -> C1 & C2: 8A max ▪ @ 55 °C -> C1 & C2: 4A max ▪ @ 60 °C -> C1 & C2: 2.6A max | | N/A |
| Mechanical life | 10 000 000 operations (cycles) | | N/A |
| Electrical durability | 100 000 operations (cycles) resistive loads, @ 25 °C | | N/A |
| Electrical durability for 100 000 operating cycles | Resistive <ul style="list-style-type: none"> ▪ 24 V$\overline{\text{---}}$ tau = 0 ms: 6 A (UL/CUL: 5A) ▪ 250 V\sim cos phi = 1: 6 A Inductive <ul style="list-style-type: none"> ▪ 1/4 HP 250 V\sim @ 25 °C | | N/A |
| Minimum switching capacity | 100 mA (at minimum voltage of 12V) | | N/A |
| Maximum operating rate | 360 per hour | | N/A |
| Response time | <ul style="list-style-type: none"> ▪ Make = 1 cycle time + 8 ms max ▪ Release = 1 cycle time + 5 ms max | | N/A |
| Isolation between power supply and outputs | Reinforced insulation | | N/A |
| Isolation between outputs | Simple isolation between block C1 / O1 / O2 and C2 / O3 / O4 | | N/A |
| Built-in protections | <ul style="list-style-type: none"> ▪ Against short-circuits: None ▪ Against over voltages and overload: None | | N/A |
| Status indicator | Yes, on Virtual Display (CVD & Crouzet Soft) | | N/A |
| Cable length | ≤ 30 m | | N/A |
| Static (Transistor) Outputs | | | |
| Quantity | N/A | 4 static outputs -> from O1 to O4 | |
| Breaking voltage | N/A | 10 → 28.8 V $\overline{\text{---}}$ | |
| Nominal voltage | N/A | 12 / 24 V $\overline{\text{---}}$ | |
| Nominal breaking current | N/A | 0.5 A | |
| Maximum breaking current | N/A | 0.7 A | |
| Breaking current in the common | N/A | 2.8 A | |
| Voltage drop | N/A | < 2V for I=0.5A | |
| Min. load | N/A | 1 mA | |
| Response time | N/A | <ul style="list-style-type: none"> ▪ Make = 1 cycle time + 60 μs max ▪ Release = 1 cycle time + 60 μs max | |
| Built-in protections | N/A | <ul style="list-style-type: none"> ▪ Against overloads and short-circuits: Yes ▪ Against over voltages (*): Yes (*) In the absence of a volt-free contact between the output of the logic controller and the load ▪ Against inversions of power supply: Yes ▪ Current limitation (min: 1.1A, max: 2.6A, @VCC: 24 V$\overline{\text{---}}$, Rload < 10mOhms) | |

| | Millenium Slim CB8R (AC) | Millenium Slim CB8R (DC) | Millenium Slim CB8S (DC) |
|--|-----------------------------|-----------------------------|--|
| Isolation between power supply and outputs | N/A | | None |
| Isolation between outputs | N/A | | None |
| Wiring | N/A | | PNP (Load Common at 0V) |
| Status indicator | N/A | | Yes, on Virtual Display (CVD & Crouzet Soft) |
| Cable length | N/A | | ≤ 10 m |

| Static PWM Outputs | | | |
|----------------------|-----|--|---|
| Quantity | N/A | | 4 static outputs -> from O1 to O4 |
| PWM frequency | N/A | | 20 Hz to 1500 Hz |
| PWM duty cycle | N/A | | 0 → 100 % |
| PWM Max. error | N/A | | < 2% (de 10% à 90%) |
| Built-in protections | N/A | | <ul style="list-style-type: none"> ▪ Against overloads and short-circuits: Yes ▪ Against over voltages (*): Yes (* In the absence of a volt-free contact between the output of the logic controller and the load ▪ Against inversions of power supply: Yes ▪ Current limitation (min: 1.1A, max: 2.6A, @VCC: 24 V_{DC}, Rload < 10mOhms) |
| Cable length | N/A | | ≤ 10 m |

| | Millenium Slim CB8R (AC) | Millenium Slim CB8R (DC) | Millenium Slim CB8S (DC) |
|--|-----------------------------|-----------------------------|-----------------------------|
| Product Dimensions | | | |
| Side and Front Dimensions | | | |
| Dimensions valid for: 88983903 - 88983901 - 88983902 | | | |

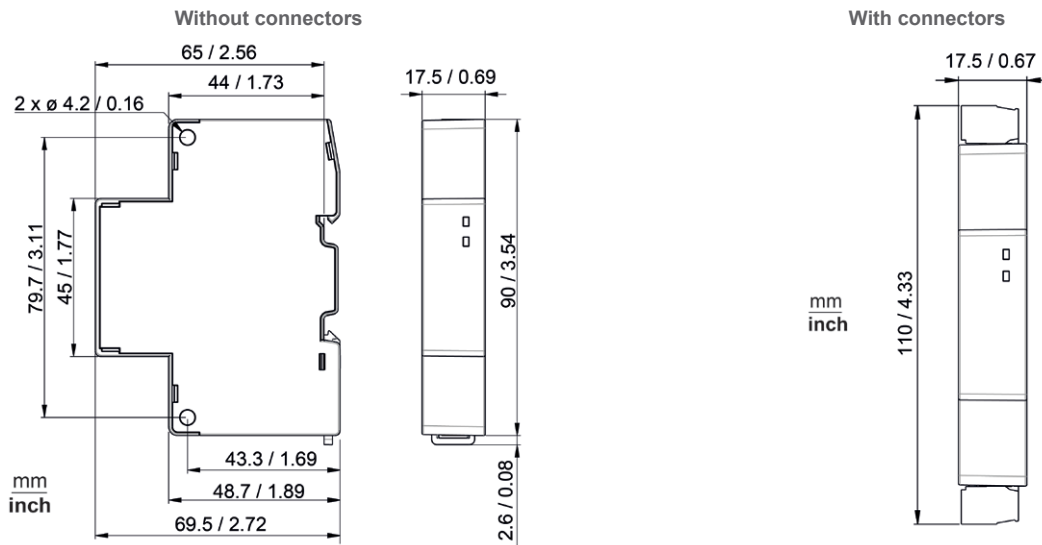

Electronic & Wiring Diagrams

Inputs

Digital Inputs (AC Voltage)

Millenium Slim - Type CB8R AC - 88983903 → Inputs I1, I2, I3 and I4

Electronic Diagram

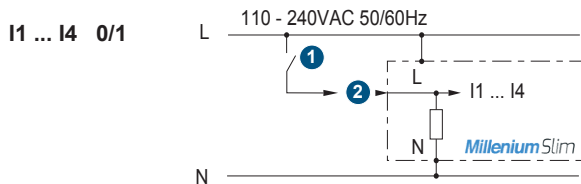

Wiring Diagram

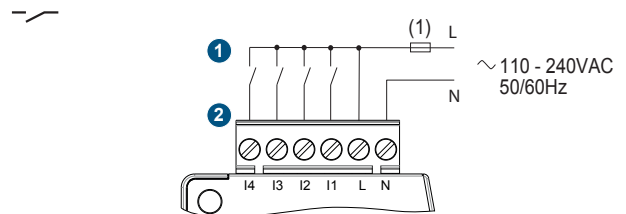

- ① Contact
- ② Digital Input

(1) 1A (UL248) quick blowing fuse, circuit breaker, or circuit protector (US)
L: Line
N: Neutral

I1.. I4: Inputs I1, I2, I3 and I4

Inputs

Digital Inputs (DC Voltage)

Millenium Slim - Type CB8R DC - 88983901 → Inputs I1, I2, I3 and I4

Millenium Slim - Type CB8S DC - 88983902 → Inputs I1, I2, I3 and I4

Electronic Diagram

I1 ... I4 0/1

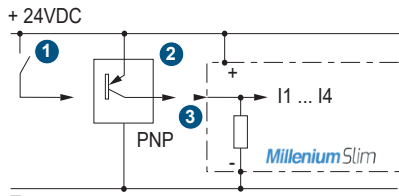

Wiring Diagram

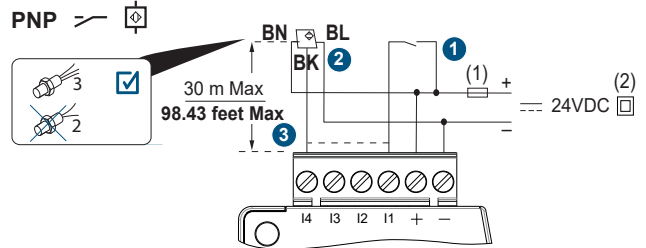

- 1 Contact
- 2 3-wire PNP sensor
- 3 Digital Input

I1.. I4: Inputs I1, I2, I3 and I4

(1) 1A (UL248) quick blowing fuse, circuit breaker, or circuit protector (US)

(2) Isolating source

BN: Brown cable of the 3-Wire PNP sensor

BL: Blue cable of the 3-Wire PNP sensor

BK: Black cable of the 3-Wire PNP sensor

Inputs

High-Speed Inputs (Wiring of 3-wire PNP sensors)

Millenium Slim - Type CB8R DC - 88983901 → Inputs I1 and I2

Millenium Slim - Type CB8S DC - 88983902 → Inputs I1 and I2

Electronic Diagram

I1, I2

HIGH SPEED

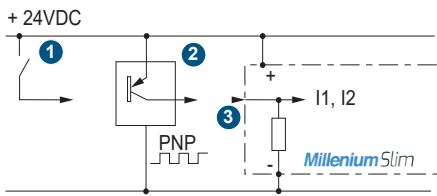

Wiring Diagram

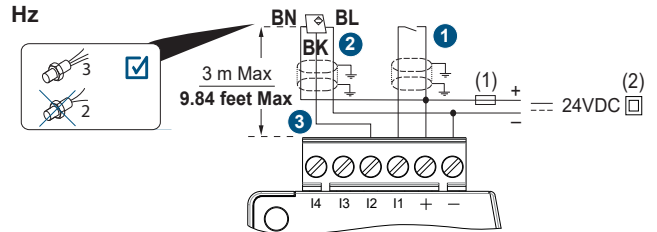

- 1 Contact
- 2 3-wire PNP sensor
- 3 Digital Input

I1, I2: Inputs I1 and I2

(1) 1A (UL248) quick blowing fuse, circuit breaker, or circuit protector (US)

(2) Isolating source

BN: Brown cable of the 3-Wire PNP sensor

BL: Blue cable of the 3-Wire PNP sensor

BK: Black cable of the 3-Wire PNP sensor

Inputs

High-Speed Inputs (Wiring of Encoders)

Millenium Slim - Type CB8R DC - 88983901 → Inputs I1 and I2
 Millenium Slim - Type CB8S DC - 88983902 → Inputs I1 and I2

Electronic Diagram

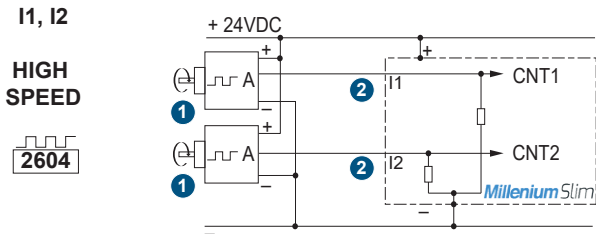

- 1 Encoder
- 2 High-Speed Input

I1, I2: Inputs I1 and I2

Wiring Diagram

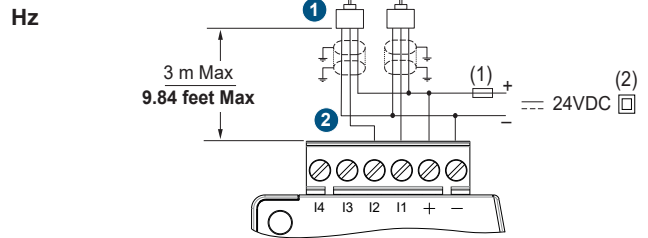

- (1) 1A (UL248) quick blowing fuse, circuit breaker, or circuit protector (US)
- (2) Isolating source

Inputs

PWM Inputs

Millenium Slim - Type CB8R DC - 88983901 → Inputs I3 and I4
 Millenium Slim - Type CB8S DC - 88983902 → Inputs I3 and I4

Electronic Diagram

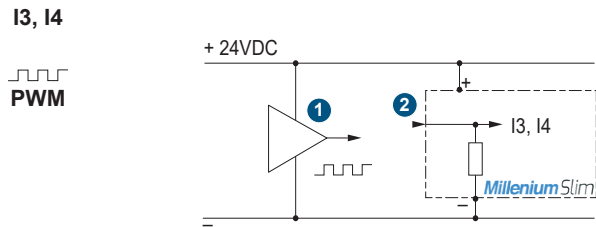

- 1 PWM Source
- 2 PWM Inputs

I3, I4: Inputs I3 and I4

Wiring Diagram

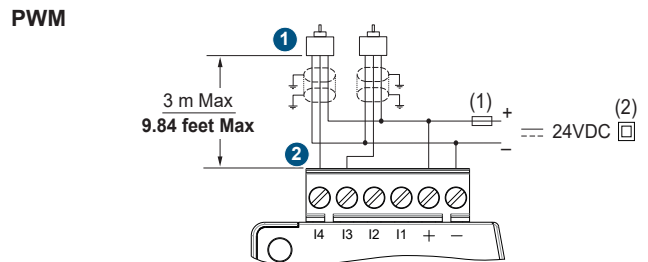

- (1) 1A (UL248) quick blowing fuse, circuit breaker, or circuit protector (US)
- (2) Isolating source

Inputs

Analog Inputs

Millenium Slim - Type CB8R DC - 88983901 → Inputs I1, I2, I3 and I4

Millenium Slim - Type CB8S DC - 88983902 → Inputs I1, I2, I3 and I4

Electronic Diagram

I1 ... I4 U

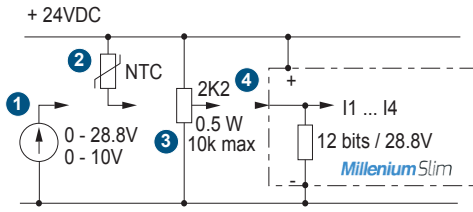

Wiring Diagram

28.8 V, NTC, R

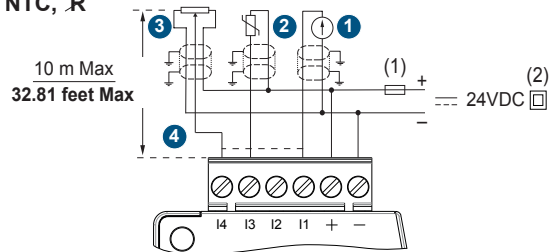

- 1 0-10 V
- 2 NTC Probe
- 3 Potentiometer
- 4 Analog Input

- (1) 1A (UL248) quick blowing fuse, circuit breaker, or circuit protector (US)
- (2) Isolating source

I1... I4: Inputs I1, I2, I3 and I4

Outputs

Relay Outputs

Millenium Slim - Type CB8R AC - 88983903 → Outputs O1, O2, O3 and O4

Millenium Slim - Type CB8R DC - 88983901 → Outputs O1, O2, O3 and O4

Electronic Diagram

O1 ... O4

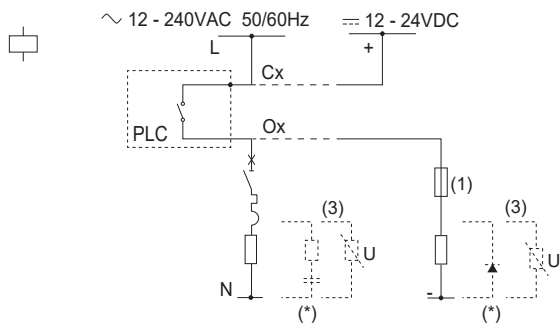

Wiring Diagram

6 A

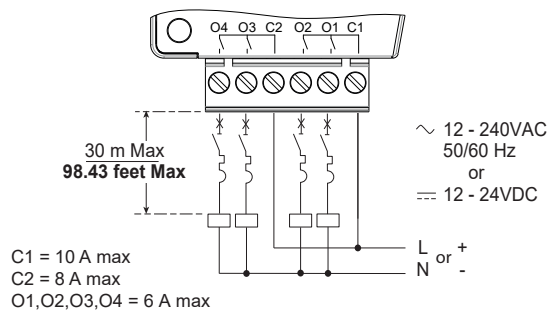

- C1 = 10 A max
- C2 = 8 A max
- O1, O2, O3, O4 = 6 A max

(*) Protection
*PLC: Millenium Slim Logic Controller

Common limits currents
O1+O2= 10A max @25C (8A @40C, 4A @55C, 2.6 @ 60C)
O3+O4=8A max @25C (8A @40C, 4A @ 55C, 2.6 @ 60C)

Outputs

Static / PWM Outputs

Millenium Slim - Type CB8S DC - 88983902 → Outputs O1, O2, O3 and O4

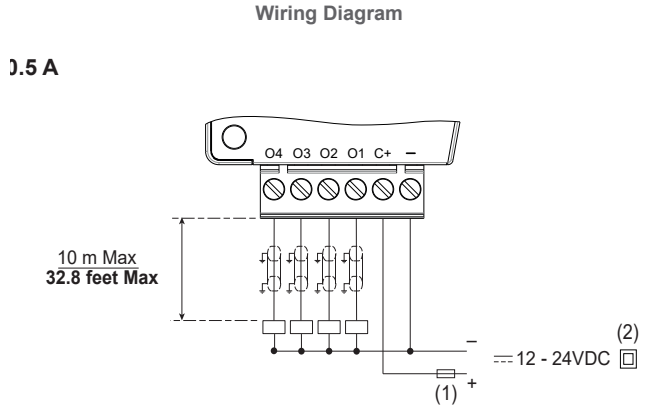
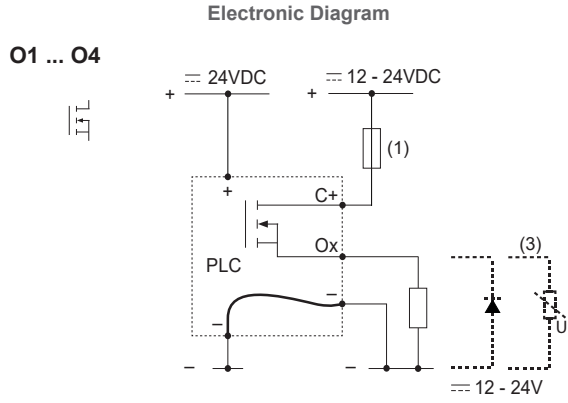

(3) Inductive load
 *PLC: Millenium Slim Logic Controller

(1) 1A (UL248) quick-blowing fuse, circuit-breaker, or circuit protector (US)
 (2) Isolating source

Accessories

BLUETOOTH DONGLE



| Description | Part Number |
|--|-----------------|
| USB Dongle Bluetooth, CE, FCC and IC certified | 88980124 |

SIGNAL CONVERTER



| Description | Part Number |
|-------------------|-----------------|
| 0-20 mA to 0-10 V | 88950108 |

TEMPERATURE PROBES



| Description | Part Number |
|-----------------|-----------------|
| NTC2, PVC probe | 89750174 |



| | |
|-----------------|-----------------|
| NTC1, TPE probe | 89750180 |
|-----------------|-----------------|



| | |
|------------------|-----------------|
| NTC2, INOX probe | 89750182 |
|------------------|-----------------|



| | |
|-----------------|-----------------|
| NTC2, POM probe | 89750185 |
|-----------------|-----------------|



| | |
|----------------------|-----------------|
| NTC3, SILICONE probe | 89750186 |
|----------------------|-----------------|

TEMPERATURE CONVERTERS



| Description | Part Number |
|----------------------------|-----------------|
| Pt1000 3-wire | 88950150 |
| Pt100 3-wire (-40 → +40°C) | 88950151 |
| Pt100 3-wire (0 → +100°C) | 88950152 |
| Pt100 3-wire (0 → +250°C) | 88950153 |
| Thermocouple J | 88950154 |
| Thermocouple K | 88950155 |

POWER SUPPLIES



| Description | Part Number |
|----------------|-----------------|
| Modular of 10W | 89451001 |



| | |
|----------------|-----------------|
| Modular of 30W | 89451003 |
|----------------|-----------------|



| | |
|----------------|-----------------|
| Modular of 60W | 89451006 |
|----------------|-----------------|



| | |
|-----------------|-----------------|
| Modular of 100W | 89451010 |
|-----------------|-----------------|

TEMPERATURE SENSORS



| Description | Part Number |
|-------------|-----------------|
| Air Sensor | 89750190 |



| | |
|------------|-----------------|
| Duct Probe | 89750191 |
|------------|-----------------|



| | |
|----------------|-----------------|
| External Probe | 89750192 |
|----------------|-----------------|



| | |
|--------------------|-----------------|
| Remote/Submersible | 89750193 |
|--------------------|-----------------|

Warning:

The product information contained in this catalogue is given purely as information and does not constitute a representation, warranty or any form of contractual commitment. Crouzet and its subsidiaries reserve the right to modify their products without notice. It is imperative that we should be consulted over any particular use or application of our products and it is the responsibility of the buyer to establish, particularly through all the appropriate tests, that the product is suitable for the use or application. Under no circumstances will our warranty apply, nor shall we be held responsible for any application (such as any modification, addition, deletion, use in conjunction with other electrical or electronic components, circuits or assemblies, or any other unsuitable material or substance) which has not been expressly agreed by us prior to the sale of our products.

X-ON Electronics

Largest Supplier of Electrical and Electronic Components

Click to view similar products for [Bluetooth Modules - 802.15.1 category](#):

Click to view products by [Crouzet manufacturer](#):

Other Similar products are found below :

[A2541R24A10GM](#) [CYBLE-212023-10](#) [BM78SPP05MC2-0002AA](#) [CYW20732S](#) [968EMB0019](#) [E73-2G4M08S1CX](#) [TB-03F](#) [TB-03F-AT_Mesh](#) [SPB228-D-1](#) [88980124](#) [NINA-B222-03B](#) [1327](#) [RN42HID-I/RM](#) [ENW-89829C3KF](#) [BLE113-A-V1](#) [SPBTLE-RFTR](#) [BM70BLE01FC2-0B03AA](#) [ACN52832](#) [A2541E24A10GM](#) [450-0168R](#) [MOTG-BLUETOOTH](#) [ABBTM-2.4GHz-52-T](#) [ABBTM-2.4GHz-T](#) [ABBTM-2.4GHz-T2](#) [ACN52840](#) [4076](#) [4077](#) [AFERO-BL24-01](#) [BLED112](#) [BM62SPKS1MC2-0001AA](#) [BM78SPPS5MC2-0002AA](#) [PX0880/1](#) [DAT12](#) [DG100 IOT EDGE GATEWAY](#) [ENW49D01A1KF](#) [ENW89857A1KF](#) [BT680F](#) [PBA31309V1.00 S](#) [LK64](#) [LSD4BT-E66ALSP001](#) [ATSAMB11-MR510CA](#) [BM20SPKA1NBC-0001AA](#) [BM20SPKS1NBC-0001AA](#) [BM23SPKS1NB9-0B02AA](#) [BM70BLE01FC2-0B04AA](#) [BM77SPP03MC2-0007AA](#) [BM77SPP03MC2-0008AA](#) [BM78SPPS5NC2-0002AA](#) [BM83SM1-00TA](#) [DM164146](#) [RN42N-I/RM](#)