

› Logic Controller Millenium Slim

- › A logic controller in a 17.5 mm (0.69") width
- › DIN rail mount and panel mount
- › 8 I/Os: 4 digital inputs (convertibles to analog in DC versions) and 4 digital outputs (relay or static)
- › Highspeed & PWM inputs available in DC versions, PWM outputs available in static versions
- › DC (24V) and AC (110-240V) power supply available
- › Removable connectors
- › Wireless Bluetooth to communicate with other MilleniumSlim logic controllers, retrieve datalog and program transfer
- › Virtual display possible in mobile devices trough Crouzet app
- › Intuitive & easy-to-use graphical programming software (FBD)
- › Certified CE, cULus Listed, NOM, RCM, SCM, UKCA



Millenium Slim

Product Selection								
Type	Total I/Os	Input	Output	Supply Voltage	Communication	Screen	Connectors	Part Number
CB8R (AC)	8	4 Inputs › 4 x Digital	4 Outputs › 4 x 6 A Relay	110-240 V~	Bluetooth Embedded	Via App: Crouzet Virtual Display	Included	88983903
CB8R (DC)		4 Inputs › 2 x Convertibles to	4 Outputs › 4 x 6 A Relay	24 VDC				88983901
CB8S (DC)		<ul style="list-style-type: none"> ▪ Digital ▪ Analog ▪ High-Speed › 2 x Convertibles to <ul style="list-style-type: none"> ▪ Digital ▪ Analog ▪ PWM 	4 Outputs › 4 x 0.5 A Static (Transistor - Sourcing)					88983902

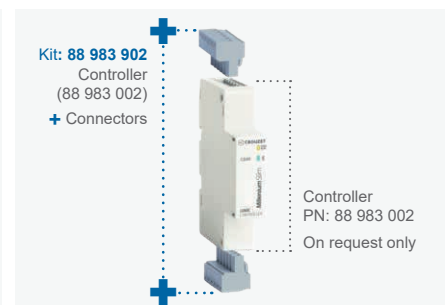
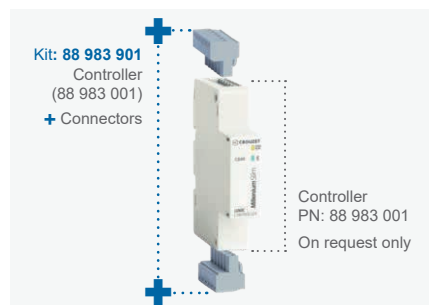
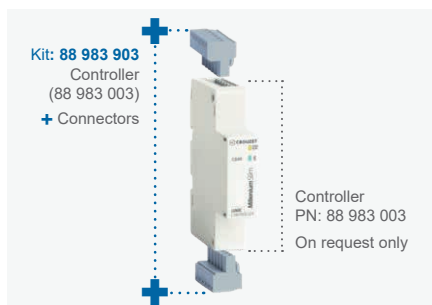

You have a project? Contact us on www.crouzet.com

Description:

Millenium Slim: The smallest logic controller ever!

Designed for **space reduction** in any control panel or machine thanks to its 17.5 mm (0.69") body, this multipurpose industrial logic controller with 8 highly configurable I/Os, can replace dozens of control panel products, and will give **wireless capabilities** to your applications via Bluetooth. Powered by the **easiest-to-use** and free programming software "CrouzetSoft", a virtual display from any smartphone or PC, remote program transferring and plenty of pre-programmed applications ready to quick-start your next small-scale automation project.

For more information about **Millenium Slim**, please visit www.crouzet.com.

	Millenium Slim CB8R (AC)	Millenium Slim CB8R (DC)	Millenium Slim CB8S (DC)
General Characteristics			
Part Number	88983903	88983901	88983902
Safety certifications	CE, cULus Listed, NOM, RCM, SCM, UKCA		
Environmental certifications	Reach, RoHS		
Conformity with programmable controllers' standard	CEI/EN 61131-2 (Open equipment)		
Conformity with the RADIO directive (in accordance with 2014/53/UE)	<ul style="list-style-type: none"> ▪ EN 61010-1 & EN 61010-2-201: Safety requirements ▪ EN 301489-1 & EN 301489-17: EMC requirements ▪ EN 61000-6-1, EN 61000-6-2, EN 61000-6-3 & EN 61000-6-4: EMC requirements ▪ EN 300328: Radio requirements ▪ EN62311: Health requirements 		
Power supply earthing	None		
Overvoltage category	II (in accordance with IEC/EN 60664-1)		
Pollution Degree	2 (in accordance with IEC/EN 61131-2)		
Maximum utilization altitude	<ul style="list-style-type: none"> ▪ Operation: 2000 m ▪ Transport: 3000 m 		
Mechanical resistance	<ul style="list-style-type: none"> ▪ Immunity to vibrations IEC/EN 60068-2-6, Fc test ▪ Immunity to shock IEC/EN 60068-2-27, Ea test ▪ Degrees of protection provided by enclosures of electrical equipment against external mechanical impacts CEI62262: IK07 (test method: 500G steel ball drop, 40cm high) 		
Resistance to electrostatic discharge	Immunity to ESD IEC/EN 61000-4-2, level 3		
Resistance to HF interference (Immunity)	<ul style="list-style-type: none"> ▪ Immunity to radiated electrostatic fields IEC/EN 61000-4-3, level 3 ▪ Immunity to fast transients (burst immunity) IEC/EN 61000-4-4, level 3 ▪ Immunity to shock waves IEC/EN 61000-4-5 ▪ Radio frequency in common mode IEC/EN 61000-4-6, level 3 		
Conducted and radiated emissions (in accordance with EN 55032)	Class B		
Bluetooth protocol	Bluetooth ≥ V5.0		
Bluetooth range	≤ 10 m (max. 20 m in free fields)		
Operating temperature	Ventilated enclosure: -20 °C (-4 °F) to +60 °C (140 °F) Non-ventilated enclosure: -20 °C (-4 °F) to +40 °C (104 °F) UL: maximum surrounding air: +50 °C (122 °F)		
Storage temperature	-40 °C (-40 °F) to +80 °C (176 °F)		
Humidity	95% max. (no condensation or dripping water)		
Connecting capacity	<ul style="list-style-type: none"> ▪ Flexible wire with ferrule: 1 conductor: 0.25 to 2.5 mm² ▪ Flexible wire with ferrule: 2 conductors: 0.25 to 1 mm² (1.5 mm² with ferrule TWIN) ▪ Rigid wire: 1 conductor: 0.2 to 2.5 mm² ▪ Rigid wire: 2 conductors: 0.2 to 1 mm² ▪ Tightening torque: 0.5 N.m (4.5 lb-in) (screw M3, tighten using a flat screwdriver) ▪ Stripping length: 7 mm 		
Housing material	Makrolon, UL94V0		
Housing Color	Light Gray RAL 7035		
Degree of protection	<ul style="list-style-type: none"> ▪ IP 40 on front panel ▪ IP 20 excluding terminal blocks 		
Weight	<ul style="list-style-type: none"> ▪ Without packing: 103g (88983903), 97g (88983901), 79g (88983902) ▪ With unitary packing: 119g (88983903), 113g (88983901), 95g (88983902) 		
Dimensions	<ul style="list-style-type: none"> ▪ Without packing: 18 x 90 x 69.6 mm (excluding terminal blocks and DIN rail clip) ▪ With unitary packing: 22 x 137 x 74 mm 		
Connectors Type	Removable Connectors with compatibility for Screw connectors or Cage Clamp connectors (see installation sheet for compatible connectors recommended)		
DIN rail mounting	Mounting in 35 mm symmetrical DIN rail (see installation sheet of instructions), compatible with modular enclosures		
Panel mounting	Flat panel mounting by screws (see installation sheet of instructions)		

	Millenium Slim CB8R (AC)	Millenium Slim CB8R (DC)	Millenium Slim CB8S (DC)
Processing Characteristics			
Part Number	88983903	88983901	88983902
HMI / MMI	<ul style="list-style-type: none"> ▪ 1 green Led for Power/Status ▪ 1 blue Led for Bluetooth ▪ Virtual display & keypad with Crouzet Virtual Display or Crouzet Soft 		
Programming Software	Crouzet Soft		
Programming method	FBD (Function Block Diagram), including SFC (Sequential Function Chart) (Grafcet)		
Program size	<ul style="list-style-type: none"> ▪ Function blocks: typically 350 blocks (1024 max.) ▪ Macro blocks: 127 max. (255 blocks per macro) 		
Program memory	Flash		
Data memory	2 k octets		
Back-up time (in the event of power failure)	<ul style="list-style-type: none"> ▪ Program and settings in the controller: 10 years ▪ Data memory: 10 years 		
Data back-up	Data backup in the flash memory is guaranteed if the product is powered on more than 10 seconds		
Cycle time	From 2 ms* to 90 ms, default value: 10 ms *: Depending on program memory		
Clock data retention	10 years (lithium battery) at 25 °C (77 °F)		
Clock drift	Drift < 12 min/year (at 25 °C (77 °F)) 6 s / month (at 25 °C (77 °F) with user-definable correction of drift).		
Timer block accuracy	0.5 % ± 2 cycle time		
Startup time on power up	< 3 s		
Self-test	<ul style="list-style-type: none"> ▪ Test firmware integrity (checksum memory) ▪ Stability of the internal power supply ▪ Check the conformity of the device configuration with the configuration in the application program. 		

Power Supply			
Part Number	88983903	88983901	88983902
Nominal supply voltage	110 V \sim → 240 V \sim	24 V ---	
Voltage supply tolerance	-15% / +10%	-15% / +20%	
Operating limits	93.5 → 264 V \sim * Accepts temporary overvoltage occurring on the power network	20.4 → 28.8 V --- * Accepts temporary overvoltage occurring on the power network	
AC supply voltage frequency	50/60Hz (-6% / +5%) so 47Hz → 53Hz / 57 → 63Hz	N/A	
Immunity to power micro cuts	≤ 10 ms (repetition 20 times)	≤ 1 ms (repetition 20 times)	
Max. absorbed power	<ul style="list-style-type: none"> ▪ 6.9 VA @ 240 V\sim ▪ 6 VA @ 240 V\sim I/Os = 0 	<ul style="list-style-type: none"> ▪ 1.2 W @ 24 V--- ▪ 1.56 W @ 28.8 V---, ▪ 0.5 W @ 24 V--- I/Os = 0 	<ul style="list-style-type: none"> ▪ 0.75 W @ 24 V--- ▪ 0.8 W @ 28.8 V---, ▪ 0.5 W @ 24 V--- I/Os = 0
Protection against polarity inversions	Not applicable	Yes	
Power monitoring	Yes, but no value available through the application "FB Status"	Yes, and value available through the application "FB Status", 1/10V, 5% of full scale	

	Millenium Slim CB8R (AC)	Millenium Slim CB8R (DC)	Millenium Slim CB8S (DC)
Inputs			
Part Number	88983903	88983901	88983902
Used as Digital Inputs			
Quantity	4 digital inputs -> from I1 to I4		
Rated voltage	110 V~ → 240 V~	24 V---	
Voltage tolerance	-15% / +10%	-15% / +20%	
Operating limits	93.5 → 264 V~	20.4 → 28.8 V---	
Input current	<ul style="list-style-type: none"> ▪ 0.25 mA @ 93.5 V~ ▪ 0.3 mA @ 110 V~ ▪ 0.6 mA @ 230 V~ ▪ 0.7 mA @ 265 V~ 	<ul style="list-style-type: none"> ▪ 1.8 mA @ 20.4 V ▪ 2.1 mA @ 24 V ▪ 2.5 mA @ 28.8 V 	
Input frequency	50/60Hz (-6% / +5%) so 47% → 53Hz / 57 → 63Hz	N/A	
Input impedance	559 kΩ	11.7 kΩ	
Logic 1 voltage threshold	≥ 79 V~	≥ 11 V---	
Making current at logic state 1	≥ 0.2 mA	≥ 1 mA	
Logic 0 voltage threshold	≤ 45 V~	≤ 9 V---	
Release current at logic state 0	≤ 0.1 mA	≤ 0.8 mA	
Response time	1 to 2 cycle times		
Sensor type	Contact or 3-wire PNP		
Conforming to IEC/EN 61131-2	Type 1		
Input type	Resistive		
Isolation between power supply and inputs	None		
Isolation between inputs	None		
Protection against polarity inversions	Not applicable	Yes	
Status indicator	Yes, on Virtual Display (CVD & Crouzet Soft)		
Cable length	≤ 30 m		

Used as High-Speed Inputs			
Quantity	N/A	2 High-Speed inputs -> from I1 to I2	
Input voltage	N/A	24 V---	
Voltage tolerance	N/A	-5% / +20%	
Operating limits	N/A	22.8 → 28.8 V---	
Input current	N/A	<ul style="list-style-type: none"> ▪ 1.9 mA @ 22.8 V ▪ 2.1 mA @ 24 V ▪ 2.5 mA @ 28.8 V 	
Input impedance	N/A	11.7 kΩ	
Logic 1 voltage threshold	N/A	≥ 22.8 V---	
Making current at logic state 1	N/A	≥ 1.9 mA	
Logic 0 voltage threshold	N/A	≤ 12 V---	
Release current at logic state 0	N/A	≤ 1 mA	
Maximum counting frequency	N/A	<ul style="list-style-type: none"> ▪ 2 independent counters: 5 kHz* ▪ Function: UP and DOWN <p>* with a time cycle ≤ 10 ms and a ton / toff = 50% ± 5%, level 0 < 12V and level 1 > 22.8V</p>	
Cable length	N/A	≤ 3 m with shielded twisted cable	

	Millenium Slim CB8R (AC)	Millenium Slim CB8R (DC)	Millenium Slim CB8S (DC)
Used as PWM Inputs			
Quantity	N/A	2 PWM inputs -> from I3 to I4	
Input voltage	N/A	24 V $\overline{\text{---}}$	
Voltage tolerance	N/A	-5% / +20%	
Operating limits	N/A	22.8 \rightarrow 28.8 V $\overline{\text{---}}$	
Input current	N/A	<ul style="list-style-type: none"> ▪ 1.9 mA @ 22.8 V ▪ 2.1 mA @ 24 V ▪ 2.5 mA @ 28.8 V 	
Input impedance	N/A	11.7 k Ω	
Logic 1 voltage threshold	N/A	\geq 22.8 V $\overline{\text{---}}$	
Making current at logic state 1	N/A	\geq 1.9 mA	
Logic 0 voltage threshold	N/A	\leq 12 V $\overline{\text{---}}$	
Release current at logic state 0	N/A	\leq 1 mA	
Input frequency	N/A	from 10 Hz to 1 KHz	
Restitution	N/A	0 to 100% duty cycle reading	
Accuracy	N/A	5% with duty cycle between 10% and 90%	
Cable length	N/A	\leq 30 m	

Used as Analog Inputs			
Quantity	N/A	4 analog inputs -> from I1 to I4	
Measuring range	N/A	<ul style="list-style-type: none"> ▪ 0 \rightarrow 10 V ▪ 0 \rightarrow V power supply or Voltmeter 	
Input impedance	N/A	11.7 k Ω	
Maximum value without destruction	N/A	<ul style="list-style-type: none"> ▪ 28.8 V$\overline{\text{---}}$ max for 0 \rightarrow 10 V and 0 \rightarrow V power supply ▪ 30.5 V$\overline{\text{---}}$ max for Voltmeter 	
Input type	N/A	Common mode	
Resolution	N/A	12 bits at maximum input voltage (10 bits at 10V)	
Value of LSB	N/A	7.03 mV	
Conversion time	N/A	Controller cycle time	
Maximum error in 0-10V mode	N/A	<ul style="list-style-type: none"> ▪ \pm 3.5 % of full scale at 25 $^{\circ}$C (77 $^{\circ}$F) ▪ \pm 5 % of full scale at 55 $^{\circ}$C (131 $^{\circ}$F) 	
Maximum error in 0-V power supply mode	N/A	<ul style="list-style-type: none"> ▪ \pm 5 % of full scale at 25 $^{\circ}$C (77 $^{\circ}$F) ▪ \pm 6.2 % of full scale at 55 $^{\circ}$C (131 $^{\circ}$F) 	
Repeat accuracy at 55 $^{\circ}$ C (131 $^{\circ}$ F)	N/A	\pm 2 %	
Voltmeter	N/A	from 0 to 30.5 V Accuracy: \pm 5% of full scale at 25 $^{\circ}$ C (77 $^{\circ}$ F) \pm 6.2 % of full scale at 55 $^{\circ}$ C (131 $^{\circ}$ F)	
Isolation between analogue channel and power supply	N/A	None	
Protection against polarity inversions	N/A	Yes	
Potentiometer control	N/A	2.2 k Ω / 0.5 W (recommended), 10 K Ω max.	
Cable length	N/A	\leq 10 m with shielded twisted cable (sensor not isolated)	

	Millenium Slim CB8R (AC)	Millenium Slim CB8R (DC)	Millenium Slim CB8S (DC)
Outputs			
Part Number	88983903	88983901	88983902
Relay Outputs			
Quantity	4 relay outputs, from O1 to O4		N/A
Breaking voltage	<ul style="list-style-type: none"> ▪ 30 V$\overline{\text{---}}$ max ▪ 250 V\sim max 		N/A
Breaking current in the outputs	<ul style="list-style-type: none"> ▪ @ 25 °C -> O1, O2, O3, & O4: 6A max ▪ @ 40 °C -> O1, O2, O3, & O4: 4A max ▪ @ 55 °C -> O1, O2, O3, & O4: 2A max ▪ @ 60 °C -> O1, O2, O3, & O4: 1.3A max 		N/A
Breaking current in the common	<ul style="list-style-type: none"> ▪ @ 25 °C -> C1: 10A max & C2: 8A max ▪ @ 40 °C -> C1 & C2: 8A max ▪ @ 55 °C -> C1 & C2: 4A max ▪ @ 60 °C -> C1 & C2: 2.6A max 		N/A
Mechanical life	10 000 000 operations (cycles)		N/A
Electrical durability	100 000 operations (cycles) resistive loads, @ 25 °C		N/A
Electrical durability for 100 000 operating cycles	Resistive <ul style="list-style-type: none"> ▪ 24 V$\overline{\text{---}}$ tau = 0 ms: 6 A (UL/CUL: 5A) ▪ 250 V\sim cos phi = 1: 6 A Inductive <ul style="list-style-type: none"> ▪ 1/4 HP 250 V\sim @ 25 °C 		N/A
Minimum switching capacity	100 mA (at minimum voltage of 12V)		N/A
Maximum operating rate	360 per hour		N/A
Response time	<ul style="list-style-type: none"> ▪ Make = 1 cycle time + 8 ms max ▪ Release = 1 cycle time + 5 ms max 		N/A
Isolation between power supply and outputs	Reinforced insulation		N/A
Isolation between outputs	Simple isolation between block C1 / O1 / O2 and C2 / O3 / O4		N/A
Built-in protections	<ul style="list-style-type: none"> ▪ Against short-circuits: None ▪ Against over voltages and overload: None 		N/A
Status indicator	Yes, on Virtual Display (CVD & Crouzet Soft)		N/A
Cable length	≤ 30 m		N/A
Static (Transistor) Outputs			
Quantity	N/A	4 static outputs -> from O1 to O4	
Breaking voltage	N/A	10 → 28.8 V $\overline{\text{---}}$	
Nominal voltage	N/A	12 / 24 V $\overline{\text{---}}$	
Nominal breaking current	N/A	0.5 A	
Maximum breaking current	N/A	0.7 A	
Breaking current in the common	N/A	2.8 A	
Voltage drop	N/A	< 2V for I=0.5A	
Min. load	N/A	1 mA	
Response time	N/A	<ul style="list-style-type: none"> ▪ Make = 1 cycle time + 60 μs max ▪ Release = 1 cycle time + 60 μs max 	
Built-in protections	N/A	<ul style="list-style-type: none"> ▪ Against overloads and short-circuits: Yes ▪ Against over voltages (*): Yes (*) In the absence of a volt-free contact between the output of the logic controller and the load ▪ Against inversions of power supply: Yes ▪ Current limitation (min: 1.1A, max: 2.6A, @VCC: 24 V$\overline{\text{---}}$, Rload < 10mOhms) 	

	Millenium Slim CB8R (AC)	Millenium Slim CB8R (DC)	Millenium Slim CB8S (DC)
Isolation between power supply and outputs	N/A		None
Isolation between outputs	N/A		None
Wiring	N/A		PNP (Load Common at 0V)
Status indicator	N/A		Yes, on Virtual Display (CVD & Crouzet Soft)
Cable length	N/A		≤ 10 m

Static PWM Outputs			
Quantity	N/A		4 static outputs -> from O1 to O4
PWM frequency	N/A		20 Hz to 1500 Hz
PWM duty cycle	N/A		0 → 100 %
PWM Max. error	N/A		< 2% (de 10% à 90%)
Built-in protections	N/A		<ul style="list-style-type: none"> ▪ Against overloads and short-circuits: Yes ▪ Against over voltages (*): Yes (* In the absence of a volt-free contact between the output of the logic controller and the load ▪ Against inversions of power supply: Yes ▪ Current limitation (min: 1.1A, max: 2.6A, @VCC: 24 V_{DC}, Rload < 10mOhms)
Cable length	N/A		≤ 10 m

	Millenium Slim CB8R (AC)	Millenium Slim CB8R (DC)	Millenium Slim CB8S (DC)
Product Dimensions			
Side and Front Dimensions			
Dimensions valid for: 88983903 - 88983901 - 88983902			

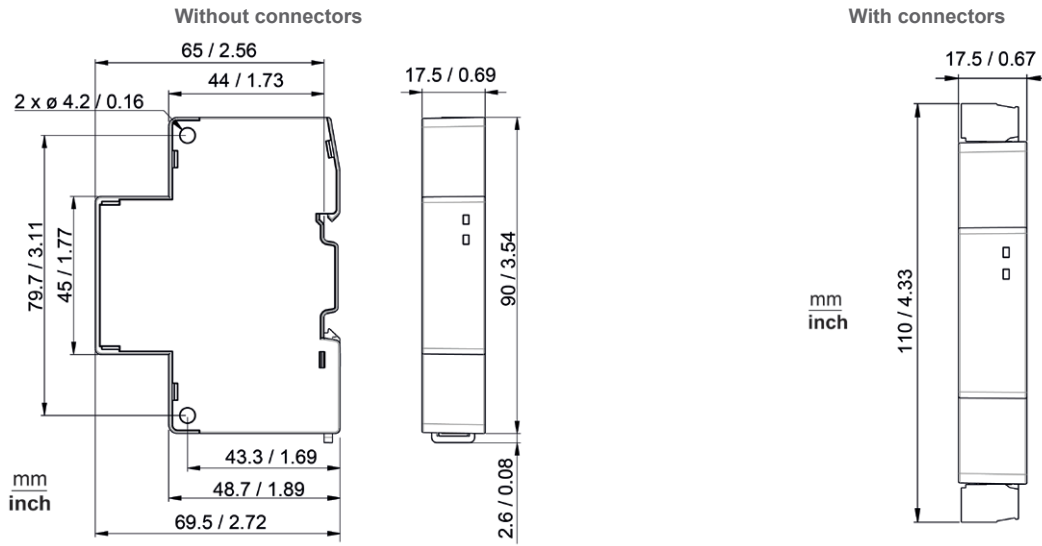

Electronic & Wiring Diagrams

Inputs

Digital Inputs (AC Voltage)

Millenium Slim - Type CB8R AC - 88983903 → Inputs I1, I2, I3 and I4

Electronic Diagram

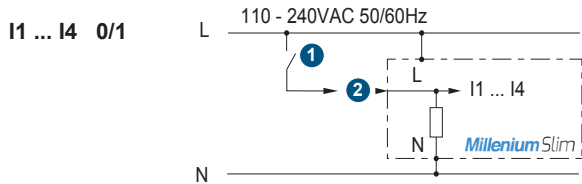

Wiring Diagram

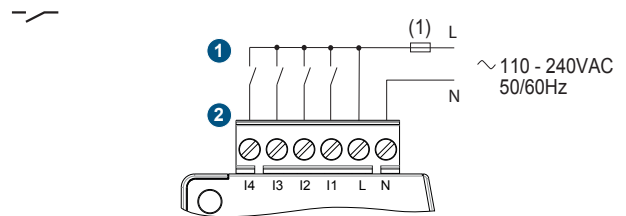

- ① Contact
- ② Digital Input

(1) 1A (UL248) quick blowing fuse, circuit breaker, or circuit protector (US)
 L: Line
 N: Neutral

I1.. I4: Inputs I1, I2, I3 and I4

Inputs
Digital Inputs (DC Voltage)

Millenium Slim - Type CB8R DC - 88983901 → Inputs I1, I2, I3 and I4
 Millenium Slim - Type CB8S DC - 88983902 → Inputs I1, I2, I3 and I4

Electronic Diagram

I1 ... I4 0/1

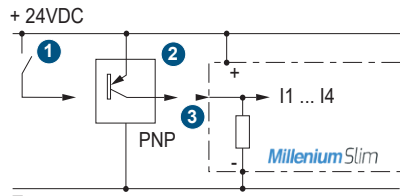

Wiring Diagram

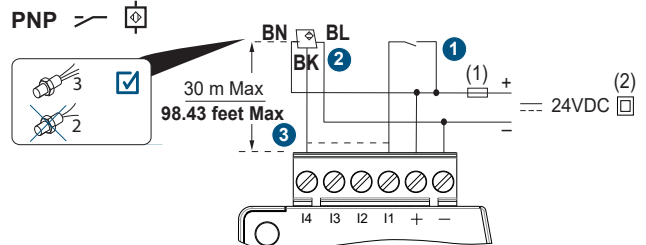

- 1 Contact
- 2 3-wire PNP sensor
- 3 Digital Input

I1.. I4: Inputs I1, I2, I3 and I4

- (1) 1A (UL248) quick blowing fuse, circuit breaker, or circuit protector (US)
- (2) Isolating source
- BN: Brown cable of the 3-Wire PNP sensor
- BL: Blue cable of the 3-Wire PNP sensor
- BK: Black cable of the 3-Wire PNP sensor

Inputs
High-Speed Inputs (Wiring of 3-wire PNP sensors)

Millenium Slim - Type CB8R DC - 88983901 → Inputs I1 and I2
 Millenium Slim - Type CB8S DC - 88983902 → Inputs I1 and I2

Electronic Diagram

I1, I2

HIGH SPEED



2604

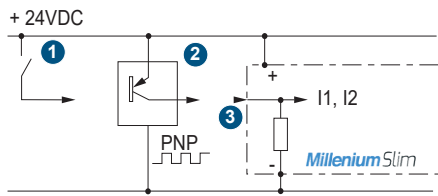

Wiring Diagram

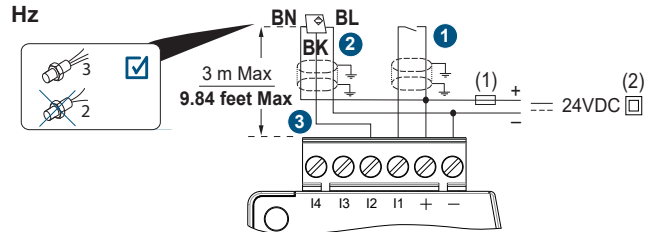

- 1 Contact
- 2 3-wire PNP sensor
- 3 Digital Input

I1, I2: Inputs I1 and I2

- (1) 1A (UL248) quick blowing fuse, circuit breaker, or circuit protector (US)
- (2) Isolating source
- BN: Brown cable of the 3-Wire PNP sensor
- BL: Blue cable of the 3-Wire PNP sensor
- BK: Black cable of the 3-Wire PNP sensor

Inputs
High-Speed Inputs (Wiring of Encoders)

Millenium Slim - Type CB8R DC - 88983901 → Inputs I1 and I2
 Millenium Slim - Type CB8S DC - 88983902 → Inputs I1 and I2

Electronic Diagram

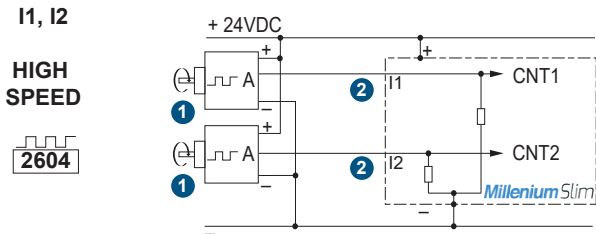

- 1 Encoder
- 2 High-Speed Input

I1, I2: Inputs I1 and I2

Wiring Diagram

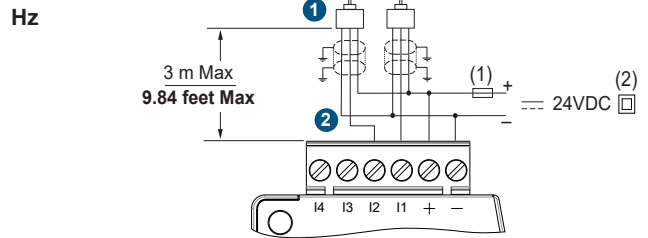

- (1) 1A (UL248) quick blowing fuse, circuit breaker, or circuit protector (US)
- (2) Isolating source

Inputs
PWM Inputs

Millenium Slim - Type CB8R DC - 88983901 → Inputs I3 and I4
 Millenium Slim - Type CB8S DC - 88983902 → Inputs I3 and I4

Electronic Diagram

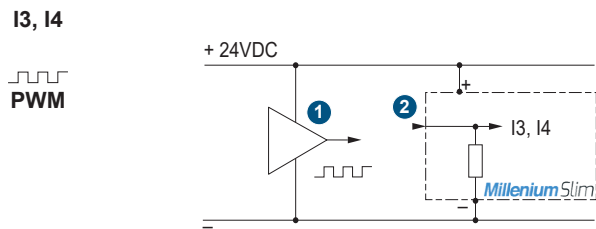

- 1 PWM Source
- 2 PWM Inputs

I3, I4: Inputs I3 and I4

Wiring Diagram

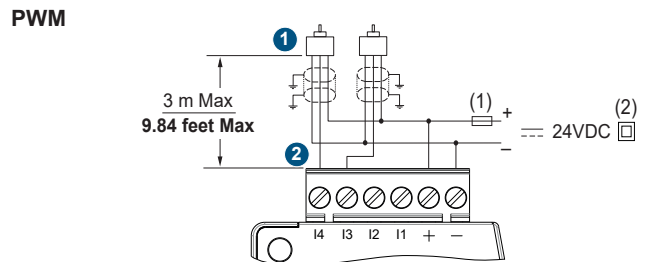

- (1) 1A (UL248) quick blowing fuse, circuit breaker, or circuit protector (US)
- (2) Isolating source

Inputs

Analog Inputs

Millenium Slim - Type CB8R DC - 88983901 → Inputs I1, I2, I3 and I4

Millenium Slim - Type CB8S DC - 88983902 → Inputs I1, I2, I3 and I4

Electronic Diagram

I1 ... I4 U

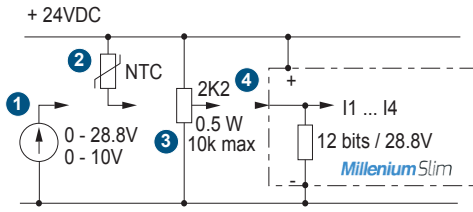

Wiring Diagram

28.8 V, NTC, R

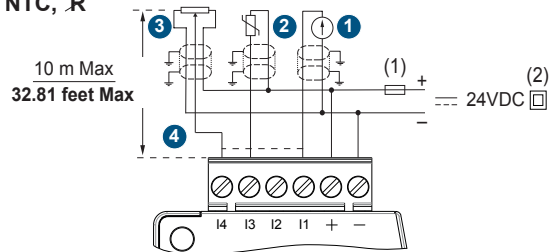

- 1 0-10 V
- 2 NTC Probe
- 3 Potentiometer
- 4 Analog Input

- (1) 1A (UL248) quick blowing fuse, circuit breaker, or circuit protector (US)
- (2) Isolating source

I1... I4: Inputs I1, I2, I3 and I4

Outputs

Relay Outputs

Millenium Slim - Type CB8R AC - 88983903 → Outputs O1, O2, O3 and O4

Millenium Slim - Type CB8R DC - 88983901 → Outputs O1, O2, O3 and O4

Electronic Diagram

O1 ... O4

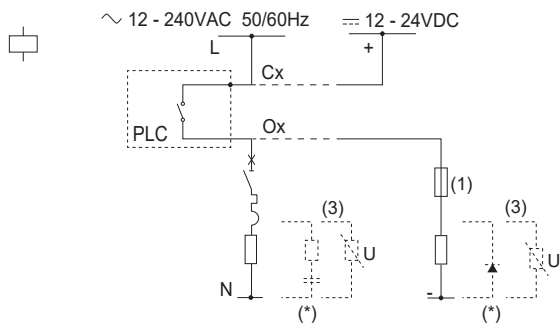

Wiring Diagram

6 A

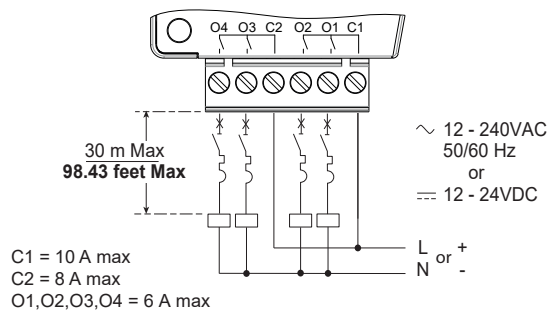

- C1 = 10 A max
- C2 = 8 A max
- O1, O2, O3, O4 = 6 A max

(*) Protection
*PLC: Millenium Slim Logic Controller

Common limits currents
O1+O2= 10A max @25C (8A @40C, 4A @55C, 2.6 @ 60C)
O3+O4=8A max @25C (8A @40C, 4A @ 55C, 2.6 @ 60C)

Outputs

Static / PWM Outputs

Millenium Slim - Type CB8S DC - 88983902 → Outputs O1, O2, O3 and O4

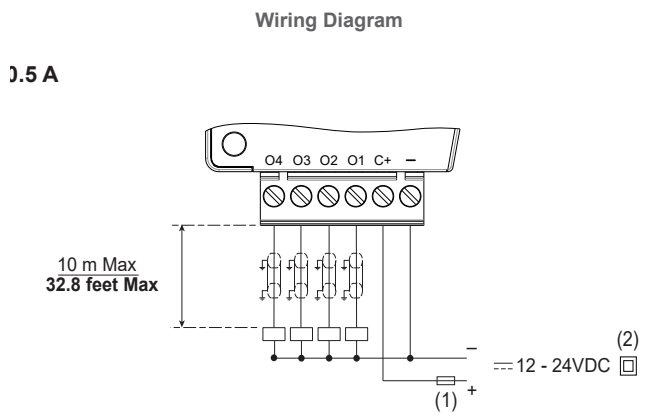
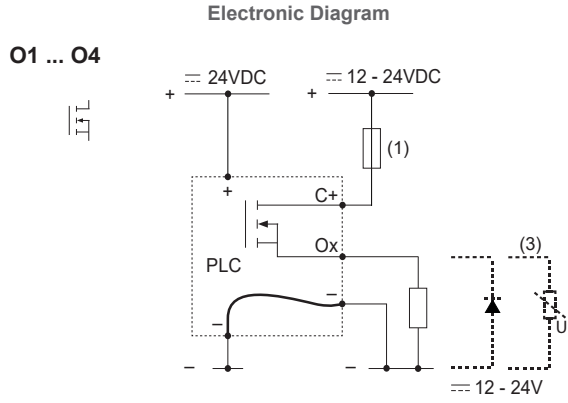

(3) Inductive load
*PLC: Millenium Slim Logic Controller

(1) 1A (UL248) quick-blowing fuse, circuit-breaker, or circuit protector (US)
(2) Isolating source

Accessories

BLUETOOTH DONGLE



Description	Part Number
USB Dongle Bluetooth, CE, FCC and IC certified	88980124

SIGNAL CONVERTER



Description	Part Number
0-20 mA to 0-10 V	88950108

TEMPERATURE PROBES



Description	Part Number
NTC2, PVC probe	89750174



NTC1, TPE probe	89750180
-----------------	-----------------



NTC2, INOX probe	89750182
------------------	-----------------



NTC2, POM probe	89750185
-----------------	-----------------



NTC3, SILICONE probe	89750186
----------------------	-----------------

TEMPERATURE CONVERTERS



Description	Part Number
Pt1000 3-wire	88950150
Pt100 3-wire (-40 → +40°C)	88950151
Pt100 3-wire (0 → +100°C)	88950152
Pt100 3-wire (0 → +250°C)	88950153
Thermocouple J	88950154
Thermocouple K	88950155

POWER SUPPLIES



Description	Part Number
Modular of 10W	89451001



Modular of 30W	89451003
----------------	-----------------



Modular of 60W	89451006
----------------	-----------------



Modular of 100W	89451010
-----------------	-----------------

TEMPERATURE SENSORS



Description	Part Number
Air Sensor	89750190



Duct Probe	89750191
------------	-----------------



External Probe	89750192
----------------	-----------------



Remote/Submersible	89750193
--------------------	-----------------

Warning:

The product information contained in this catalogue is given purely as information and does not constitute a representation, warranty or any form of contractual commitment. Crouzet and its subsidiaries reserve the right to modify their products without notice. It is imperative that we should be consulted over any particular use or application of our products and it is the responsibility of the buyer to establish, particularly through all the appropriate tests, that the product is suitable for the use or application. Under no circumstances will our warranty apply, nor shall we be held responsible for any application (such as any modification, addition, deletion, use in conjunction with other electrical or electronic components, circuits or assemblies, or any other unsuitable material or substance) which has not been expressly agreed by us prior to the sale of our products.

X-ON Electronics

Largest Supplier of Electrical and Electronic Components

Click to view similar products for [Controllers](#) category:

Click to view products by [Crouzet](#) manufacturer:

Other Similar products are found below :

[61FGPN8DAC120](#) [CV500SLK21](#) [70177-1011](#) [F03-03 HAS C](#) [F03-31](#) [81550401](#) [FT1A-C12RA-W](#) [H2CAC24A](#) [H2CRSAC110B](#) [R88A-CRGB003CR-E](#) [R88ARR080100S](#) [R88A-TK01K](#) [DCN1-1](#) [AFP0RT32CT](#) [DRT2ID08C](#) [DTB4896VRE](#) [DTB9696CVE](#) [DTB9696LVE](#) [E53-AZ01](#) [E53E01](#) [E53E8C](#) [E5C4Q40J999FAC120](#) [E5CWLQ1TCAC100240](#) [E5GNQ03PFLKACDC24](#) [B300LKL21](#) [NSCXDC1V3](#) [NSH5-232CW-3M](#) [NT20SST122BV1](#) [NV-CN001](#) [OAS-160-N](#) [C40PEDRA](#) [K31S6](#) [K33-L1B](#) [K3MA-F 100-240VAC](#) [K3TX-AD31A](#) [89750101](#) [L595020](#) [SRM1-C02](#) [SRS2-1](#) [G32X-V2K](#) [26546803](#) [26546805](#) [PWRA440A](#) [CPM1AETL03CH](#) [CV500SLK11](#) [3G2A5BI081](#) [3G2A5IA122](#) [3G2A5LK010E](#) [3G2A5OA223](#) [3G2A5OD211](#)