

BRUSH MOTORS

The power of silence



MEDICAL
DESIGN BRIEFS
2013 Product of the Year



ABOUT CROUZET

The Motion product line provides innovative engineering expertise, high quality service and a complete offer of standard direct drives, geared motors and motion control solutions for applications where performance is key. Our ability to customize solutions as per virtually any customers' request makes us the right partner to tackle the most demanding projects.

Crouzet is a brand of InnoVista Sensors™.

With a long-term commitment to technological excellence, the engineering teams have mastered the following core technologies and know-how:

- › Electromagnetism
- › Thermal dynamics
- › Electromechanical systems
- › Electronic drives

Covering the power range from 1 to 1000 W peak (1/100 to 1HP+) and available with spur, worm or planetary gearboxes, plus adapted controllers, our offer is specifically designed for access control systems, pumps and valves, railway applications, electrical equipment, medical equipment and the industry.

INNOVISTA SENSORS

InnoVista Sensors™ is a worldwide industrial specialist of sensors, controllers and actuators for automated systems.

Through its brands, Crouzet and Systron Donner Inertial, InnoVista Sensors™ offers a wide range of reliable, efficient and customizable components dedicated to the Aerospace & Defense, Transportation and Industrial markets and segments.

Thanks to the recognized expertise of its teams and a strong innovation policy, InnoVista Sensors™ brings performance enhancing solutions to its customers worldwide.

InnoVista Sensors™: your trusted partner of choice to face industrial challenges of today and tomorrow.

www.innovistasensors.com

Designs & Manufactures



Sensors



Controls

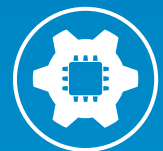

Actuators

For



Aerospace
& Defense



Transportation



Industry

ADAPTATION WHEEL

To meet market expectations and provide customers with the right solutions within the shortest timeframes, Crouzet has structured its processes around the different types of product available: standard products, adapted products or products specially developed for a customer.
Introducing the adaptation wheel...

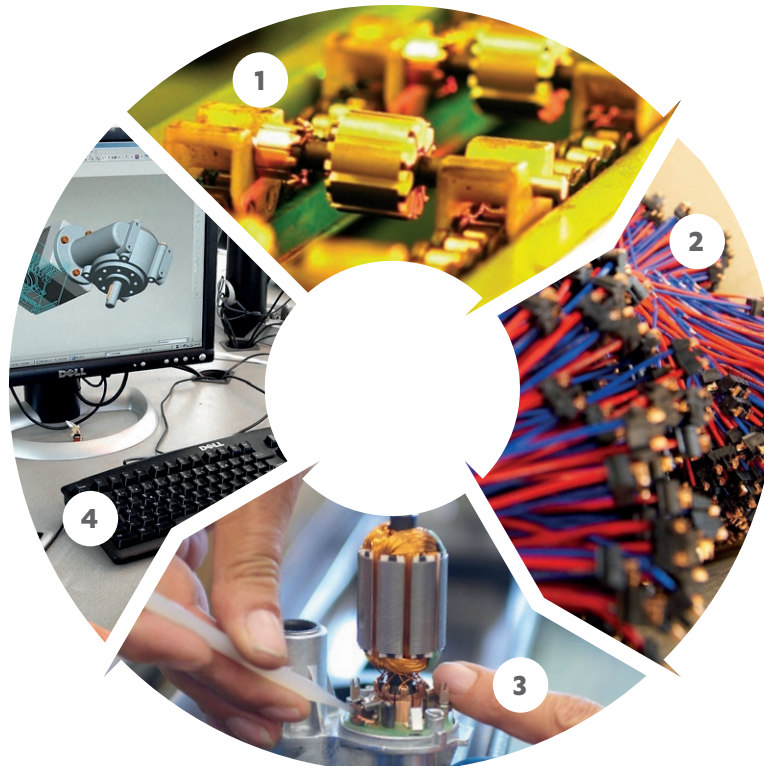

1 STANDARD PRODUCTS

Sales service

A full range of motors, geared motors and associated controllers. You can create your automation control applications as quickly as possible

2 PRODUCTS WITH ADDED VALUE

Customer Adaptation Centre

All our standard products can have additional factory-mounted auxiliaries or accessories: connectors, leads, special terminals, customized shafts, adaptor plates, etc. Seamless integration in your equipment means you benefit from simpler logistics and optimum installation reliability.

3 ADAPTED PRODUCTS

Customer Adaptation Centre

Defined in coordination between your project teams and our specialists, these adapted products have exactly the right levels of performance and functionality you need for your applications.

4 SPECIAL PRODUCTS

Engineers and teams Dedicated project

From the very start of a project, Crouzet' experts work closely with your teams to develop the specification. All our design, industrialization and approval expertise goes into developing Motion Control solutions that are tailored to your requirements.

DCmind BRUSH

THE QUIETEST ON THE MARKET

With more than 50 years' experience, Crouzet, a specialist in customized Motion Solutions, presents its DCmind Brush range of direct current Brush motors.

Designed by the engineers in Crouzet, this range - the quietest on the market - is ideally suited to the medical, industrial and commercial equipment sectors.

PRODUCT BENEFITS:

- › Exceptionally quiet: 35 dBA
- › Service life up to 24,000 hours
- › More than 80% efficiency
- › Output power up to 104 W
- › 12, 24, 48, 90 and 120 V_{DC} power supplies and other voltages on request
- › Up to IP69K
- › Conformity to the specific standards for your market and required approvals

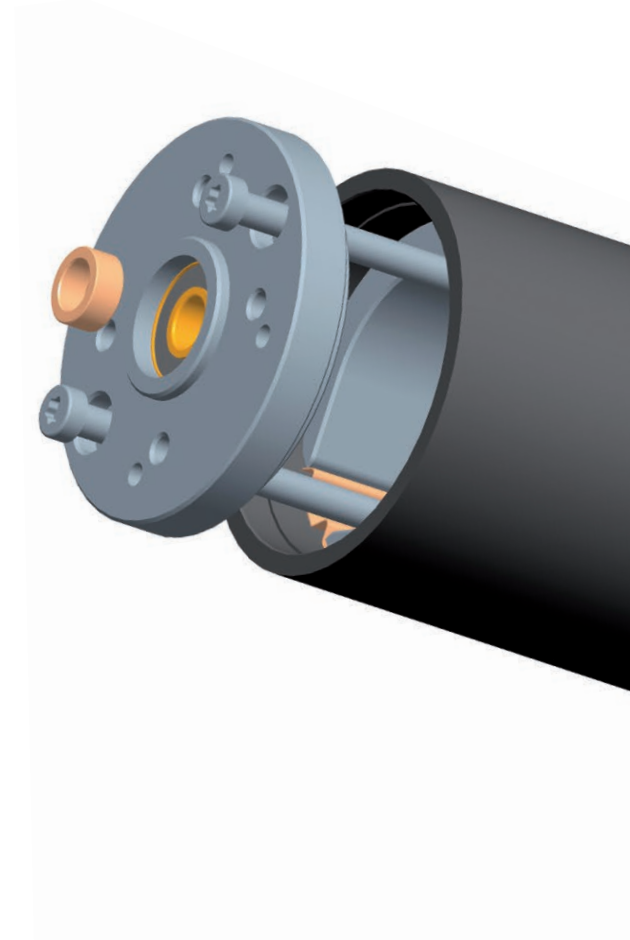

EXCEPTIONALLY QUIET

Systematic approach to eliminate noise

- › At source
- › From transmission
- › From dispersion

Innovative design

- › Choice of new materials
- › Optimization of component assembly (centering, perpendicularity, parallelism, etc.)

A range of gearbox

- › In line with high performance motor

SERVICE LIFE UP TO 24,000 HOURS

- › Its average service life, in continuous duty, is between 24,000 hours at no-load and 5000 hours at rated load

MORE THAN 80% EFFICIENCY

High performance magnetic circuit

- › Optimum magnetic flux
- › Magnets designed to optimize the detent torque

Optimal electromagnetic performance

- › Energy losses on the winding
- › Magnetic losses
- › Minimal friction

DCmind BRUSH: ECO-DESIGN

Crouzet has been involved in eco-design for many years (ISO 14001 held since 1997).

Its production plants have some of the lowest existing impacts on the environment, and in addition, all Crouzet's product developments are constantly reducing their footprint on ecosystems.

The DCmind Brush motors range reduces this footprint to a third of more conventional manufacturing techniques.

ECOLOGICAL FOOTPRINT ON NATURAL ENVIRONMENTS:

Throughout a product's service life, from design through to the recycling stage, every manufactured product has an impact on ecosystems.

Reducing this footprint is a priority for any company that cares about the environment.

The diagram opposite compares the footprint of a conventional design with the new design.

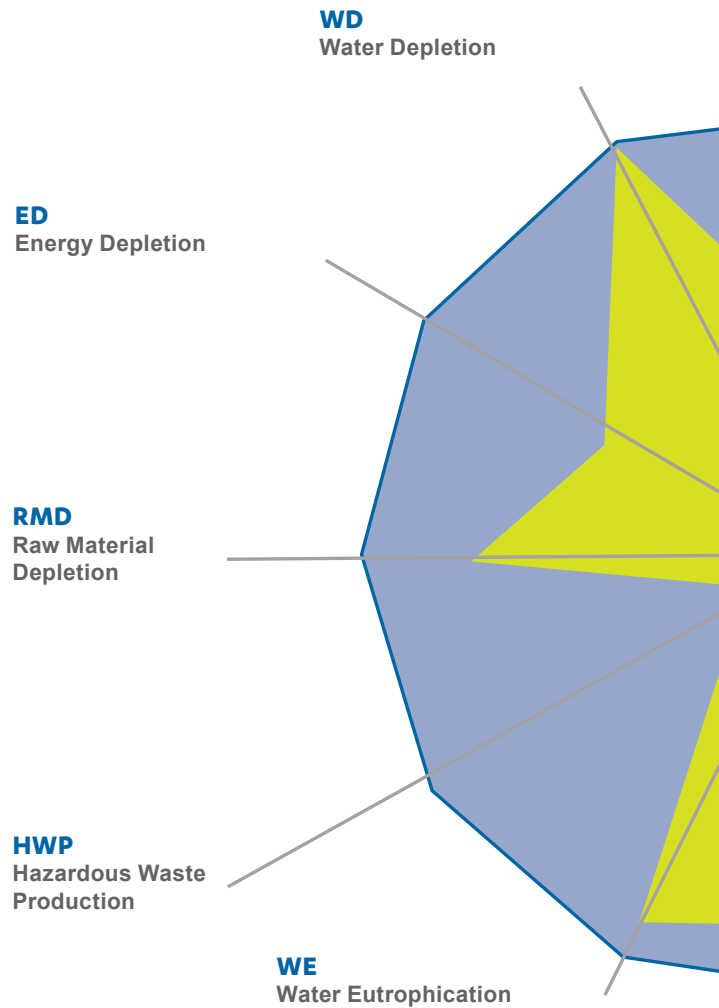





■ Footprint usually left on ecological environments by standard industrial design motors.

DCmind BRUSH: SELECTION GUIDE

To complement the current range from Crouzet, the latest generation of DC Brush direct drive and geared motors have been precision engineered to minimise all mechanical and electro-mechanical variations.

Extremely quiet, this range is ideally suited to medical and laboratory applications.



					TYPE OF GEARBOX			
					OUTPUT POWER (W)	NOMINAL TORQUE (mNm)	NOMINAL SPEED (rpm)	FAMILY
					MAX. TORQUE (Nm)			
DIRECT DRIVE MOTORS								
Ø 42 mm								
89810		15	50	2920				
89800		24	75	3100				
89850		35	110	3000				
Ø 63 mm								
89830		57	180	3000				
89890		104	290	3430				

Motors 24 V_{DC}

ACCESSORIES AND ADAPTATIONS

- › Rear Friction Brake
- › 1,000 Pulse 2-Channel Encoder
- › Connectors
- › Voltage, speed, power
- › Shaft dimensions and material
- › Motor length
- › Other ratios and gearboxes
- › Etc.

DCmind: DC DIRECT-DRIVE BRUSH MOTORS

Ø 42 mm - 20 W

- › Silent motor
- › 12 V and 24 V built in EMC filter class B
- › Excellent efficiency
- › Long life
- › IP65
- › In accordance with UL - CE - ROHS regulations



Part numbers

	12 V	24 V	48 V
Type	89810	89810	89810
Voltage	12 V ⁻⁻⁻	24 V ⁻⁻⁻	48 V ⁻⁻⁻
References			
Option: IP65 level	89810007	89810008	89810003
Option: holding brake 0.25 Nm, 24 V ⁻⁻⁻	89810507	89810508	89810503
Option: 2 channels encoder 1000 pulses/revolution, 5 V ⁻⁻⁻	89810907	89810908	89810903
No-load characteristics			
Speed (rpm)	4200	4000	4100
Absorbed current (A)	0.26	0.11	0.07
Nominal characteristics			
Speed (rpm)	2900	2920	2980
Torque (mNm)	50	50	50
Output power (W)	15	15	16
Absorbed current (A)	2.1	1	0.53
Efficiency (%)	60	64	61
Maximum efficiency characteristics			
Speed (rpm)	3500	3300	3400
Torque (mNm)	27	30	31
Output power (W)	10	10	11
Absorbed current (A)	1.26	0.6	0.35
Efficiency (%)	65	72	65
General characteristics			
Insulation conforming to IEC60085	Class E	Class E	Class E
Noise level (dBA)	35	35	35
Max. output power (W)	17	20	19
Starting torque (mNm)	158	190	180
Starting current (A)	6.1	3.3	1.7
Resistance (Ω)	2	7.3	28
Inductance (mH)	1.3	6	22
Torque constant (mNm/A)	27	56	109
Electrical time constant (ms)	0.7	0.8	0.8
Mechanical time constant (ms)	20	17	18
Inertia (g.cm ²)	75	75	75
Weight (g)	340	340	340
Commutator segments	8	8	8
Service life (h)	4000	4000	4000
Wires length (mm)	200	200	200
Ball bearing	✓	✓	✓
Comments			
IP65 level except for the output shaft. Encoder and brake options are IP20.			

Product adaptations, contact us



- › Special output shaft
- › Shaft with pinion, pulley, worm gear
- › Special supply voltage
- › Other wire length
- › Optical or Hall effect encoder - 1 or 2 channels
- › Specific motor mounting flange
- › Special motor connectors
- › IP67, IP69K

Product made to order

DCmind: DC DIRECT-DRIVE BRUSH MOTORS

Ø 42 mm - 36 W

- › Silent motor
- › 12 V and 24 V built in EMC filter class B
- › Excellent efficiency
- › Long life
- › IP65
- › In accordance with UL - CE - ROHS regulations



Part numbers

	12 V	24 V	48 V
Type	89800	89800	89800
Voltage	12 V ^{DC}	24 V ^{DC}	48 V ^{DC}
References			
Option: IP65 level	89800007	89800008	89800003
Option: holding brake 0.25 Nm, 24 V ^{DC}	89800507	89800508	89800503
Option: 2 channels encoder 1000 pulses/revolution, 5 V ^{DC}	89800907	89800908	89800903
No-load characteristics			
Speed (rpm)	4200	4000	3930
Absorbed current (A)	0.26	0.115	0.07
Nominal characteristics			
Speed (rpm)	3050	3100	3150
Torque (mNm)	75	75	75
Output power (W)	24	24	25
Absorbed current (A)	3	1.43	0.72
Efficiency (%)	67	71	72
Maximum efficiency characteristics			
Speed (rpm)	3620	3500	3450
Torque (mNm)	38	41	48
Output power (W)	14	15	17
Absorbed current (A)	1.6	0.84	0.49
Efficiency (%)	73	75	74
General characteristics			
Insulation conforming to IEC60085	Class E	Class E	Class E
Noise level (dBA)	35	35	35
Max. output power (W)	30	36	39
Starting torque (mNm)	276	344	377
Starting current (A)	10.3	6.1	3.3
Resistance (Ω)	1.2	3.9	14.5
Inductance (mH)	0.8	3	13
Torque constant (mNm/A)	27	57	115
Electrical time constant (ms)	0.7	0.8	0.9
Mechanical time constant (ms)	17	13	12
Inertia (g.cm ²)	110	110	110
Weight (g)	450	450	450
Commutator segments	8	8	8
Service life (h)	4000	4000	4000
Wires length (mm)	200	200	200
Ball bearing	✓	✓	✓
Comments			
IP65 level except for the output shaft. Encoder and brake options are IP20.			

Product adaptations, contact us



- › Special output shaft
- › Shaft with pinion, pulley, worm gear
- › Special supply voltage
- › Other wire length
- › Optical or Hall effect encoder - 1 or 2 channels
- › Specific motor mounting flange
- › Special motor connectors
- › IP67, IP69K

Product made to order

DCmind: DC DIRECT-DRIVE BRUSH MOTORS

Ø 42 mm - 51 W

- › Silent motor
- › 12 V and 24 V built in EMC filter class B
- › Excellent efficiency
- › Long life
- › IP65
- › In accordance with UL - CE - ROHS regulations



Part numbers

	12 V	24 V	48 V
Type	89850	89850	89850
Voltage	12 V ^{DC}	24 V ^{DC}	48 V ^{DC}
References			
Option: IP65 level	89850007	89850008	89850003
Option: holding brake 0.25 Nm, 24 V ^{DC}	89850507	89850508	89850503
Option: 2 channels encoder 1000 pulses/revolution, 5 V ^{DC}	89850907	89850908	89850903
No-load characteristics			
Speed (rpm)	4000	3750	3840
Absorbed current (A)	0.31	0.14	0.08
Nominal characteristics			
Speed (rpm)	3000	3000	3000
Torque (mNm)	110	110	110
Output power (W)	35	35	35
Absorbed current (A)	4.1	1.9	1
Efficiency (%)	70	76	72
Maximum efficiency characteristics			
Speed (rpm)	3500	3320	3400
Torque (mNm)	52	60	60
Output power (W)	19	21	21
Absorbed current (A)	2.1	1.1	0.58
Efficiency (%)	76	80	77
General characteristics			
Insulation conforming to IEC60085	Class E	Class E	Class E
Noise level (dBA)	35	35	35
Max. output power (W)	44	51	50
Starting torque (mNm)	420	520	500
Starting current (A)	15	8.4	4.2
Resistance (Ω)	0.8	2.9	11.4
Inductance (mH)	0.5	2	8
Torque constant (mNm/A)	29	63	120
Electrical time constant (ms)	0.6	0.7	0.7
Mechanical time constant (ms)	15	12	13
Inertia (g.cm ²)	160	160	160
Weight (g)	620	620	620
Commutator segments	8	8	8
Service life (h)	4000	4000	4000
Wires length (mm)	200	200	200
Ball bearing	✓	✓	✓
Comments			
IP65 level except for the output shaft. Encoder and brake options are IP20.			

Product adaptations, contact us



- › Special output shaft
- › Shaft with pinion, pulley, worm gear
- › Special supply voltage
- › Other wire length
- › Optical or Hall effect encoder - 1 or 2 channels
- › Specific motor mounting flange
- › Special motor connectors
- › IP67, IP69K

Product made to order

DCmind: DC DIRECT-DRIVE BRUSH MOTORS

Ø 63 mm - 102 W

- › Silent motor
- › 12 V and 24 V built in EMC filter class B
- › Excellent efficiency
- › Long life
- › IP65
- › In accordance with UL - CE - ROHS regulations



Part numbers

	12 V	24 V	48 V	90 V
Type	89830	89830	89830	89830
Voltage	12 V ^{DC}	24 V ^{DC}	48 V ^{DC}	90 V ^{DC}
References				
Option: IP65 level	89830011	89830012	89830003	89830004
Option: holding brake 0.5 Nm, 24 V ^{DC}	89830511	89830512	89830503	89830504
Option: 2 channels encoder 1000 pulses/revolution, 5 V ^{DC}	89830911	89830912	89830903	89830904
No-load characteristics				
Speed (rpm)	3830	3600	3550	3550
Absorbed current (A)	0.52	0.23	0.14	0.07
Nominal characteristics				
Speed (rpm)	2850	3000	3050	3000
Torque (mNm)	180	180	180	180
Output power (W)	54	57	57	57
Absorbed current (A)	6.5	3.1	1.54	0.83
Efficiency (%)	69	77	78	76
Maximum efficiency characteristics				
Speed (rpm)	3340	3240	3200	3200
Torque (mNm)	90	111	131	128
Output power (W)	31	38	44	43
Absorbed current (A)	3.5	1.97	1.15	0.61
Efficiency (%)	75	80	80	78
General characteristics				
Insulation conforming to IEC 60085	Class E	Class E	Class E	Class E
Noise level (dBA)	35	35	35	35
Max. output power (W)	70	102	114	109
Starting torque (mNm)	703	1080	1230	1177
Starting current (A)	24	17.2	9.7	5
Resistance (Ω)	0.5	1.4	4.9	18
Inductance (mH)	0.38	1.7	7	25
Torque constant (mNm/A)	30	64	129	237
Electrical time constant (ms)	0.8	1.2	1.4	1.4
Mechanical time constant (ms)	21	13	11	12
Inertia (g.cm ²)	380	380	380	380
Weight (g)	1200	1200	1200	1200
Commutator segments	12	12	12	12
Service life (h)	5000	5000	5000	5000
Wires length (mm)	200	200	200	200
Ball bearing	✓	✓	✓	✓
Comments				
IP65 level except for the output shaft. Encoder and brake options are IP20.				

Product adaptations, contact us



- › Special output shaft
- › Shaft with pinion, pulley, worm gear
- › Special supply voltage
- › Other wire length
- › Optical or Hall effect encoder - 1 or 2 channels
- › Specific motor mounting flange
- › Special motor connectors
- › IP67, IP69K

Product made to order

DCmind: DC DIRECT-DRIVE BRUSH MOTORS

Ø 63 mm - 209 W

- › Silent motor
- › 24 V built in EMC filter class B
- › Excellent efficiency
- › Long life
- › IP65
- › In accordance with UL - CE - ROHS regulations



Part numbers

	24 V	48 V	90 V	120 V
Type	89890	89890	89890	89890
Voltage	24 V ⁻⁻⁻	48 V ⁻⁻⁻	90 V ⁻⁻⁻	120 V ⁻⁻⁻
References				
Option: IP65 level	89890011	89890003	89890004	89890005
Option: holding brake 0.5 Nm, 24 V ⁻⁻⁻	89890511	89890503	89890504	89890505
Option: 2 channels encoder 1000 pulses/revolution, 5 V ⁻⁻⁻	89890911	89890903	89890904	89890905
No-load characteristics				
Speed (rpm)	4000	3780	3700	3730
Absorbed current (A)	0.34	0.16	0.09	0.07
Nominal characteristics				
Speed (rpm)	3430	3370	3320	3350
Torque (mNm)	290	290	290	290
Output power (W)	104	102	101	102
Absorbed current (A)	5.4	2.53	1.34	1.01
Efficiency (%)	80	84	84	84
Maximum efficiency characteristics				
Speed (rpm)	3660	3480	3410	3430
Torque (mNm)	179	207	218	230
Output power (W)	69	75	78	83
Absorbed current (A)	3.5	1.9	1	0.82
Efficiency (%)	82	84	84	84
General characteristics				
Insulation conforming to IEC60085	Class E	Class E	Class E	Class E
Noise level (dBA)	35	35	35	35
Max. output power (W)	209	265	269	281
Starting torque (mNm)	2000	2680	2780	2875
Starting current (A)	35.3	22.2	12.1	9.4
Resistance (Ω)	0.7	2.2	7.4	12.8
Inductance (mH)	0.73	3.3	12	21
Torque constant (mNm/A)	57	122	232	308
Electrical time constant (ms)	1.1	1.5	1.6	1.6
Mechanical time constant (ms)	13	9	9	9
Inertia (g.cm ²)	650	650	650	650
Weight (g)	1600	1600	1600	1600
Commutator segments	12	12	12	12
Service life (h)	5000	5000	5000	5000
Wires length (mm)	200	200	200	200
Ball bearing	✓	✓	✓	✓
Comments				
IP65 level except for the output shaft. Encoder and brake options are IP20.				

Product adaptations, contact us



- › Special output shaft
- › Shaft with pinion, pulley, worm gear
- › Special supply voltage
- › Other wire length
- › Optical or Hall effect encoder - 1 or 2 channels
- › Specific motor mounting flange
- › Special motor connectors
- › IP67, IP69K

Product made to order

GEARBOXES FOR DCmind BRUSH RANGE

3 to 25 Nm

- › Planetary and worm gearboxes, very silent versions
- › Shafts on ball bearings
- › Long service life

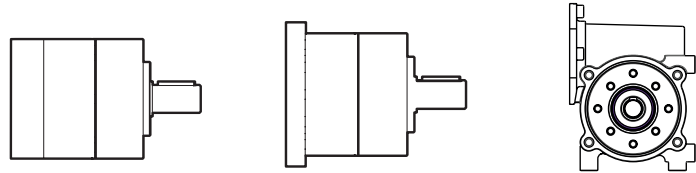

Part numbers

Gearboxes									
Family	A1			B1			RAD10		
Type of gearbox	Planetary \varnothing 42			Planetary \varnothing 52			Worm gear		
Associated motors	Gear motor reference			Gear motor reference			Gear motor reference		
89810 IP65 / Holding brake / Encoder	8981 A1 / A5 / A9								
89800 IP65 / Holding brake / Encoder	8980 A1 / A5 / A9								
89850 IP65 / Holding brake / Encoder	8985 A1 / A5 / A9								
89830 IP65 / Holding brake / Encoder				8983 B1 / B5 / B9			8983 10 / 15 / 19		
89890 IP65 / Holding brake / Encoder				8989 B1 / B5 / B9			8989 10 / 15 / 19		
General characteristics									
Number of stages	1	2	3	1	2	3	1		
Maximum permitted torque (Nm)	3	7.5	15	4	12	25	10		
Efficiency	0.8	0.75	0.7	0.8	0.75	0.7	0.6	→ 0.3	
Axial dynamic load (daN)	5	8	11	6	10	15	10		
Radial dynamic load (daN)	16	23	30	20	32	45	15		
Weight (kg)	0.3	0.4	0.5	0.7	0.9	1.1	0.6		
Standard reduction ratios	9	45	302	7-9	28-45	302	5 - 10 - 20 - 30 - 50		
Other ratios possible	58 - 137 - 232 - 393			58 - 137 - 192 - 232 - 393			15 - 100		
Operating temperature	-30 → +70°C			-30 → +70°C			-10 → +75°C		
Typical noise level	45 dBA			45 dBA			45 dBA		
Comments									

Planetary gearboxes:

To maintain a very low noise level, the motor pinion is precision machined on motor shaft to obtain optimum concentricity and parallelism. The gears in the first stage are helical-cut and made from a composite material. This design significantly improves gear life by reducing wear due to friction, increases gearbox efficiency and ensures a very low noise level even with the gearbox under load.

Worm gearbox:

This gearbox combines a tempered steel worm gear with a hardened bronze helical wheel, a combination that ensures a long service life. The helical wheel rotates in a grease reservoir to provide an excellent slip coefficient and dissipate heat. O-rings and lip seals equipped with garter springs are used to ensure sealing the gearbox output shaft.

The gearbox casing is made of aluminium to maximize heat dissipation.

However, because of the high power rating of this gearbox and the lower efficiency inherent in ratio worm gearboxes, care must be taken not to exceed a temperature of 75°C on the gearbox casing during operation.

The output shaft configuration can be right, left, or a dual shaft (shaft output on both sides).

Product adaptations, contact us



- › Special shafts
- › Other reduction ratios
- › Other fixing holes
- › Special mounting flange

DCmind: DC BRUSH GEARMOTORS

Dimensions (mm)

8981A1 - 8980A1 - 8985A1

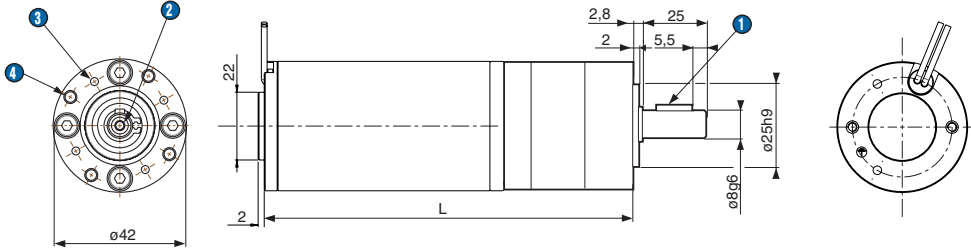

8981A1
 L 1 stage: 119.9 max.
 L 2 stages: 133 max.
 L 3 stages: 146.1 max.

8980A1
 L 1 stage: 135 max.
 L 2 stages: 148.1 max.
 L 3 stages: 161.2 max.

8985A1
 L 1 stage: 161.1 max.
 L 2 stages: 174.2 max.
 L 3 stages: 187.3 max.

- 1 Parallel key 3 x 3 x 16 DIN6885
- 2 M3, depth 9
- 3 4 x M3 at 90°, depth 7 over Ø 32
- 4 4 x M4 at 90°, depth 10 over Ø 36

8983B1 - 8989B1

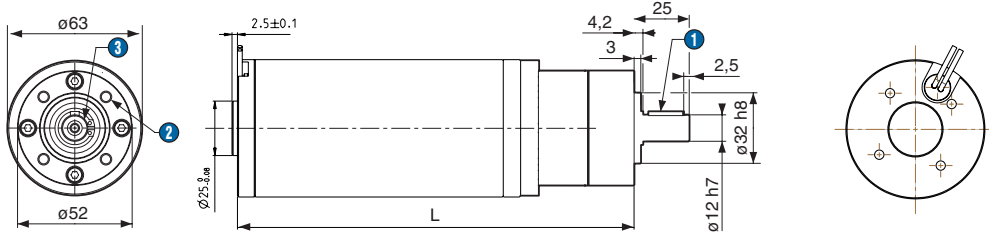

8983B1
 L 1 stage: 159.1 max.
 L 2 stages: 173.3 max.
 L 3 stages: 187.5 max.

8989B1
 L 1 stage: 183.6 max.
 L 2 stages: 197.8 max.
 L 3 stages: 212 max.

- 1 Parallel key 4 x 4 x 16 DIN6885
- 2 4 x M5 at 90°, depth 10 over Ø 40
- 3 M4, depth 10

898310 - 898910 (left side shaft output)

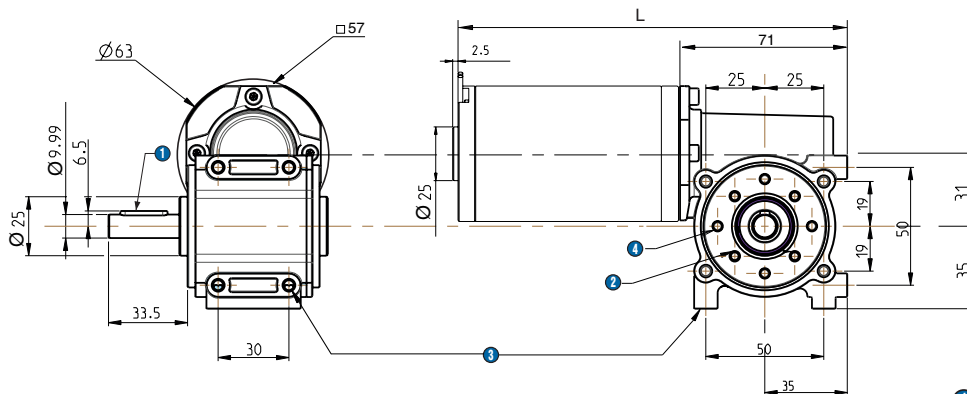

898310
 L: 174.2 max.

898910
 L: 198.7 max.

- 1 Parallel key 4 x 4 x 20 DIN6885
- 2 4 x M4, depth 8 over Ø 36
- 3 8 x M5, depth 8
- 4 4 x 3.8, depth 10 over Ø 40

AMERICAS**CANADA**

Tel.: +1 (855) 929-5465
americas.custserv@crouzet.com

MEXICO

Tel.: +1 (855) 929-5465
americas.custserv@crouzet.com

USA

+1 (855) 929-5465
americas.custserv@crouzet.com

COUNTRIES NOT LISTED

+1 (855) 929-5465
americas.custserv@crouzet.com

EUROPE / MIDDLE EAST / AFRICA**BELGIUM**

Tel.: +32 (0) 2 620 06 05
Fax: +32 (0) 2 461 00 23
klantenservice@crouzet.com

FRANCE

Tel.: +33 (0) 475 802 101
Fax: +33 (0) 475 828 900
relationclient@crouzet.com

GERMANY / AUSTRIA

Tel.: +49 (0) 2103/9385930
Fax: +49 (0) 2103/980-222
kundenservice@crouzet.com

ITALY

Tel.: +39 (02) 38 594 099
Fax: +39 (02) 82 952 104
assistenzaclienti@crouzet.com

SPAIN / PORTUGAL

Tel.: +34 (91) 215 80 95
Fax: +34 (93) 2 20 02 05
atencionalcliente@crouzet.com

SWITZERLAND

Tel.: +41 (0) 225 67 57 90
Fax: +41 (0) 565 88 02 75
kundenservice@crouzet.com

THE NETHERLANDS

Tel.: +31 (0) 20-654 52 20
klantenservice@crouzet.com

UNITED KINGDOM

Tel.: +44 (0) 2076 600 025
customer.relation@crouzet.com

COUNTRIES NOT LISTED

Tel.: +33 (0) 475 802 102
Fax: +33 (0) 475 828 900
customer.relation@crouzet.com

ASIA / PACIFIC**CHINA**

Tel.: +86 (21) 8025 7166
Fax: +86 (21) 6107 1771
china@crouzet.com

INDIA

Tel.: +91 (80) 4113 2204/05
Fax: +91 (80) 4113 2206
india@crouzet.com

SOUTH KOREA

Tel.: +82 (2) 2679 8312
Fax: +82 (2) 2679 9888
korea@crouzet.com

EAST ASIA PACIFIC

Tel.: +86 (21) 8025 7177
Fax: +86 (21) 6107 1771
eap@crouzet.com

Warning:

The product information contained in this catalogue is given purely as information and does not constitute a representation, warranty or any form of contractual commitment. Crouzet Automatismes SAS and its subsidiaries reserve the right to modify their products without notice. It is imperative that we should be consulted over any particular use or application of our products and it is the responsibility of the buyer to establish, particularly through all the appropriate tests, that the product is suitable for the use or application. Under no circumstances will our warranty apply, nor shall we be held responsible for any application (such as any modification, addition, deletion, use in conjunction with other electrical or electronic components, circuits or assemblies, or any other unsuitable material or substance) which has not been expressly agreed by us prior to the sale of our products.

X-ON Electronics

Largest Supplier of Electrical and Electronic Components

Click to view similar products for [AC, DC & Servo Motors](#) category:

Click to view products by [Crouzet](#) manufacturer:

Other Similar products are found below :

[805470B40040MY](#) [R88M-G10030H-S2](#) [R88MK15K015CS2](#) [R88MK1K520HS2](#) [R88MK3K030FBS2](#) [R88MK1K530HBS2](#)
[R88MK75030TS2](#) [1032](#) [M4E068-CF01-01](#) [80510503](#) [805470A403.6MY](#) [805470B40020MY](#) [80627003](#) [82800003](#) [82830009](#)
[R88MK2K030FS2](#) [KDE4014XF-380 \(D5\)](#) [R88A-RG08UA](#) [82810017](#) [82861019](#) [89850008](#) [R88M-K75030H](#) [R88M-G10030L-OS2](#) [R88M-](#)
[GP20030L-OS2](#) [R88M-K90010F-S2](#) [R88M-GP40030L-OS2](#) [R88M-K1K030H-S2](#) [R88M-GP20030H-BO](#) [R88M-G10030L-BO](#) [R88M-](#)
[GP20030S-OS2](#) [R88M-K20030H-B](#) [R88M-G40030H-BS2](#) [R88M-GP20030H-O](#) [R88M-G40030T-S2](#) [R88M-K10030L](#) [82840003](#) [82840004](#)
[R88M-GP20030L](#) [R88M-GP20030H-BS2](#) [R88M-GP10030S](#) [R88M-GP20030L-S2](#) [R88M-G40030H](#) [R88M-GP20030L-O](#) [R88M-GP20030L-](#)
[BS2](#) [R88M-GP20030T-OS2](#) [82869011](#) [89850007](#) [R88M-K1K020F](#) [82524021](#) [R88M-K1K520F](#)