

Counters and Ratemeters

Counting accuracy

Presentation



Crouzet Control

Expert in the design of efficient and innovative monitoring & control products, Crouzet Control, supported by an experienced worldwide team, offers a broad range of industry standard and application specific adapted products in timing, control relays and counting functions.

Crouzet Control is a brand of InnoVista Sensors™.

With operations around the globe, Crouzet Control is constantly monitoring its customers' needs. Its sales teams, technicians and designers combine all their skills to adapt products to customer specifications, both in terms of the application and cost.

Crouzet Control also ensures that its products are manufactured in compliance with quality and environmental standards (factories certified ISO 9001, 14001 and OHSAS 18001, eco-design).

With its industrial and logistic flexibility Crouzet Control is able to deliver products, whether small-scale or mass production items, in the best possible timescale.

Within this counter catalogue, Crouzet Control presents:

Over 120 recently launched ergonomic counters for better equipment integration including small formats..

New electromechanical range:

- Dual function hour counter and energy meter
- Dual function hour and impulse counter displays

New electronic range:

- Counters with backlit double LCD or two colour display
- Multi-function Counters
- Counters that integrate a Tachometer function



In addition to this catalogue, the **www.crouzet-control.com** website offers the latest tools, available as free downloads, including M3 Soft software, technical data sheets for each product and installation manuals.



InnoVista Sensors™

your trusted partner of choice to face industrial challenges of today and tomorrow

InnoVista Sensors™ is a worldwide industrial specialist of sensors, controllers and actuators for automated systems.

Through its brands, Crouzet Aerospace, Crouzet Automation, Crouzet Control, Crouzet Motors, Crouzet Switches and Systron Donner Inertial, InnoVista Sensors™ offers a wide range of reliable, efficient and customizable components dedicated to the Aerospace & Defence, Transportation and Industrial market and segments.

Thanks to the recognized expertise of its teams and a strong innovation policy, InnoVista Sensors™ brings performance enhancing solutions to its customers worldwide.

The Crouzet Control team worldwide



The basics

A counter, a ratemeter

How can they be defined in simple terms?

A **counter** can be used to count a number of actions or events.

It thus participates in production management and preventive maintenance.

A **ratemeter** can be used to display the speed of rotation of a motor in real time.

A counter, a ratemeter

To execute which actions?

Up counting, Down counting

For **up counting** or **down counting** a number of parts, events, a running time, the counter is the ideal solution. There are different types of counter with the following functions: up/down counter, batch counter, ratemeter, chronometer, multi-totalizer, elapsed time counter, impulse counter.

Informing, Displaying

A counter can allow a user to be **informed** and to **display** data and quantities easily. The data displayed can be read directly on the front panel.

Tripping, Actuating

A counter can be used to **trip** an action or an intervention on a machine. The outputs **actuate** directly and/or transmit data to the control system.

Measuring, Chronometer timing

A counter can be used to schedule preventive maintenance. The machine running time is **measured** and the duration of an action **timed with a chronometer**.

Up counting

Down counting

Informing

Displaying

Tripping

Actuating Measuring

Chronometer timing



In addition to this catalogue, the www.crouzet-control.com website offers technical data sheets for each product and installation manuals, available as free downloads.

Crouzet Control counters and ratemeters

A digital range and an electromechanical range



Counters and Ratemeters

Crouzet Control counters and ratemeters

Their features:

- For fast count applications, a high-speed counting frequency: up to **50 kHz**.
- A **two-colour or backlit LCD dual display** for ease of reading.
- Considerable space saving due to **dual-function** electromechanical and electronic ranges.
- A **complete** output operating **logic** to cover complex applications.
- **Easier maintenance** thanks to removable connectors (CTR48).
- An enhanced **multifunction** electronic range **for optimised stocks**.

Applications



Crouzet Control counters and ratemeters Where are they found?

In electrical cabinets associated with other automation functions for the following markets:

- Industrial automation systems
- Building equipment
- Industrial machines
- Medical

Tachometer systems



Speed measurement and control on shrink wrapping machine.



ELECTRONIC COUNTER
CTR24L 2511

Counting quantities



Managing quantities - Packaging by unit, batch or series of batches.



ELECTRONIC COUNTER
CTR48

Metric counting



Calculation of cut length on wood and paper machines.



ELECTRONIC COUNTER
CTR48

Position control



Managing quantities - Calculation of distance of travel.



ELECTRONIC COUNTER
CTR48

Compressors



Counting operating hours and counting the number of starts.



ELECTROMECHANICAL HOUR AND IMPULSE COUNTER CMM48

Dehumidifiers



Counting operating hours, energy consumption.



ELECTROMECHANICAL HOUR AND ENERGY COUNTER CEM48

Assembly line speed



Control of conveyor movement speed.



RATEMETER CTR24L 2511

Milling machine



Combined ratemeter and counter for controlling the position and speed of a router.



ELECTRONIC RATEMETER AND COUNTERS CTR24L 2513

Lifts



Combined impulse and hour counters - Maintenance. Start counters and operating time counters.



ELECTRONIC COUNTER CTR24L 2514

UV lamp



Counting and display of operating times. Event management, wear control.



HOUR COUNTER CTR24 2323





Counters and Ratemeters

Selection guide







Electronic counters

24 x 48 multifunction counters without preselection

Functions	Modes	Multiplication coefficient/ Decimal point	Max. counting speed
 Totalizer or Hour counter or Ratemeter	Dir/up.dn/up.up Ph/2-ph/4-ph	Yes/Yes	50 kHz
	Start/Stop	No/Yes	999,999 hrs
	sec -1/min -1	Yes/Yes	50 kHz
 Double totalizer Independent inputs (A and B)	Counting A/B/A-B/A+B AdivB/%AB	Yes/Yes	25 kHz
 Totalizer and Ratemeter Independent inputs	Dir/up.dn/up.up Ph/2-ph/4-ph	Yes/Yes	30 kHz
	sec -1/min -1		
 Double totalizer Common input	Counting (total/partial)	Yes/Yes	50 kHz
 Totalizer + Ratemeter or Totalizer + Totalizer or Totalizer + Hour or Hour + Hour	Counting + sec -1/min -1	Yes/Yes	35 kHz
	Counting		50 kHz
	Counting + Start/Stop		40 kHz
	Start/Stop		999,999 hrs
	Start/Stop	No/Yes	999,999 hrs

24 x 48 counters without preselection

Functions	Inputs/Reset	Max. counting speed	Display
 Hour	PNP/Contact	99,999.99 hrs	LCD
	NPN/Contact		
	Voltage/Contact		
 Hour	PNP/Contact	99,999.99 hrs	Orange (backlit)
	NPN/Contact		
	Voltage/Contact		
 Totalizer	Voltage/Contact	99,999,999	LCD
	PNP/Contact		
	NPN/Contact		
 Totalizer	Voltage/Contact	99,999,999	Orange (backlit)
	PNP/Contact		
	NPN/Contact		





Display	Counting capacity	Supply	Part number	Type	Page
LED	999,999	10 ⇒ 30 V $\overline{\text{---}}$	87 623 570	CTR24L - 2511	32
	0.001 s ⇒ 999,999 hrs				
	999,999				
LED	999,999	10 ⇒ 30 V $\overline{\text{---}}$	87 623 571	CTR24L - 2512	36
LED	999,999	10 ⇒ 30 V $\overline{\text{---}}$	87 623 572	CTR24L - 2513	40
LED	999,999	10 ⇒ 30 V $\overline{\text{---}}$	87 623 573	CTR24L - 2514	44
LED	999,999	10 ⇒ 30 V $\overline{\text{---}}$	87 623 574	CTR24L - 2515	48
	999,999 0.001 s ⇒ 999,999 hrs				
	0.001 s ⇒ 999,999 hrs				

Counting capacity	Supply	Part number	Type	Page
0.1 s ⇒ 99,999.99 hrs	Lithium battery	87 622 161	CTR24 - 2223	52
		87 622 162	CTR24 - 2233	52
		87 622 170	CTR24 - 2224	52
0.1 s ⇒ 99,999.99 hrs	Lithium battery	87 622 181	CTR24 - 2323	52
		87 622 182	CTR24 - 2333	52
		87 622 190	CTR24 - 2324	52
99,999,999	Lithium battery	87 610 340	CP2 - 2108	52
		87 622 061	CTR24 - 2241	56
		87 622 062	CTR24 - 2251	56
		87 622 070	CTR24 - 2242	56
99,999,999	Lithium battery	87 622 081	CTR24 - 2341	56
		87 622 082	CTR24 - 2351	56
		87 622 090	CTR24 - 2342	56

The counters and ratemeters accessories guide is available on the product data sheets which can be downloaded from the website www.crouzet-control.com





Selection guide

48 x 48 multifunction counters with preselection

	Functions	Number of preset(s)	Max. counting speed	Display
	Preselection counter Ratemeter Chronometer Multi-totalizer	1	40 KHz	Backlit LCD (orange) extra-bright 2 lines
	Preselection counter Ratemeter Chronometer Multi-totalizer Batch counter	2		
	Preselection counter Ratemeter Chronometer Multi-totalizer	1	40 KHz	Two-colour LCD (red and green) 2 lines
	Preselection counter Ratemeter Chronometer Multi-totalizer Batch counter	2		
	Preselection counter Chronometer	1	5 KHz	Backlit LCD (green) 2 lines
	Preselection counter Chronometer	2		

Electromechanical counters

Hour counters

	Dimensions (mm)	Counting capacity
	48 x 48	99,999.99
	48 x 48	999,999.99
	24 x 48	99,999.99
	15 x 32	999,999.99 99,999.99
	Modular DIN rail 35 mm	99,999.99

Counting capacity	Outputs	Supply	Part number	Type	Page
-999,999 ⇒ 999,999	1 x 5 A changeover 1 solid state	10 ⇒ 30 V $\overline{\text{---}}$	87 621 111	CTR48	18
		24 V \sim	87 621 112	CTR48	18
		90 ⇒ 260 V \sim	87 621 115	CTR48	18
	1 x 5 A changeover 1 x 5 A N/O 2 solid state	10 ⇒ 30 V $\overline{\text{---}}$	87 621 121	CTR48	18
		24 V \sim	87 621 122	CTR48	18
		90 ⇒ 260 V \sim	87 621 125	CTR48	18
-999,999 ⇒ 999,999	1 x 5 A changeover 1 solid state	10 ⇒ 30 V $\overline{\text{---}}$	87 621 211	CTR48	18
		24 V \sim	87 621 212	CTR48	18
		90 ⇒ 260 V \sim	87 621 215	CTR48	18
	1 x 5 A changeover 1 x 5 A N/O 2 solid state	10 ⇒ 30 V $\overline{\text{---}}$	87 621 221	CTR48	18
		24 V \sim	87 621 222	CTR48	18
		90 ⇒ 260 V \sim	87 621 225	CTR48	18
-999,999 ⇒ 999,999	1 x 3 A changeover	11 ⇒ 30 V $\overline{\text{---}}$	87 629 111	CTR48E	26
		115 V \sim	87 629 113	CTR48E	26
		230 V \sim	87 629 114	CTR48E	26
	1 x 3 A changeover 1 x 3 A N/O	11 ⇒ 30 V $\overline{\text{---}}$	87 629 121	CTR48E	26
		115 V \sim	87 629 123	CTR48E	26
		230 V \sim	87 629 124	CTR48E	26

Frequency	Supply	Part number	Type	Page
50 Hz \sim	20 ⇒ 30 V \sim	99 772 710	CHM48	60
	42 ⇒ 48 V \sim	99 772 711	CHM48	60
	100 ⇒ 130 V \sim	99 772 712	CHM48	60
	360 ⇒ 440 V \sim	99 772 713	CHM48	60
	187 ⇒ 264 V \sim	99 772 714	CHM48	60
60 Hz \sim	20 ⇒ 30 V \sim	99 772 718	CHM48	60
	42 ⇒ 48 V \sim	99 772 719	CHM48	60
	100 ⇒ 130 V \sim	99 772 715	CHM48	60
	360 ⇒ 440 V \sim	99 772 717	CHM48	60
	187 ⇒ 264 V \sim	99 772 716	CHM48	60
$\overline{\text{---}}$	10 ⇒ 30 V $\overline{\text{---}}$	99 772 810	CHM48	60
	36 ⇒ 80 V $\overline{\text{---}}$	99 772 811	CHM48	60
	100 ⇒ 130 V $\overline{\text{---}}$	99 772 812	CHM48	60
50 Hz \sim	20 ⇒ 30 V \sim	99 782 710	CHM24	62
	100 ⇒ 130 V \sim	99 782 712	CHM24	62
	187 ⇒ 264 V \sim	99 782 714	CHM24	62
60 Hz \sim	20 ⇒ 30 V \sim	99 782 718	CHM24	62
	100 ⇒ 130 V \sim	99 782 715	CHM24	62
	187 ⇒ 264 V \sim	99 782 716	CHM24	62
$\overline{\text{---}}$	10 ⇒ 30 V $\overline{\text{---}}$	99 782 810	CHM24	62
$\overline{\text{---}}$	4.5 ⇒ 35 V $\overline{\text{---}}$	99 792 810	CHM15	64
50 Hz \sim	24 V \sim	99 793 710	CHMDR	65
	115 V \sim	99 793 712	CHMDR	65
	230 V \sim	99 793 714	CHMDR	65
$\overline{\text{---}}$	10 ⇒ 27 V $\overline{\text{---}}$	99 793 810	CHMDR	65

The counters and ratemeters accessories guide is available on the product data sheets which can be downloaded from the website www.crouzet-control.com



Selection guide



Impulse counters

	Dimensions (mm)	Reset to zero
	15 x 32 Clip-fixing	No
	24 x 48 Clip-fixing	No
	24 x 48 Clip-fixing	Yes
	24 x 48 Screw-fixing	No
	24 x 48 Screw-fixing	Yes
	36 x 37 Screw-fixing	No
	36 x 37 Screw-fixing	Yes
	36 x 48 Screw-fixing	No
	36 x 48 Screw-fixing	Yes

Dual function 48 x 48 counters

	Functions	Reset to zero	Counting capacity
	Impulse Hour	No	9,999,999 99,999.99 hrs
			9,999,999/999,999.99 hrs
	Hour Energy	No	99,999.9 hrs 99,999.9 kWh



Counting capacity	Supply	Part number	Type	Page
9,999,999	24 V ~ - 50/60 Hz	99 778 710	CIM 15	76
	115 V ~ - 50/60 Hz	99 778 712	CIM 15	76
	230 V ~ - 50/60 Hz	99 778 714	CIM 15	76
	5 V ☰	99 778 805	CIM 15	76
	12 V ☰	99 778 806	CIM 15	76
	24 V ☰	99 778 810	CIM 15	76
999,999	24 V ~ - 50/60 Hz	99 777 710	CIM 24	70
	230 V ~ - 50/60 Hz	99 777 714	CIM 24	70
	12 V ☰	99 777 815	CIM 24	70
	24 V ☰	99 777 810	CIM 24	70
99,999	24 V ~ - 50/60 Hz	99 777 720	CIM 24	70
	230 V ~ - 50/60 Hz	99 777 724	CIM 24	70
	12 V ☰	99 777 825	CIM 24	70
	24 V ☰	99 777 820	CIM 24	70
999,999	24 V ~ - 50/60 Hz	99 776 904	CIM 24 x 48	78
	115 V ~ - 50/60 Hz	99 776 902	CIM 24 x 48	78
	230 V ~ - 50/60 Hz	99 776 901	CIM 24 x 48	78
	24 V ☰	99 776 907	CIM 24 x 48	78
	110 V ☰	99 776 905	CIM 24 x 48	78
99,999	24 V ~ - 50/60 Hz	99 776 924	CIM 24 x 48	78
	115 V ~ - 50/60 Hz	99 776 922	CIM 24 x 48	78
	230 V ~ - 50/60 Hz	99 776 921	CIM 24 x 48	78
	24 V ☰	99 776 927	CIM 24 x 48	78
999,999	24 V ~ - 50/60 Hz	99 776 604	CIM 36 x 37	72
	115 V ~ - 50/60 Hz	99 776 602	CIM 36 x 37	72
	230 V ~ - 50/60 Hz	99 776 601	CIM 36 x 37	72
	24 V ☰	99 776 607	CIM 36 x 37	72
	110 V ☰	99 776 605	CIM 36 x 37	72
99,999	24 V ~ - 50/60 Hz	99 776 613	CIM 36 x 37	72
	115 V ~ - 50/60 Hz	99 776 611	CIM 36 x 37	72
	230 V ~ - 50/60 Hz	99 776 610	CIM 36 x 37	72
	24 V ☰	99 776 616	CIM 36 x 37	72
999,999	24 V ~ - 50/60 Hz	99 776 704	CIM 36 x 48	74
	115 V ~ - 50/60 Hz	99 776 702	CIM 36 x 48	74
	230 V ~ - 50/60 Hz	99 776 701	CIM 36 x 48	74
	24 V ☰	99 776 707	CIM 36 x 48	74
	48 V ☰	99 776 736	CIM 36 x 48	74
	110 V ☰	99 776 705	CIM 36 x 48	74
99,999	24 V ~ - 50/60 Hz	99 776 713	CIM 36 x 48	74
	115 V ~ - 50/60 Hz	99 776 711	CIM 36 x 48	74
	230 V ~ - 50/60 Hz	99 776 710	CIM 36 x 48	74
	24 V ☰	99 776 716	CIM 36 x 48	74

Counters and Ratemeters

Frequency	Supply	Part number	Type	Page
50 Hz ~	20 ⇨ 30 V ~	99 779 710	CMM48	68
	100 ⇨ 130 V ~	99 779 712	CMM48	68
	187 ⇨ 264 V ~	99 779 714	CMM48	68
60 Hz ~	20 ⇨ 30 V ~	99 779 718	CMM48	68
	100 ⇨ 130 V ~	99 779 715	CMM48	68
	187 ⇨ 264 V ~	99 779 716	CMM48	68
☰	10 ⇨ 30 V ☰	99 779 810	CMM48	68
50 Hz ~	115 V ~	99 780 712	CEM48	68
	230 V ~	99 780 714	CEM48	68

The counters and ratemeters accessories guide is available on the product data sheets which can be downloaded from the website www.crouzet-control.com

Connection diagrams

CTR24 counters

Connections

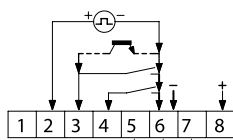
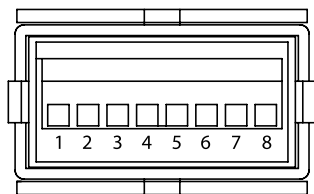

9999h59m59s			
9999999.9s	●	●	
99999h59m	●	●	
99999.99h	●	●	

Types 2223 and 2323:

Part numbers:

- 87 622 161
- 87 622 181

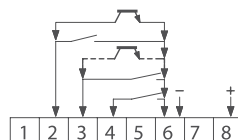
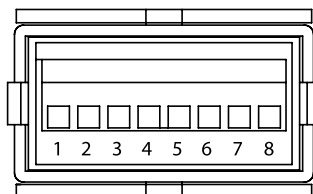

9999h59m59s			
9999999.9s	●	●	
99999h59m	●	●	
99999.99h	●	●	

Types 2233 and 2333:

Part numbers:

- 87 622 162
- 87 622 182

1. NC
2. Start/Stop input
3. Reset input
4. Enable front panel Reset
5. Mode 1 (Time selection)
6. GND/Optional backlighting - (only 23xx)
7. Mode 2 (Time selection)
8. Optional backlighting + (only 23xx)

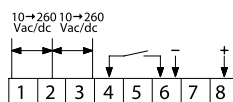
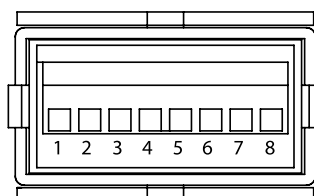

9999h59m59s			
9999999.9s	●	●	
99999h59m	●	●	
99999.99h	●	●	

Types 2224 and 2324:

Part numbers:

- 87 622 170
- 87 622 190

1. Common \sim
2. Start/Stop input
3. Reset input
4. Enable front panel Reset
5. Mode 1 (Time selection)
6. GND/Optional backlighting - (only 23xx)
7. Mode 2 (Time selection)
8. Optional backlighting + (only 23xx)

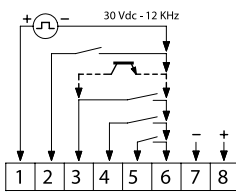
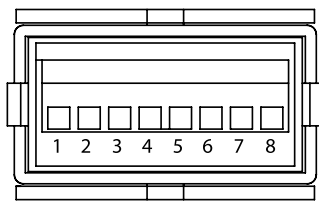

Types 2241 and 2341:

Part numbers:

- 87 622 061
- 87 622 081

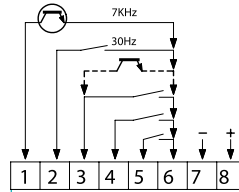
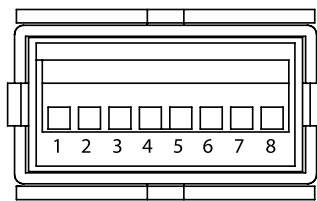

Types 2251 and 2351:

Part numbers:

- 87 622 062
- 87 622 082

1. Fast count
2. Slow count
3. Reset input
4. Enable front panel Reset
5. Counting (counting direction)
6. GND
7. Optional backlighting - (only 23xx)
8. Optional backlighting + (only 23xx)

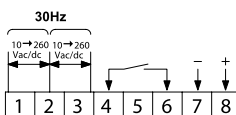
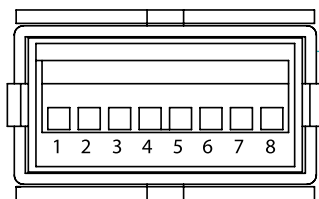

Types 2242 and 2342:

Part numbers:

- 87 622 070
- 87 622 090

1. Fast count
2. Common \sim
3. Reset input
4. Enable front panel Reset
5. NC
6. GND
7. Optional backlighting - (only 23xx)
8. Optional backlighting + (only 23xx)

Counters and Ratemeters

Crouzet Control, Technology and expertise, behind every project

- **Local** support for all industrial projects.
- A **multi-skilled** team.
- A sales presence in over **40 countries**.
- A Premium offer designed to ensure the **excellence** of products and services.
- **Eco-design integrated** in Crouzet's Offer Creation Process.
- Certifications: **ISO 9001, ISO 14001, OHSAS 18001**.
- Products which **comply with international standards** (UL, CSA, EC).
- A **dynamic R&D** department.



In addition to this catalogue, the **www.crouzet-control.com** website offers the latest tools, available as free downloads, including M3 Soft software, technical data sheets for each product and installation manuals.



Data sheets

- Up counters / Down counters - 48 x 48 - CTR48 P. 18
- Up counters / Down counters - 48 x 48 - CTR48E - Essential P. 26
- Multifunction counter - LED 24 x 48 - CTR24L P. 32
- Multifunction counter with 2 totalizers - LED 24 x 48 - CTR24L P. 36
- Multifunction counter combining a totalizer and tachometer - LED 24 x 48 - CTR24L P. 40
- Multifunction counter with 2 totalizers (total an partial function) with common input - LED 24 x 48 - CTR24L P. 44
- "DUO" multifunction counter - LED 24 x 48 - CTR24L P. 48
- Hour counters without preselection - LCD 24 x 48 - CTR24 P. 52
- Totalizers without preselection - LCD 24 x 48 - CTR24 P. 56
- Hour counters 48 x 48 - CHM48 P. 60
- Hour counters 24 x 48 - CHM24 P. 62
- Hour counters 15 x 32 - CHM15 P. 64
- DIN rail mounting hour counters - CHMDR P. 65
- Dual-function counter (hour counter and watt-hour meter) 48 x 48 - CEM48 P. 66
- Dual-function counter (hour counter and impulse counter) 48 x 48 - CMM48 P. 68
- Impulse counters 24 x 48 - CIM24 P. 70
- Impulse counters 36 x 37 - CIM P. 72
- Impulse counters 36 x 48 - CIM P. 74
- Impulse counters with built-in fixing clip 15 x 32 - CIM15 P. 76
- Screw-fixing implulse counters 24 x 48 - CIM P. 78



To order:
Customer Service
Crouzet Control
Tel.: +33 (0) 475 802 102
customer.relation@crouzet.com



Electronic multifunction counters with preselection

→ Up counters / Down counters - 48 x 48 - CTR48

- Counter, Tachometer, Chronometer, Multi-totalizer, Batch counter, Preselection totalizer
- Maximum input frequency 40 kHz
- Simple parameter setting, configuration using text menus
- Easy modification of presets
- Scaling factor
- 5 A changeover relay and solid state output
- Removable connectors
- Backlit LCD display (orange) : 2 lines, 6 digits or multicoloured display (green-red)
- IP 65 sealed panel
- Option of locking the keypad, completely or partially (preset, programming)
- Accessories for 72 x 72 or 55 x 55 cut-out, DIN rail adaptor



Part numbers

Type	Functions	Preset	Voltages	Output	Code
Orange backlight LCD display	Counter, Tachometer, Chronometer, Preselection multi-totalizer	1	10 → 30 V $\overline{\text{---}}$	1 changeover relay, 1 solid state	87621111
	Counter, Tachometer, Chronometer, Preselection multi-totalizer	1	24 V \sim	1 changeover relay, 1 solid state	87621112
	Counter, Tachometer, Chronometer, Preselection multi-totalizer	1	90 → 260 V \sim	1 changeover relay, 1 solid state	87621115
	Counter, Tachometer, Chronometer, Multi-totalizer, Batch counter, Preselection totalizer	2	10 → 30 V $\overline{\text{---}}$	1 changeover relay, 1 NO relay, 2 solid state	87621121
	Counter, Tachometer, Chronometer, Multi-totalizer, Batch counter, Preselection totalizer	2	24 V \sim	1 changeover relay, 1 NO relay, 2 solid state	87621122
	Counter, Tachometer, Chronometer, Multi-totalizer, Batch counter, Preselection totalizer	2	90 → 260 V \sim	1 changeover relay, 1 NO relay, 2 solid state	87621125
Multicoloured LCD display (green-red)	Counter, Tachometer, Chronometer, Preselection multi-totalizer	1	10 → 30 V $\overline{\text{---}}$	1 changeover relay, 1 solid state	87621211
	Counter, Tachometer, Chronometer, Preselection multi-totalizer	1	24 V \sim	1 changeover relay, 1 solid state	87621212
	Counter, Tachometer, Chronometer, Preselection multi-totalizer	1	90 → 260 V \sim	1 changeover relay, 1 solid state	87621215
	Counter, Tachometer, Chronometer, Multi-totalizer, Batch counter, Preselection totalizer	2	10 → 30 V $\overline{\text{---}}$	1 changeover relay, 1 NO relay, 2 solid state	87621221
	Counter, Tachometer, Chronometer, Multi-totalizer, Batch counter, Preselection totalizer	2	24 V \sim	1 changeover relay, 1 NO relay, 2 solid state	87621222
	Counter, Tachometer, Chronometer, Multi-totalizer, Batch counter, Preselection totalizer	2	90 → 260 V \sim	1 changeover relay, 1 NO relay, 2 solid state	87621225

Accessories

Description	Code
Adaptor for 72 x 72 mm cut-out	26546842
Adaptor for 55 x 55 mm cut-out	26546846
DIN rail adaptor	26546841

General characteristics

Environmental characteristics

Supply	10 → 30 V $\overline{\text{---}}$ / 24 V \sim / 90 → 260 V \sim
Relative humidity (no condensation)	EN 60068-2-30 40/93% RLF
Altitude	0 < 2000 m
Certifications	UL - cULus (pending) - CE
Vibration resistance in 3 axes	10-55 Hz / 1 min / XYZ EN 60068-2-6: 30 min. in each direction
Connection by screw terminals	Removable
Protection	Conforming to standard EN 60529 IP65 for panel / IP20 for connections
Front panel watertight seal	✓
Temperature limits use (°C)	-20 → +65
Temperature limits stored (°C)	-25 → +75
Weight (g)	150 $\overline{\text{---}}$ version 250 \sim version

General characteristics

Reset to zero or to preset	On panel: if not locked during programming Electrical: automatic, voltage or solid state (NPN or PNP depending on programming)
Minimum pulse time	Impulse counter: < 15 ms Chronometer: 500 μ s
Option to protect against reset from front panel	✓
Scale factor (each input pulse is multiplied by this figure)	00.0001 → 99.9999
Scaling factor (each input impulse is divided by this value)	01.0000 → 99.9999
Decimal point selectable for ease of reading	0 0.0 0.00 0.000 0.0000 0.00000
Sensor supply version \sim	24 V $\overline{\text{---}}$ -20/+15% 50 mA
Programming and current value backed up via EEPROM memory	✓ Service life 10 years

Operating characteristics

Functions	Preselection counter, Tachometer, Chronometer, Multi-totalizer, Batch counters, Totalizer
Number of presets	1 or 2
Display	LCD with orange backlighting/Multicoloured LCD (green-red)
Height digits (mm)	LCD 9
Display details	- 999 999 → 999 999

Input characteristics

Inputs	2 counter inputs 1 reset input, 1 gate input
Input modes	Dir: Directional AS: up/dn AA: up/up PP: phase PP2: phase 2 PP4: phase 4
Input type	Voltage or solid state
High level	8 V $\overline{\text{---}}$ → 30 V $\overline{\text{---}}$
Low level	0 → 2 V $\overline{\text{---}}$

Solid state output characteristics

Maximum current	30 mA
Max. voltage	10 → 30 V $\overline{\text{---}}$ for the $\overline{\text{---}}$ version 24 V $\overline{\text{---}}$ -20/+15%

Relay output characteristics

Changeover relay	✓
NO contact	Depending on version
Maximum current	5 A
Minimum current	10 mA
Maximum voltage	30 V $\overline{\text{---}}$ / 250 V \sim
Min. voltage	5 V \sim
Response time	< 13 ms
Mechanical life (operations)	20 x 10 ⁶
Number of operations to 5 A	5 x 10 ⁴
Output modes: maintained or pulsed	0.01 → 99.99 s

Dimensions (mm)

26546842 - Adaptor for 72 x 72 mm cut-out

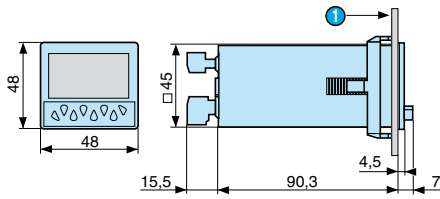

① 10.5 max.

26546846 - Adaptor for 55 x 55 mm cut-out

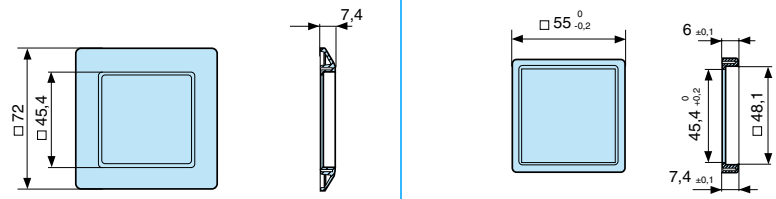

Panel cut-out

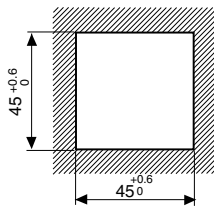

26546841 - DIN rail adaptor

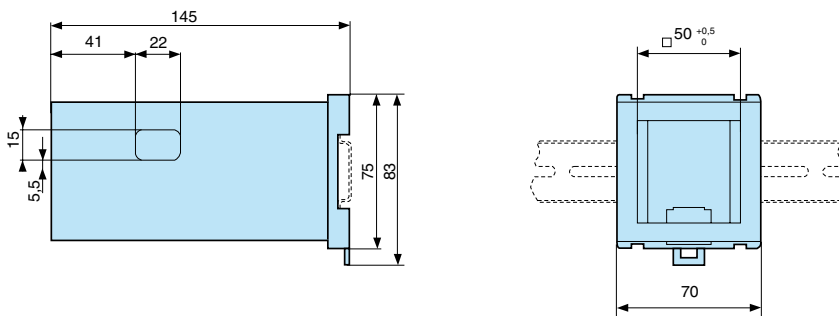

Principles

Display and buttons

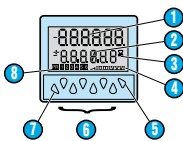

- ① Current value
- ② Selected value
- ③ Chronometer display
- ④ Active output indication
- ⑤ Prog/mode button
- ⑥ Preset control buttons
- ⑦ Button required for programming parameters
- ⑧ Shows which value is displayed

Connections

87621111 / 211

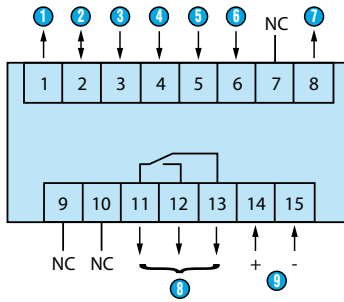

- ① Sensor voltage supply (* UB interconnected)
- ② GND (0 V $\overline{\text{---}}$)
- ③ INP A (signal A input)
- ④ INP B (signal B input)
- ⑤ Reset (Reset input)
- ⑥ Gate input
- ⑦ Output 1 - 10-30 V $\overline{\text{---}}$ /30 mA
- ⑧ 11-12-13: Output 1
- ⑨ 14-15: Supply

Output: 5 A/250 V \sim /AC: 24 V \sim

87621121 / 221

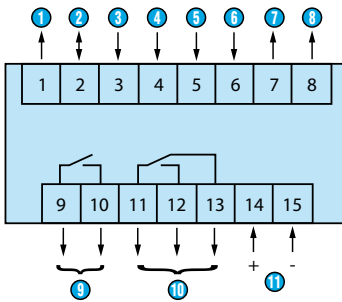

- ① Sensor voltage supply (* UB interconnected)
- ② GND (0 V $\overline{\text{---}}$)
- ③ INP A (signal A input)
- ④ INP B (signal B input)
- ⑤ Reset (Reset input)
- ⑥ Gate input
- ⑦ Output 1: 10-30 V $\overline{\text{---}}$ /30 mA
- ⑧ Output 2: 10-30 V $\overline{\text{---}}$ /30 mA
- ⑨ 9-10: Output 1
- ⑩ 11-12-13: Output 2
- ⑪ 14-15: Supply

Output: 5 A/250 V \sim / AC: 90 \rightarrow 260 V $\overline{\text{---}}$

87621112 / 212

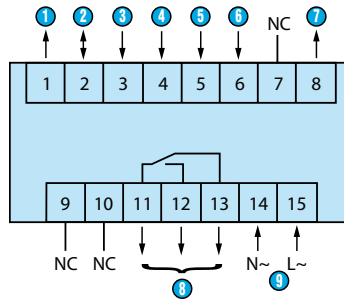

- ① Sensor voltage supply
- ② GND (0 V $\overline{\text{---}}$)
- ③ INP A (signal A input)
- ④ INP B (signal B input)
- ⑤ Reset (Reset input)
- ⑥ Gate input
- ⑦ Output 1 - 24 V $\overline{\text{---}}$ /30 mA
- ⑧ 11-12-13: Output 1
- ⑨ 14-15: Supply

Output: 5 A/250 V \sim /AC: 24 V \sim

87621122 / 222

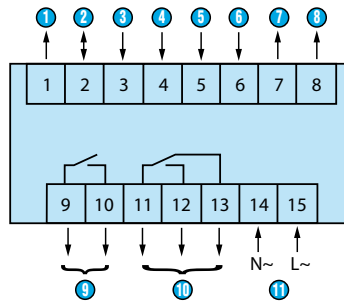

- ① Sensor voltage supply
- ② GND (0 V $\overline{\text{---}}$)
- ③ INP A (signal A input)
- ④ INP B (signal B input)
- ⑤ Reset (Reset input)
- ⑥ Gate input
- ⑦ Output 1: 24 V $\overline{\text{---}}$ /30 mA
- ⑧ Output 2: 24 V $\overline{\text{---}}$ /30 mA
- ⑨ 9-10: Output 1
- ⑩ 11-12-13: Output 2
- ⑪ 14-15: Supply

Output: 5 A/250 V \sim / AC: 90 \rightarrow 260 V $\overline{\text{---}}$

87621115 / 215

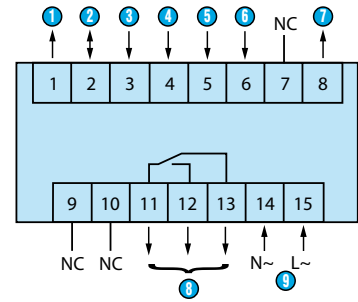

- ① Sensor voltage supply
- ② GND (0 V $\overline{\text{---}}$)
- ③ INP A (signal A input)
- ④ INP B (signal B input)
- ⑤ Reset (Reset input)
- ⑥ Gate input
- ⑦ Output 1 - 24 V $\overline{\text{---}}$ /30 mA
- ⑧ 11-12-13: Output 1
- ⑨ 14-15: Supply

Output: 5 A/250 V \sim / AC: 24 V \sim

87621125 / 225

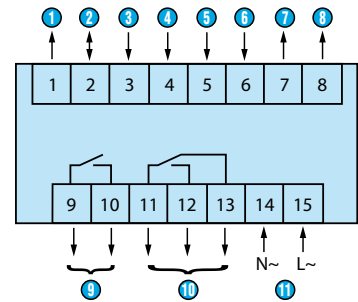

- ① Sensor voltage supply
- ② GND (0 V $\overline{\text{---}}$)
- ③ INP A (signal A input)
- ④ INP B (signal B input)
- ⑤ Reset (Reset input)
- ⑥ Gate input
- ⑦ Output 1: 24 V $\overline{\text{---}}$ /30 mA
- ⑧ Output 2: 24 V $\overline{\text{---}}$ /30 mA
- ⑨ 9-10: Output 1
- ⑩ 11-12-13: Output 2
- ⑪ 14-15: Supply

Output: 5 A/250 V \sim / AC: 90 \rightarrow 260 V $\overline{\text{---}}$

Applications

Programming diagram

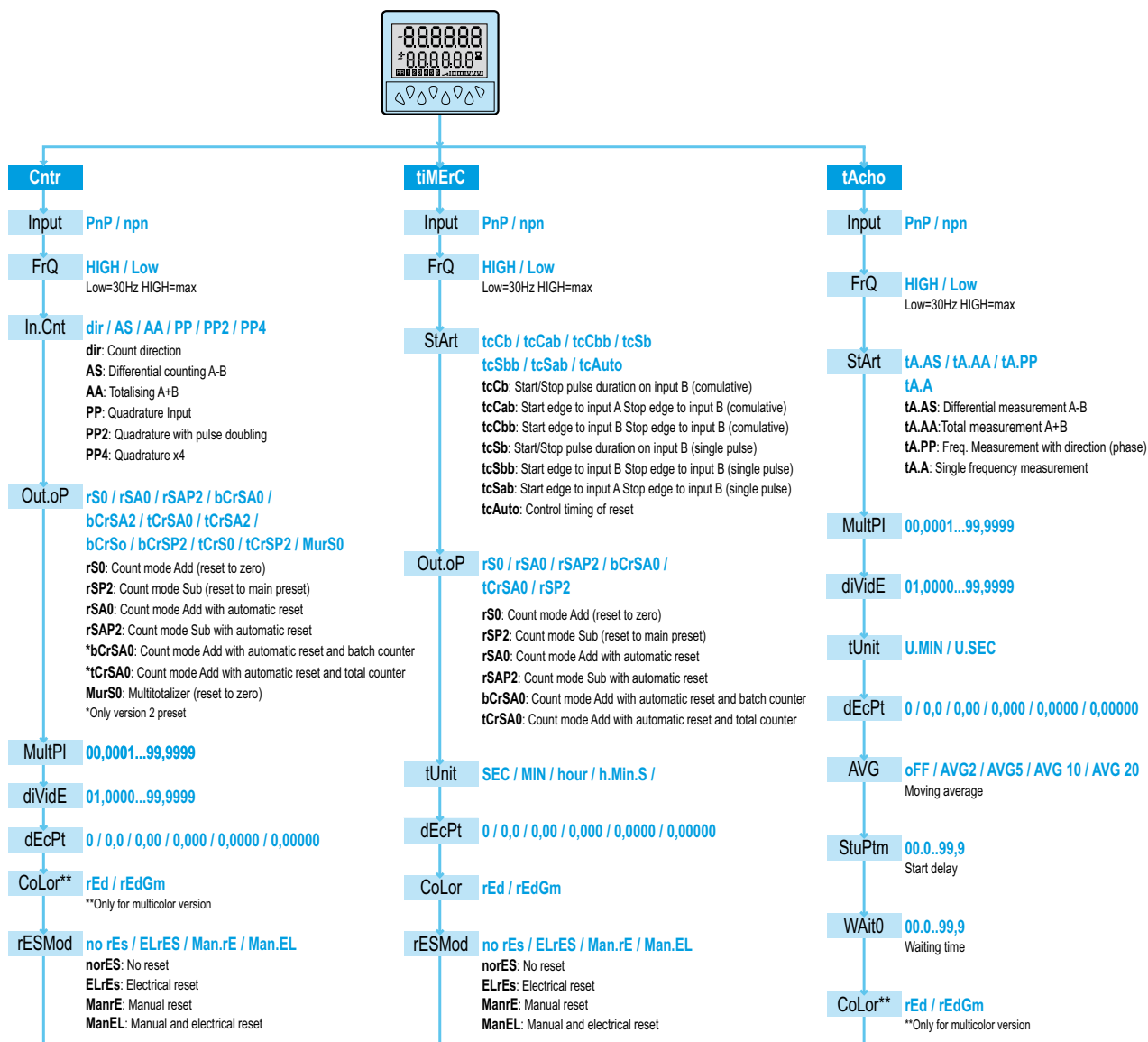

Counter

Output operation modes	rSo / rSP2 bCrS0 bCrSP2 tCrS0 tCrSP2 MurS0	rSA0	rSAP2 bCrSA0 bCrSA2 tCrSA0 tCrSA2
dir	40 kHz	5.2 kHz	4.2 kHz
AS	20 kHz	4.4 kHz	4.2 kHz
AA			
PP	20 kHz	2.2 kHz	2.1 kHz
PP2	15 kHz	1.1 kHz	1.0 kHz

Tachometer

tA.A	
tA.AS	40 kHz
tA.AA	
Quad	20 kHz



tiMES1 00.01..99,99s
Time signal output regulation

P1 Loc / UnLoc / Loc-tr
Loc: Preset value is locked
UnLoc: Preset value is open
UnLoc-tr: Preset value is locked is possible to open with pression key with 10s

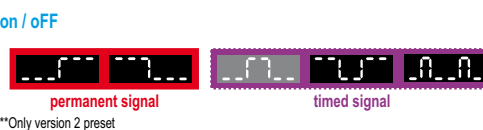

tiMES2 00.01..99,99s
Time signal output regulation

P2 Loc / UnLoc / Loc-tr
Loc: Preset value is locked
UnLoc: Preset value is open
UnLoc-tr: Preset value is locked is possible to open with pression key with 10s

PrG Loc / UnLoc
Loc: Press Key R and P into 15s after powerOn to enter in the programming
UnLoc: Press Key R and P for 3 sec to enter in the programming

Curves

Counter: dir

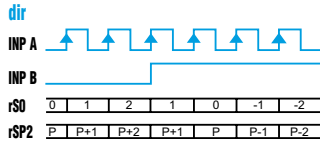

Inp A: counter input
 Inp B: count direction
 rS0: Display 0 → Preset
 rSP2: Display Preset → 0

Counter: AS

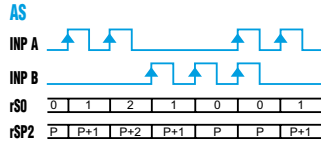

Inp A: Add. counter input 1
 Inp B: sub. counter input 2
 rS0: Display 0 → Preset
 rSP2: Display Preset → 0

Counter: AA

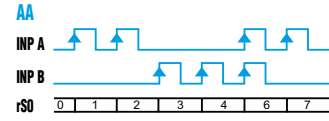

Inp A: Add. counter input 1
 Inp B: sub. counter input 2
 rS0: Display 0 → Preset

Counter: PP

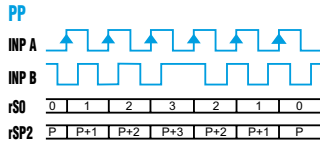

A 90° B
 Inp A: Counter input
 Counting on an edge
 Inp B: Reversal of direction
 rS0: Display 0 → Preset
 rSP2: Display Preset → 0

Counter: PP2

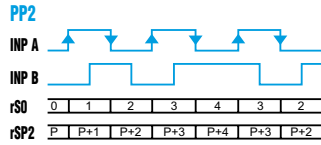

A 90° B
 Inp A: Counter input
 Counting on a rising edge and on a falling edge
 Inp B: Reversal of direction
 rS0: Display 0 → Preset
 rSP2: Display Preset → 0

Counter: PP4

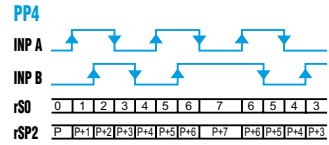

A 90° B
 Inp A: Counter input
 Counting on a rising edge and on a falling edge
 Inp B: Counter input
 Counting on a rising edge and on a falling edge, reversal of direction
 rS0: Display 0 → Preset
 rSP2: Display Preset → 0

Chronometer: Start tcCb

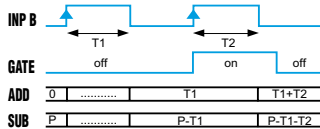

Inp A: No function
 Inp B: On/Off
 Cumulative time counting
 Add: Display 0 → Preset
 Sub: Display Preset → 0

Chronometer: Start tcCbb

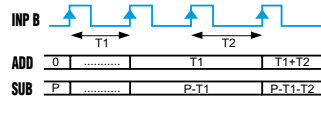

Inp A: No function
 Inp B: On/Off
 Cumulative time counting
 Add: Display 0 → Preset
 Sub: Display Preset → 0

Chronometer: Start tcCAb

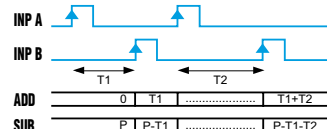

Inp A: On
 Inp B: Off
 Cumulative time counting
 Add: Display 0 → Preset
 Sub: Display Preset → 0

Chronometer: Start tcSb

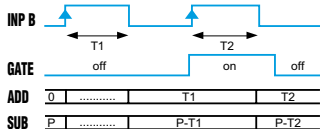

Inp A: No function
 Inp B: On/Off
 Individual time counting while B is active, automatic reset before each new count
 Add: Display 0 → Preset
 Sub: Display Preset → 0

Chronometer: Start tcSbb

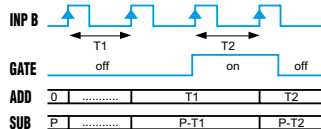

Inp A: No function
 Inp B: On/Off
 Individual time counting, automatic reset before each new count
 Add: Display 0 → Preset
 Sub: Display Preset → 0

Chronometer: Start tcSAb

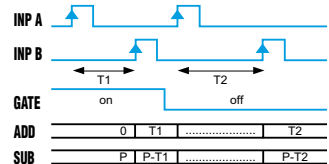

Inp A: On
 Inp B: Off
 Individual time counting, automatic reset before each new count
 Add: Display 0 → Preset
 Sub: Display Preset → 0

Chronometer: Start tcAuto

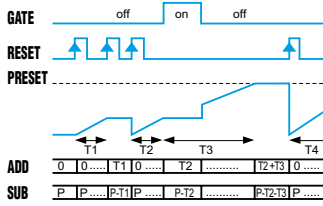

Inp A: No function
 Inp B: No function
 Time counting command via Reset (manual or electrical)
 Add: Display 0 → Preset
 Sub: Display Preset → 0
 The Gate input has a display memory function

Tachometer: Start tA.A

INP A	0	F _{A0}	F _{A1}	F _{A2}	0	x
Display	0	0	F _{A0}	F _{A1}	F _{A2}	0

Inp A: Frequency input
 Inp B: No function

Tachometer: Start tA.AS

INP A	0	F _{A0}	F _{A1}	F _{A2}	0	x
INP B	0	0	F _{B0}	F _{B1}	F _{B2}	x
Display	0	0	F _{A0}	F _{A0} -F _{B0}	F _{A1} -F _{B1}	-F _{B2}

Inp A: Frequency input 1
 Inp B: Frequency input 2
 Formula: A - B

Tachometer: Start tA.AA

INP A	0	F _{A0}	F _{A1}	F _{A2}	0	x
INP B	0	0	F _{B0}	F _{B1}	F _{B2}	x
Display	0	0	F _{A0}	F _{A0} +F _{B0}	F _{A1} +F _{B1}	F _{B2}

Inp A: Frequency input 1
 Inp B: Frequency input 2
 Formula: A + B

Tachometer: Start tA.PP

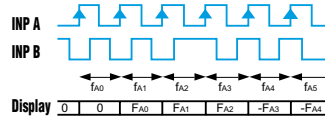

A 90° B
 Inp A: Frequency input 1
 Inp B: Reversal of direction

Output operation: OutoP rS0

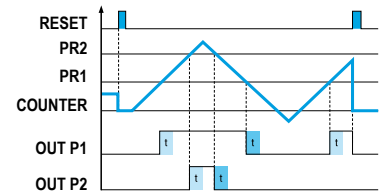

Output operation: OutoP rSA0

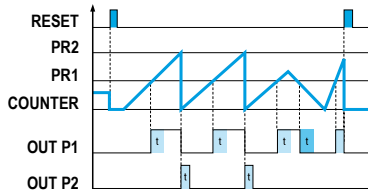

Output operation: OutoP bCrSA0

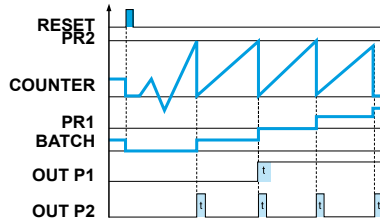

Output operation: OutoP tCrSA0

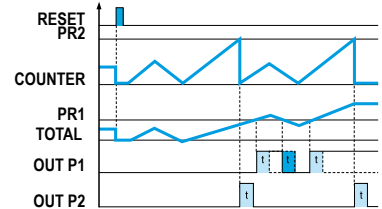

Output operation: OutoP rSP2

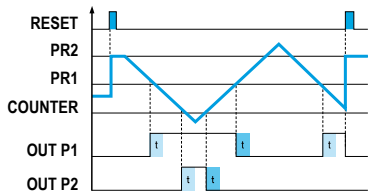

Output operation: OutoP rSAP2

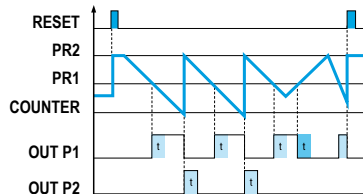

Output operation: OutoPbCrSA2

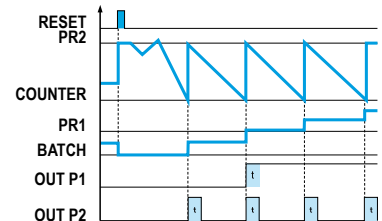

Output operation: OutoP tCrSA2

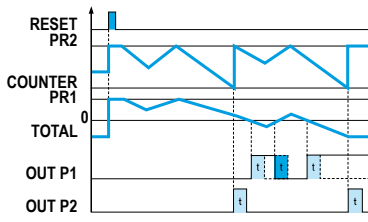

Output operation: OutoP bCrS0

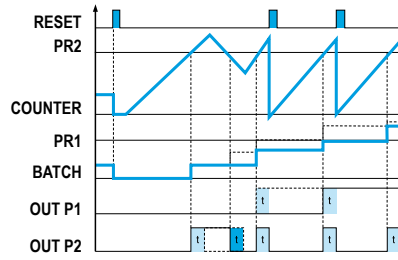

Output operation: OutoP tCrS0

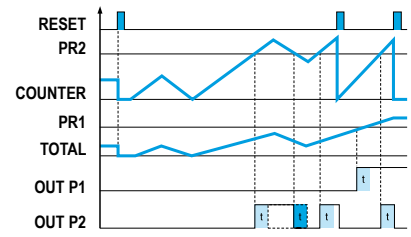

Output operation: OutoP MurS0 (AA)

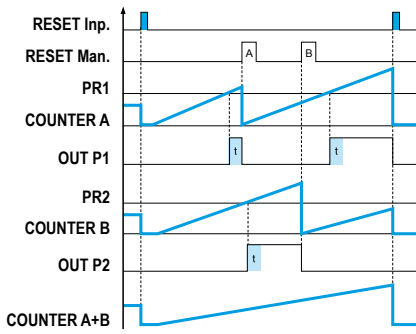

Output operation: OutoP bCrSP2

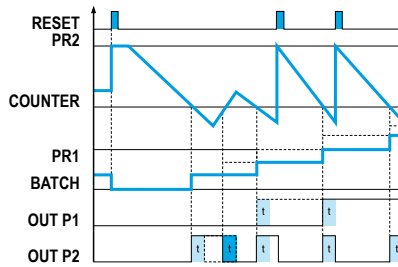

Output operation: OutoP tCrSP2

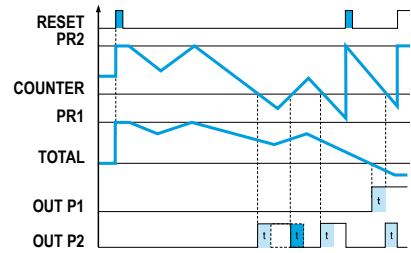

Output operation: OutoP MurS0 (AS)

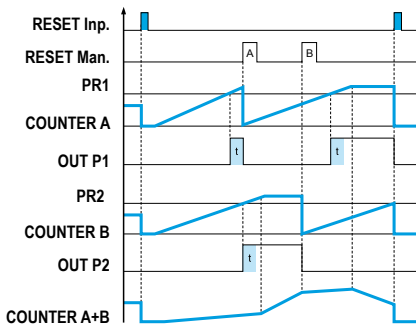

Electronic multifunction counters with preselection

→ Up counters/Down counters - 48 x 48 - CTR48E "Essential"

- Counter, Preselection chronometer
- Maximum input frequency 5 k Hz
- Simple parameter setting, configuration using text menus
- Easy modification of presets
- Multiplication factor
- 3 A changeover relay
- Backlit LCD display (green) : 6 digits, height 9 mm
- IP 65 sealed panel
- Option of locking the keypad, completely or partially (preset, programming)
- Accessories for 72 x 72 or 55 x 55 cut-out, DIN rail adaptor



Part numbers

Type	Functions	Preset	Voltages	Output	Code
Green backlit LCD display	Counter, Preselection chronometer	1	10 → 30 V $\overline{\text{DC}}$	1 relay	87629111
	Counter, Preselection chronometer	1	115 V \sim	1 relay	87629113
	Counter, Preselection chronometer	1	230 V \sim	1 relay	87629114
	Counter, Preselection chronometer	2	10 → 30 V $\overline{\text{DC}}$	1 changeover relay, 1 NO relay	87629121
	Counter, Preselection chronometer	2	115 V \sim	1 changeover relay, 1 NO relay	87629123
	Counter, Preselection chronometer	2	230 V \sim	1 changeover relay, 1 NO relay	87629124

Accessories

Description	Code
Adaptor for 72 x 72 mm cut-out	26546842
Adaptor for 55 x 55 mm cut-out	26546846
DIN rail adaptor	26546841

General characteristics

Environmental characteristics	
Supply	11 → 30 V $\overline{\text{DC}}$ / 115 V \sim / 230 V \sim
Relative humidity (no condensation)	EN 60068-2-30 40/93% RLF
Altitude	0 < 2000 m
Certifications	CE
Vibration resistance in 3 axes	10-55 Hz/1 min/XYZ EN 60068-2-6: 30 min. in each direction
Connection by screw terminals	Removable
Protection	Conforming to standard EN 60529 IP65 for panel/IP20 for connections
Front panel watertight seal	✓
Temperature limits use (°C)	-10 → +50
Temperature limits stored (°C)	-25 → +75
Weight (g)	150 $\overline{\text{DC}}$ version 250 \sim version
General characteristics	
Reset to zero or to preset	On panel: if not locked during programming Electrical: automatic, voltage or solid state (NPN or PNP depending on programming)
Minimum pulse time	Impulse counter: < 15 ms Chronometer: 500 μ s
Option to protect against reset from front panel	✓
Scale factor (each input pulse is multiplied by this figure)	00.0001 → 99.9999
Decimal point selectable for ease of reading	0 0.0 0.00 0.000 0.0000 0.00000
Sensor supply version \sim	-40/+15% 50 mA 230 V \sim -40/+15% 40 mA 115 V \sim
Programming and current value backed up via EEPROM memory	✓
	Service life 10 years

Operating characteristics	
Functions	Preselection counter, Chronometer
Number of presets	1 or 2
Display	LCD with green backlighting
Height digits (mm)	LCD 9
Display details	- 999 999 → 999 999
Input characteristics	
Inputs	2 counter inputs 1 reset input, 1 locking input
Input modes	Dir: Directional AS: up/dn PP: phase
Input type	Voltage or solid state
High level	3.5 → 30 V $\overline{\text{DC}}$
Low level	0 → 2 V $\overline{\text{DC}}$
Relay output characteristics	
Changeover relay	✓
NO contact	Depending on version
Maximum current	3 A
Minimum current	30 mA
Maximum voltage	30 V $\overline{\text{DC}}$ / 250 V \sim
Min. voltage	5 V \sim
Response time	< 10 ms
Mechanical life (operations)	20 x 10 ⁶
Number of operations	1 x 10 ⁵
Output modes: maintained or pulsed	0.01 → 99.99 s

Dimensions (mm)

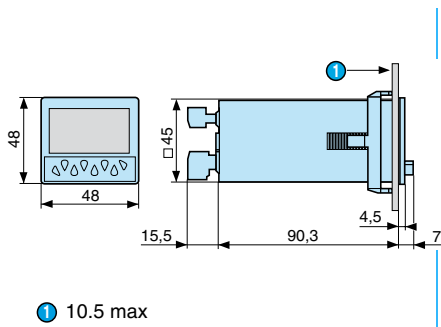

Panel cut-out

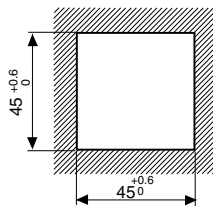

26546842 - Adaptor for 72 x 72 mm cut-out

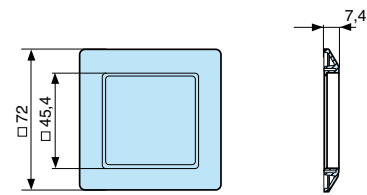

26546846 - Adaptor for 55 x 55 mm cut-out

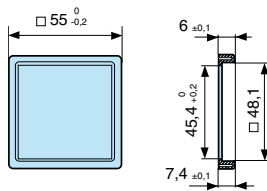

26546841 - DIN rail adaptor

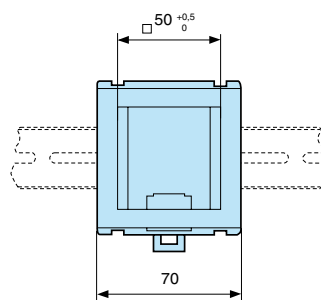
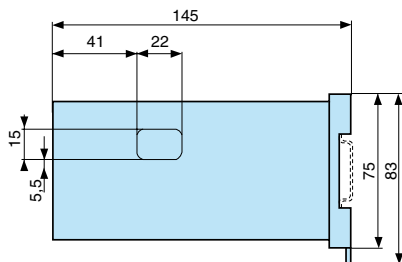

Connections

87629111

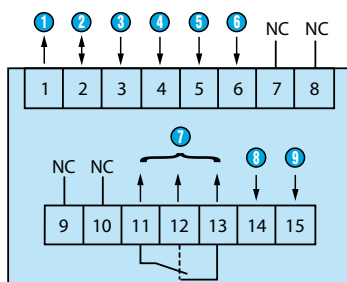

- ① Sensor voltage supply (* UB interconnected)
- ② GND (0 V₋₋₋)
- ③ INP A (signal A input)
- ④ INP B (signal B input)
- ⑤ Reset (Reset input)
- ⑥ Lock (locking switch input)
- ⑦ 11-12-13: Output 1
- ⑧ 14-15: Supply
- ⑨ Power supply - GND

87629113 / 114

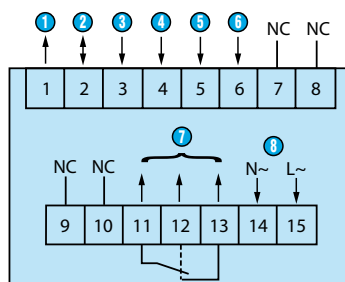

- ① Sensor voltage supply
- ② GND (0 V₋₋₋)
- ③ INP A (signal A input)
- ④ INP B (signal B input)
- ⑤ Reset (Reset input)
- ⑥ Lock (locking switch input)
- ⑦ 11-12-13: Output 1
- ⑧ 14-15: Supply

87629121

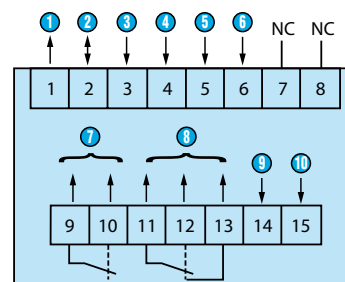

- ① Sensor voltage supply (* UB interconnected)
- ② GND (0 V₋₋₋)
- ③ INP A (signal A input)
- ④ INP B (signal B input)
- ⑤ Reset (Reset input)
- ⑥ Lock (locking switch input)
- ⑦ 9-10: Output 1
- ⑧ 11-12-13: Output 2
- ⑨ 14-15: Supply
- ⑩ Power supply - GND

87629123 / 124

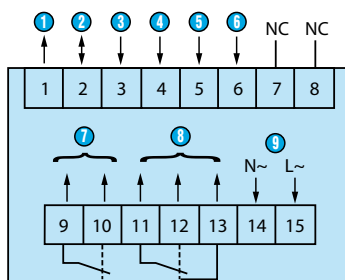

- ① Sensor voltage supply
- ② GND (0 V₋₋₋)
- ③ INP A (signal A input)
- ④ INP B (signal B input)
- ⑤ Reset (Reset input)
- ⑥ Lock (locking switch input)
- ⑦ 9-10: Output 1
- ⑧ 11-12-13: Output 2
- ⑨ 14-15: Supply

Applications

Programming diagram

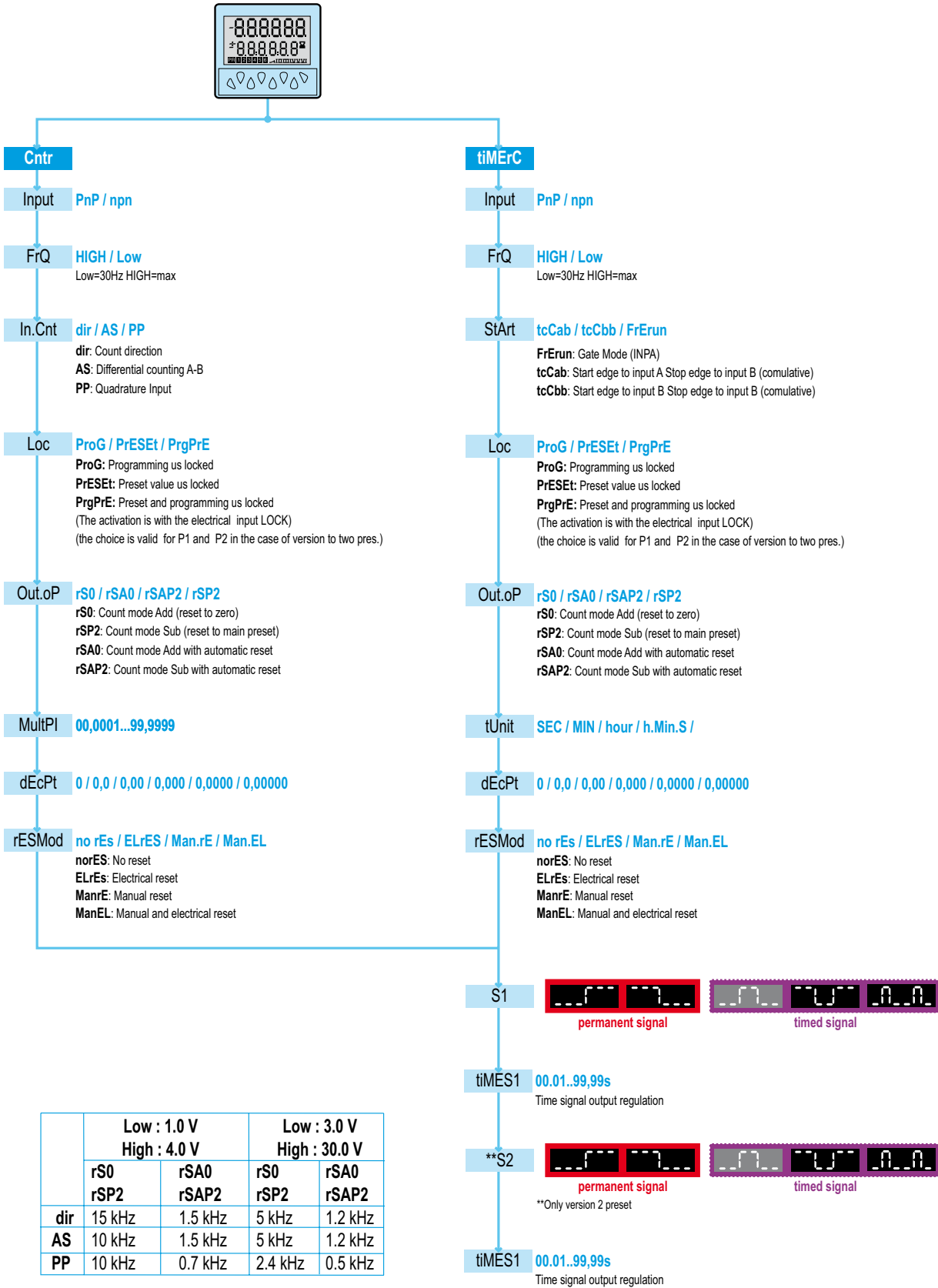

Curves

Counter: dir

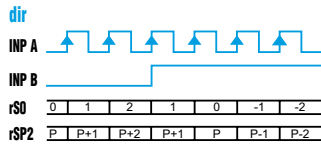

A 90° B
 Inp A: Counter input
 Counting on an edge
 Inp B: Reversal of direction
 rS0: Display 0 → Preset
 rSP2: Display Preset → 0

Counter: AS

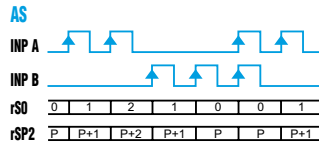

Inp A: Add. counter input 1
 Inp B: Sub. counter input 2
 rS0: Display 0 → Preset
 rSP2: Display Preset → 0

Counter: PP

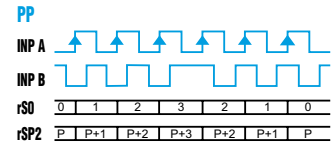

A 90° B
 Inp A: Counter input
 Counting on an edge
 Inp B: Reversal of direction
 rS0: Display 0 → Preset
 rSP2: Display Preset → 0

Chronometer: Start tcCAb

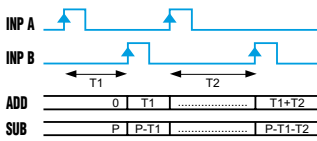

Inp A: On
 Inp B: Off
 Add: Display 0 → Preset
 Sub: Display Preset → 0

Chronometer: Start tcCbb

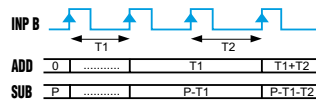

Inp A: No function
 Inp B: On/Off
 RS0/RSP2
 Add: Display 0 → Preset
 Sub: Display Preset → 0

Chronometer: Start FrErUn

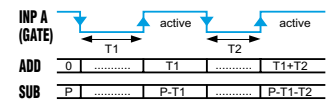

InpA: Gate
 Time measurement via InpA
 InpB: No function

Output operation 1: rS0

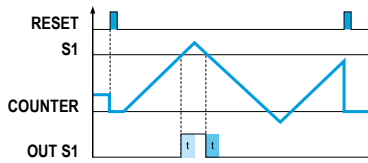

Output operation 1: rSA0

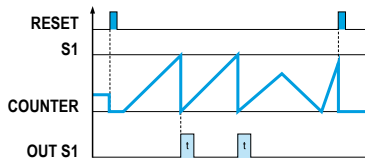

Output operation 1: rSP2

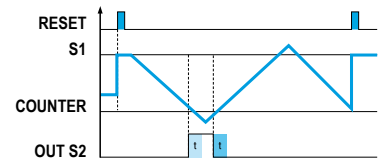

Output operation 1: rSAP2

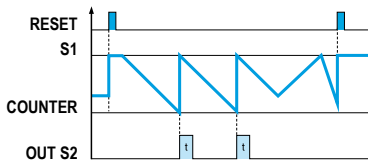

Output operation 2: rS0

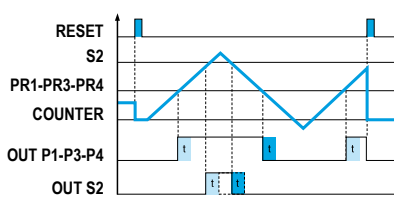

Output operation 2: rSA0

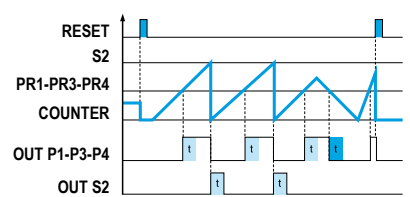

Output operation 2: rSP2

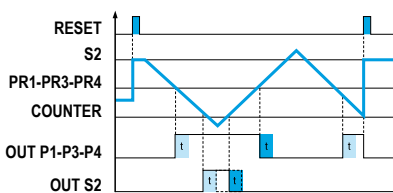

Output operation 2: rSAP2

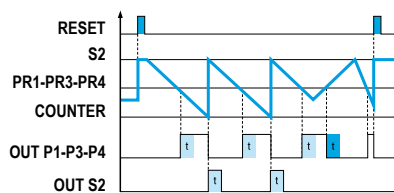

Crouzet Control, Technology and expertise, behind every project

- **Local** support for all industrial projects.
- A **multi-skilled** team.
- A sales presence in over **40 countries**.
- A Premium offer designed to ensure the **excellence** of products and services.
- **Eco-design integrated** in Crouzet's Offer Creation Process.
- Certifications: **ISO 9001, ISO 14001, OHSAS 18001**.
- Products which **comply with international standards** (UL, CSA, EC).
- A **dynamic R&D** department.



In addition to this catalogue, the **www.crouzet-control.com** website offers the latest tools, available as free downloads, including M3 Soft software, technical data sheets for each product and installation manuals.



To order:
Customer Service
Crouzet Control
Tel.: +33 (0) 475 802 102
customer.relation@crouzet.com



Electronic multifunction counters without preselection

→ Multifunction counter - LED 24 x 48 - CTR24L

- High brightness display: 6-digit LED, height 8 mm
- Maximum input frequency 50 k Hz
- Programmable multifunction: Counter/Tachometer/Chronometer
- Reset on panel or external with inhibition option
- Supply: 10 → 30 V_{DC}
- Easy to program
- Scaling factor (Counter - Tachometer)
- Decimal point (Counter - Tachometer)
- Timing range 0.001 s → 999.999 hrs (Chronometer)
- Impulses or time measured in hrs/min/sec and in real time (Chronometer)
- Accessories for 50 x 25 mm cut-out



Part numbers

Type	Functions	Code
CTR24L - 2511	Counter, Tachometer, Chronometer	87623570

Accessories

Description	Code
Adaptor for 50 x 25 mm cut-out - Fixed with screws	26546843
Adaptor for 50 x 25 mm cut-out - Fixed with clips	26546844
DIN rail adaptor	26546840
Clip-fixing kit (supplied with the product)	26546848

General characteristics

Environmental characteristics	
Consumption	10 → 30 V _{DC} max 55 mA with protection against polarity reversal
Connection by 5 screw terminals at rear of casing	✓
Connection capacity	1.5 mm ²
Fixed using bracket	✓
Degree of protection front face	IP 65
Data memory	EEPROM
Temperature limits use (°C)	-20 → +55
Temperature limits stored (°C)	-25 → +70
Dielectric strength	According to EN 61010-1: 2000 V/50 Hz/1 min
Conformity to standards	EN 61000-6-2 - EN 55011 class B
Altitude	2000 m
Certifications	UL - cULus (pending) - CE
Weight (g)	50
Operating characteristics	
Functions	Impulse counter, Tachometer, Chronometer
Display	6-digit LED
Height digits (mm)	8
Input characteristics	
Inputs	2 counter inputs, 1 reset input
High level	0 → 0.2 x U _b V _{DC}
Low level	0.6 x U _b → 30 V _{DC}
Cyclical ratio	Any (maximum frequency given for a cyclical ratio = 1/1) Schmitt trigger input
Polarity	NPN or PNP for all inputs (programming)
Minimum impulse duration for reset	5 ms
Frequency of filtered input	Filter active: 30 Hz Filter disabled: maximum frequency (programming)
Input impedance (kΩ)	Appr. 5
Impulse counter	
Display details	- 19 999 → 999 999
Elimination of non-significant zeros	✓

Counting input modes	Cnt.Dir → Counter input INPA and counter direction input INPB Up.dn → INPA INPB differential counting Up.up → Sum of INPA + INPB QuAd → Phase discriminator QuAd2 → Phase discriminator with doubling of impulses QuAd4 → Phase discriminator with quadrupling of impulses
Inputs INPA / INPB	Dynamic
Reset input (terminal 5)	Dynamic Reset input connected in parallel with the red SET/RESET button Sets the counter to the defined preset value
Reset to zero - Panel	If not locked during programming
Remise à zéro - Externe (borne 5)	If not locked during programming
Scale factor	1 → 99.9999
Scaling factor	1 → 99.9999
Decimal point	0 0.0 0.00 0.000
Maximum counting frequency	CntDir → 50 kHz UpDown → 25 kHz UpUp → 25 kHz Quad1 → 25 kHz Quad2 → 25 kHz Quad4 → 15 kHz
Tachometer	
Display details	0 → 999 999
Elimination of non-significant zeros	✓
Conversion time	1/s ou 1/min
Input INPA	Dynamic
Accuracy	< 0.1%
Measurement principle	< 38 Hz: measurement of period duration > 38 Hz: measurement with duration time base = 26.3 ms
Scale factor	1 → 99.9999
Scaling factor	1 → 99.9999
Decimal point	0 0.0 0.00 0.000
Maximum counting frequency	50 kHz
Chronometer	
Display details	0.001 s → 999 999 h
Elimination of non-significant zeros	✓
Functions	GatE.Lo → Time measurement if INPB is not active GatE.hi → Time measurement if INPB is active Inb.Inb → Time measurement on/off via the INPB edge InA.Inb → Measurement on via the INPA edge, measurement off via the INPB edge
Input INPA	Start
Input INPB	Start/Stop or Gate (depends on the input mode chosen)
Remise à zéro - Externe (borne 5)	If not locked during programming
Reset input (terminal 5)	Dynamic Reset input connected in parallel with the red SET/RESET button Sets the counter to the defined preset value
Reset to zero - Panel	If not locked during programming
Accuracy	< 50
Decimal point	0 0.0 0.00 0.000
Time ranges	0.001 s → 999 999 s 0.001 min → 99 999 min 0.001 h → 999 999 h 00 h 00 min 01 s → 99 h 59 min 59 s

Dimensions (mm)

CTR24L - 2511

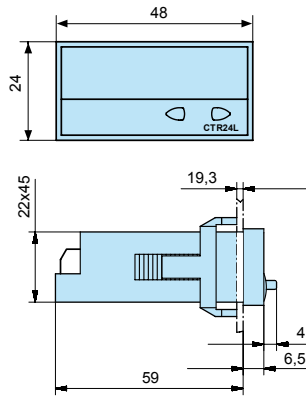

Fixing strip with clip-on yoke

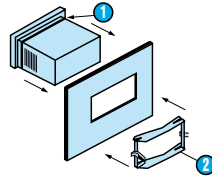

- ① Seal
- ② Fixing yoke

Panel cut-out

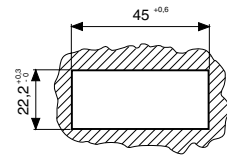

4 appliances

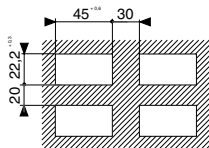

26546843 - Adaptor for 50 x 25 mm cut-out - Fixed with screws

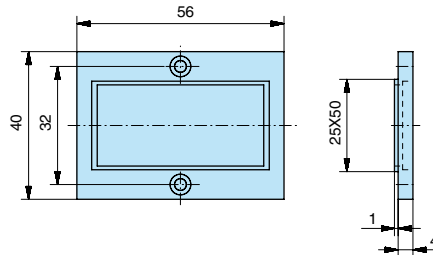

26546844 - Adaptor for 50 x 25 mm cut-out - Fixed with clips

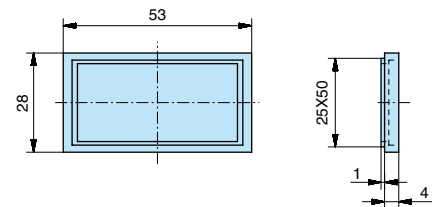

Accessory supplied with the counter

26546840 - DIN rail adaptor

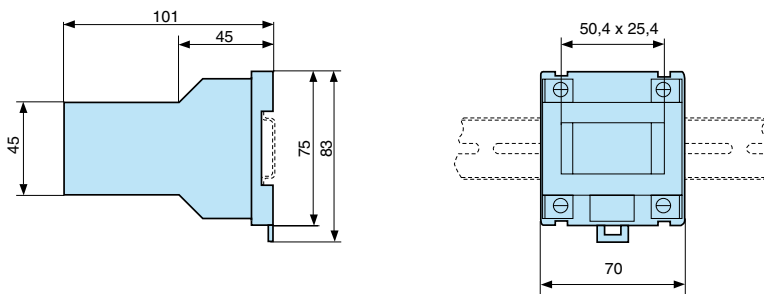

Connections

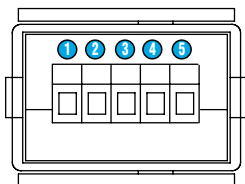

- ① Supply: 10 → 30 V $\overline{\text{---}}$
- ② Supply: GND (0 V $\overline{\text{---}}$)
- ③ INPA
- ④ INPB (NC in tachometer mode)
- ⑤ SET/RESET (NC in tachometer mode)

Applications

Programming diagram

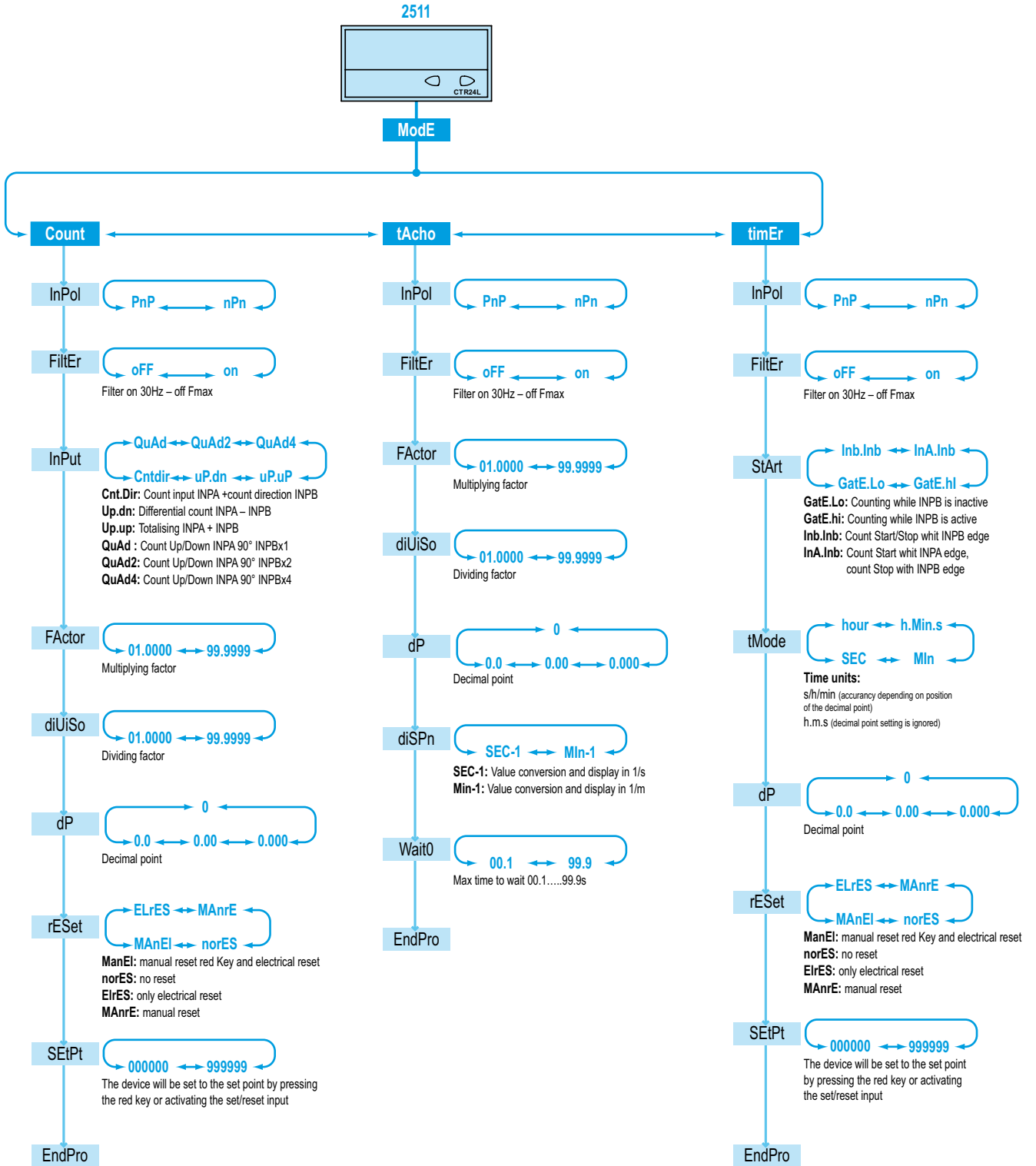

Count frequency:

DC power supply	24V	12V
Input level	Standard	
typ. low	2.5V	2.0V
typ. High	22.0V	10V
Fmax*	kHz	kHz
CntDir	50	20
UpDown	25	15
Up.up	25	15
Quad1	25	15
Quad2	25	15
Quad4	15	15

Count frequency:

DC power supply	24V	12V
Input level	Standard	
typ.low	2.5V	2.0V
typ. High	22.0V	10V
Fmax*	kHz	kHz
Tacho	50	20

Counting ranges:

Seconds	0,001s...999 999s
Minutes	0,001min...999 999min
Hours	0,001h...999 999h
h.min.s	00h00min01s...99h59min59s

Electronic multifunction counters without preselection

→ Multifunction counter with 2 totalizers - LED 24 x 48 - CTR24L

- High brightness display: 6-digit LED, height 8 mm
- Maximum input frequency 25 k Hz
- Counter with 2 separate totalizers, each with a dedicated input
- Reset on panel or external with inhibition option
- Supply: 10 → 30 V_{DC}
- Easy to program
- Scaling factor
- Decimal point
- Accessories for 50 x 25 mm cut-out



Part numbers

Type	Functions	Code
CTR24L - 2512	Counter with 2 separate totalizers	87623571

Accessories

Description	Code
Adaptor for 50 x 25 mm cut-out - Fixed with screws	26546843
Adaptor for 50 x 25 mm cut-out - Fixed with clips	26546844
DIN rail adaptor	26546840
Clip-fixing kit (supplied with the product)	26546848

General characteristics

Environmental characteristics	
Consumption	10 → 30 V _{DC} max 55 mA with protection against polarity reversal
Connection by 5 screw terminals at rear of casing	✓
Terminal capacity	1.5 mm ²
Fixed using bracket	✓
Degree of protection front face	IP 65
Data memory	EEPROM
Temperature limits use (°C)	-20 → +55
Temperature limits stored (°C)	-20 → +55
Breakdown voltage	EN 61010-1: 2000 V / 50 Hz / 1 min
Conformity to standards	EN 61000-6-2 - EN 55011 class B
Altitude	2000 m
Certifications	UL - cULus (pending) - CE
Weight (g)	50
Operating characteristics	
Functions	Counter with 2 separate totalizers
Display	6-digit LED
Height digits (mm)	8
Input characteristics	
Inputs	2 counter inputs, 1 reset input
Low level	0 → 0.2 x U _b V _{DC}
High level	0.6 x U _b → 30 V _{DC}
Cyclical ratio	Any (maximum frequency given for a cyclical ratio = 1/1) Schmitt trigger input
Polarity	NPN or PNP for all inputs (programming)
Minimum impulse duration for reset	5 ms
Frequency of filtered input	Filter active: 30 Hz Filter disabled: maximum frequency (programming)
Input impedance (kΩ)	Appr. 5
Impulse counter	
Display details	0 → 999 999
Display	When the buttons are pressed, the counter displays the following values: CntA → Value of counter A (INPA input) CntB → Value of counter B (INPB input) Asubb → Difference between A-B (INPA-INPB input) Addb → Addition of A+B (INPA+INPB input) AdlUb → Division of A/B (INPA/INPB input) Aprocb → Percentage (A-B) /A ((INPA-INPB) /INPA input)
Elimination of non-significant zeros	✓
Counting input modes	CntA → INPA input counting CntB → INPB input counting

Inputs INPA / INPB	Dynamic
Reset input (terminal 5)	Dynamic Reset input connected in parallel with the red SET/RESET button Sets the counter to the defined preset value - possible on both totalizers
Reset to zero - Panel	If not locked during programming
Reset to zero - External (borne 5)	If not locked during programming
Scale factor	1 → 99.9999 (separate for A and B)
Scaling factor	1 → 99.9999 (separate for A and B)
Decimal point	0 0.0 0.00 0.000
Maximum counting frequency	25 k Hz

Dimensions (mm)

CTR24L - 2512

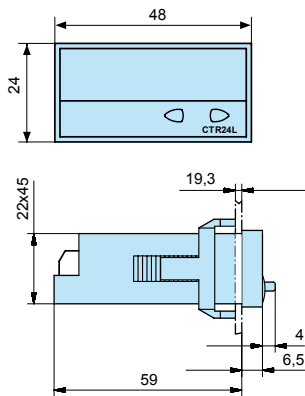

Fixing strip with clip-on yoke

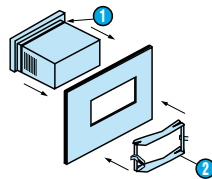

- ① Seal
- ② Fixing yoke

Panel cut-out

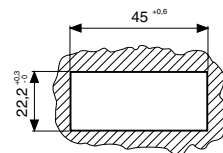

4 appliances

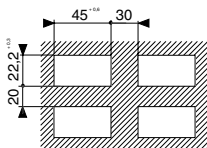

26546843 - Adaptor for 50 x 25 mm cut-out - Fixed with screws

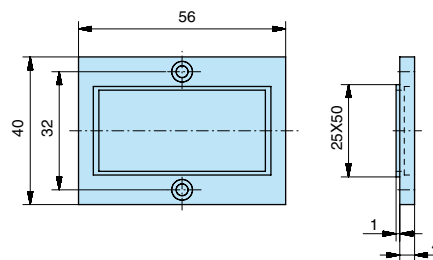

26546844 - Adaptor for 50 x 25 mm cut-out - Fixed with clips

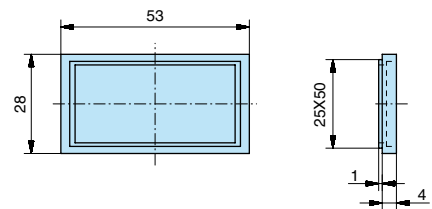

Accessory supplied with the counter

26546840 - DIN rail adaptor

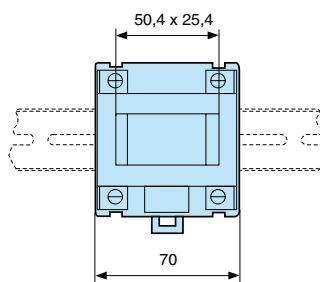
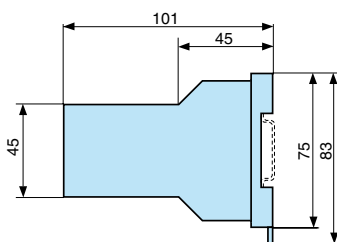

Connections

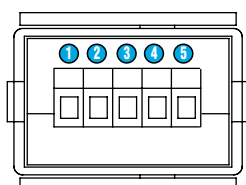

- ① Supply: 10 → 30 V $\overline{\text{=}}$
- ② Supply: GND (0 V $\overline{\text{=}}$)
- ③ INPA
- ④ INPB
- ⑤ SET/RESET

Applications

Programming diagram

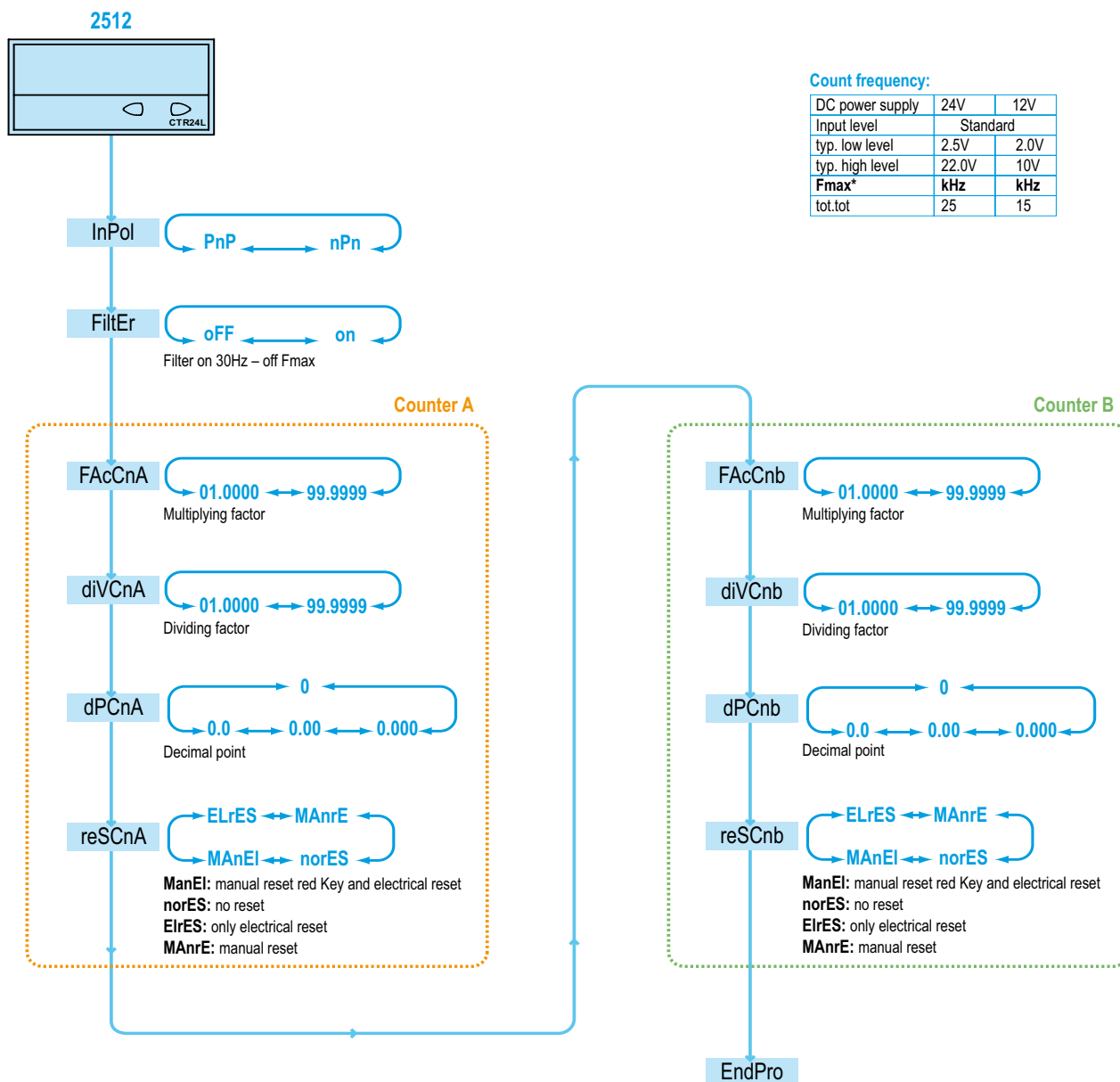

Count frequency:

DC power supply	24V	12V
Input level	Standard	
typ. low level	2.5V	2.0V
typ. high level	22.0V	10V
Fmax*	kHz	kHz
tot.tot	25	15

SELECTION OF THE DISPLAYED VALUE

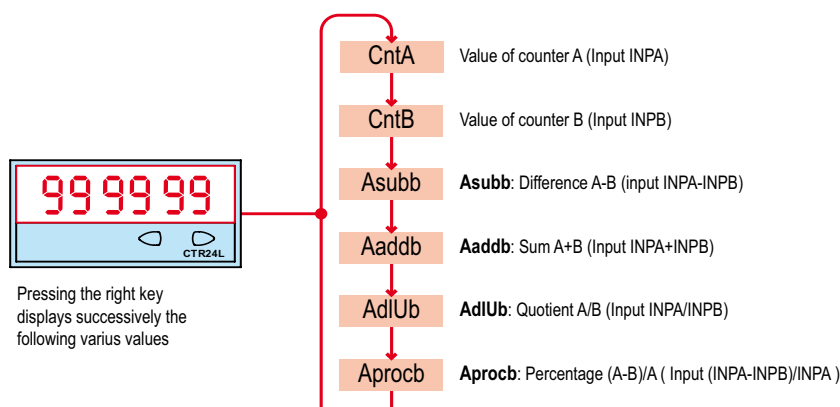

Crouzet Control, Technology and expertise, behind every project

- **Local** support for all industrial projects.
- A **multi-skilled** team.
- A sales presence in over **40 countries**.
- A Premium offer designed to ensure the **excellence** of products and services.
- **Eco-design integrated** in Crouzet's Offer Creation Process.
- Certifications: **ISO 9001, ISO 14001, OHSAS 18001**.
- Products which **comply with international standards** (UL, CSA, EC).
- A **dynamic R&D** department.



In addition to this catalogue, the **www.crouzet-control.com** website offers the latest tools, available as free downloads, including M3 Soft software, technical data sheets for each product and installation manuals.



To order:
Customer Service
Crouzet Control
Tel.: +33 (0) 475 802 102
customer.relation@crouzet.com



Electronic multifunction counters without preselection

→ Multifunction counter combining a totalizer and tachometer - LED 24 x 48 - CTR24L

- High brightness display: 6-digit LED, height 8 mm
- Maximum input frequency 30 k Hz
- Combined function: Position indicator counter and Tachometer
- Reset on panel
- Supply: 10 → 30 V_{DC}
- Easy to program
- Scaling factor (Counter - Tachometer)
- Decimal point (Counter - Tachometer)
- Accessories for 50 x 25 mm cut-out



Part numbers

Type	Functions	Code
CTR24L - 2513	Combined: Counter and Tachometer	87623572

Accessories

Description	Code
Adaptor for 50 x 25 mm cut-out - Fixed with screws	26546843
Adaptor for 50 x 25 mm cut-out - Fixed with clips	26546844
DIN rail adaptor	26546840
Clip-fixing kit (supplied with the product)	26546848

General characteristics

Environmental characteristics	
Consumption	10 → 30 V _{DC} max 55 mA with protection against polarity reversal
Connection by 5 screw terminals at rear of casing	✓
Terminal capacity	1.5 mm ²
Fixed using bracket	✓
Degree of protection front face	IP 65
Data memory	EEPROM
Temperature limits use (°C)	-20 → +55
Temperature limits stored (°C)	-25 → +70
Breakdown voltage	According to EN 61010-1: 2000 V / 50 Hz / 1 min
Conformity to standards	EN 61000-6-2 - EN 55011 class B
Altitude	2000 m
Certifications	UL - cULus (pending) - CE
Weight (g)	50
Operating characteristics	
Functions	Impulse counter and Tachometer
Display	6-digit LED
Height digits (mm)	8
Input characteristics	
Inputs	2 counter inputs, 1 tachometer input, 1 reset input
Low level	0 → 0.2 x U _b V _{DC}
High level	0.6 x U _b → 30 V _{DC}
Cyclical ratio	Any (maximum frequency given for a cyclical ratio = 1/1) Schmitt trigger input
Polarity	NPN or PNP for all inputs (programming)
Minimum impulse duration for reset	5 ms
Frequency of filtered input	Filter active: 30 Hz Filter disabled: maximum frequency (programming)
Input impedance (kΩ)	Appr. 5
Impulse counter	
Display details	- 19 999 → 999 999
Elimination of non-significant zeros	✓
Counting input modes	Cnt.Dir → Counter input INPA and counter direction input INPB Up.dn → INPA INPB differential counting Up.up → Sum of INPA + INPB QuAd → Phase discriminator QuAd2 → Phase discriminator with doubling of impulses QuAd4 → Phase discriminator with quadrupling of impulses
Inputs INPA / INPB	Dynamic
Reset to zero - Panel	If not locked during programming

Scale factor	1 → 99.9999
Scaling factor	1 → 99.9999
Decimal point	0 0.0 0.00 0.000
Maximum counting frequency	Combined Counter + Tachometer functions: CntDir → 30 kHz UpDown → 10 kHz UpUp → 10 kHz Quad1 → 15 kHz Quad2 → 15 kHz Quad4 → 10 kHz
Tachometer	
Display details	0 → 999 999
Elimination of non-significant zeros	✓
Conversion time	1/s or 1/min
Input INPC	Dynamic
Accuracy	< 0.1%
Measurement principle	< 38 Hz: measurement of period duration > 38 Hz: measurement with duration time base = 26.3 ms
Scale factor	1 → 99.9999
Scaling factor	1 → 99.9999
Decimal point	0 0.0 0.00 0.000
Maximum counting frequency	30 kHz

Dimensions (mm)

CTR24L - 2513

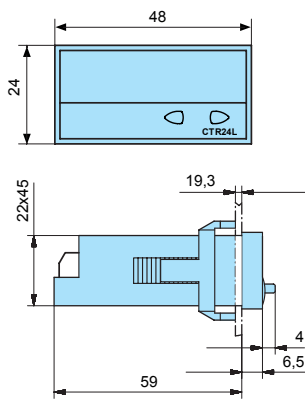

Fixing strip with clip-on yoke

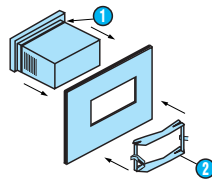

- 1 Seal
- 2 Fixing yoke

Panel cut-out

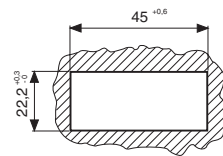

4 appliances

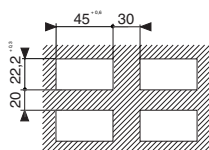

26546843 - Adaptor for 50 x 25 mm cut-out - Fixed with screws

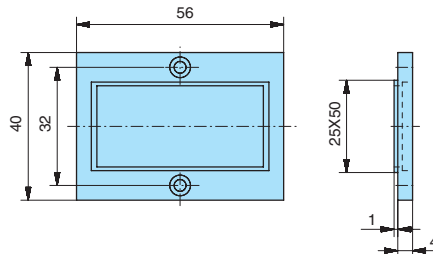

26546844 - Adaptor for 50 x 25 mm cut-out - Fixed with clips

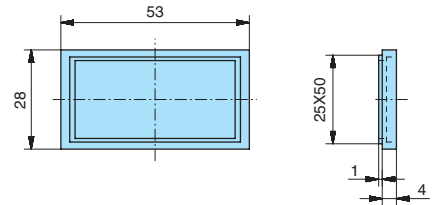

Accessory supplied with the counter

26546840 - DIN rail adaptor

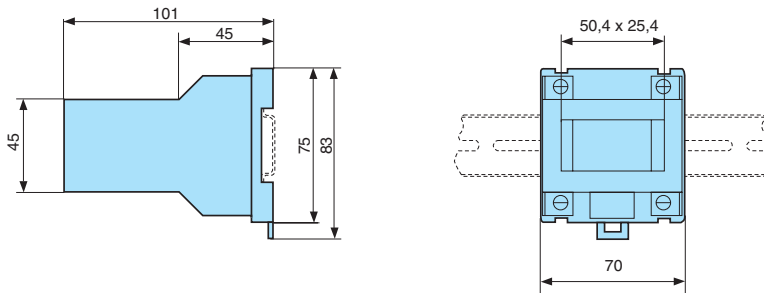

Connections

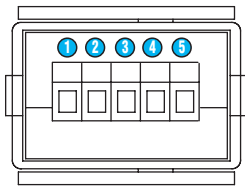

- ① Supply: 10 → 30 V $\overline{\text{---}}$
- ② Supply: GND (0 V $\overline{\text{---}}$)
- ③ INPA (Counter)
- ④ INPB (Counter)
- ⑤ INPC (Tachometer)

Applications

Programming diagram

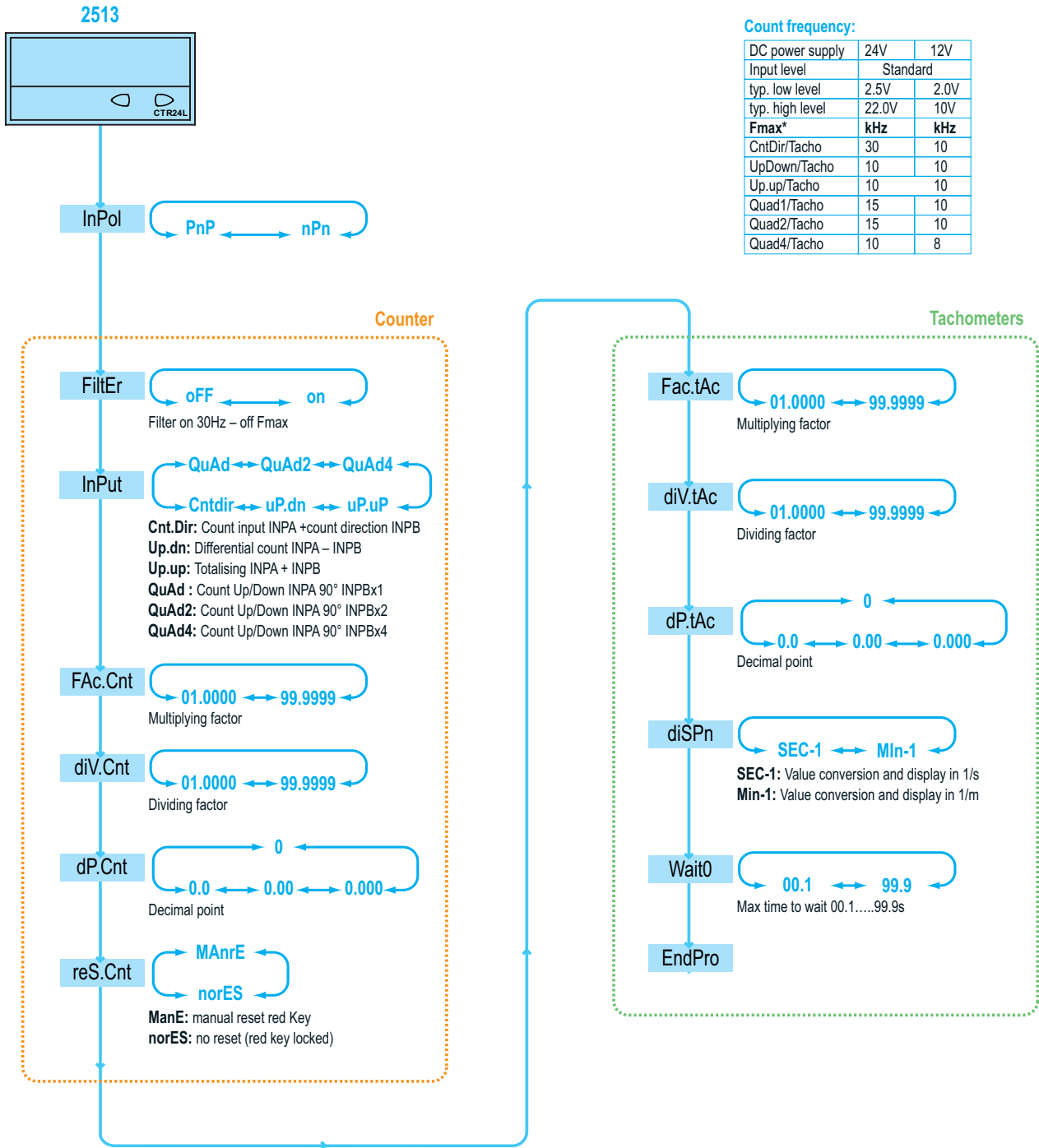

SELECTION OF THE DISPLAYED VALUE

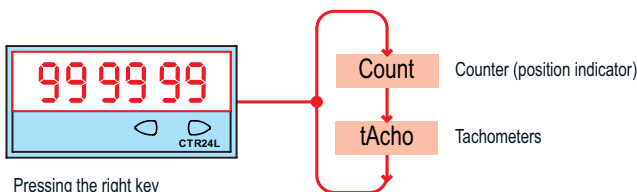

Pressing the right key displays successively the following various values

Electronic multifunction counters without preselection

→ Multifunction counter with 2 totalizers (total and partial function) with common input - LED 24 x 48 - CTR24L

- High brightness display: 6-digit LED, height 8 mm
- Maximum input frequency 50 k Hz
- Counter with 2 separate totalizers and a common input (INPA)
- Reset on panel or external with inhibition option
- Supply: 10 → 30 V_{DC}
- Easy to program
- Scaling factor
- Decimal point
- Accessories for 50 x 25 mm cut-out



Part numbers

Type	Functions	Code
CTR24L - 2514	Counter with 2 separate totalizers and a common input	87623573

Accessories

Description	Code
Adaptor for 50 x 25 mm cut-out - Fixed with screws	26546843
Adaptor for 50 x 25 mm cut-out - Fixed with clips	26546844
DIN rail adaptor	26546840
Clip-fixing kit (supplied with the product)	26546848

General characteristics

Environmental characteristics	
Consumption	10 → 30 V _{DC} max 55 mA with protection against polarity reversal
Connection by 5 screw terminals at rear of casing	✓
Terminal capacity	1.5 mm ²
Fixed using bracket	✓
Degree of protection front face	IP 65
Data memory	EEPROM
Temperature limits use (°C)	-20 → +55
Temperature limits stored (°C)	-25 → +70
Breakdown voltage	According to EN 61010-1: 2000 V / 50 Hz / 1 min
Conformity to standards	EN 61000-6-2 - EN 55011 class B
Altitude	2000 m
Certifications	UL - cULus (pending) - CE
Weight (g)	50
Operating characteristics	
Functions	Counter with 2 separate totalizers and a common input
Display	6-digit LED
Height digits (mm)	8
Input characteristics	
Inputs	1 counter input (INPA), 1 reset input
Low level	0 → 0.2 x U _b V _{DC}
High level	0.6 x U _b → 30 V _{DC}
Cyclical ratio	Any (maximum frequency given for a cyclical ratio = 1/1) Schmitt trigger input
Polarity	NPN or PNP for all inputs (programming)
Minimum impulse duration for reset	5 ms
Frequency of filtered input	Filter active: 30 Hz Filter disabled: maximum frequency (programming)
Input impedance (kΩ)	Appr. 5
Impulse counter (Partial - Totalizer)	
Display details	0 → 999 999
Display	When the buttons are pressed, the counter displays the following values: Total 1 Total 2
Elimination of non-significant zeros	✓
Counting input mode	INPA input counting
Input INPA	Dynamic
Reset input (terminal 5)	Dynamic Reset input connected in parallel with the red SET/RESET button

Reset to zero - Panel	If not locked during programming
Remise à zéro - Externe (borne 5)	If not locked during programming
Scale factor	1 → 99.9999 (separate for A and B)
Scaling factor	1 → 99.9999 (separate for A and B)
Decimal point	0 0.0 0.00 0.000
Maximum counting frequency	50 k Hz

Dimensions (mm)

CTR24L - 2514

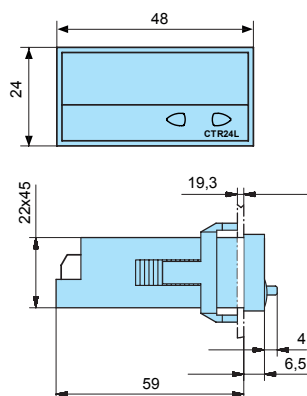

Fixing strip with clip-on yoke

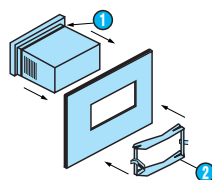

- ① Seal
- ② Fixing yoke

Panel cut-out

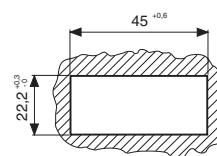

4 appliances

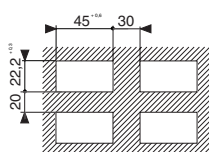

26546843 - Adaptor for 50 x 25 mm cut-out - Fixed with screws

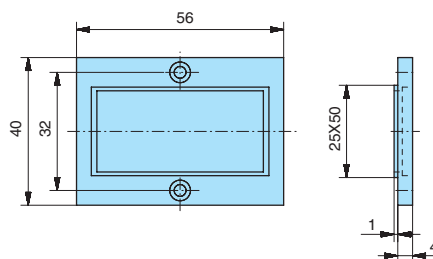

26546844 - Adaptor for 50 x 25 mm cut-out - Fixed with clips

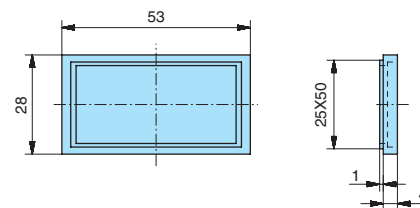

Accessory supplied with the counter

26546840 - DIN rail adaptor

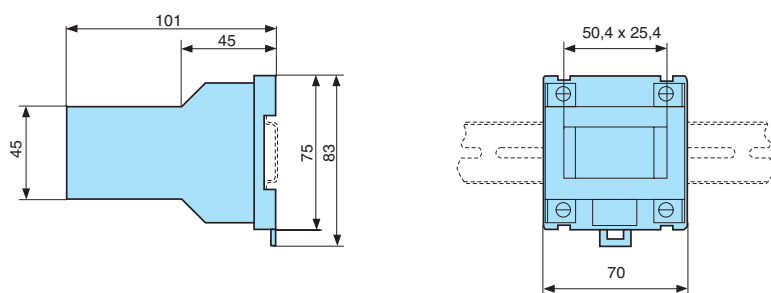

Connections

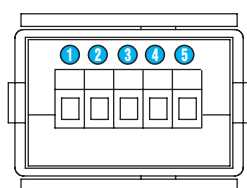

- ① Supply: 10 → 30 V $\overline{\text{---}}$
- ② Supply: GND (0 V $\overline{\text{---}}$)
- ③ INPA
- ④ NC
- ⑤ SET/RESET

Applications

Programming diagram

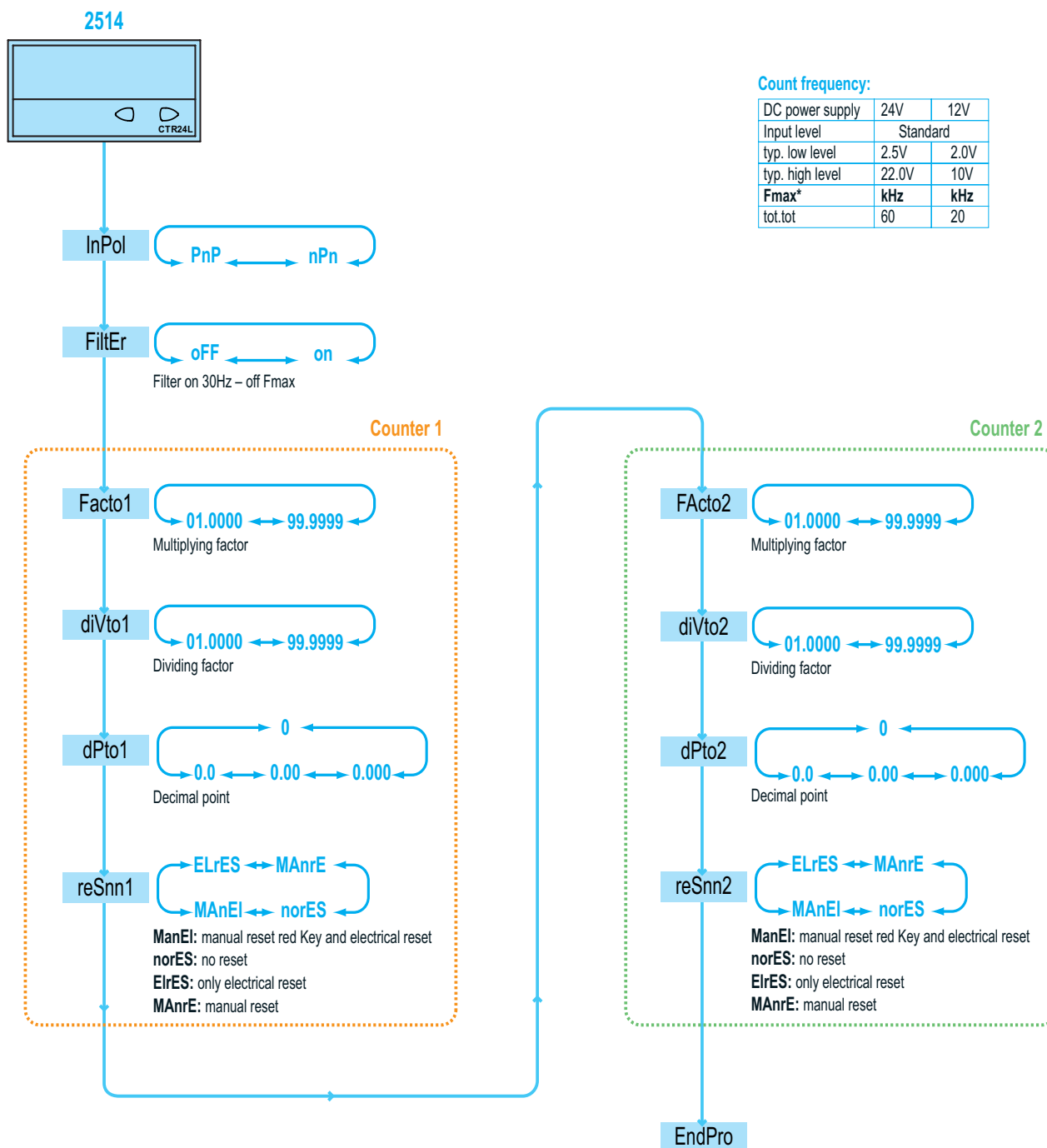

SELECTION OF THE DISPLAYED VALUE

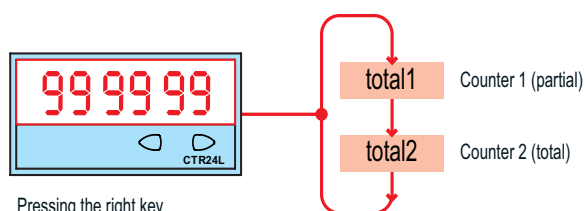

Pressing the right key displays successively the following various values

Crouzet Control, Technology and expertise, behind every project

- **Local** support for all industrial projects.
- A **multi-skilled** team.
- A sales presence in over **40 countries**.
- A Premium offer designed to ensure the **excellence** of products and services.
- **Eco-design integrated** in Crouzet's Offer Creation Process.
- Certifications: **ISO 9001, ISO 14001, OHSAS 18001**.
- Products which **comply with international standards** (UL, CSA, EC).
- A **dynamic R&D** department.



In addition to this catalogue, the **www.crouzet-control.com** website offers the latest tools, available as free downloads, including M3 Soft software, technical data sheets for each product and installation manuals.



To order:
Customer Service
Crouzet Control
Tel.: +33 (0) 475 802 102
customer.relation@crouzet.com



Electronic multifunction counters without preselection

→ "DUO" multifunction counter - LED 24 x 48 - CTR24L

- High brightness display: 6-digit LED, height 8 mm
- Maximum input frequency 50 kHz (in tot.tot function)
- Programmable dual functions: Counter + Tachometer/
Counter + Counter/Counter + Chronometer/
Chronometer + Chronometer
- Reset on panel or external with inhibition option
- Supply: 10 → 30 V_{DC}
- Easy to program
- Scaling factor (Counter - Tachometer)
- Decimal point (Counter - Tachometer - Chronometer)
- Timing range 0.001 s → 999.999 hrs (Chronometer)
- Impulses or time measured in hrs/min/sec and in real time (Chronometer)
- Accessories for 50 x 25 mm cut-out



Part numbers

Type	Functions	Code
CTR24L - 2515	DUO counter: Counter + Tachometer/Counter + Counter/Counter + Chronometer/Chronometer + Chronometer	87623574

Accessories

Description	Code
Adaptor for 50 x 25 mm cut-out - Fixed with screws	26546843
Adaptor for 50 x 25 mm cut-out - Fixed with clips	26546844
DIN rail adaptor	26546840
Clip-fixing kit (supplied with the product)	26546848

General characteristics

Environmental characteristics	
Consumption	10 → 30 V _{DC} max 55 mA with protection against polarity reversal
Connection by 5 screw terminals at rear of casing	✓
Connection capacity	1.5 mm ²
Fixed using bracket	✓
Degree of protection front face	IP 65
Data memory	EEPROM
Temperature limits use (°C)	-20 → +55
Temperature limits stored (°C)	-25 → +70
Breakdown voltage	According to EN 61010-1: 2000 V / 50 Hz / 1 min
Conformity to standards	EN 61000-6-2 - EN 55011 class B
Altitude	2000 m
Certifications	UL - cULus - CE
Weight (g)	50
Operating characteristics	
Functions	Counter + Tachometer/Counter + Counter/Counter + Chronometer/ Chronometer + Chronometer
Display	6-digit LED
Height digits (mm)	8
Input characteristics	
Inputs	2 counter inputs, 1 reset input
Low level	0 → 0.2 x U _b V _{DC}
High level	0.6 x U _b → 30 V _{DC}
Cyclical ratio	Any (maximum frequency given for a cyclical ratio = 1/1) Schmitt trigger input
Polarity	NPN or PNP for all inputs (programming)
Minimum impulse duration for reset	5 ms
Frequency of filtered input	Filter active: 30 Hz Filter disabled: maximum frequency (programming)
Input impedance (kΩ)	Appr. 5
Impulse counter	
Display details	0 → 999 999
Elimination of non-significant zeros	✓
Counting input modes	INPA input counting
Input INPA	Dynamic (uses the same INPA input as the counter)

Reset input (terminal 5)	Dynamic Reset input connected in parallel with the red SET/RESET button Sets the counter to the defined preset value
Reset to zero - Panel	If not locked during programming
Reset to zero - External (terminal 5)	If not locked during programming
Scale factor	1 → 99.9999
Scaling factor	1 → 99.9999
Decimal point	0 0.0 0.00 0.000
Maximum counting frequency	50 kHz
Tachometer	
Display details	0 → 999 999
Elimination of non-significant zeros	✓
Conversion time	1/s or 1/min
Input INPA	Dynamic (uses the same INPA input as the counter)
Accuracy	< 38 Hz: measurement of period duration > 38 Hz: measurement of duration time base = 26.3 ms
Measurement principle	< 0.1%
Scale factor	1 → 99.9999
Scaling factor	1 → 99.9999
Decimal point	0 0.0 0.00 0.000
Maximum counting frequency	35 kHz
Chronometer	
Display details	0.001 s → 999 999 h
Elimination of non-significant zeros	✓
Functions	In tot.tr function: GatE.Lo → Time measurement if INPB is not active GatE.hi → Time measurement if INPB is active Inb.Inb → Time measurement on/off via the INPB edge In tr.tr function: IGatE.Lo → Time measurement if INPB is not active GatE.hi → Time measurement if INPB is active Inb.Inb → Time measurement on/off via the INPB edge InA.Inb → Measurement on via the INPA edge, measurement off via the INPB edge
Input INPA	Start/Stop or Gate (depends on the input mode chosen)
Input INPB	Start/Stop or Gate (depends on the input mode chosen)
Reset input (terminal 5)	Dynamic Reset input connected in parallel with the red SET/RESET button Sets the counter to the defined preset value
Reset to zero - External (terminal 5)	If not locked during programming
Reset to zero - Panel	If not locked during programming
Accuracy	< 50
Decimal point	0 0.0 0.00 0.000
Time ranges	0.001 s → 999 999 s 0.001 min → 99 999 min 0.001 h → 999 999 h 00 h 00 min 01 s → 99 h 59 min 59 s
Maximum counting frequency	40 kHz

Dimensions (mm)

CTR24L - 2515

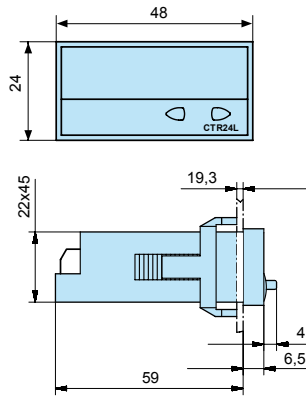

Fixing strip with clip-on yoke

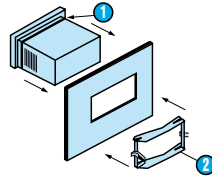

- ① Seal
- ② Fixing yoke

Panel cut-out

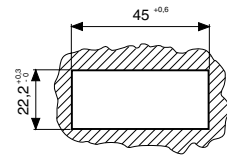

4 appliances

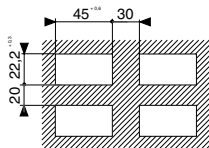

26546843 - Adaptor for 50 x 25 mm cut-out - Fixed with screws

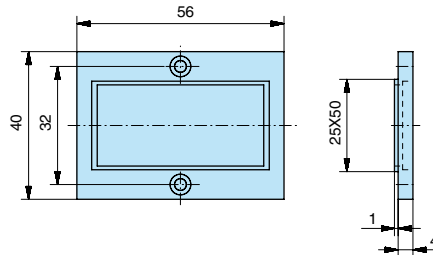

26546844 - Adaptor for 50 x 25 mm cut-out - Fixed with clips

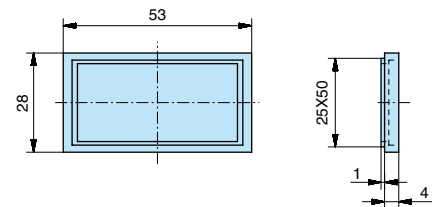

Accessory supplied with the counter

26546840 - DIN rail adaptor

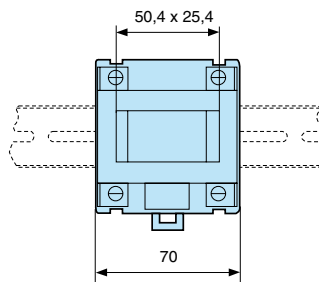
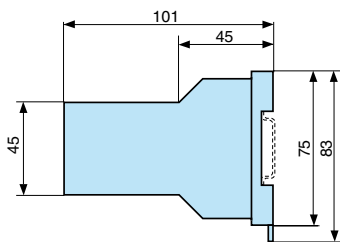

Connections

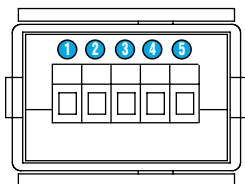

- ① Supply: 10 → 30 V $\overline{\text{---}}$
- ② Supply: GND (0 V $\overline{\text{---}}$)
- ③ INPA
- ④ INPB
- ⑤ SET/RESET

Applications

Programming diagram

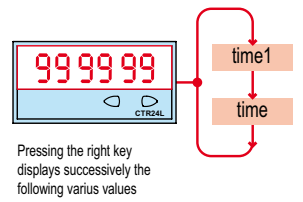
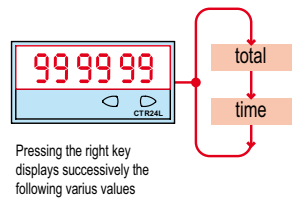
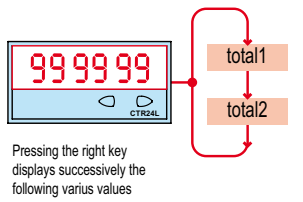
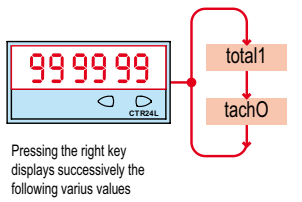
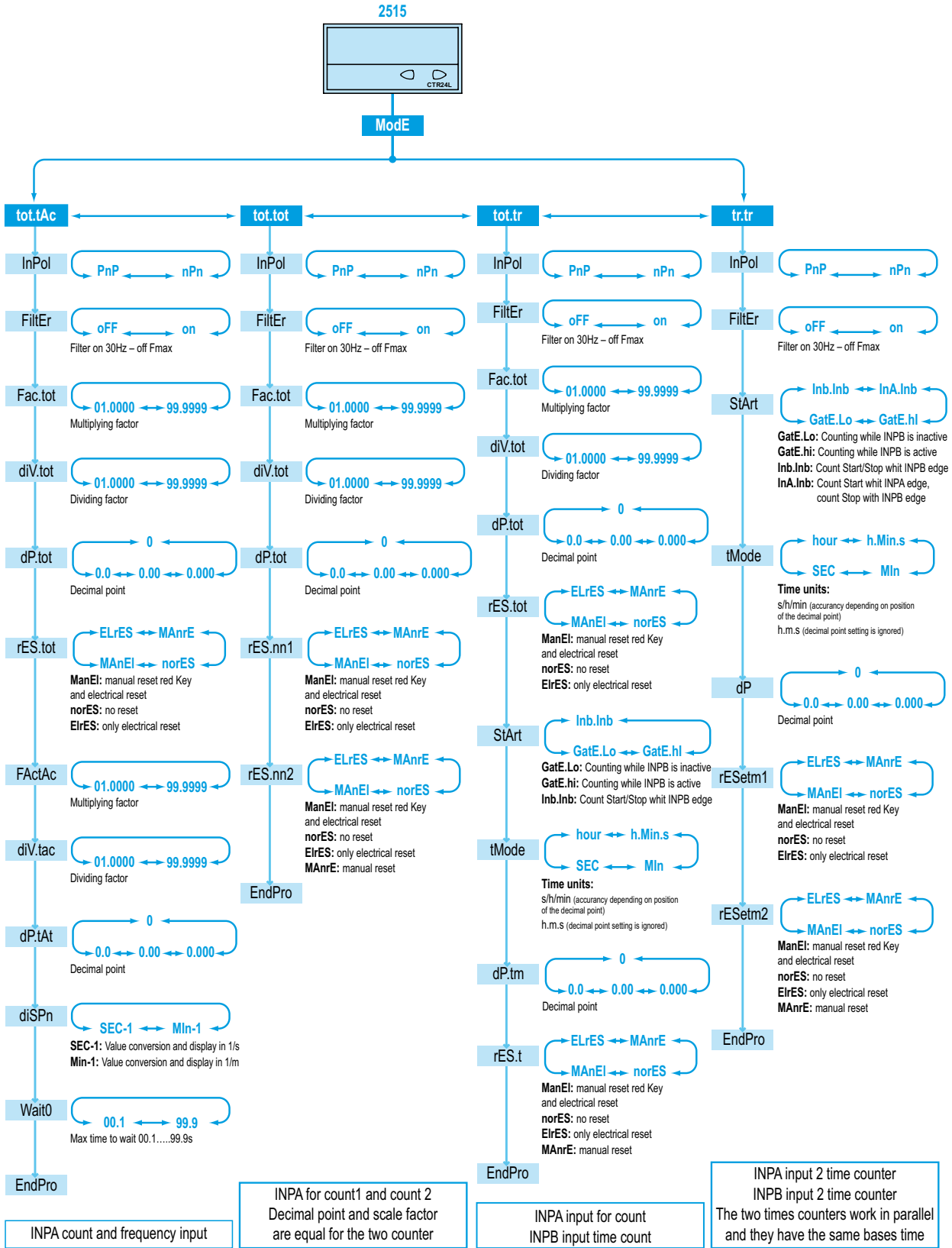

Electronic counters without preselection

→ Hour counters without preselection - LCD 24 x 48 - CTR24

- Display: 8 digits LCD, 8 mm height
- Built-in module for voltage inputs 10 → 260 V \sim (2224-2324)
- 4 timing ranges: 99.999.99 hrs - 99.999.59 hrs - 999.999.9 s - 9.999 hrs 59 min 59 s
- Powered by a lithium battery, service life 8 years
- Reset on panel or external with inhibition option
- Backlit model (2323-2333-2324)
- Accessories for 50 x 25 mm cut-out



Part numbers

Type	Type	Functions	Code
CTR24 non-backlit model	2223	Hour counter, solid state input PNP	87622161
	2233	Hour counter, solid state input NPN	87622162
	2224	Hour counter, voltage input	87622170
CTR24 model with orange backlighting	2323	Hour counter, solid state input PNP	87622181
	2333	Hour counter, solid state input NPN	87622182
	2324	Hour counter, voltage input	87622190

Accessories

Description	Code
Adaptor for 50 x 25 mm cut-out - Fixed with screws	26546843
Adaptor for 50 x 25 mm cut-out - Fixed with clips	26546844
DIN rail adaptor	26546840
Clip-fixing kit (supplied with the product)	26546848

General characteristics

Environmental characteristics	
Consumption	Backlighting: 24 V \sim \pm 20% 50 mA
Connection by 8 screw terminals at rear of casing	✓
Connection capacity	1.5 mm ²
Fixed using bracket	✓
Degree of protection front face	IP 65
Temperature limits use (°C)	-10 → +60
Temperature limits stored (°C)	-20 → +70
Breakdown voltage	According to EN 61010-1: 2000 V / 50 Hz / 1 min.
Conformity to standards	EN 61000-6-2 - EN 55011 class B
Altitude	2000 m
Certifications	UL - cULus (pending) - CE
Weight (g)	50
Operating characteristics	
Function	Hour counter
Display	8-digit LCD
Height digits (mm)	8
Time ranges	0 → 99 999.99 h 0 → 99 999.59 h 0 → 9 999 999.9 s 0 → 9 999 h 59 min 59 s
Time base: Crystal controlled (Accuracy \pm 100)	✓
Input 2223-2323	
One start/stop input by volt-free contact or NPN/PNP open-collector transistor (terminals 2-6)	✓
Low level	0 → 0.7 V \sim
High level	4 → 30 V \sim PNP
Min time closed	> 100 ms
Input impedance	100 k Ω PNP
Input 2233-2333	
One start/stop input by volt-free contact or NPN/PNP open-collector transistor (terminals 2-6)	✓
Low level	0 → 0.7 V \sim
High level	3 → 30 V \sim
Minimum time closed	> 100 ms
Input impedance	1 M Ω

Reset - External 2223-2323 & 2233-2333	
Volt-free contact or open collector (terminals 3-6)	✓
Minimum time closed	50 ms
Input 2224-2324	
One start/stop input Two voltage levels (terminals 3-6)	✓
Voltage - Terminals 1-2	10 → 260 V \sphericalangle
Input impedance	160 K Ω
Minimum pulse time \square	100 ms
Minimum pulse time \sim	100 ms
Low level	0 → 2 V \sphericalangle
High level	10 → 260 V \sphericalangle
Reset - External 2224-2324	
Voltage - Terminals 2-3	✓
Minimum pulse time	16 ms
Low level	0 → 2 V \sphericalangle
High level	10 → 260 V \sphericalangle
Reset to zero - Panel	
Reset via	Inhibited: Terminals 4-6 not connected Active: Terminals 4-6 connected
Supply	
1 lithium battery - Life (years)	8

Dimensions (mm)

CTR24

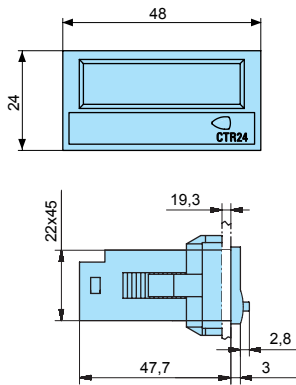

Fixing strip with clip-on yoke

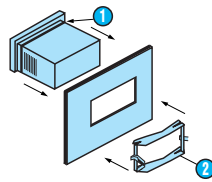

- 1 Seal
- 2 Fixing yoke

Panel cut-out

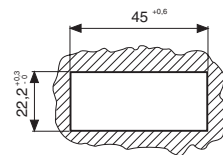

4 appliances

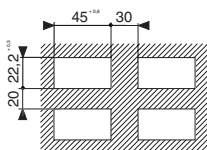

26546843 - Adaptor for 50 x 25 mm cut-out - Fixed with screws

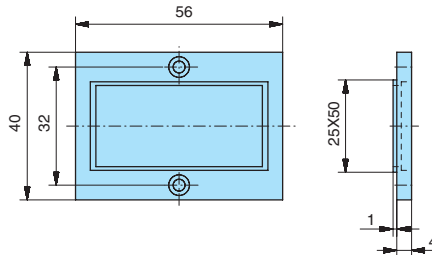

26546844 - Adaptor for 50 x 25 mm cut-out - Fixed with clips

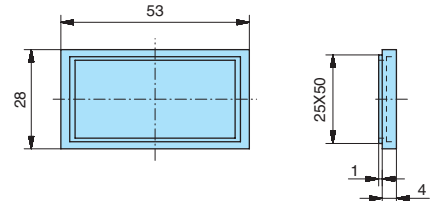

Accessory supplied with the counter

26546840 - DIN rail adaptor

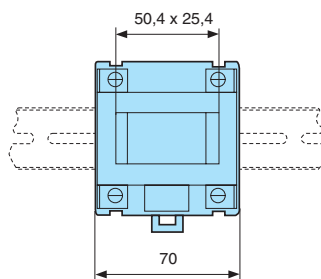
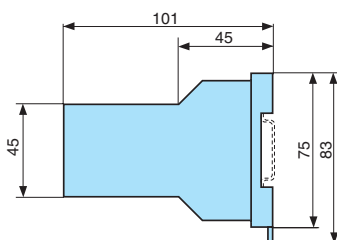

Connections

2223-2323

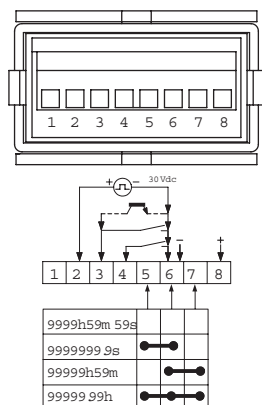

- ① NC
- ② Start/Stop input
- ③ Reset input 100 ms
- ④ Enable panel reset
- ⑤ Mode 1 (Time selection)
- ⑥ 0 V common/ (BL- only 23xx)
- ⑦ Mode 2 (Time selection)
- ⑧ Backlighting option + 24 V $\overline{\text{---}}$ (only 2323)

2223-2323

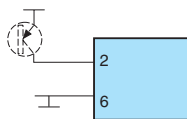

Start/Stop input
Transistor PNP

2223-2323

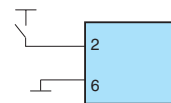

Start/Stop input PNP

2233-2333

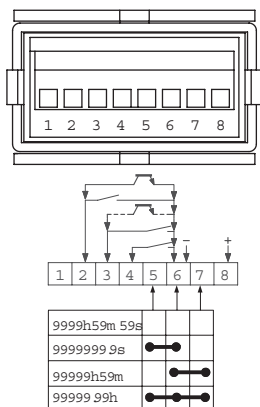

- ① NC
- ② Start/Stop input
- ③ Reset input 100 ms
- ④ Enable panel reset
- ⑤ Mode 1 (Time selection)
- ⑥ 0 V common/ (BL- only 23xx)
- ⑦ Mode 2 (Time selection)
- ⑧ Backlighting option + (only 2333)

2233-2333

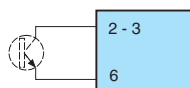

Start/Stop or reset input NPN - Transistor

2233-2333



Start/Stop or reset input PNP - Transistor

2233-2333

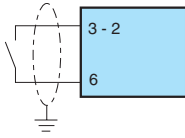

Start/Stop or reset input NPN - Transistor

2234-2324

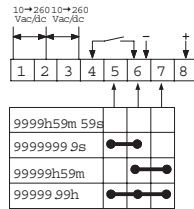
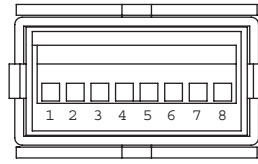

- 1 Start/Stop input
- 2 AC/DC common
- 3 Reset input
- 4 Enable panel reset
- 5 Mode 1 (Time selection)
- 6 0 V common/ (BL- only 23xx)
- 7 Mode 2 (Time selection)
- 8 Backlighting option + 24 V $\overline{\text{---}}$ (only 2324)

2234-2324

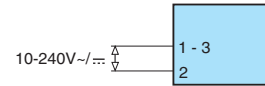

Start/Stop or reset input - Voltage

2234-2324

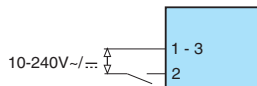

Start/Stop or reset input - Contact supplied with power

2234-2324

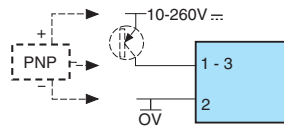

Start/Stop or reset input PNP Transistor or 3-wire PNP proximity sensor for leakage current detector < 1 mA

2234-2324

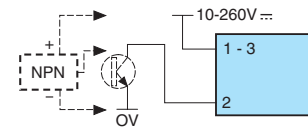

Start/Stop or reset input NPN Transistor or 3-wire NPN proximity sensor for leakage current detector < 1 mA

2234-2324

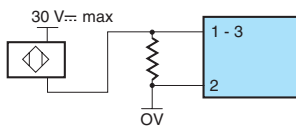

Start/Stop or reset input: 2-wire proximity sensor R=470 Ω /2 W for 2-wire leakage current detector \leq 1 mA

2234-2324

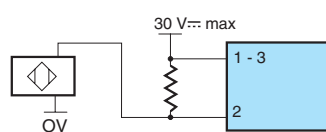

Start/Stop or reset input: 2-wire proximity sensor R=470 Ω /2 W for 2-wire leakage current detector \leq 1 mA

Electronic counters without preselection

→ Totalizers without preselection - LCD 24 x 48 - CTR24

- Display: 8-digit LCD, height 8 mm
- Powered by a lithium battery
- Counter inputs: solid state (4-30 V $\overline{\text{DC}}$) or voltage (10 \rightarrow 260 V \sim)
- Reset on panel or external with inhibition option
- Backlit model (2341-2351-2342)
- Counting directions can be selected with input (2241-2341/2251-2351)
- Accessories for 50 x 25 mm cut-out



Part numbers

Type	Type	Functions	Code
CTR24 non-backlit model	2241	Solid state input, lithium battery PNP/NPN	87622061
	2251	Solid state input, lithium battery NPN/NPN	87622062
	2242	Voltage input, lithium battery	87622070
CTR24 model with orange backlighting	2341	Solid state input, lithium battery PNP/NPN	87622081
	2351	Solid state input, lithium battery NPN/NPN	87622082
	2342	Voltage input, lithium battery	87622090

Accessories

Description	Code
Adaptor for 50 x 25 mm cut-out - Fixed with screws	26546843
Adaptor for 50 x 25 mm cut-out - Fixed with clips	26546844
DIN rail adaptor	26546840
Clip-fixing kit (supplied with the product)	26546848

General characteristics

Environmental characteristics	
Consumption	Backlighting: 24 V $\overline{\text{DC}}$ \pm 20% 50 mA
Connection by 8 screw terminals at rear of casing	✓
Connection capacity	1.5 mm ²
Fixed using bracket	✓
Degree of protection front face	IP 65
Temperature limits use (°C)	-10 \rightarrow +60
Temperature limits stored (°C)	-20 \rightarrow +70
Breakdown voltage	According to EN 61010-1: 2000 V / 50 Hz / 1 min
Conformity to standards	EN 61000-6-2 - EN 55011 class B
Altitude	2000 m
Certifications	UL - cULus (pending) - CE
Weight (g)	50
Operating characteristics	
Function	Impulse counter
Display	8-digit LCD
Height digits (mm)	8
Counting capacity	-9.999.999 \rightarrow 99.999.999 with elimination of zeros
Inputs 2241-2341	
1 slow counting input for contact closure on NPN open-collector transistor input (terminals 2-6)	✓
1 input for high speed counting signal from voltage level (terminals 1-6)	4 \rightarrow 30 V $\overline{\text{DC}}$
Low level	0 \rightarrow 0.7 V $\overline{\text{DC}}$
High level	4 \rightarrow 30 V $\overline{\text{DC}}$ PNP
High-speed counting	12 KHz max. 42 μ s PNP
Input impedance	100 K Ω PNP
Inputs 2251-2351	
1 slow counting input for contact closure on NPN open-collector transistor input (terminals 2-6)	✓
1 input for high speed counting signal from voltage level (terminals 1-6)	3 \rightarrow 30 V $\overline{\text{DC}}$
Low level	0 \rightarrow 0.7 V $\overline{\text{DC}}$
High level	3 \rightarrow 30 V $\overline{\text{DC}}$
High-speed counting	7 KHz max. 70 μ s NPN
Input impedance	1 M Ω

Reset - External 2241-2341 & 2251-2351	
Volt-free contact or open collector (terminals 3-6)	✓
Inputs 2242-2342	
1 input for slow counting 2 voltage levels	✓
Voltage - Terminals 1-2	10 → 260 V $\tilde{~}$
Input impedance (k Ω)	160
Slow counting	30 Hz
Minimum pulse time	16 ms
Low level	0 → 2 V $\tilde{~}$
High level	10 → 260 V $\tilde{~}$
Reset - External 2242-2342	
Voltage - Terminals 2-3	✓
Minimum pulse time	16 ms
Low level	0 → 2 V $\tilde{~}$
High level	10 → 260 V $\tilde{~}$
Reset to zero - Panel	
Reset via	Inhibited: Terminals 4-6 not connected Active: Terminals 4-6 connected
Supply	
1 lithium battery - Life (years)	8

Dimensions (mm)

CTR24

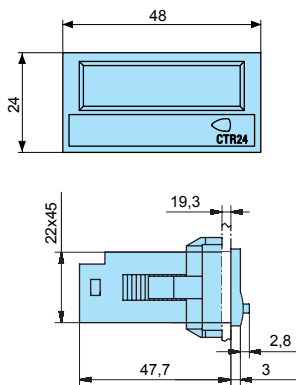

Fixing strip with clip-on yoke

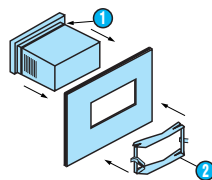

- ① Seal
- ② Fixing yoke

Panel cut-out

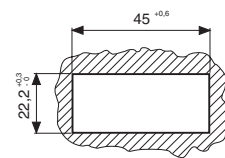

4 appliances

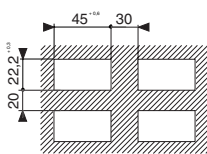

26546843 - Adaptor for 50 x 25 mm cut-out - Fixed with screws

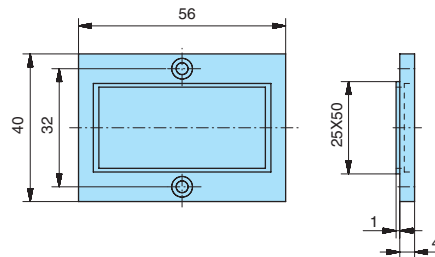

26546844 - Adaptor for 50 x 25 mm cut-out - Fixed with clips

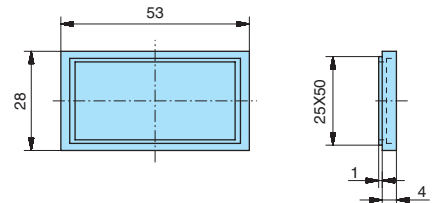

Accessory supplied with the counter

26546840 - DIN rail adaptor

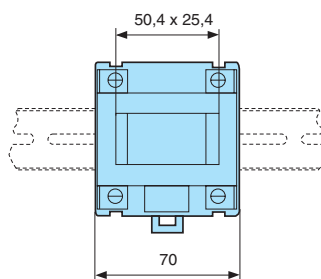
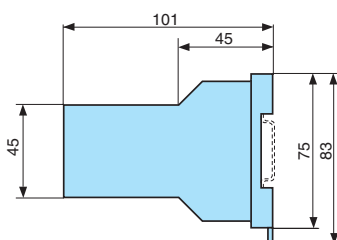

Connections

2241-2341

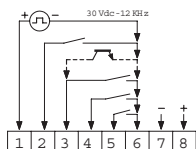
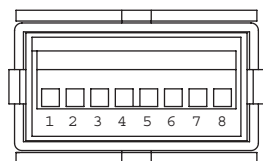

- 1 Fast count
- 2 Slow count
- 3 Reset input 12 ms
- 4 Enable panel reset
- 5 Mode count direction
- 6 0 V common/ (BL- only 23xx)
- 7 Backlighting option (only 2341)
- 8 Backlighting option + 24 V $\overline{\text{DC}}$ (only 2341)

2241-2341

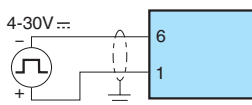

PNP fast count input - Voltage

2241-2341

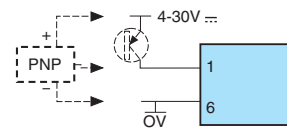

PNP fast count input Transistor or 3-wire PNP proximity sensor (for leakage current detector ≤ 1 mA)

2241-2341

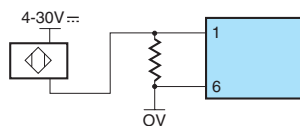

2-wire proximity sensor fast count input

2241-2341

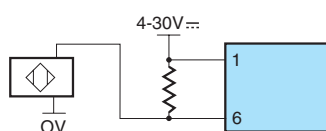

2-wire proximity sensor fast count input

2241-2341

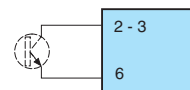

Slow count input (2) or reset input (3)

2241-2341

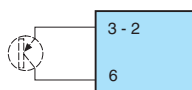

Slow count input (2) or reset input (3)

2241-2341

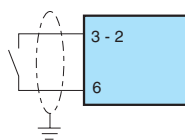

Slow count input (2) or reset input (3) - Contact not supplied with power

2251-2351

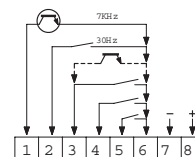
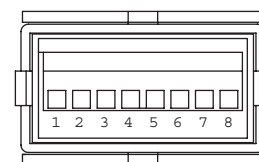

- 1 Fast count
- 2 Slow count
- 3 Reset input 12 ms
- 4 Enable panel reset
- 5 Mode count direction
- 6 0 V common/ (BL- only 23xx)
- 7 Backlighting option + (only 2351)
- 8 Backlighting option + 24 V $\overline{\text{DC}}$ (only 2351)

2251-2351

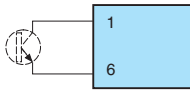

Fast count input NPN - Voltage

2251-2351

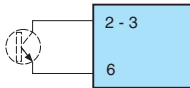

Slow count input (2) or reset input (3)

2251-2351

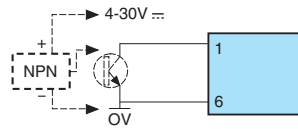

Fast count input NPN Transistor or 3-wire PNP proximity sensor (for leakage current detector ≤ 1 mA)

2251-2351

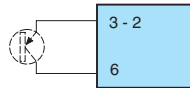

Slow count input (2) or reset input (3)

2251-2351

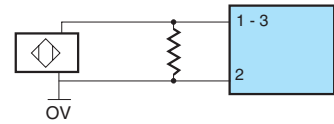

2-wire proximity sensor fast count input

2251-2351

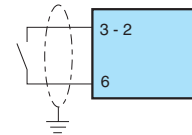

Slow count input (2) or reset input (3)
Contact not supplied with power

2242-2342

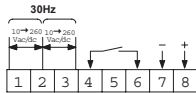
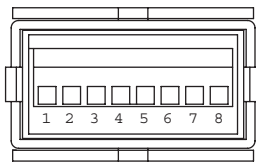

- 1 Fast count
- 2 AC/DC common
- 3 Reset input 12 ms
- 4 Enable panel reset
- 5 count direction
- 6 0 V common/ (BL- only 23xx)
- 7 Backlighting option - (only 2342)
- 8 Backlighting option + 24 V $\overline{\text{AC}}$ (only 2342)

2242-2342

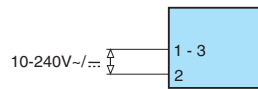

Counter or reset input - Voltage

2242-2342

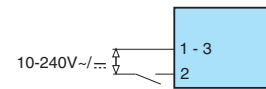

Counter or reset input -
Contact supplied with power

2242-2342

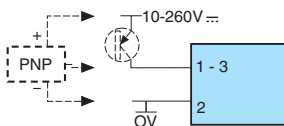

Counter or reset input PNP Transistor or 3-wire PNP proximity sensor (for leakage current detector < 1 mA)

2242-2342

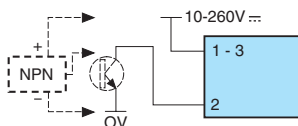

Counter or reset input NPN Transistor or 3-wire PNP proximity sensor (for leakage current detector < 1 mA)

2242-2342

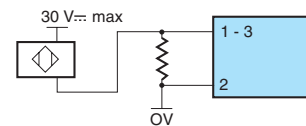

Start/Stop or reset input: 2-wire proximity sensor $R=470 \Omega/2$ W for 2-wire leakage current detector ≤ 1 mA

Electromechanical hour counters

→ Hour counters 48 X 48 - CHM48

- AC: capacity 100.000 hrs (99.999.99 hrs)
- DC: capacity 1.000.000 hrs (999.999.99 hrs)
- Operation indicator
- Panel mounted
- DIN rail mounted with connector base (accessory part number: 26546845)
- IP52
- Highly resistant to shocks and impacts
- Excellent visibility due to the large digit size



Part numbers

Type	Operating frequency (Hz)	Voltages	Code
CHM48	50	20 → 30 V~	99772710
	50	42 → 48 V~	99772711
	50	100 → 130 V~	99772712
	50	360 → 440 V~	99772713
	50	187 → 264 V~	99772714
	60	100 → 130 V~	99772715
	60	187 → 264 V~	99772716
	60	360 → 440 V~	99772717
	60	20 → 30 V~	99772718
	60	42 → 48 V~	99772719
	---	10 → 30 V---	99772810
	---	36 → 80 V---	99772811
	---	100 → 130 V---	99772812

Accessories

Description	Code
Adaptor for 72 x 72 mm cut-out	26546842
Adaptor for 55 x 55 mm cut-out	26546846
DIN rail adaptor	26546845

General characteristics

General characteristics	
Counting capacity	V~ : 99 999.99 V--- : 999.999.99
Reset to zero	Not included
Read accuracy	1/100 h
Height digits (mm)	4
Colour of hour numbers	White on a black background
Colour of decimal digits	Red on a black background
Accuracy	V~ : frequency + 30 ms V--- : < 0.003% (24 hrs)
Counting input mode	Addition
Operation indicator	V~ : rotating red lines V--- : 1/100 hr 1 digit in 36 s
Degree of protection front face	IP52
Mounting	Any
Temperature limits use (°C)	-15 → +50
Temperature limits stored (°C)	-40 → +80
Certifications	UL (pending)
Connections (panel mounted version)	Screw terminals - 6.35 mm Faston connectors
Connections (DIN rail mounted version)	Screw terminals with accessory 26 546 845
Connection capacity	2.5 mm ²
Consumption	V--- : 10 → 30 approx. 500 mW/100 → 130 approx. 750 mW/ V~ 50 Hz: 20 → 30 approx. 0.3 VA/42 → 48 approx. 0.25 VA/100 → 130 approx. 0.6 VA/187 → 264 approx. 1.2 VA/360 → 440 approx. 1.65 VA
Vibration resistance	50 m/s ² (10-500 Hz) IEC 68-2-6
Test voltage for AC models	2 000 V~ 50 Hz
Weight (g)	50

Dimensions (mm)

Panel mounted

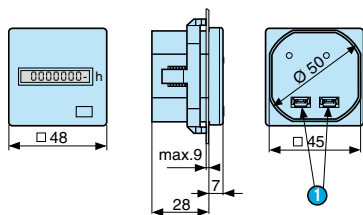

1 Screw terminals

26546846 - Adaptor for 55 x 55 mm cut-out

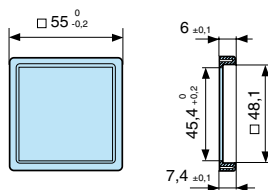

Panel cut-out

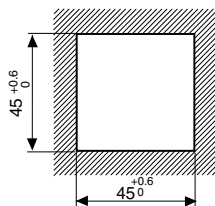

26546842 - Adaptor for 72 x 72 mm cut-out

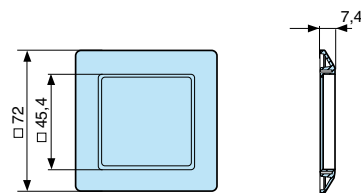

26546845 - DIN rail mounted

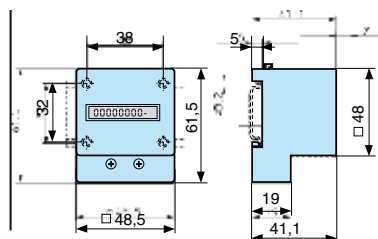

Electromechanical hour counters

→ Hour counters 24 X 48 - CHM24

- $V\sim$: capacity 100.000 hrs (99.999.99 hrs)
- $V\text{---}$: capacity 1.000.000 hrs (999.999.99 hrs)
- Operation indicator
- Panel mounted
- IP65 (with accessory 26546847)
- Highly resistant to shocks and impacts
- Compact size
- Excellent visibility due to the large digit size



Part numbers

Type	Operating frequency (Hz)	Voltages	Code
CHM24	50	20 → 30 $V\sim$	99782710
	50	100 → 130 $V\sim$	99782712
	50	187 → 264 $V\sim$	99782714
	60	100 → 130 $V\sim$	99782715
	60	187 → 264 $V\sim$	99782716
	60	20 → 30 $V\sim$	99782718
	$V\text{---}$	10 → 30 $V\text{---}$	99782810

Accessories

Description	Code
Set of seals	26546847
Adaptor for 50 x 25 mm cut-out - Fixed with screws	26546843
Adaptor for 50 x 25 mm cut-out - Fixed with clips	26546844

General characteristics

General characteristics	
Counting capacity	$V\sim$: 99.999.99 $V\text{---}$: 999.999.99
Reset to zero	Not included
Read accuracy	1/100 h
Height digits (mm)	4
Colour of hour numbers	White on a black background
Colour of decimal digits	Red on a black background
Accuracy	$V\sim$: frequency + 30 ms $V\text{---}$: < 0.003% (24 hrs)
Counting input mode	Addition
Operation indicator	$V\sim$: rotating red lines/DC: 1/100 hr 1 digit in 36 s
Protection rating	IP52 or IP65 with accessory (26546847)
Mounting position	Any
Temperature limits use (°C)	-10 → +50
Temperature limits stored (°C)	-40 → +80
Certifications	CE - UL (pending)
Connections (panel mounted version)	Screw terminals - 6.35 mm Faston connectors
Tightening torque (Nm)	0.8
Connection capacity	2.5 mm ²
Consumption	$V\text{---}$: 10 → 30 approx. 500 mW/100 → 130 approx. 750 mW/ $V\sim$ 50 Hz: 20 → 30 approx. 0.3 VA/100 → 130 approx. 0.6 VA/187 → 264 approx. 1.2 VA
Vibration resistance	50 m/s ² (10-500Hz) IEC 68-2-6
Test voltage for AC models	2 000 $V\sim$ 50 Hz
Weight (g)	50

Dimensions (mm)

Panel cut-out

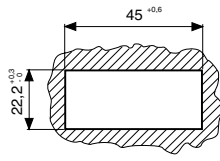

26546843 - Adaptor for cut-out

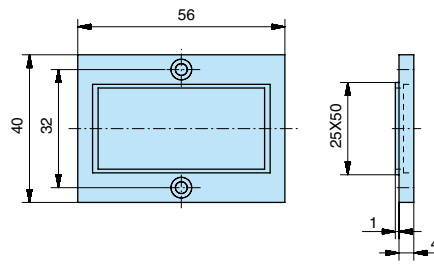

26546844 - Adaptor for cut-out

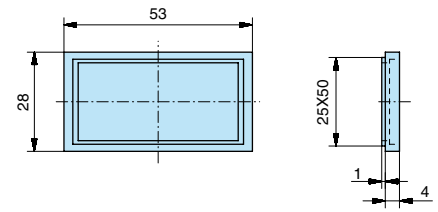

CHM24

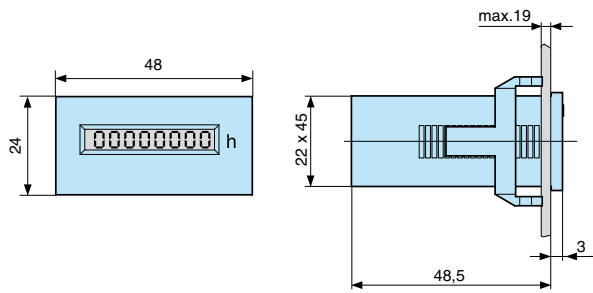

Electromechanical hour counters

→ Hour counters 15 X 32 - CHM15

- Capacity 100.000 hrs (99.999.99 hrs)
- Wide range of voltages: 4.5 → 35 V $\overline{\text{=}}$
- Panel mounted
- IP65
- Highly resistant to shocks and impacts
- Compact size
- Excellent visibility thanks to the large digit size



Part numbers

Type	Operating frequency (Hz)	Voltages	Code
CHM15	$\overline{\text{=}}$	4.5 → 35 V $\overline{\text{=}}$	99792810

General characteristics

General characteristics	
Counting capacity	99.999.99
Reset to zero	Not included
Read accuracy	1/100 h
Height digits (mm)	4
Colour of hour numbers	White on a black background
Colour of decimal digits	Red on a black background
Accuracy	V $\overline{\text{=}}$: < 0.003% (24 hrs, 25°C)
Counting input mode	Addition
Degree of protection front face	IP65
Mounting position	Horizontal readout of digits
Temperature limits use (°C)	-10 → +60
Temperature limits stored (°C)	-40 → +80
Certifications	CE - UL (pending)
Connections (panel mounted version)	Flying leads: 150 mm
Consumption	5 V $\overline{\text{=}}$ approx. 82 mW/12 V $\overline{\text{=}}$ approx. 135 mW/24 V $\overline{\text{=}}$ approx. 135 mW/ max 170 mW
Vibration resistance	50 m/s ² (10-500 Hz) IEC 68-2-6
Test voltage for AC models	2 000 V \sim 50 Hz
Weight (g)	20

Dimensions (mm)

Panel cut-out

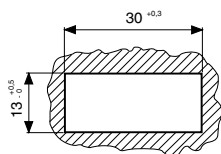

CHM15

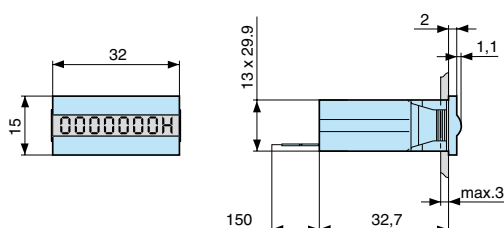

Electromechanical hour counters

→ DIN rail mounting hour counters - CHMDR

- Width equivalent to 2 modules
- Capacity 100.000 hrs (99.999.99 hrs)
- Extended temperature range: -10 → +70°C (~ version)
- DIN rail mounted according to EN 50022
- IP65 on panel
- Highly resistant to shocks and impacts
- Colour: RAL 7035 grey
- Screw terminals



Part numbers

Type	Operating frequency (Hz)	Voltages	Code
CHMDR	50	24 V~	99793710
	50	115 V~	99793712
	50	230 V~	99793714
	---	10 → 27 V---	99793810

Accessories

General characteristics

General characteristics	
Counting capacity	99.999.99
Reset to zero	Not included
Read accuracy	1/100 h
Height digits (mm)	3.5
Colour of hour numbers	White on a black background
Colour of decimal digits	Black on a white background
Accuracy	V~ / V--- : < 0.01% (24 hrs)
Counting input mode	Addition
Degree of protection front face	IP 65
Tolerance	V~ ± 10%
Temperature limits use (°C)	V~ : -10 → +70 V--- : -10 → +50
Temperature limits stored (°C)	-40 → +80
Certifications	CE
Connection	Screw terminals
Consumption	V~ : approx. 2.5 VA V--- : approx. 1 W
Vibration resistance	1G (10-500 Hz)
Test voltage for AC models	2 000 V~ 50 Hz
Weight (g)	60

Dimensions (mm)

CHMDR

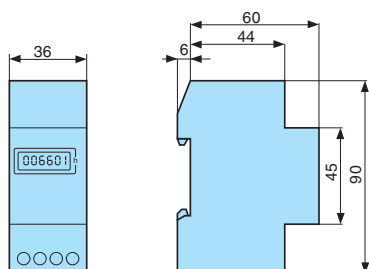

Dual-function electromechanical counters

→ Dual-function counter (hour counter and watt-hour meter) 48 x 48 - CEM48

- Dual-function counter (hour counter and watt-hour meter)
- Capacity 100.000 hrs (99.999.99 hrs)
- Remote readout via SO output
- Panel mounted
- IP 65
- Excellent visibility due to the large digit size



Part numbers

Type	Designation	Operating frequency (Hz)	Voltages	Code
CEM48	Single-phase (max. 16 A)	50 / 60	115 V~	99780712
	Single-phase (max. 16 A)	50 / 60	230 V~	99780714

Accessories

Description	Code
Adaptor for 72 x 72 mm cut-out	26546842
Adaptor for 55 x 55 mm cut-out	26546846
DIN rail adaptor	26546841

General characteristics

General characteristics	
Counting capacity	99.999.9 hrs/99.999.9 kWh
Display by LED	LED backlight: the counter is powered up LED flashing: the energy is being measured
Reset to zero	Not included
Read accuracy	1/10 h
Height digits (mm)	4
Colour of hour numbers	White on a black background
Colour of decimal digits	Red on a black background
Accuracy	Hour counter: ± 2% Watt-hour meter: Class B (1%)
Current	I _{max} : 16 A Current limits between 20 mA and 16 A Use for current > 20 mA
Degree of protection front face	IP65
Mounting	Any
Temperature limits use (°C)	- 20 → +55
Temperature limits stored (°C)	- 25 → +65
Certifications	CE
Connection	Screw terminals
Connection capacity	2.5 mm ²
Output signal	Watt-hour meter: 10 impulses/hr, 5 → 30 V _{DC} , I _{max} : 20 mA Hour counter: 1000 impulses/kWh, 5 → 30 V _{DC} , I _{max} : 20 mA
Standards	EN 50470-1, EN 50470-3
Test voltage for AC models	2 000 V~ 50 Hz
Weight (g)	83

Dimensions (mm)

Panel mounted

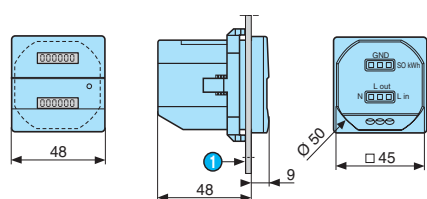

① 9 max.

Panel cut-out

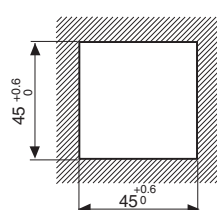

26546842 - Adaptor for 72 x 72 mm cut-out

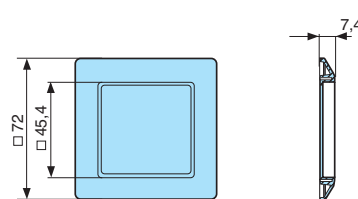

26546846 - Adaptor for 55 x 55 mm cut-out

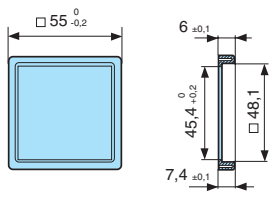

26546841 - DIN rail adaptor

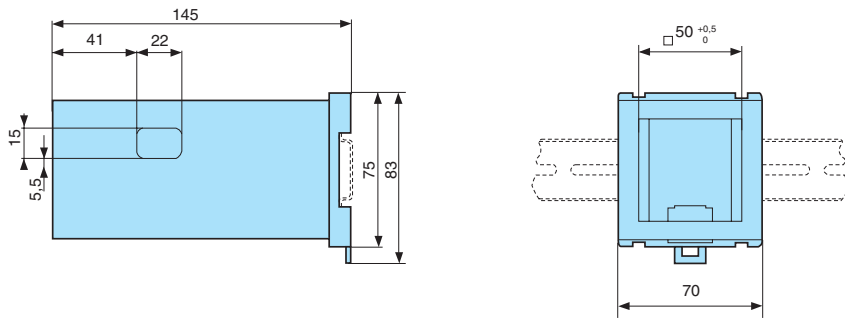

Connections

CEM48

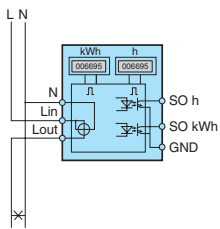

Dual-function electromechanical counters

→ Dual-function counters (hour counter and impulse counter) 48 x 48 - CMM48

- Dual-function counter (hour counter and impulse counter)
- $V\sim$: capacity 100.000 hrs (99.999.99 hrs)
- $V\text{---}$: capacity 1.000.000 hrs (999.999.99 hrs)
- Operation indicator
- Panel mounted
- IP52
- Highly resistant to shocks and impacts
- Excellent visibility thanks to the large digit size



Part numbers

Type	Operating frequency (Hz)	Voltages	Code
CMM48	50	20 → 30 $V\sim$	99779710
	50	100 → 130 $V\sim$	99779712
	50	187 → 264 $V\sim$	99779714
	60	20 → 30 $V\sim$	99779718
	60	100 → 130 $V\sim$	99779715
	60	187 → 264 $V\sim$	99779716
	$V\text{---}$	10 → 30 $V\text{---}$	99779810

Accessories

Description	Code
Adaptor for 72 x 72 mm cut-out	26546842
Adaptor for 55 x 55 mm cut-out	26546846

General characteristics

General characteristics	
Counting capacity	$V\sim$: 99.999.99 hrs $V\text{---}$: 999.999.99 hrs
Reset to zero	Not included
Read accuracy	1/100 h
Height digits (mm)	4
Colour of hour numbers	White on a black background
Colour of decimal digits	Red on a black background
Accuracy	$V\sim$: frequency + 30 ms $V\text{---}$: < 0.003% (24 hrs)
Counting input mode	Addition
Operation indicator	$V\sim$: rotating red lines $V\text{---}$: 1/100 hr 1 digit in 36 s
Degree of protection front face	IP52
Mounting position	Any
Temperature limits use (°C)	-15 → +50
Temperature limits stored (°C)	-40 → +80
Certifications	CE - UL (pending)
Connections (panel mounted version)	Screw terminals - 6.35 mm Faston connectors
Connection capacity	2.5 mm ²
Consumption	$V\text{---}$: 10 → 30 approx. 1 W $V\sim$ 50 Hz: 20 → 30 approx. 0.53 VA 100 → 130 approx. 1.43 VA/187 → 264 approx. 3 VA
Vibration resistance	50 m/s ² (10-500 Hz) IEC 68-2-6
Test voltage for AC models	2 000 $V\sim$ 50 Hz
Weight (g)	65

Dimensions (mm)

Panel mounted

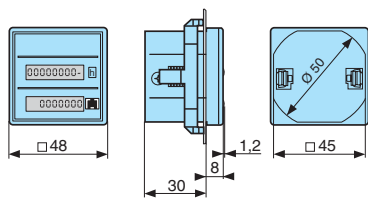

Panel cut-out

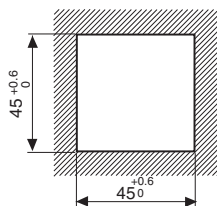

26546842 - Adaptor for 72 x 72 mm cut-out

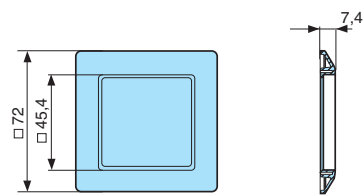

26546846 - Adaptor for 55 x 55 mm cut-out

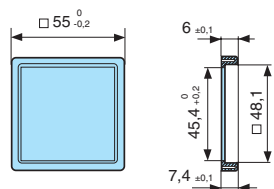

Electromechanical impulse counters

→ Impulse counters 24 x 48 - CIM24

- 5 or 6 digits, height of digits 4 mm
- With or without manual reset
- White digits on a black background



Part numbers

Type	Number of digits	Operating frequency (Hz)	Voltages	Code
Without manual reset	6	50 / 60	230 V \sim	99777714
	6	50 / 60	24 V \sim	99777710
	6	V ---	24 V ---	99777810
	6	V ---	12 V ---	99777815
With manual reset	5	50 / 60	230 V \sim	99777724
	5	50 / 60	24 V \sim	99777720
	5	V ---	24 V ---	99777820
	5	V ---	12 V ---	99777825

Accessories

Description	Code
Adaptor for 50 x 25 mm cut-out - Fixed with screws	26546843
Adaptor for 50 x 25 mm cut-out - Fixed with clips (supplied with the product)	26546844
Adaptor for 48 x 48 mm cut-out	26546849

General characteristics

General characteristics	
Counting capacity	999.999 impulses without manual reset 99.999 impulses with manual reset
Height digits (mm)	4
Max. count rate	V \sim → 10 impulses/s V --- → 10 impulses/s
Min. count rate	V \sim → 50 ms V --- → 50 ms
Min pause time between 2 pulses	V \sim → 50 ms V --- → 50 ms
Max. pulse length (count coil)	Unlimited
Voltage variation	12/24 V --- : \pm 10% V \sim : \pm 10%
Consumption	24 V \sim : 0.75 VA 230 V \sim : 1.5 VA 12/24 V --- : 0.5 W
Mechanical life count function (operations)	> 50 x 10 ⁶
Test voltage according to standard IEC 255-5	U < 60 V: 500 V U > 60 V: 2 000 V
Protection Housing	IP40
Degree of terminal protection	IP00
Environmental protection	Plated or stainless steel components
Maintenance	None
Operating position	Any
Temperature limits use (°C)	- 10 → +50
Temperature limits stored (°C)	- 40 → +80
Certifications	CE
Connection	6.35 Faston connectors or screw terminals
Mounting	With clip
Weight (g)	65

Dimensions (mm)

Panel cut-out

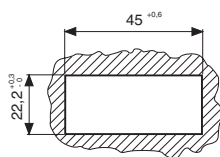

26546844 - Adaptor for 50 x 25 mm cut-out

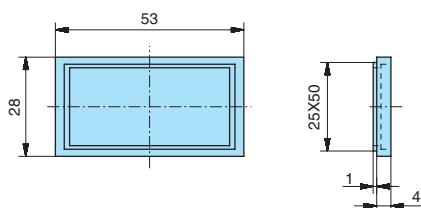

26546843 - Adaptor for 50 x 25 mm cut-out

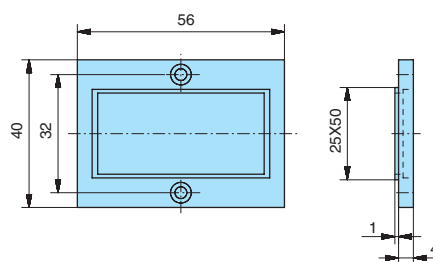

26546849 - Adaptor for 50 x 25 mm cut-out

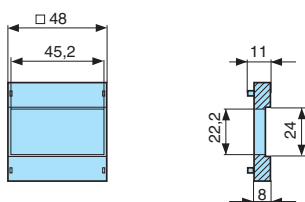

9977771/81 - 6 digits

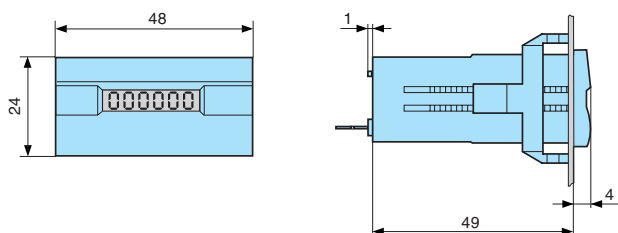

9977772/82 - 5 digits

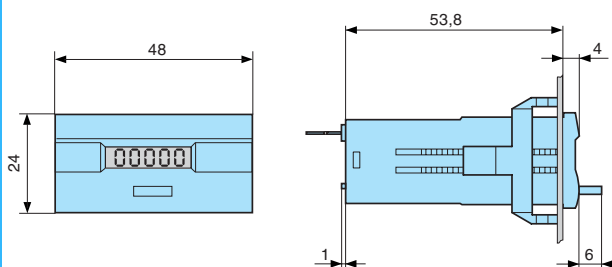

Electromechanical impulse counters

→ Impulse counters - CIM 36 x 37

- 5 or 6 digits, height of digits 4 mm
- With or without manual reset
- White digits on a black background



Part numbers

Type	Number of digits	Operating frequency (Hz)	Voltages	Code
Without manual reset	6	50 / 60	230 V~	99776601
	6	50 / 60	115 V~	99776602
	6	50 / 60	24 V~	99776604
	6	V---	110 V---	99776605
	6	V---	24 V---	99776607
With manual reset	5	50 / 60	230 V~	99776610
	5	50 / 60	115 V~	99776611
	5	50 / 60	24 V~	99776613
	5	V---	24 V---	99776616

General characteristics

General characteristics	
Counting capacity	999.999 impulses without manual reset 99.999 impulses with manual reset
Height digits (mm)	4
Max. count rate	V~ → 18 impulses/s V--- → 25 impulses/s
Min. count rate	V~ → 28 ms V--- → 20 ms
Min pause time between 2 pulses	V~ → 28 ms V--- → 20 ms
Max. pulse length (count coil)	Unlimited
Voltage variation	+ 10% / -15% Un
Consumption	24 V~ / 115 V~ : 1.1 VA 230 V~ : 2.1 VA 110 V--- : 1 W 24 V--- : 0.8 W
Mechanical life count function (operations)	> 50 x 10 ⁶
Test voltage according to standard IEC 255-5	U < 60 V: 500 V U > 60 V: 2 000 V
Protection Housing	IP40
Degree of terminal protection	IP00
Environmental protection	Plated or stainless steel components
Maintenance	None
Operating position	Any
Temperature limits use (°C)	- 10 → +60
Temperature limits stored (°C)	- 40 → +80
Certifications	CE
Connection	6.35 Faston connectors or screw terminals
Mounting	2 x 2.5 Ø screws - F90° on front face
Weight (g)	50

Dimensions (mm)

9977660 - Rear faces

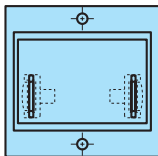

Panel cut-out

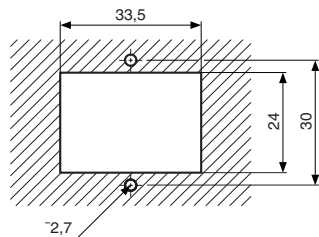

9977660 - Rear faces

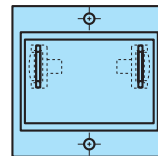

9977660 - 6 digits

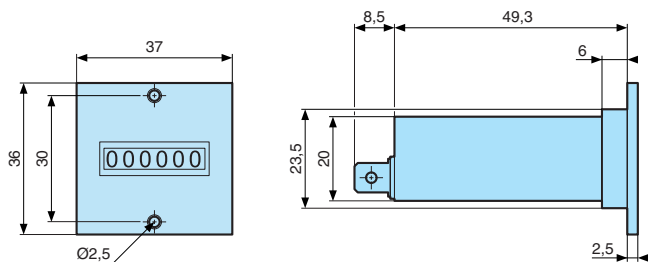

9977661 - 5 digits

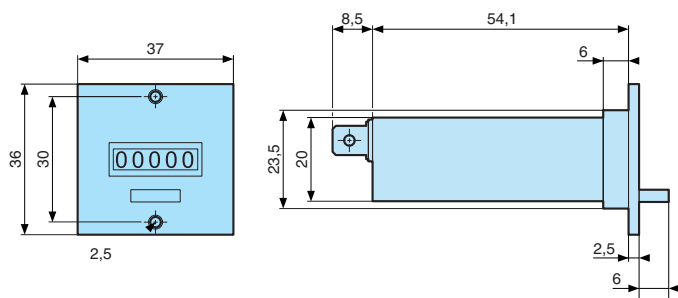

Electromechanical impulse counters

→ Impulse counters - CIM 36 x 48

- 5 or 6 digits, height of digits 4 mm
- With or without manual reset
- White digits on a black background

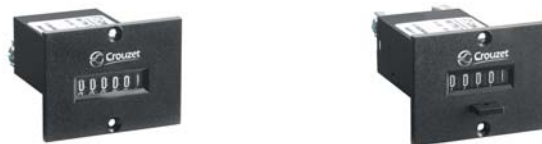

Part numbers

Type	Number of digits	Operating frequency (Hz)	Voltages	Code
Without manual reset	6	50 / 60	230 V \sim	99776701
	6	50 / 60	115 V \sim	99776702
	6	50 / 60	24 V \sim	99776704
	6	V ---	110 V ---	99776705
	6	V ---	24 V ---	99776707
	6	V ---	48 V ---	99776736
With manual reset	5	50 / 60	230 V \sim	99776710
	5	50 / 60	115 V \sim	99776711
	5	50 / 60	24 V \sim	99776713
	5	V ---	24 V ---	99776716

General characteristics

General characteristics	
Counting capacity	999.999 impulses without manual reset 99.999 impulses with manual reset
Height digits (mm)	4
Max. count rate	V \sim → 18 impulses/s V --- → 25 impulses/s
Min. count rate	V \sim → 28 ms V --- → 20 ms
Min pause time between 2 pulses	V \sim → 28 ms V --- → 20 ms
Max. pulse length (count coil)	Unlimited
Voltage variation	+ 10% / -15% Un
Consumption	24 V \sim / 115 V \sim : 1.1 VA 230 V \sim : 2.1 VA 110 V --- : 1 W 48 V --- : 0.8 W 24 V --- : 0.8 W
Mechanical life count function (operations)	> 50 x 10 ⁶
Test voltage according to standard IEC 255-5	U < 60 V: 500 V U > 60 V: 2 000 V
Protection Housing	IP40
Degree of terminal protection	IP00
Environmental protection	Plated or stainless steel components
Maintenance	None
Operating position	Any
Temperature limits use (°C)	-10 → +60
Temperature limits stored (°C)	-40 → +80
Certifications	CE
Connection	6.35 Faston connectors or screw terminals
Mounting	2 x 2.5 Ø screws - F90° on front face
Weight (g)	50

Dimensions (mm)

9977670/3 - Rear faces

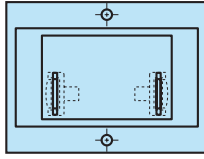

Panel cut-out

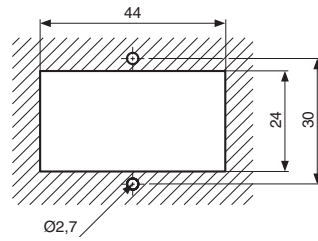

9977671 - Rear faces

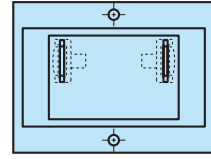

9977670/3 - 6 digits

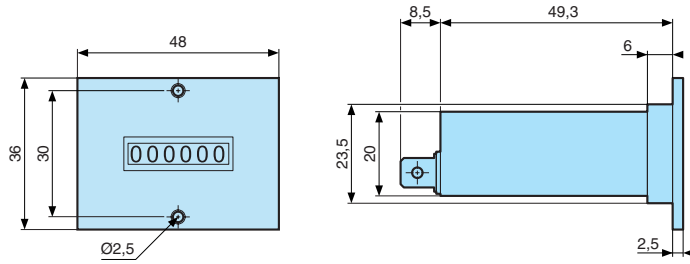

9977671 - 5 digits

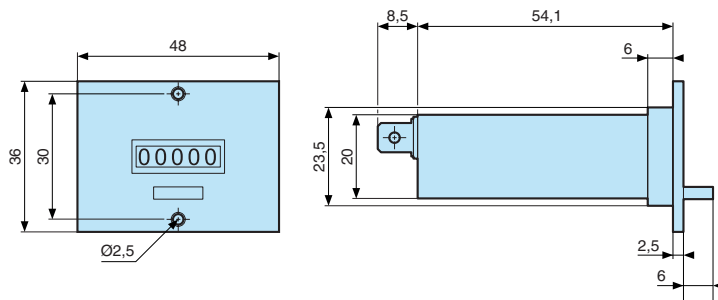

Electromechanical impulse counters

→ Impulse counters with built-in fixing clip - 15 x 32 - CIM15

- 7 digits, height of digits 4 mm
- Without manual reset
- White digits on a black background
- Compact size
- Built-in fixing clip
- IP65 (panel only)



Part numbers

Type	Operating frequency (Hz)	Voltages	Code
Without manual reset	50 / 60	24 V \sim	99778710
	50 / 60	115 V \sim	99778712
	50 / 60	230 V \sim	99778714
	V ---	5 V ---	99778805
	V ---	12 V ---	99778806
	V ---	24 V ---	99778810

General characteristics

*9.999.999	
Counting capacity	9.999.999
Height digits (mm)	4
Max. count rate	V \sim → 10 impulses/s V --- → 10 impulses/s (except for 99778810: up to 25 impulses/s)
Min. count rate	V \sim → 50 ms V --- → 50 ms
Min pause time between 2 pulses	V \sim → 50 ms V --- → 50 ms
Max. pulse length (count coil)	Unlimited
Voltage variation	V --- : \pm -10% V \sim : \pm -10%
Consumption	V \sim : 800 mVA V --- : 50 mW
Mechanical life count function (operations)	> 50 x 10 ⁶
Test voltage according to standard IEC 255-5	U < 60 V: 500 V U > 60 V: 2 000 V
Protection Housing	IP65 panel only
Degree of terminal protection	IP00
Environmental protection	Plated or stainless steel components
Maintenance	None
Operating position	Any
Temperature limits use (°C)	-10 → +60
Temperature limits stored (°C)	-40 → +80
Certifications	UL (pending) - CE
Connection	Flying leads
Mounting	Built-in fixing clip
Weight (g)	20

Dimensions (mm)

Panel cut-out

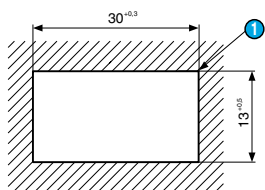

1 R max: 0.5 mm

997787/8 - 7 digits

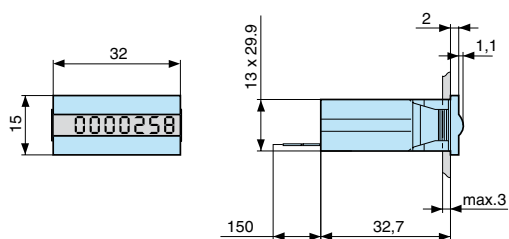

Electromechanical impulse counters

→ Screw-fixing impulse counters - CIM 24 x 48

- 5 or 6 digits, height of digits 4 mm
- With or without manual reset
- White digits on a black background



Part numbers

Type	Number of digits	Operating frequency (Hz)	Voltages	Code
Without manual reset	6	50 / 60	230 V~	99776901
	6	50 / 60	115 V~	99776902
	6	50 / 60	24 V~	99776904
	6	V---	110 V---	99776905
	6	V---	24 V---	99776907
With manual reset	5	50 / 60	230 V~	99776921
	5	50 / 60	115 V~	99776922
	5	50 / 60	24 V~	99776924
	5	V---	24 V---	99776927

General characteristics

General characteristics	
Counting capacity	999.999 impulses without manual reset 99.999 impulses with manual reset
Height digits (mm)	4
Max. count rate	V~ → 18 impulses/s V--- → 25 impulses/s
Min. count rate	V~ → 28 ms V--- → 20 ms
Min pause time between 2 pulses	V~ → 28 ms V--- → 20 ms
Max. pulse length (count coil)	Unlimited
Voltage variation	+ 10% / -15% Un
Consumption	24 V~ / 115 V~ : 1.1 VA 230 V~ : 2.1 VA 110 V--- : 1 W 24 V--- : 0.8 W
Mechanical life count function (operations)	50 x 10 ⁶
Test voltage according to standard IEC 255-5	U < 60 V: 500 V U > 60 V: 2 000 V
Protection Housing	IP40
Degree of terminal protection	IP00
Environmental protection	Plated or stainless steel components
Maintenance	None
Operating position	Any
Temperature limits use (°C)	-10 → +60
Temperature limits stored (°C)	-40 → +80
Certifications	CE
Connection	6.35 Faston connectors or screw terminals
Mounting	2 M3 screws - F90° on front face
Weight (g)	50

Dimensions (mm)

9977690 - Rear faces

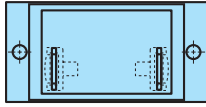

Panel cut-out

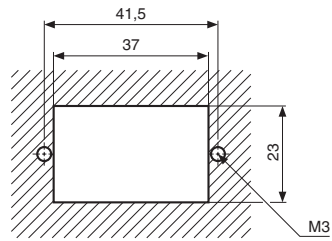

9977692 - Rear faces

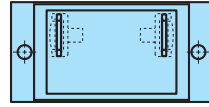

9977690 - 6 digits

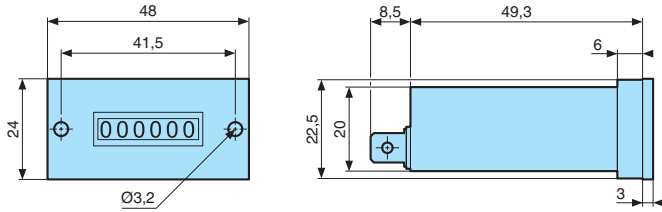

AMERICAS

CANADA

InnoVista Sensors™
1461 Lawrence Drive
Thousand Oaks, CA 91320
USA
Tel.: +1 (800) 677 5311
Fax: +1 (800) 677 3865
customer.service@us.crouzet.com

MEXICO

InnoVista Sensors™
Calzada Zavaleta 2505-C
Santa Cruz Buenavista
Puebla, 72150 - MEXICO
Tel.: +52 (222) 409 7000
mexico@crouzet.com

USA

InnoVista Sensors™
1461 Lawrence Drive
Thousand Oaks, CA 91320
USA
Tel.: +1 (800) 677 5311
Fax: +1 (800) 677 3865
customer.service@us.crouzet.com

COUNTRIES NOT LISTED

InnoVista Sensors™
1461 Lawrence Drive
Thousand Oaks, CA 91320
USA
Tel.: +1 (800) 677 5311
Fax: +1 (800) 677 3865
customer.service@us.crouzet.com

EUROPE / MIDDLE EAST / AFRICA

BELGIUM

InnoVista Sensors™
Dieweg 3 B
1180 Uccle - BELGIQUE
Tel.: +32 (0) 2 462 07 30
Fax: +32 (0) 2 461 00 23
klantenservice@crouzet.com

FRANCE

InnoVista Sensors™
2 rue du Docteur Henri Abel,
CS 60059
26902 Valence Cedex 9
FRANCE
Tel.: +33 (0) 475 802 101
Fax: +33 (0) 475 828 900
relationclient@crouzet.com

GERMANY / AUSTRIA

InnoVista Sensors™
Otto-Hahn-Str. 3
40721 Hilden
DEUTSCHLAND
Tel.: +49 (0) 2103/980-0
Fax: +49 (0) 2103/980-222
kundenservice@crouzet.com

ITALY

InnoVista Sensors™
Via Viganò De Vizzi, 93/95
20092 Cinisello Balsamo (Mi)
ITALIA
Tel.: +39 (02) 66 599 211
Fax: +39 (02) 66 599 218
assistenzaclienti@crouzet.com
www.crouzet.it

SPAIN / PORTUGAL

InnoVista Sensors™
C/Leó, 11-13 2ªª
08911 Badalona - Barcelona
ESPAÑA
Tel.: +34 (93) 484 39 70
Fax: +34 (93) 484 39 73
atencionalcliente@crouzet.com

SWITZERLAND

InnoVista Sensors™
Gewerbepark - Postfach 56
5506 Mägenwil - SCHWEIZ
Tel.: +49 (0) 2103/980-0
Fax: +49 (0) 2103/980-222
kundenservice@crouzet.com

THE NETHERLANDS

InnoVista Sensors™
Industrieweg 17
2382 NR Zoeterwoude
NEDERLAND
Tel.: +31 (0) 71-581 20 30
Fax: +31 (0) 71-541 35 74
klantenservice@crouzet.com

COUNTRIES NOT LISTED

InnoVista Sensors™
2 rue du Docteur Henri Abel,
CS 60059
26902 Valence Cedex 9
FRANCE
Tel.: +33 (0) 475 802 102
Fax: +33 (0) 475 828 900
customer.relation@crouzet.com

ASIA / PACIFIC

CHINA

InnoVista Sensors™
11th floor, Chang Feng
International Tower,
89 Yunling Road (East),
Putuo District,
Shanghai 200 062 - CHINA
Tel.: +86 (21) 8025 7166
Fax: +86 (21) 6107 1771
china@crouzet.com

INDIA

InnoVista Sensors™
4th floor, Trident Towers, #23 100
Feet Ashoka Pillar Road,
2nd Block, Jaynagar
Bangalore 560 011 - INDIA
Tel.: +91 (80) 4113 2204/05
Fax: +91 (80) 4113 2206
india@crouzet.com

SOUTH KOREA

InnoVista Sensors™
14F, Kbiz DMC Tower,
189, Seongam-Ro, Mapo-Gu,
Seoul 121-904
SOUTH KOREA
Tel.: +82 (2) 2629 8312
Fax: +82 (2) 2630 9800
korea@crouzet.com

EAST ASIA PACIFIC

InnoVista Sensors™
10/F, Wharf T&T Centre, Harbour
City, 7 Canton Road, Tsim Sha Tsui,
Kowloon, HONG KONG
Tel.: +86 (21) 8025 7177
Fax: +86 (21) 6107 1771
eap@crouzet.com

WWW.CROUZET-CONTROL.COM



WWW.INNOVISTASENSORS.COM



Warning:

The product information contained in this catalogue is given purely as information and does not constitute a representation, warranty or any form of contractual commitment. Crouzet Automatismes SAS and its subsidiaries reserve the right to modify their products without notice. It is imperative that we should be consulted over any particular use or application of our products and it is the responsibility of the buyer to establish, particularly through all the appropriate tests, that the product is suitable for the use or application. Under no circumstances will our warranty apply, nor shall we be held responsible for any application (such as any modification, addition, deletion, use in conjunction with other electrical or electronic components, circuits or assemblies, or any other unsuitable material or substance) which has not been expressly agreed by us prior to the sale of our products.

X-ON Electronics

Largest Supplier of Electrical and Electronic Components

Click to view similar products for [Counters & Tachometers](#) category:

Click to view products by [Crouzet](#) manufacturer:

Other Similar products are found below :

[LC2H-FE-2K-N](#) [LC24-F-N](#) [LC4H-R6-AC24VS](#) [GPMZC-SET](#) [26546848](#) [P2-4904](#) [2-1006](#) [H127.010A01H](#) [H5KLR-11](#) [100-240V AC/DC](#)
[H7CX-AW-N](#) [HED251-T](#) [1.230.301.038](#) [3.550.401.075](#) [3.550.401.351](#) [LC2H-C-2K-N](#) [LC2H-C-30-N](#) [LC4H-R4-AC240VS](#) [LC4H-R6-](#)
[AC240V](#) [1-4625](#) [1-4635](#) [1.150.510.013.550](#) [1.150.510.054.550](#) [1.150.510.056.550](#) [6.560.010.300](#) [SLE-73-1400-1-4-01](#) [SLIK-94-1521-1-3-](#)
[001](#) [SLN-94-1421-1-3](#) [6.924.0103.300](#) [SPI-73-1411-1-3-011](#) [SPI-73-1411-1-4-011](#) [CT6S-1P4](#) [Y-50](#) [LC4H-R4-AC24V](#) [LC4H-R4-DC24V](#)
[LC4H-S-R6-24VS](#) [CT6S-2P4](#) [H127.010A01G](#) [H5KLR-11](#) [12-48V AC/DC](#) [H5KLR-8B](#) [12-48 AC/DC](#) [H7CX-A11-N](#) [H7CX-AD-N](#) [H7CX-](#)
[AU-N](#) [H7ER-NV1](#) [H8DA](#) [12-48V AC/DC](#) [87622062](#) [99778714](#) [99776924](#) [CLI-02](#) [E53-COV19](#) [FX4S-1P4](#)