

# UR SERIES VOLTAGE CONTROL RELAY

UL listed CSA recognized

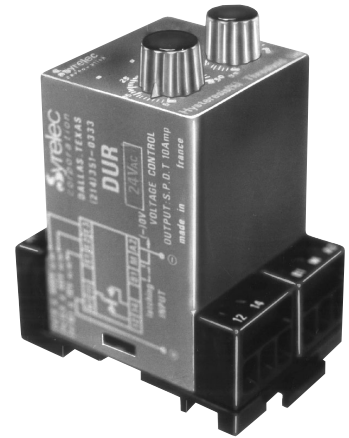

- **AC or DC Voltage Control**
- **Manual or Automatic Operation**
- **Adjustable Threshold**
- **5 to 50% Hysteresis Range**
- **LED Relay Status Indicator**

### 1. AC/DC voltage control without latching:

The output relay is energized when the voltage (AC peak voltage) exceeds the selected threshold. It de-energizes when the voltage falls below the hysteresis setting (5 to 50%) or when supply breaks. The hysteresis is controlled by a potentiometer and its selection does not change the chosen threshold.

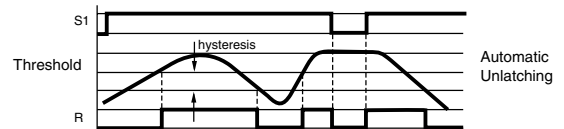

### 2. AC/DC voltage control with latching:

The output relay is energized when the voltage reaches the selected threshold and stays latched in this position. The contact between terminal B1 and M (or 8 or 9) should be opened or the input power of the device interrupted to reset.

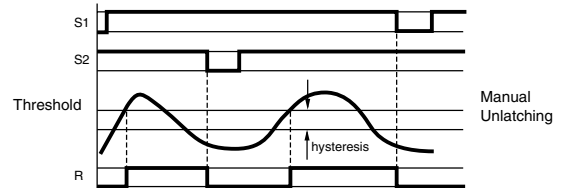

### SPECIFICATIONS:

Input	24 VDC, 24, 48, 110, 220 VAC		
	±15%, 50/60 Hz		
Power consumption	24 VAC: 1 VA		
	48 VAC: 1.2 VA		
	110 VAC: 3.5 VA		
	220 VAC: 7 VA		
<b>Control Range</b>	<b>Input Resistance</b>	<b>Acceptance load (input)</b>	
<b>AC or DC</b>		<b>Permanent (max)</b>	<b>Less than 10ms peak max.</b>
0.1 to 10 V	10 kΩ	50 V	100 V
0.4 to 40 V	40 kΩ	100 V	300 V
4 to 400 V	400 kΩ	440 V	750 V
<b>Hysteresis selection</b>	5 to 50% of set point		
<b>Repeat accuracy</b>	±2% at a constant ambient		
<b>Output Relay</b>	SPDT Relay		
<b>Contact material</b>	AgCdO		
<b>Maximum loading</b>	10 A AC resistive 8 A DC inductive		
<b>Maximum switching voltage</b>	250 VAC		250 VDC
<b>Relay maximum power rating</b>	2200 VA		
<b>Transient protection</b>	2500 volts		30 W
<b>Mechanical life of relay</b>	30 x 10 <sup>6</sup> operations		
<b>Electrical life of relay</b>	2 x 10 <sup>5</sup> at 2400 VA resistive load		
<b>Repetition accuracy</b>	±0.5% at a constant ambient		
<b>Response time</b>	100 ms on make		
	200 ms on break		
<b>Operating temperature</b>	-4°F to +140°F		-20°C to +60°C
<b>Weight</b>	7 oz. (200g)		

**Option:** 24 VDC power – the voltage and the measured current must be from separate sources.

### ORDERING INFORMATION:



Products and specifications subject to change without notice.

Order/Technical Support – Tel: (800) 677-5311 / FAX: (800) 677-3865 / www.crouzet-usa.com

# SR SERIES UNDER VOLTAGE RELAY

UL listed CSA recognized

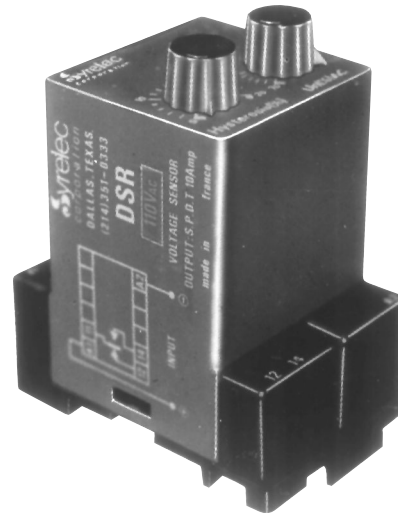

- Multiple AC/DC Voltages
- 5 to 20% Hysteresis Adjustment
- Automatic Operation
- Adjustable Threshold

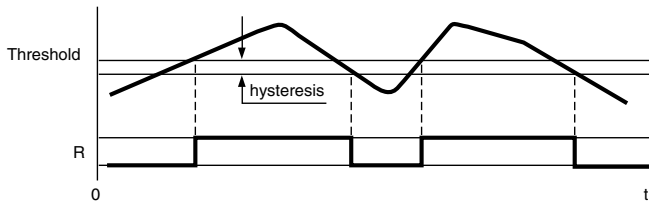

The voltage threshold SR Relay controls a voltage supply which is its own supply. The output relay is energized when the supply (effective for AC) exceeds the selected threshold. It de-energizes when the controlled supply falls below (5 to 20% Hysteresis) of the supply voltage or when the input power breaks. Hysteresis is controlled by a potentiometer and its selection does not change the chosen threshold. Pulses or drops of 100ms or less are ignored.

**SPECIFICATIONS:**

<b>Input</b> .....	.12 VDC, 24 VAC, 24 VDC, 48 VAC
	48 VDC, 110 VAC, 220 VAC, 50/60 Hz
	-20% to +30% DC,
	-30% to +15% AC
<b>Maximum power consumption</b> ..	.24 VAC: 1.5 VA      24 VDC: .6 W
	48 VAC: 2 VA        24 VDC: .8 W
	110 VAC: 5 VA       48 VDC: 1.8 W
	220 VAC: 11 VA
<b>Residual ripple</b> .....	<Hysteresis value
<b>Output relay</b> .....	.SPDT Relay
<b>Contact material</b> .....	AgCdO
<b>Maximum loading</b> .....	.10 A AC resistive    8 A DC inductive
<b>Maximum switching voltage</b> .....	.250 VAC                250 VDC
<b>Maximum power rating</b> .....	.2200 VA                80 W
<b>Mechanical life of relay</b> .....	.30 x 10 <sup>6</sup> operations
<b>Electrical life of relay</b> .....	.2 x 10 <sup>6</sup> at 2200 VA resistive load
<b>Operating temperature</b> .....	+14°F to 140°F      -10°C to +60°C
<b>Weight</b> .....	.2.8 oz. (100g)

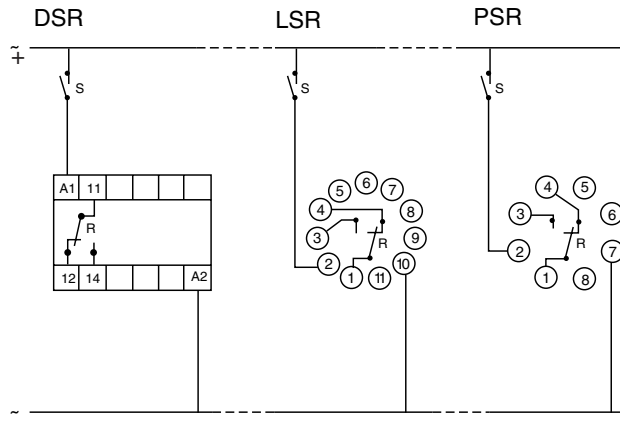

**ORDERING INFORMATION:**

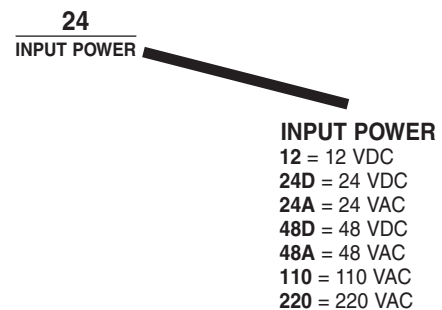

Products and specifications subject to change without notice.

Order/Technical Support – Tel: (800) 677-5311 / FAX: (800) 677-3865 / www.crouzet-usa.com

## X-ON Electronics

Largest Supplier of Electrical and Electronic Components

*Click to view similar products for [Industrial Relays](#) category:*

*Click to view products by [Crouzet](#) manufacturer:*

Other Similar products are found below :

[6-1617801-8](#) [6-1618107-9](#) [7-1618273-3](#) [EV250-4A-02](#) [EV250-6A-01](#) [FCA-125-CX8](#) [FCA-325-159](#) [FCA-410-138](#) [8000-S3121](#) [8-1618273-6](#)  
[8-1618393-1](#) [GCA63A220VAC60HZ](#) [GCA63A277VAC60HZ](#) [GCA63A600VAC60HZ](#) [1-1672275-3](#) [1-1833005-4](#) [H-16/S1](#) [A711Z](#) [H-8C](#)  
[H-8/S11](#) [H-8/S68](#) [ACC530U20](#) [ACC730U30](#) [RF303ZM4-12](#) [DH18DA](#) [1423675-8](#) [AR4-15F13-C01](#) [AR7-41F11](#) [AVR907](#) [15732A200](#)  
[B07B032AC1-0329](#) [B329](#) [B490A](#) [1618279-1](#) [BHR124Y](#) [1810DDB-SX](#) [N417](#) [P30C42A12D1-120](#) [2-1617748-6](#) [2-1618375-1](#) [2-1618396-6](#)  
[2-1618398-1](#) [JMAPD-5XL](#) [JMGACD-5M](#) [JMGSC-5LW](#) [JMGSCD-5L](#) [PBO-18A1218](#) [PBO-40A3040](#) [K8DSPH1200480VAC](#) [KA-3C-12A](#)