

UR SERIES VOLTAGE CONTROL RELAY

UL listed CSA recognized

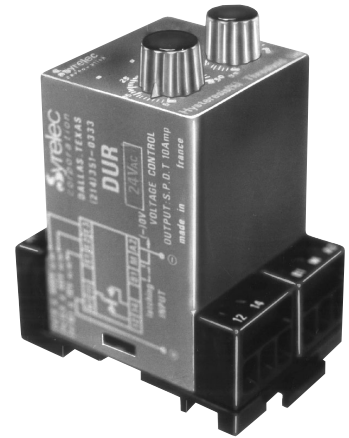

- **AC or DC Voltage Control**
- **Manual or Automatic Operation**
- **Adjustable Threshold**
- **5 to 50% Hysteresis Range**
- **LED Relay Status Indicator**

1. AC/DC voltage control without latching:

The output relay is energized when the voltage (AC peak voltage) exceeds the selected threshold. It de-energizes when the voltage falls below the hysteresis setting (5 to 50%) or when supply breaks. The hysteresis is controlled by a potentiometer and its selection does not change the chosen threshold.

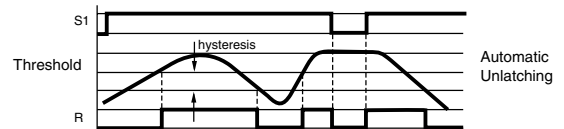

2. AC/DC voltage control with latching:

The output relay is energized when the voltage reaches the selected threshold and stays latched in this position. The contact between terminal B1 and M (or 8 or 9) should be opened or the input power of the device interrupted to reset.

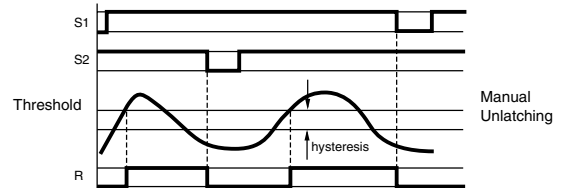

SPECIFICATIONS:

Input	24 VDC, 24, 48, 110, 220 VAC		
	±15%, 50/60 Hz		
Power consumption	24 VAC: 1 VA		
	48 VAC: 1.2 VA		
	110 VAC: 3.5 VA		
	220 VAC: 7 VA		
Control Range	Input Resistance	Acceptance load (input)	
AC or DC		Permanent (max)	Less than 10ms peak max.
0.1 to 10 V	10 kΩ	50 V	100 V
0.4 to 40 V	40 kΩ	100 V	300 V
4 to 400 V	400 kΩ	440 V	750 V
Hysteresis selection	5 to 50% of set point		
Repeat accuracy	±2% at a constant ambient		
Output Relay	SPDT Relay		
Contact material	AgCdO		
Maximum loading	10 A AC resistive 8 A DC inductive		
Maximum switching voltage	250 VAC		250 VDC
Relay maximum power rating	2200 VA		
Transient protection	2500 volts		30 W
Mechanical life of relay	30 x 10 ⁶ operations		
Electrical life of relay	2 x 10 ⁵ at 2400 VA resistive load		
Repetition accuracy	±0.5% at a constant ambient		
Response time	100 ms on make		
	200 ms on break		
Operating temperature	-4°F to +140°F		-20°C to +60°C
Weight	7 oz. (200g)		

Option: 24 VDC power – the voltage and the measured current must be from separate sources.

ORDERING INFORMATION:



SR SERIES UNDER VOLTAGE RELAY

UL listed CSA recognized

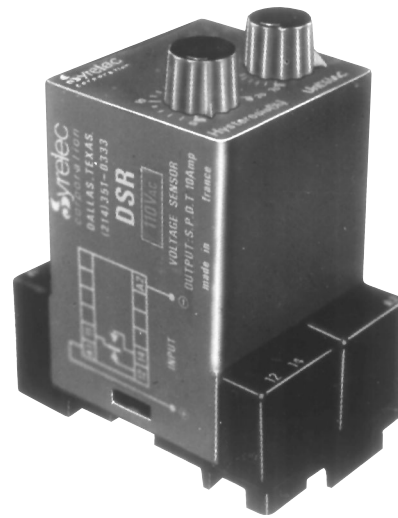

- Multiple AC/DC Voltages
- 5 to 20% Hysteresis Adjustment
- Automatic Operation
- Adjustable Threshold

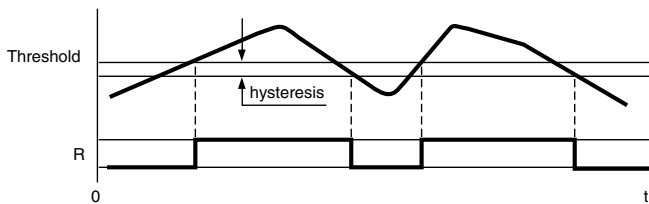

The voltage threshold SR Relay controls a voltage supply which is its own supply. The output relay is energized when the supply (effective for AC) exceeds the selected threshold. It de-energizes when the controlled supply falls below (5 to 20% Hysteresis) of the supply voltage or when the input power breaks. Hysteresis is controlled by a potentiometer and its selection does not change the chosen threshold. Pulses or drops of 100ms or less are ignored.

SPECIFICATIONS:

Input12 VDC, 24 VAC, 24 VDC, 48 VAC
	48 VDC, 110 VAC, 220 VAC, 50/60 Hz
	-20% to +30% DC,
	-30% to +15% AC
Maximum power consumption ..	.24 VAC: 1.5 VA 24 VDC: .6 W
	48 VAC: 2 VA 24 VDC: .8 W
	110 VAC: 5 VA 48 VDC: 1.8 W
	220 VAC: 11 VA
Residual ripple	<Hysteresis value
Output relaySPDT Relay
Contact material	AgCdO
Maximum loading10 A AC resistive 8 A DC inductive
Maximum switching voltage250 VAC 250 VDC
Maximum power rating2200 VA 80 W
Mechanical life of relay30 x 10 ⁶ operations
Electrical life of relay2 x 10 ⁶ at 2200 VA resistive load
Operating temperature	+14°F to 140°F -10°C to +60°C
Weight2.8 oz. (100g)

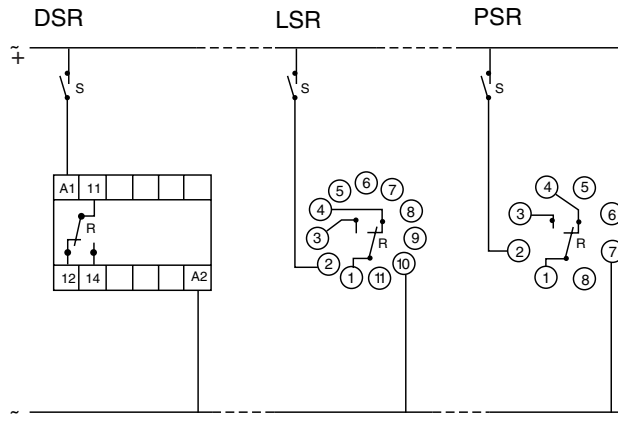

ORDERING INFORMATION:

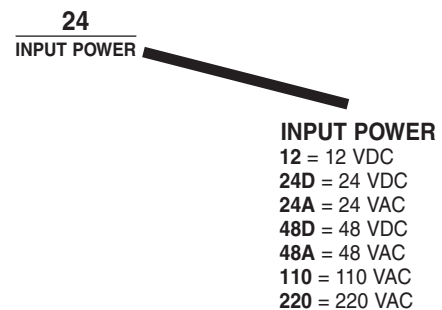
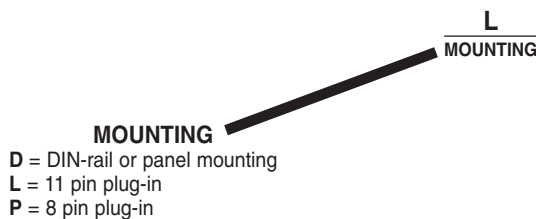

Products and specifications subject to change without notice.

Order/Technical Support – Tel: (800) 677-5311 / FAX: (800) 677-3865 / www.crouzet-usa.com

X-ON Electronics

Largest Supplier of Electrical and Electronic Components

Click to view similar products for [Industrial Relays](#) category:

Click to view products by [Crouzet](#) manufacturer:

Other Similar products are found below :

[6-1617801-8](#) [6-1618107-9](#) [7-1618273-3](#) [EV250-4A-02](#) [EV250-6A-01](#) [FCA-125-CX8](#) [FCA-325-159](#) [FCA-410-138](#) [8000-S3121](#) [8-1618273-6](#)
[8-1618393-1](#) [GCA63A220VAC60HZ](#) [GCA63A277VAC60HZ](#) [GCA63A600VAC60HZ](#) [1-1672275-3](#) [1-1833005-4](#) [H-16/S1](#) [A711Z](#) [H-8C](#)
[H-8/S11](#) [H-8/S68](#) [ACC530U20](#) [ACC730U30](#) [RF303ZM4-12](#) [DH18DA](#) [1423675-8](#) [AR4-15F13-C01](#) [AR7-41F11](#) [AVR907](#) [15732A200](#)
[B07B032AC1-0329](#) [B329](#) [B490A](#) [1618279-1](#) [BHR124Y](#) [1810DDB-SX](#) [N417](#) [P30C42A12D1-120](#) [2-1617748-6](#) [2-1618375-1](#) [2-1618396-6](#)
[2-1618398-1](#) [JMAPD-5XL](#) [JMGACD-5M](#) [JMGSC-5LW](#) [JMGSCD-5L](#) [PBO-18A1218](#) [PBO-40A3040](#) [K8DSPH1200480VAC](#) [KA-3C-12A](#)