

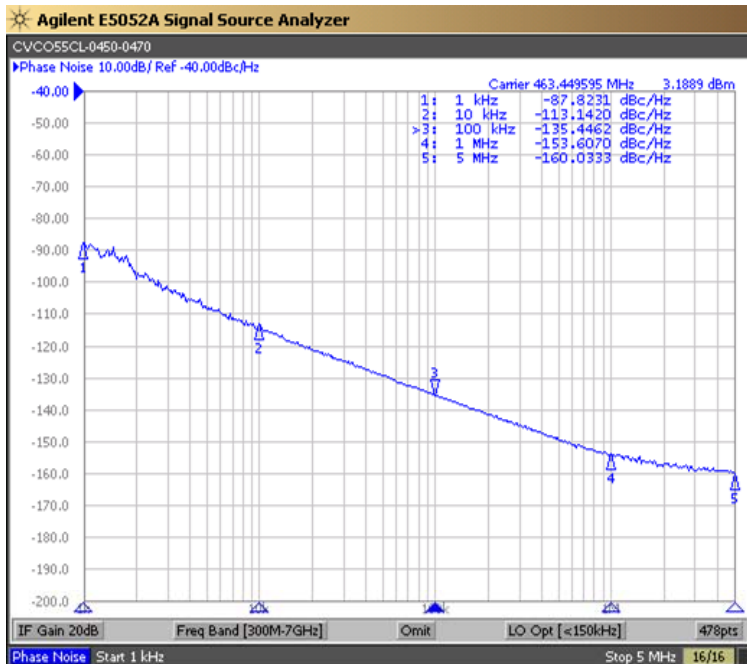

PERFORMANCE SPECIFICATION	MIN	TYP	MAX	UNITS
Lower Frequency:			450	MHz
Upper Frequency:	470			MHz
Tuning Voltage:	1.5		3.5	VDC
Supply Voltage:	4.75	5.0	5.25	VDC
Output Power:	-2.0	2.0	+6.0	dBm
Supply Current:		16	25	mA
Harmonic Suppression (2 nd Harmonic):		-15	-10	dBc
Pushing:	0.5		2.0	MHz/V
Pulling, all Phases:		0.5	2.0	MHz pk-pk
Tuning Sensitivity:		20		MHz/V
Phase Noise @ 10kHz offset:		-110		dBc/Hz
Phase Noise @ 100kHz offset:		-133		dBc/Hz
Load Impedance:		50		Ω
Input Capacitance:			100	pF
Operating Temperature Range:	-40		+85	$^{\circ}$ C
Storage Temperature Range:	-45		+90	$^{\circ}$ C

Phase Noise (1 Hz BW, Typical)



Tuning Curve (Typical)

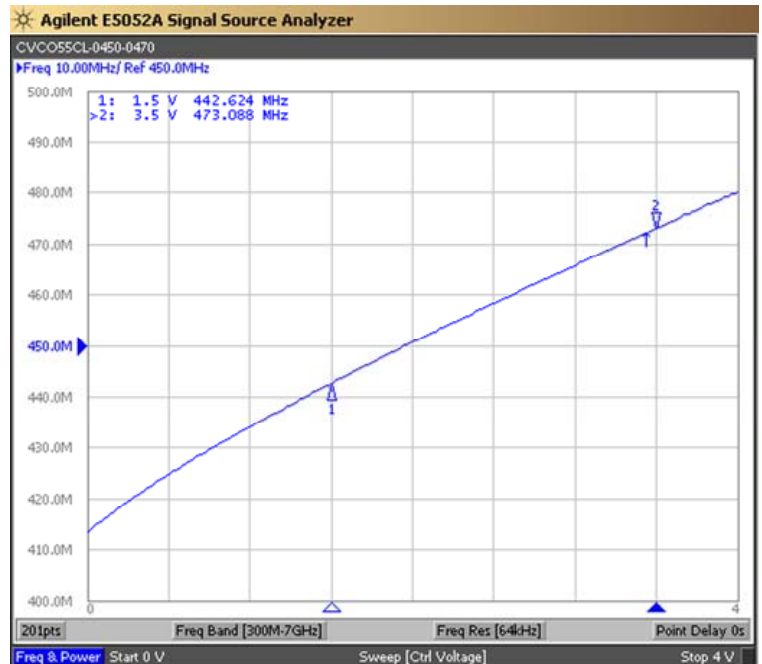

Product Control:

Crystek Part Number:	CVCO55CL-0450-0470	Release Date:	31-Jan-2018
Revision Level:	E	Responsible:	C. Vales



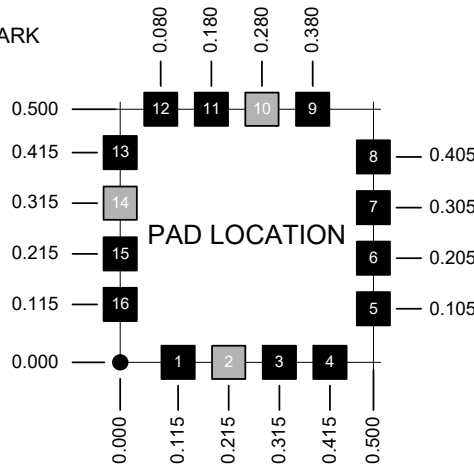
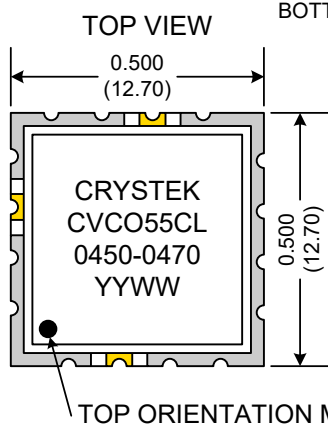
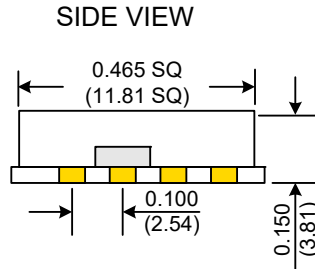
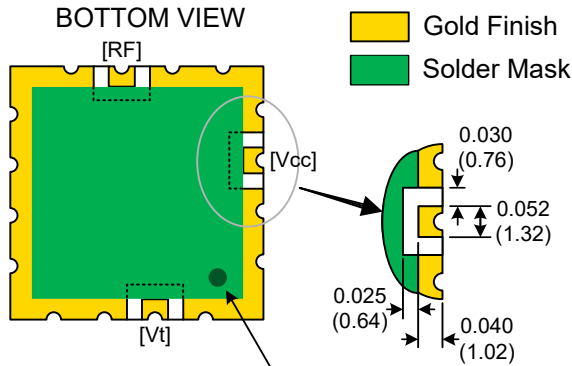

Pad	Connection
2	Vt
10	RF-OUTPUT
14	Vcc
Others	GROUND

- Unless otherwise specified, Dimensions are in: $\frac{IN}{(mm)}$
- Pad Location Dimensions are in: Inches

TAPE AND REEL

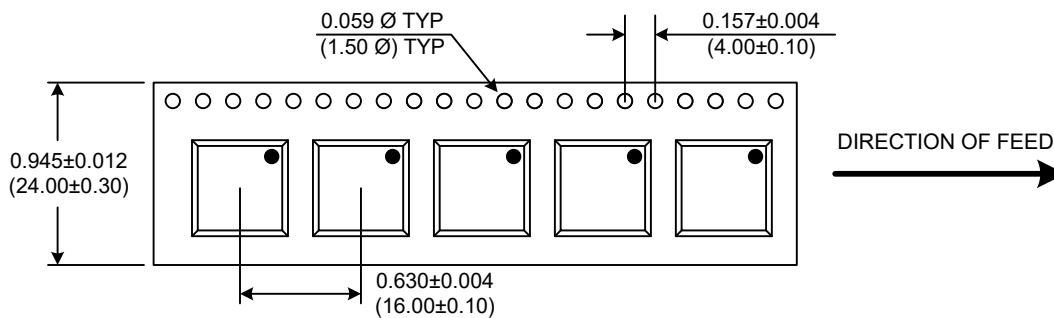

Drawing not to scale

Product Control:

Crystek Part Number:	CVCO55CL-0450-0470	Release Date:	31-Jan-2018
Revision Level:	E	Responsible:	C. Vales

Specification is subject to change without notice

X-ON Electronics

Largest Supplier of Electrical and Electronic Components

Click to view similar products for [VCO Oscillators](#) category:

Click to view products by [Crystek](#) manufacturer:

Other Similar products are found below :

[MAOC-009260-SMB003](#) [MAOC-009261-PKG003](#) [MAOC-009872-000000](#) [MAOC-009264-PKG003](#) [HMC384LP4ETR](#) [CVCO33CL-0110-0150](#) [CVCO33CL-0415-0435](#) [CVCO33CL-0750-0770](#) [HMC1166LP5ETR](#) [HMC391LP4TR](#) [HMC1168LP5ETR](#) [MAOC-009260-PKG003](#) [MAOC-009266-PKG003](#) [HMC511LP5ETR](#) [HMC534LP5ETR](#) [HMC431LP4ETR](#) [HMC3587LP3BETR](#) [CVC055CC-1680-1680](#) [CVCO33CL-0125-0200](#) [CVCO45CL-0100-0140](#) [CVCO45CL-0421-0441](#) [CRBV55BE-1930-1990](#) [MAX2609EUT+T](#) [HMC1160LP5E](#) [HMC1164LP5E](#) [HMC1166LP5E](#) [HMC1167LP5E](#) [HMC1168LP5E](#) [HMC587LC4BTR](#) [HMC732LC4B](#) [HMC358MS8GE](#) [HMC384LP4E](#) [HMC385LP4E](#) [HMC388LP4E](#) [HMC390LP4E](#) [HMC391LP4](#) [HMC391LP4E](#) [HMC398QS16GE](#) [HMC401QS16GE](#) [HMC416LP4E](#) [HMC429LP4E](#) [HMC430LP4E](#) [HMC466LP4E](#) [HMC506LP4](#) [HMC507LP5E](#) [HMC508LP5E](#) [HMC509LP5](#) [HMC510LP5E](#) [HMC511LP5E](#) [HMC512LP5E](#)