



# CT354 Series AC Input 4-Pin Mini-Flat DMC-Isolator® Phototransistor Optocoupler

## Features

- High isolation 3750 VRMS
- Patented coplanar structure DMC-Isolator®
- Various CTR selection available
- AC input with transistor output
- Operating temperature range - 55 °C to 110 °C
- RoHS and REACH Compliance
- Halogen Free Compliance
- Regulatory Approvals
  - ✓ UL - UL1577 (E364000)
  - ✓ VDE - EN60747-5-5 (40039590)
  - ✓ CQC – GB4943.1, GB8898 (14001105803)
  - ✓ IEC62368 (FI/41119)

## Description

The CT354 series of AC input optocoupler consists of a photo transistor optically coupled to two Infrared-emitting diodes in a 4-lead Mini-Flat DMC-Isolator® package with bending option.

## Applications

- Switch mode power supplies
- Computer peripheral interface
- Microprocessor system interface

## Package Outline

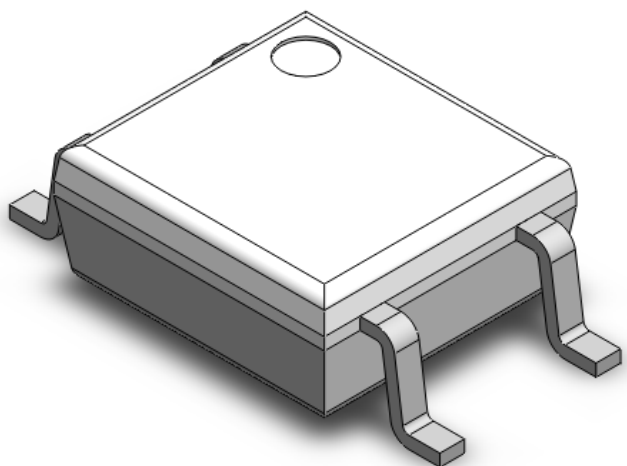

## Schematic

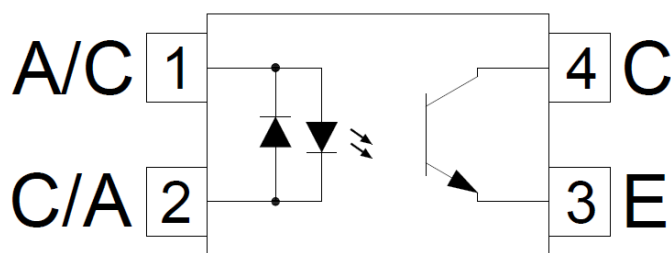



# CT354 Series

## AC Input 4-Pin Mini-Flat DMC-Isolator<sup>®</sup>

### Phototransistor Optocoupler

#### Absolute Maximum Ratings $T_A = 25^{\circ}\text{C}$ , unless otherwise specified

Stresses in excess of the absolute maximum ratings can cause permanent damage to the device. Functional operation of the device is not implied at these or any other conditions in excess of those given in the operational sections of this document. In addition, extended exposure to stresses above the recommended operating conditions may affect device reliability. The absolute maximum ratings are stress ratings only.

Symbol	Parameters	Ratings	Units	Notes
V <sub>ISO</sub>	Isolation voltage	3750	V <sub>RMS</sub>	
T <sub>OPR</sub>	Operating temperature	-55 ~ +110	°C	
T <sub>STG</sub>	Storage temperature	-55 ~ +150	°C	
T <sub>SOL</sub>	Soldering temperature	260	°C	
P <sub>TOT</sub>	Total power dissipation	200	mW	
<b>Emitter</b>				
I <sub>F</sub>	Forward current	±50	mA	
I <sub>F(TRANS)</sub>	Peak transient current (≤1μs P.W,300pps)	1	A	
P <sub>D</sub>	Power dissipation	70	mW	
<b>Detector</b>				
P <sub>C</sub>	Power dissipation	150	mW	
B <sub>VCEO</sub>	Collector-Emitter Breakdown Voltage	80	V	
B <sub>VECO</sub>	Emitter-Collector Breakdown Voltage	7	V	
I <sub>C</sub>	Collector Current	50	mA	



# CT354 Series AC Input 4-Pin Mini-Flat DMC-Isolator<sup>®</sup> Phototransistor Optocoupler

## Electrical Characteristics $T_A = 25^\circ\text{C}$ , unless otherwise specified

### Emitter Characteristics

Symbol	Parameters	Test Conditions	Min	Typ	Max	Units	Notes
$V_F$	Forward voltage	$I_F = \pm 10\text{mA}$		1.24	1.4	V	
$C_{IN}$	Input Capacitance	$f = 1\text{kHz}$	-	45	-	pF	

### Detector Characteristics

Symbol	Parameters	Test Conditions	Min	Typ	Max	Units	Notes
$B_{V_{CEO}}$	Collector-Emitter Breakdown	$I_C = 100\mu\text{A}$	80	-	-	V	
$B_{V_{ECO}}$	Emitter-Collector Breakdown	$I_E = 100\mu\text{A}$	7	-	-	V	
$I_{CEO}$	Collector-Emitter Dark Current	$V_{CE} = 20\text{V}$ , $I_F = 0\text{mA}$	-	-	100	nA	

### Transfer Characteristics

Symbol	Parameters	Test Conditions	Min	Typ	Max	Units	Notes
CTR	Current Transfer Ratio	CT354	$I_F = \pm 1\text{mA}$ , $V_{CE} = 5\text{V}$	20	-	300	%
		CT354A		50	-	150	
		CT354B		100	-	300	
	CTR Symmetry	$I_F = \pm 1\text{mA}$ , $V_{CE} = 5\text{V}$	0.7	-	1.3		
$V_{CE(SAT)}$	Collector-Emitter Saturation Voltage	$I_F = \pm 20\text{mA}$ , $I_C = 1\text{mA}$	-	0.1	0.2	V	
$R_{IO}$	Isolation Resistance	$V_{IO} = 500\text{V}_{DC}$	$5 \times 10^{10}$	-	-	$\Omega$	
$C_{IO}$	Isolation Capacitance	$f = 1\text{MHz}$	-	0.6	1.0	pF	

### Switching Characteristics

Symbol	Parameters	Test Conditions	Min	Typ	Max	Units	Notes
$t_r$	Rise Time	$I_C = 2\text{mA}$ , $V_{CE} = 2\text{V}$ , $R_L = 100\Omega$	-	6	18	$\mu\text{s}$	
$t_f$	Fall Time		-	8	18		



# CT354 Series AC Input 4-Pin Mini-Flat DMC-Isolator<sup>®</sup> Phototransistor Optocoupler

## Typical Characteristic Curves $T_A = 25^\circ\text{C}$ , unless otherwise specified

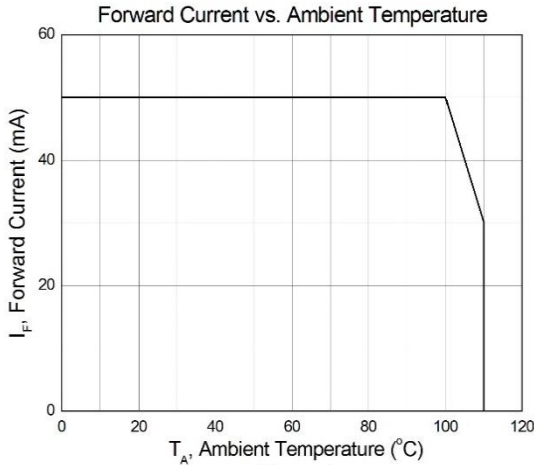

Figure 1

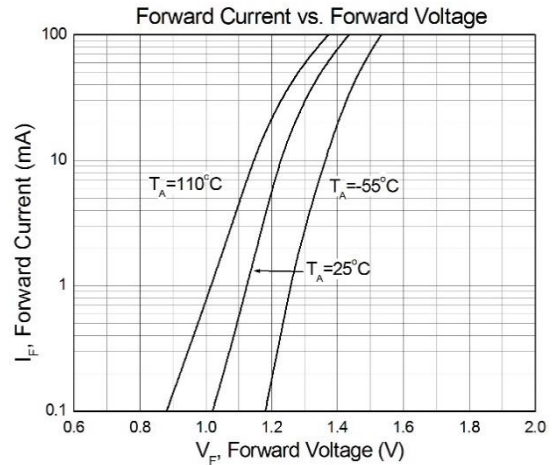

Figure 2

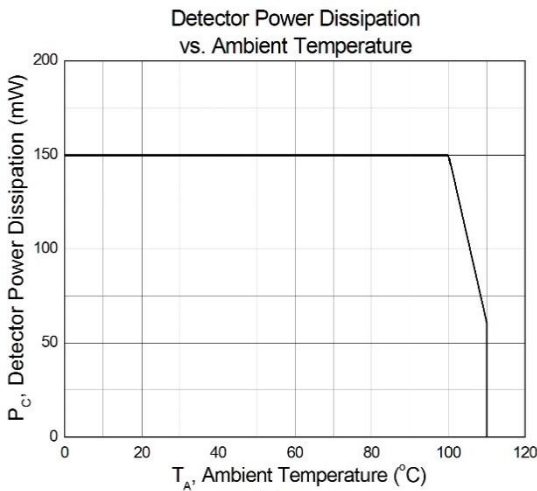

Figure 3

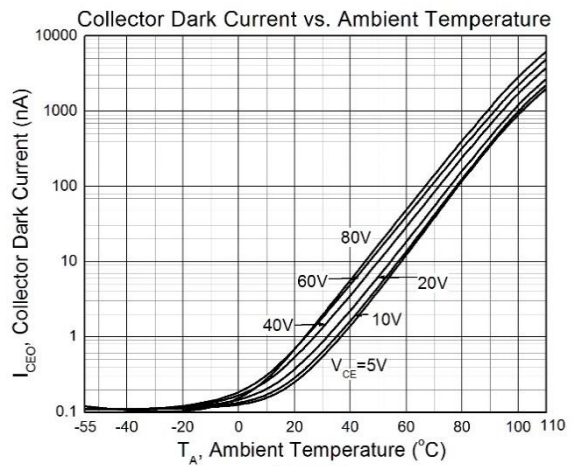

Figure 4

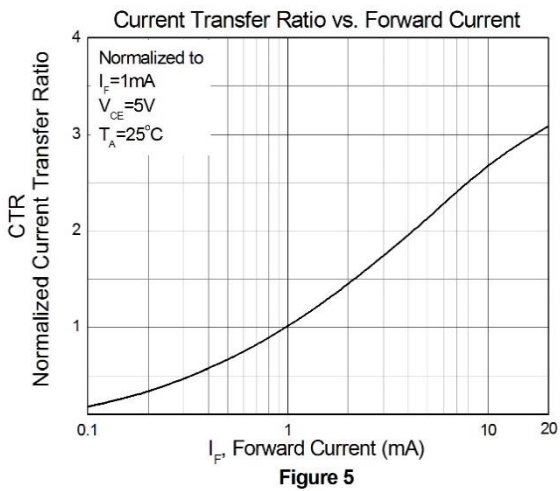

Figure 5

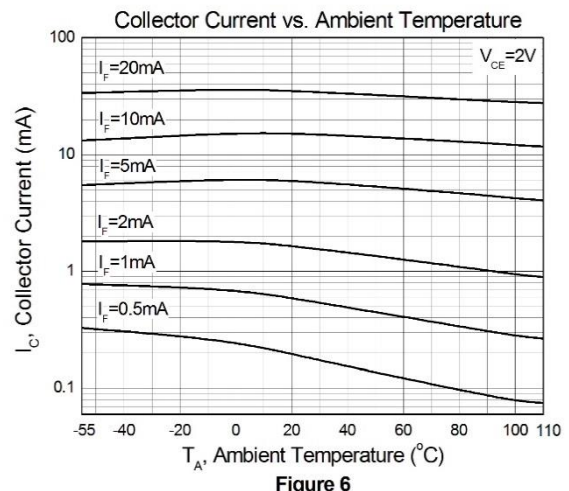

Figure 6



# CT354 Series

## AC Input 4-Pin Mini-Flat DMC-Isolator<sup>®</sup>

### Phototransistor Optocoupler

### Typical Characteristic Curves $T_A = 25^\circ\text{C}$ , unless otherwise specified (Continued)

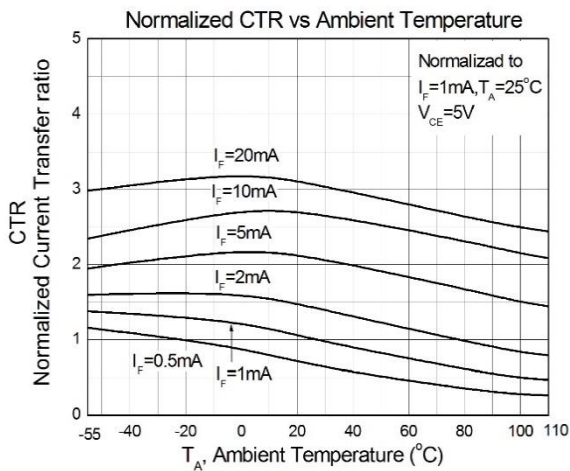

Figure 7

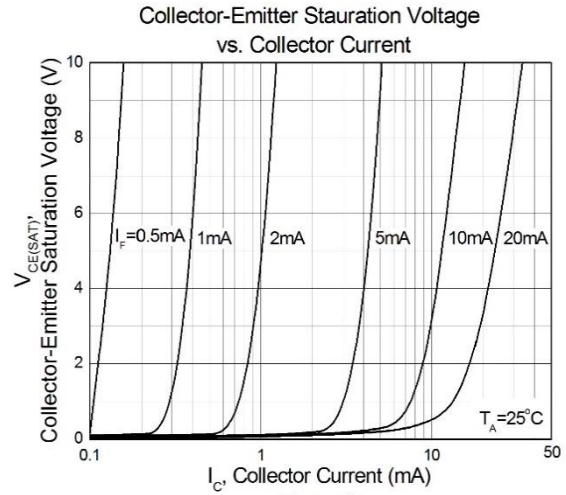

Figure 8

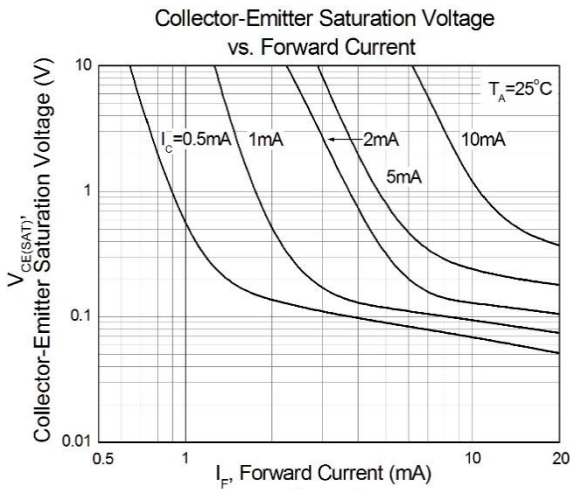

Figure 9

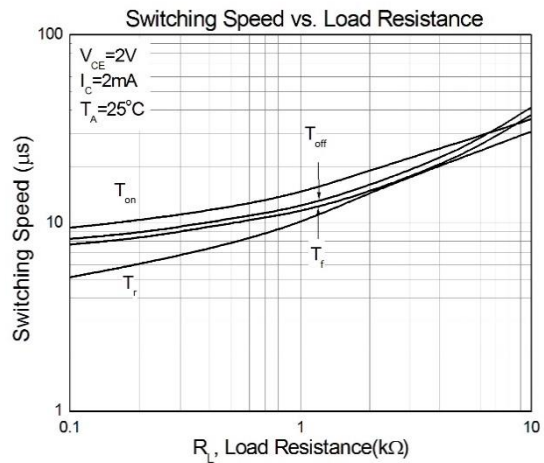

Figure 10

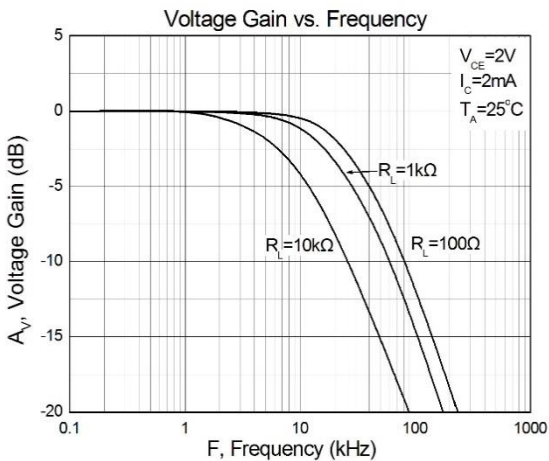

Figure 11

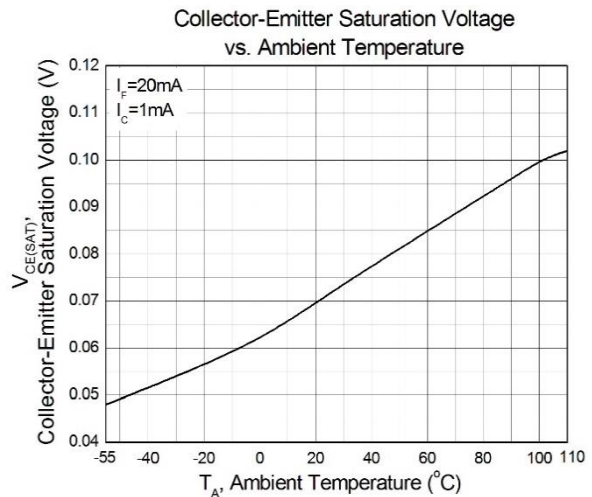

Figure 12



# CT354 Series AC Input 4-Pin Mini-Flat DMC-Isolator<sup>®</sup> Phototransistor Optocoupler

## Test Circuit

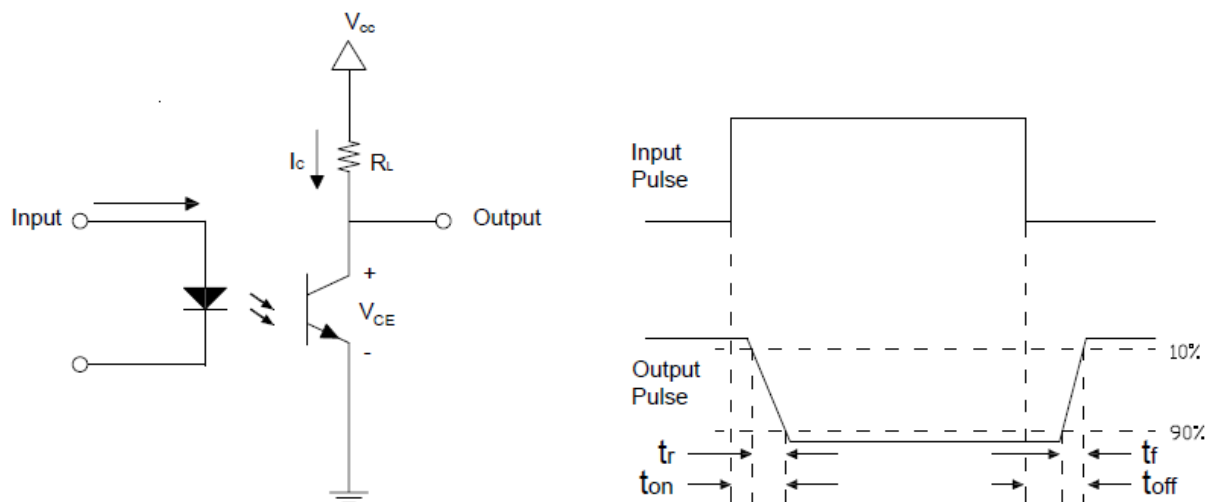
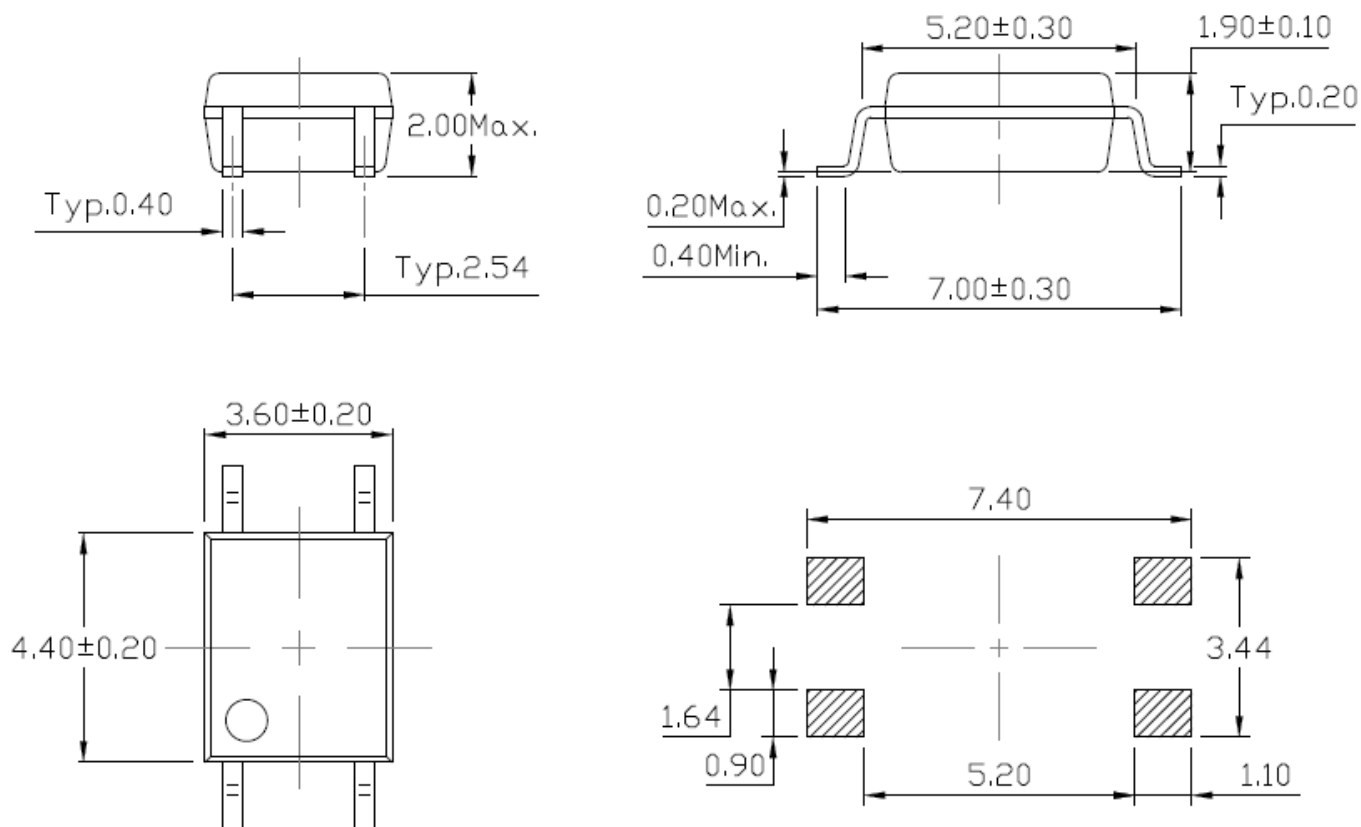

Figure 13: Switching Time Test Circuit



Package Dimension *Dimensions in mm unless otherwise stated*



Marking Information



Note:

- CT : Denotes "CT Micro"
- 354 : Part Number
- X : CTR Rank (Blank, A or B)
- V : VDE Safety Mark Option (Blank or V)
- Y : One Digit Year Code
- WW : Two Digit Work Week
- K : Manufacturing Code



# CT354 Series AC Input 4-Pin Mini-Flat DMC-Isolator<sup>®</sup> Phototransistor Optocoupler

## Ordering Information

### CT354X (V)(Z)

- CT = Denotes “CT Micro”
- 354 = Part Number
- X = CTR Rank Option (Blank, A or B)
- V = VDE Safety Mark Option (Blank or V)
- Z = Tape and Reel Option (T1 or T2)

Option	Description	Quantity
T1	Surface Mount Lead Forming – With Option 1 Taping	3000 Units/Reel
T2	Surface Mount Lead Forming – With Option 2 Taping	3000 Units/Reel

## Reel Dimension *All dimensions are in mm, unless otherwise stated*

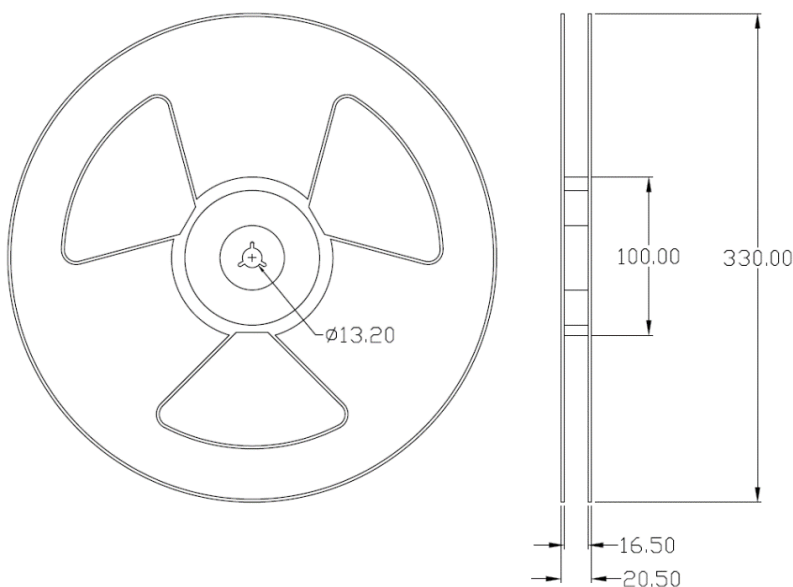





# CT354 Series AC Input 4-Pin Mini-Flat DMC-Isolator<sup>®</sup> Phototransistor Optocoupler

## Carrier Tape Specifications *Dimensions in mm unless otherwise stated*

### Option (T1)

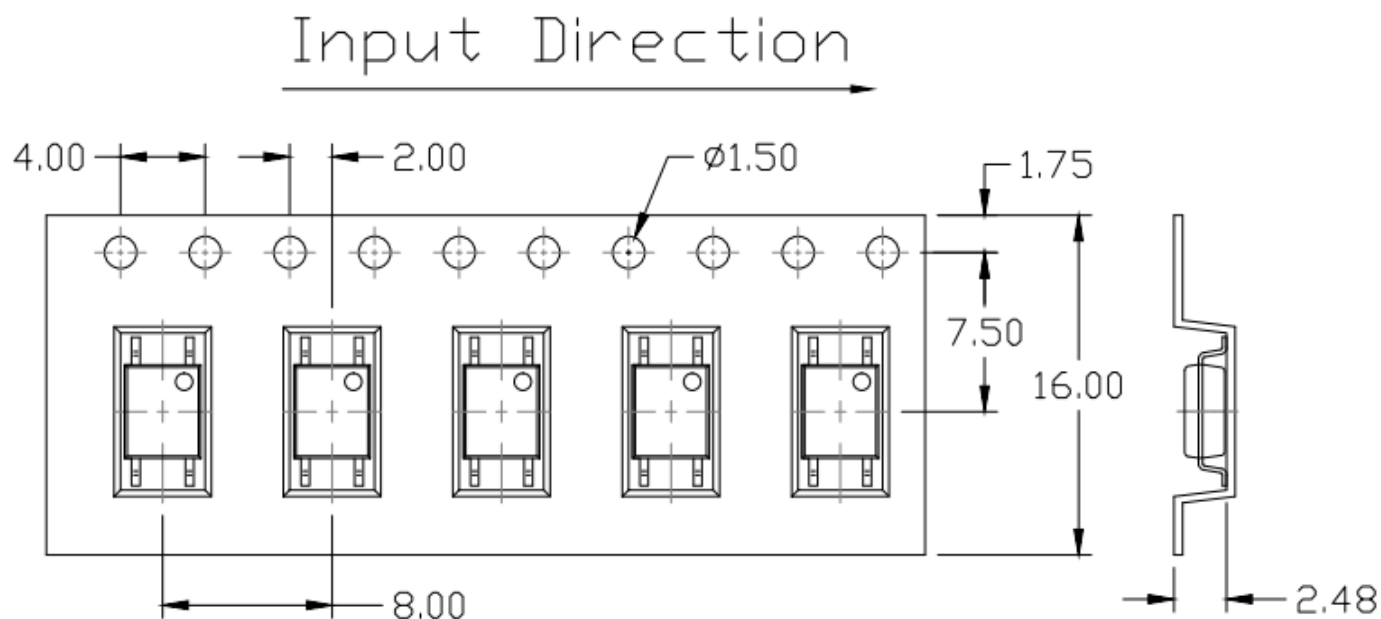

### Option (T2)

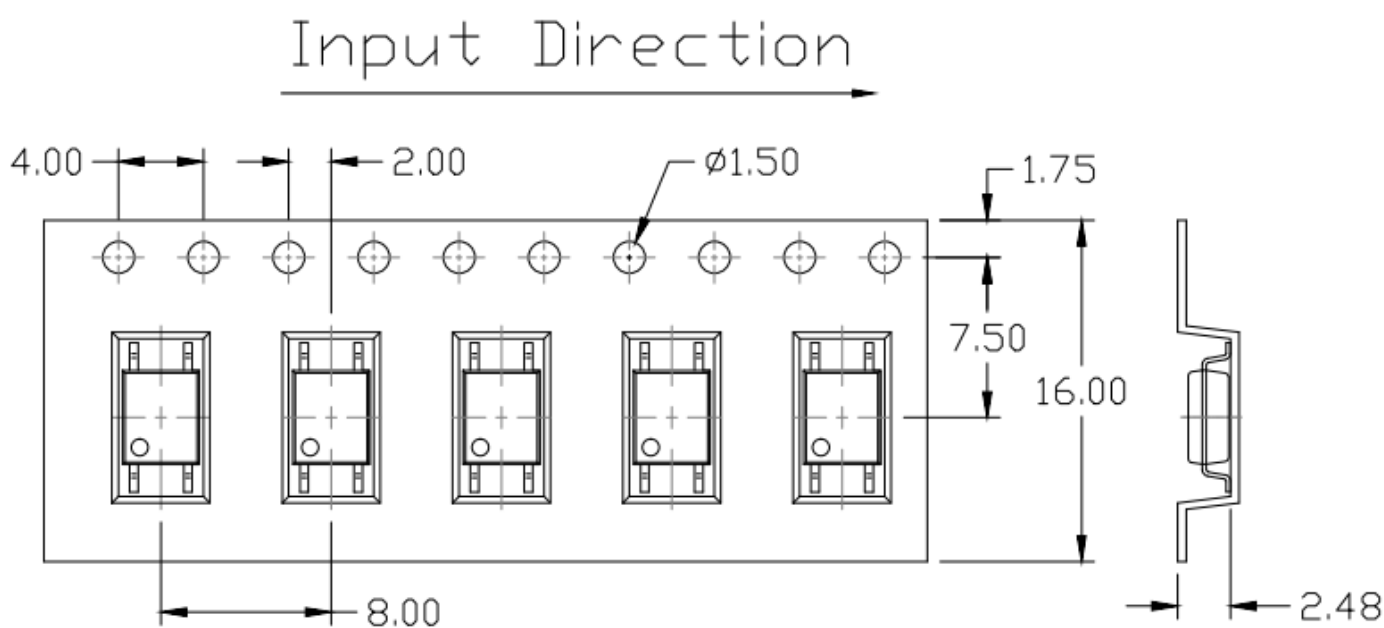



# CT354 Series AC Input 4-Pin Mini-Flat DMC-Isolator<sup>®</sup> Phototransistor Optocoupler

## Solderability Specification (follow the JEDEC standard JESD22-B102)

Reflow Soldering: Immersed surface, other than the end of pin as cut-surface, must be covered by solder.

Solder-Bath: More than 95% of the electrode must be covered with solder.

## Wave soldering (follow the JEDEC standard JESD22-A111)

One time soldering is recommended within the condition of temperature.

Temperature:  $260 \pm 0/-5^\circ\text{C}$ .

Time: 10 sec.

Preheat temperature: 25 to  $140^\circ\text{C}$ .

Preheat time: 30 to 80 sec.

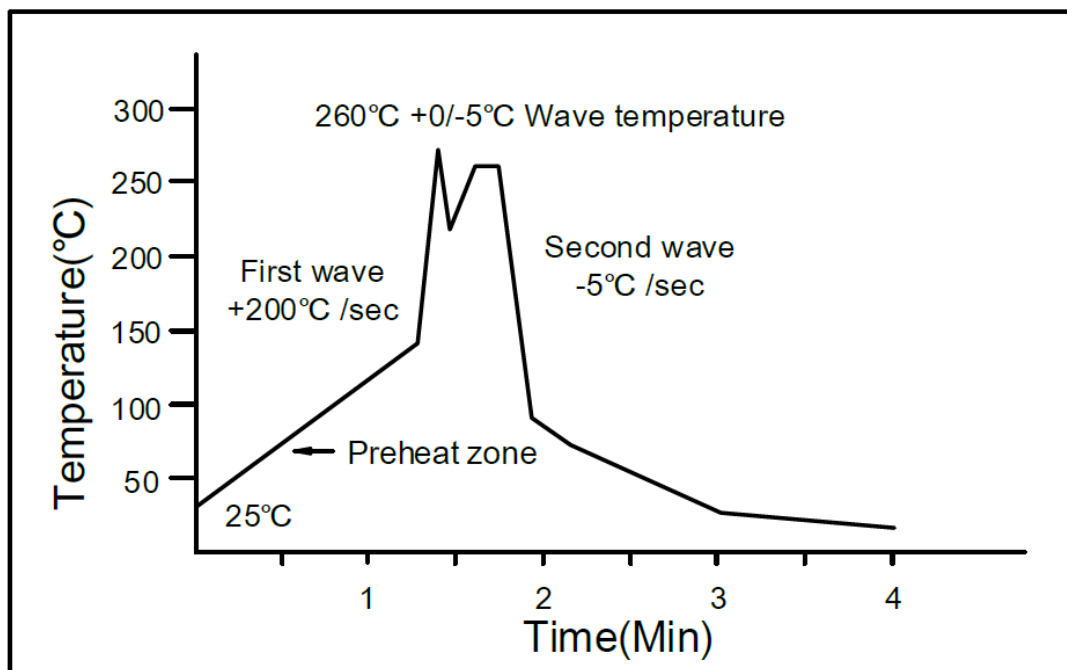

## Iron Soldering (follow the standard MIL-STD 202G, Method 210F)

Allow single lead soldering in every single process.

One time soldering is recommended.

Temperature:  $350 \pm 10^\circ\text{C}$

Time: 5 sec max.



Reflow Profile (Follow the JEDEC standard J-STD-020)

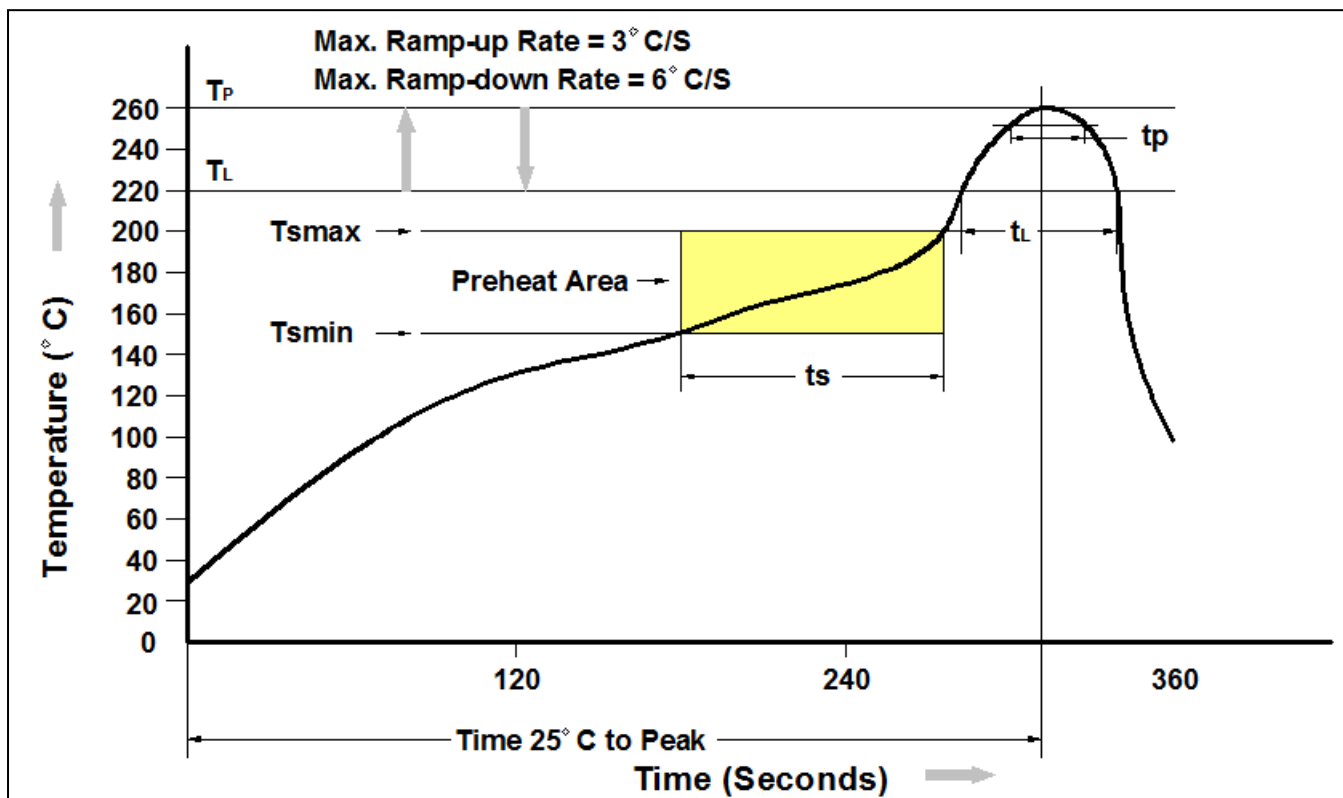

Profile Feature	Pb-Free Assembly Profile
Temperature Min. (T <sub>min</sub> )	150°C
Temperature Max. (T <sub>max</sub> )	200°C
Time (t <sub>s</sub> ) from (T <sub>min</sub> to T <sub>max</sub> )	60-120 seconds
Ramp-up Rate (t <sub>L</sub> to t <sub>P</sub> )	3°C/second max.
Liquidous Temperature (T <sub>L</sub> )	217°C
Time (t <sub>L</sub> ) Maintained Above (T <sub>L</sub> )	60 – 150 seconds
Peak Body Package Temperature	260°C +0°C / -5°C
Time (t <sub>P</sub> ) within 5°C of 260°C	30 seconds
Ramp-down Rate (T <sub>P</sub> to T <sub>L</sub> )	6°C/second max
Time 25°C to Peak Temperature	8 minutes max.



# CT354 Series AC Input 4-Pin Mini-Flat DMC-Isolator® Phototransistor Optocoupler

---

## DISCLAIMER

DMC-Isolator® IS A TRADEMARK OF CT MICRO INTERNATIONAL CORPORATION AND/OR ITS SUBSIDIARIES. CT MICRO OWNS THE RIGHTS TO A NUMBER OF PATENTS, TRADEMARKS, COPYRIGHTS AND OTHER INTELLECTUAL PROPERTY.

---

CT MICRO RESERVES THE RIGHT TO MAKE CHANGES WITHOUT FURTHER NOTICE TO ANY PRODUCTS HEREIN TO IMPROVE RELIABILITY, FUNCTION OR DESIGN. CT MICRO DOES NOT ASSUME ANY LIABILITY ARISING OUT OF THE APPLICATION OR USE OF ANY PRODUCT OR CIRCUIT DESCRIBED HEREIN; NEITHER DOES IT CONVEY ANY LICENSE UNDER ITS PATENT RIGHTS, NOR THE RIGHTS OF OTHERS.

---

COLOUR CHANGE MIGHT OCCUR ON THE PACKAGE SURFACE AFTER SOLDERING, REFLOW OR LONG TERM USE. THIS DOES NOT IMPACT THE PRODUCT PERFORMANCE NOR THE PRODUCT RELIABILITY.

---

CT MICRO ARE NOT AUTHORIZED FOR USE AS CRITICAL COMPONENTS IN LIFE SUPPORT DEVICES OR SYSTEMS WITHOUT EXPRESS WRITTEN APPROVAL OF CT MICRO INTERNATIONAL CORPORATION.

- 1. Life support devices or systems are devices or systems which, (a) are intended for surgical implant into the body, or (b) support or sustain life, or (c) whose failure to perform when properly used in accordance with instruction for use provided in the labelling, can be reasonably expected to result in significant injury to the user.*
- 2. A critical component is any component of a life support device or system whose failure to perform can be reasonably expected to cause the failure of the life support device or system, or to affect its safety or effectiveness.*

## X-ON Electronics

Largest Supplier of Electrical and Electronic Components

*Click to view similar products for* [Photodiode Output Optocouplers](#) *category:*

*Click to view products by* [CT Micro International](#) *manufacturer:*

Other Similar products are found below :

[TLP590B\(C,F\)](#) [TLP5214\(D4.E\(O](#) [TLP7820\(A-LF4.E\(O](#) [IS281](#) [APV2111V](#) [APV1121SX](#) [APV2111VY](#) [TLP190B\(TPR,U,C,F\)](#)  
[TLP3906\(TPL,E](#) [TLP591B\(C,F\)](#) [IS281GR](#) [APS1241S](#) [APS2241S](#) [APV1122AJ](#) [APV1122J](#) [APV2121SJ](#) [APV2121S](#) [TLP3906\(TPR,E\(O](#)  
[TLP3914\(TP15,F\)](#) [APV1121SJ](#) [NSL 32](#) [NSL-32SR3](#) [ASSR-V621-002E](#) [AQW214E2HAXL1](#) [QCPL-329J-500E](#) [TLP521-2XGBSMT&R](#)  
[TLP521-2SMT&R](#) [K20102B](#) [TLD](#) [KPS28320E](#) [TLD](#) [CTH214A\(T1\)](#) [CT354\(V\)\(T1\)](#) [LTV-1008-TP-G](#) [LTV-214-TP1-GR-G](#)  
[CTH217C\(V\)\(T1\)](#) [CYMOC3023S\(TP1\)](#) [CYMOC3041S\(TP1\)](#) [CYMOC3061S\(TP1\)](#) [CYMOC3083S\(TP1\)](#) [CYPC356\(C-TP\)](#) [CYPS2501-1\(L-](#)  
[TP2\)](#) [CYTLP127\(TP\)](#) [CYTLP291\(GB-TP\)](#) [KP10400E](#) [817B](#) [EL817M\(C\)-F](#) [K10103C](#) [KP40101C](#) [K30101A](#) [K30101C](#) [GX817MC](#)