

编码器规格书

ENCODER SPECIFICATIONS

1 一般事项 General information	
1-1 适用型号 Applicable models	ED08E 系列带开关型 ED08E Serial have Switch type
1-2 使用环境温度 Usage environment temperature	- 30℃ ~ + 70℃
1-3 保存环境温度 Storage environment temperature	- 40℃ ~ + 70℃
1-4 测试条件 Test condition	温度: 5~35℃, 湿度: 45~85%HR Temperature:5~35℃, Moisture:45~85%HR
1-5 环保要求 Environmental requisition	本产品符合 RoHS 指令 This product is compliant with RoHS Directive
1-6 耐焊接热 Soldering heat-resistance	1、手工焊接温度最高 350℃ ± 5℃, 3 秒; 2、自动焊接温度最高 260℃ ± 5℃, 3 秒; 基板表面预热温度最高 100℃, 1 分钟以内; 3、以上过程均保证在 1 到 2 次; 4、不适用回流焊。 1. Soldering iron Max ,350℃ ± 5℃ at 3 sec. 2. Auto soldering 260℃ ± 5℃ max. at 3 sec. Preheating temperature of board surface: 100℃ max. at within 1 minutes. 3. To guarantee the above process at 1 or 2 times. 4. No apply the reflow soldering.
1-7 原产地 Country of origin	中国 China
2 构造 Construction	
2-1 外观 Appearance	各部件应完整, 无锈蚀、裂痕、电镀不良 Every part should finished, be not exist rust flaw crack and bad plating
2-2 寸法 Measurements	依照图面规定 Under conditions prescribed by design drawing.
3 机械性能 Mechanical characteristics	
3-1 全回转角度 Total rotational angle	300° ± 5°
3-2 回转力矩 Rotational torque	70~400gf.cm (旋转速度: 60° /1 秒) 70~400gf.cm (Rotational velocity : 60° /1 Sec.)
3-3 回转止动强度 Rotational stopper strength	3Kgf.cm
3-4 定位数 Number of detent	14 个定位 14 Detents
3-5 切换角度 Change-Over angle	20° ± 3°
3-6 轴压引强度 Pull-Push Strength of Shaft	≥ 10Kgf
3-7 螺母锁紧强度 Nut tightening strength	≥ 10Kgf.cm
3-8 轴摇晃度 Shaft wobble	在单个轴顶端施加压力 250gf, 轴径向偏移量小于: 0.7*轴长 L 尺寸/30mm On the tip of the single shaft exert pressure 250gf , Shaft radial deviant be smaller than: 0.7*shaft long L size/30mm
4 电气性能 Electrical characteristics	
4-1 额定电压 Voltage rating	DC 5V

4-2 额定电流 Current rating	1mA
4-3 耐电压 Voltage proof	AC 300V 1 分钟以上（端子和本体之间，端子和轴芯之间） 1 Minute at AC 300V (Between terminal – case, Between terminal –shaft).
4-4 最大使用电流 Maximum operating current	2.5mA
4-5 绝缘抵抗 Insulation resistance	DC 250V 100M Ω 以上（端子和本体之间，端子和轴芯之间） 100M Ω min. At DC 250V (Between terminal – case, Between terminal –shaft).
4-6 回转寿命 Rotational life	无负荷情况下每小时旋转 600 周，寿命 30,000 周，寿命后： 1、绝缘抵抗 10M Ω 以上 DC250V（端子和本体之间，端子和轴芯之间）； 2、耐电压 AC100V 1 分钟（端子和本体之间，端子和轴芯之间），绝缘阻抗无击穿； 3、回转力矩：满足第 3-2 项； 4、外观和结构无损坏。 30,000 cycles under no load circumstances by 600 r/h of rotation, afterlife cycle: 1. Insulation resistance:10M Ω min. At DC 250V. (Between terminal – case, Between terminal –shaft). 2. Withstanding voltage : AC 100V at 1 minute (Between terminal – case, Between terminal –shaft). No subversion on insulation resistance. 3. Rotational torque : Content item No. 3-2. 4. No damage on appearance and structure.
5 开关的性能 Switch characteristics	
5-1 开关型式 Switch type	旋转式 Rotary type
5-2 开关回路 Switch configuration	单刀单掷 S.P.S.T
5-3 开关定格电力 Switch working angle	DC 16V-1A
5-4 开关工作角度 Switch working angle	50° max
5-5 开关工作力矩 Switch working torque	78.5mN.m (800gf.cm max)
5-6 开关接触电阻 Switch contact resistance	50 m Ω max 1000 m Ω max .after 30,000 cycles.
5-7 开关寿命 Switch life	无负荷 30, 000 周 30,000 cycles without load
6 防水性能 Waterproof standard characteristics	
6-1 防水标准 Waterproof standard	<input type="checkbox"/> 不适用 No Apply <input type="checkbox"/> 七级防水 编码器轴芯轴套置于水中 1 米深处，其它部件密封后暴露在标准大气压中，30 分钟后电位器内部未进水。 Grade -7 of Waterproof standard Encoder's Shaft and Bush in water 1M deep, after other component sealed exposed to the standard atmosphere, after 30 minutes no water into the Encoder's inner.
东莞市长泰尔电子有限公司 DONG GUAN CHANG TAI ER ELECTRONIC CO., LTD.	
	制作 Designed By
	审核 Checked By
	核准 Approved By

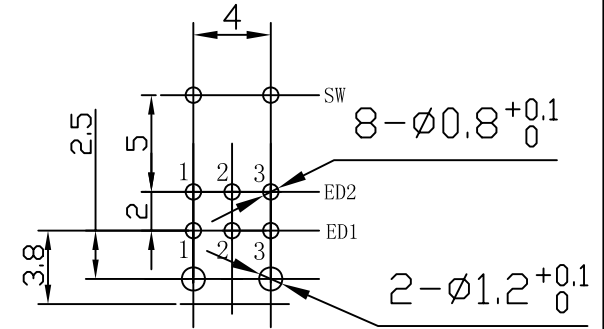
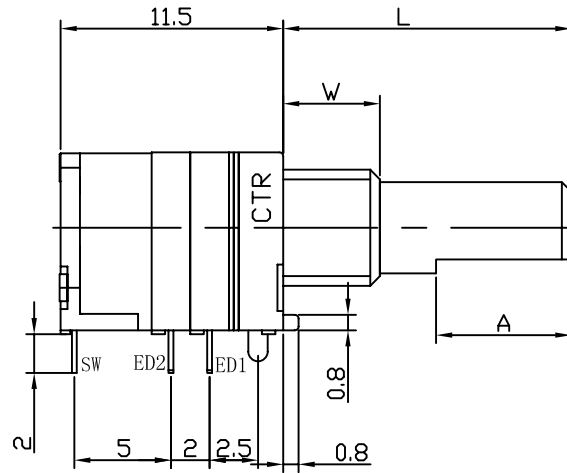
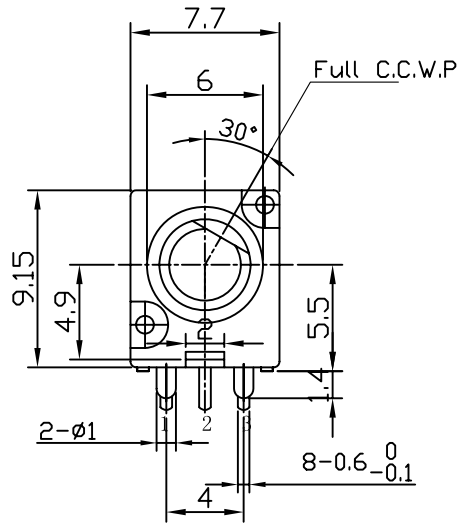
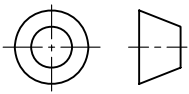

Mounting hole detail

product code	W	M
ED08E42S	5	M6X0.75
ED08E52S	7	
ED08E62S	10	

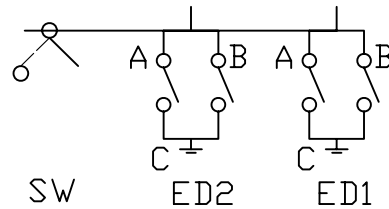
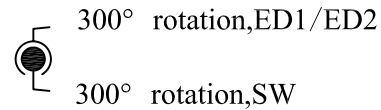

click position	C.W															
	1	2	3	4	5	6	7	8	9	10	11	12	13	14	15	16
ED1(1-2)	0	1	1	0	0	1	1	0	0	0	1	1	0	0	1	1
ED1(3-2)	1	0	0	0	1	1	0	0	0	1	1	0	0	1	1	0
ED2(1-2)	1	0	0	1	0	0	1	1	0	0	1	1	0	1	0	0
ED2(3-2)	0	0	1	1	1	1	0	0	0	0	1	1	1	1	0	0

FE Shaft Style

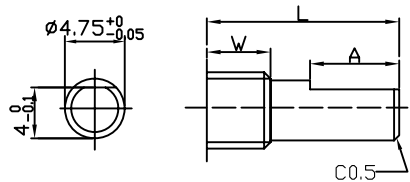

L	15	18					
A	7	9					

东莞市长泰尔电子有限公司

未注尺寸公差	比例	2.5:1	版本	1.1	设计	审核	批准	
L ≤ 1.0时 ±0.1	品名	ED08E□2S 组立图						
1.0 < L ≤ 10时 ±0.3								
10 < L ≤ 30时 ±0.5								
30 < L ≤ 100时 ±1.0	图号	ED08E□2S-□□□□□□□□-A16-1020						

X-ON Electronics

Largest Supplier of Electrical and Electronic Components

Click to view similar products for [Coded Rotary Switches](#) category:

Click to view products by [CTR](#) manufacturer:

Other Similar products are found below :

[PT65503RT](#) [Y36D02243FPLFT](#) [RTAP31S12WFLSP](#) [MADR-16H1](#) [GSER-10](#) [6KF001B-3S10R4-0](#) [EC11E153442W](#) [EC11E1534441](#) [SC-2110](#) [SD-2010TB](#) [MER-16H](#) [EDR-08](#) [USR-10](#) [FSR-08](#) [FSR-04S](#) [ESR-16](#) [HAMR-10S](#) [SDR-10H](#) [QSR-16H](#) [HAMR-16](#) [FDR-04S](#) [EDR-16S](#) [ESR-10S](#) [QDR-08H1](#) [EDR-08S](#) [ESR-16H](#) [QDR-10](#) [EDR-10S](#) [QSR-06S](#) [ESR-08S](#) [EC11E156040N](#) [EC11B15243DC](#) [EC35AH220501](#) [EC18AGB20406](#) [EC11E09244C3](#) [EC11G1534414](#) [EC11E156T402](#) [EC60A1520405](#) [EC11E1564454](#) [EC11J0925501](#) [EC11E15204B1](#) [EC11E1564439](#) [EC50A0920403](#) [ED103180-FE14.5S7.5-A16-1010](#) [ED08E42S-FE15C7.0-A16-1020](#) [ED08C030-FE18C9.0-A16-1002X](#) [ED08C210-FE18A6.0-A16-1002](#) [ED08C110-FE18S9.0-A16-1040](#) [ED08C150-BM20S6.0-A16-1026](#) [ED103010-SP17S8.0-A16-1012](#)