

电位器规格书

POTENTIOMETER SPECIFICATIONS

1 一般事项 General information	
1-1 适用型号 Applicable models	R087 系列 (普通寿命) R087 series (General life cycle)
1-2 使用环境温度 Usage environment temperature	- 20°C ~ + 70°C
1-3 保存环境温度 Storage environment temperature	- 40°C ~ + 70°C
1-4 测试条件 Test condition	温度: 5~35°C, 湿度: 45~85%HR Temperature: 5~35°C, Moisture: 45~85%HR
1-5 环保要求 Environmental requisition	本产品符合 RoHS 指令 This product is compliant with RoHS Directive
1-6 焊接条件 Conditions of soldering	1、手工焊接温度最高 350°C ± 5°C, 3 秒; Soldering iron Max ,350°C ± 5°C at 3 sec 2、自动焊接温度最高 265°C, 3 秒; 基板表面预热温度最高 100°C, 2 分内; Auto soldering 265°C max. at 3 Sec. Preheating temperature of board surface: 100°C max. at within 2 minutes. 3、以上过程均保证在 1 到 2 次。 To guarantee the above process at 1 or 2 times. 4、不适用回流焊。 No apply the reflow soldering.
1-7 原产地 Country of origin	中国 China
2 构造 Construction	
2-1 外观 Appearance	各部件应完整, 无锈蚀、裂痕、电镀不良 Every part should finished, be not exist rust flaw crack and bad plating
2-2 寸法 Measurements	依照图面规定 Under conditions prescribed by design drawing.
3 机械性能 Mechanical characteristics	
3-1 全回转角度 Total rotational angle	300° ± 10°
3-2 回转力矩 Rotational torque	10~150gf.cm (旋转速度: 60° /1 秒) 10~150gf.cm (Rotational velocity: 60° /1 Sec.)
3-3 回转止动强度 Rotational stopper strength	3Kgf.cm Min.
3-4 轴压引强度 Pull-Push Strength	8Kgf.cm Min.
3-5 螺母锁拉强度 Nut tightening strength	8Kgf.cm Min.
3-6 轴摇晃度 Shaft wobble	在单个轴芯顶端施加 250gf, 轴径向偏移量小于: 0.5*轴长 L 尺寸/30mm On the tip of the single shaft exert 250gf, Shaft radial deviant be smaller than: 0.5*shaft long L size/30mm
4 电气性能 Electrical characteristics	
4-1 全阻抗值 Total resistance	<u>10</u> KΩ ± 20%

4-2 残留阻抗值 (端子: 1-2, 2-3) End resistance(Terminal :1-2, 2-3)	$R \leq 10K \Omega : \leq 10 \Omega ; \quad 10K \Omega < R \leq 250K \Omega : \leq 20 \Omega ; \quad R > 250K \Omega : \leq 0.1\%R$			
4-3 阻抗变化特性 Resistance	<input checked="" type="checkbox"/> A <input type="checkbox"/> B <input type="checkbox"/> C <input type="checkbox"/> _____			
4-4 定格电力 Ratings power	B 线性: 0.05W, 其它线性: 0.025W B Taper : 0.05W, Other taper : 0.025W			
4-5 最高使用电压 Maximum operating voltage	B 线性: 10V DC 或 50V AC, 其它线性: 5V DC 或 25V AC B Taper :10V AC or 50V AC, Other taper : 5V DC or 25V AC			
4-6 滑动杂音 Slider noise	100mV 以下 100mV Max.			
4-7 绝缘抵抗 Insulation resistance	250V DC, 100M Ω 以上 100M Ω Min. at 250V DC			
4-8 耐电压 Voltage proof	300V AC 1 分钟以上 1 Minute at 300V AC			
4-9 回转寿命 Rotational life	无负荷状态以每小时 600 周旋转, 寿命 10,000 周, 寿命后允许阻值最大变化 $\pm 15\%$ 。 15,000 cycles under no load circumstances by 600 r./h of rotation, afterlife cycle permissible resistance change $\pm 15\%$ maximum .			
5 开关性能 Switch characteristics				
<input checked="" type="checkbox"/> 适用 <input type="checkbox"/> 不适用 Apply No apply				
5-1 开关型式 Switch type	旋转式 Rotary type			
5-2 开关回路 Switch circuit	单极单投 S. P. S. T			
5-3 开关定格电力 Switch ratings power	12V DC 1A			
5-4 开关接触电阻 Switch contact resistance	$\leq 100 m \Omega$, 寿命后 $\leq 500 m \Omega$ $\leq 100 m \Omega$, $\leq 500 m \Omega$ of afterlife cycle.			
5-5 开关工作角度 Switch working angle	$50^\circ \pm 10^\circ$			
5-6 开关工作力矩 Switch working torque	120~250gf.cm			
5-7 开关寿命 Switch life	10,000 Cycles			
6 防水性能 Waterproof standard characteristics				
6-1 防水标准 Waterproof standard	<input checked="" type="checkbox"/> 不适用 No Apply <input type="checkbox"/> 七级防水 编码器轴芯轴套置于水中 1 米深处, 其它部件密封后暴露在标准大气压中, 30 分钟后电位器内部未进水。 Grade -7 of Waterproof standard Potentiometer's Shaft and Bush in water 1M deep, after other component sealed exposed to the standard atmosphere, after 30 minutes no water into the potentiometer's inner.			
东莞市长泰尔电子有限公司 DONG GUAN CHANG TAI ER ELECTRONIC CO., LTD.		制作 Designed By	审核 Checked By	核准 Approved By

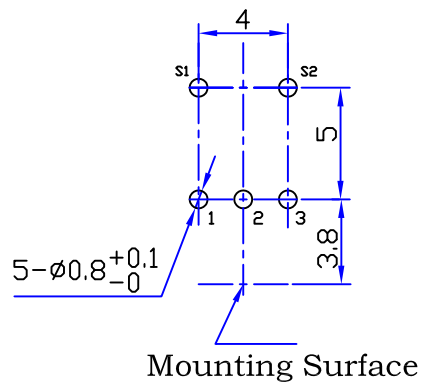
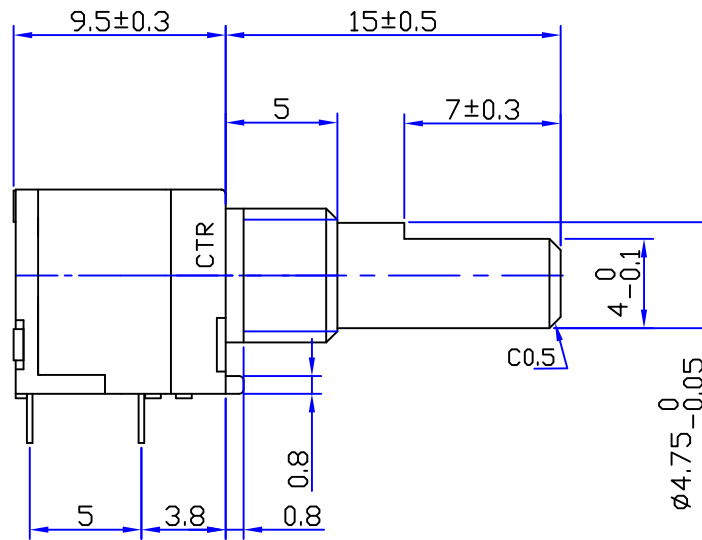
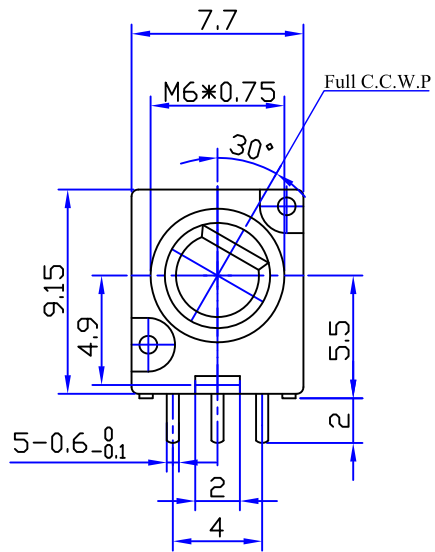

CIRCUIT :NS

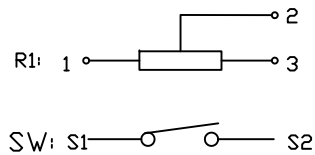

▽			
▽			
▽			
▽			
▽			
标记	变更内容	改图	日期

未注尺寸公差		东莞市长泰尔电子有限公司					
L≤1.0时 ±0.1		视角	制图	喻 钊	出图日	2023-03-21	
1.0<L≤10时 ±0.3		比例	3:1	单位	mm		
10<L≤30时 ±0.5		版本	1.0	设计	审核	批准	
30<L≤100时 ±1.0		品名		R08719NS 组立图			
图号		R08719NS-FE15D7.0					

东莞市长泰尔电子有限公司

DONG GUAN CHANG TAIER ELECTRONIC CO., LTD

阻抗变化特性 Resistance tapers

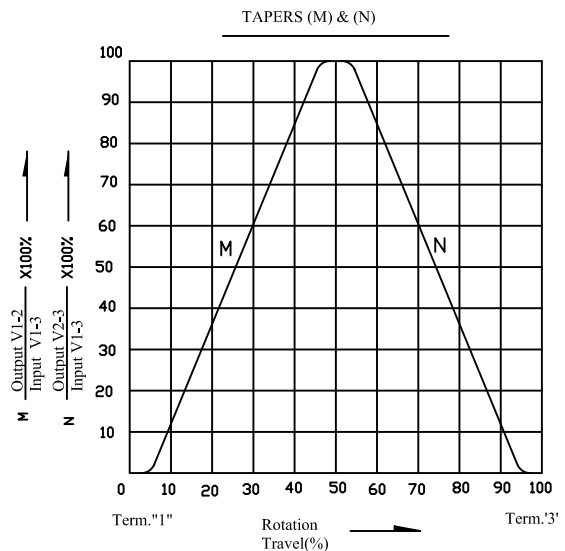
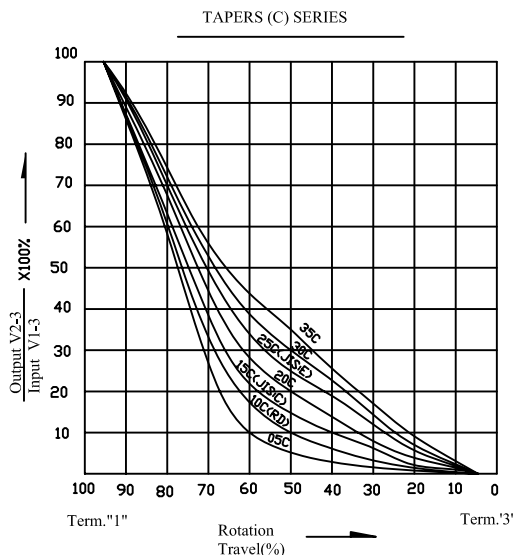
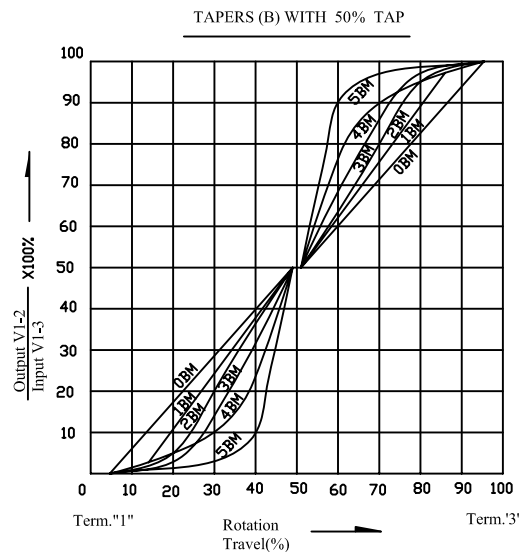
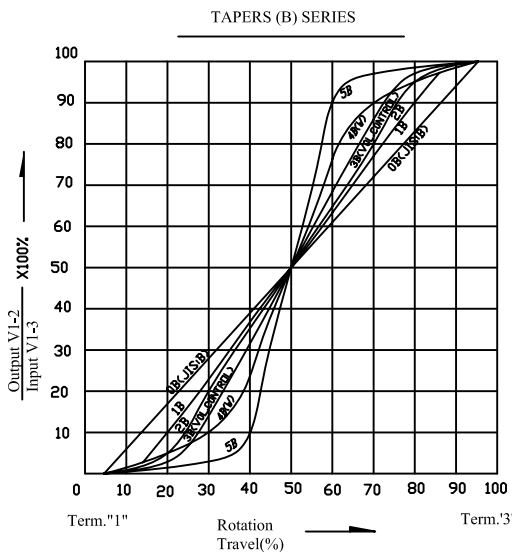
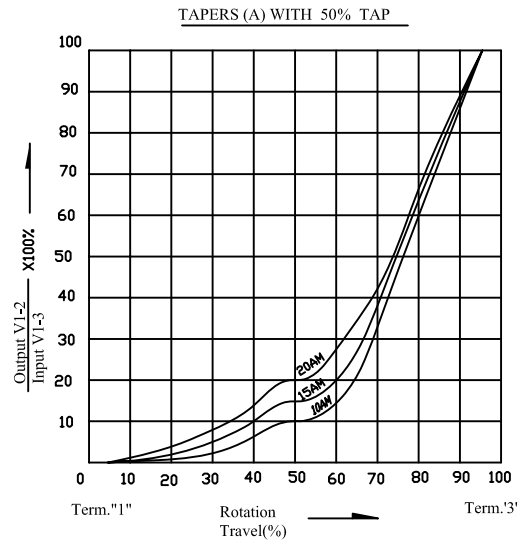
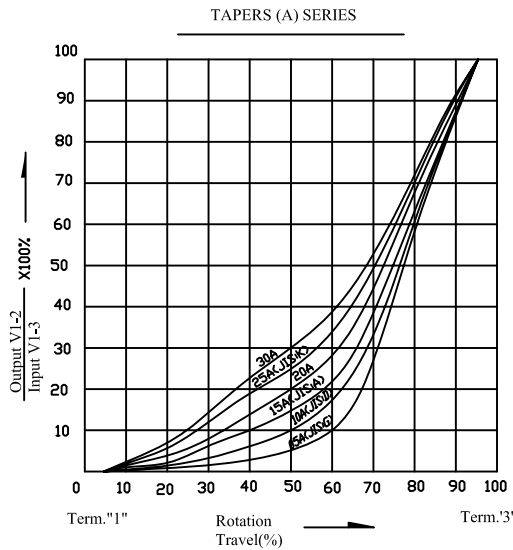

X-ON Electronics

Largest Supplier of Electrical and Electronic Components

Click to view similar products for [Potentiometers](#) category:

Click to view products by [CTR](#) manufacturer:

Other Similar products are found below :

[580SX4Q25F102SP](#) [580SX4Q25F103ZP](#) [58C2-2](#) [590SX1N32F103SS](#) [591SXJ48S252SC](#) [591SXP56S252SC](#) [591SXP56S503SC](#) [D31409](#)
[70B1G048K502X-A](#) [70B1M032S502W](#) [70B1N056S202W](#) [70B8N056F502W](#) [70J8N048S104U](#) [70L1N040P103W](#) [70L1N048P103X](#)
[70L1N048S103W](#) [GA2G056S101UA](#) [GA2G056S251UA](#) [GA2G056S501UA](#) [GA2L040S102UC](#) [GA2L040S103UC](#) [GA2L040S501UC](#)
[GS1G044P103UA](#) [GS1T032S103UA](#) [A43-1500](#) [A43-20K](#) [A47-200K](#) [A4720K](#) [RK14K1220-F25-C0-A103](#) [RK14K1220F25C0C104](#)
[RK14K1220-F25-C1-B103](#) [14910FBGLFY00103KA](#) [C0342008 5K](#) [J97589](#) [RV170F-10-15R1-B500K-0021](#) [917523A](#) [A43-40](#) [A43-750](#)
[A43S-5](#) [A47-15K](#) [A47-1K](#) [A4750K](#) [SPPG056P103U](#) [SWE-10](#) [GA2G040F103BA](#) [GA2G056S503UA](#) [GA2G056S504UA](#) [GA2L040S502UC](#)
[GA2L040S503UC](#) [POT-3217-02 \(MW22S-3217-500\)](#)