

电位器规格书

POTENTIOMETER SPECIFICATIONS

1 一般事项 General information	
1-1 适用型号 Applicable models	R095、R096、R097、R098、R09J、R09P、R09B 系列 R095/R096/R097/R098/R09J/R09P/R09B Serial
1-2 使用环境温度 Usage environment temperature	<input checked="" type="checkbox"/> - 10℃ ~ + 70℃ <input type="checkbox"/> - 20℃ ~ + 70℃
1-3 保存环境温度 Storage environment temperature	- 40℃ ~ + 85℃
1-4 测试条件 Test condition	温度: 5~35℃, 湿度: 45~85%HR Temperature: 5~35℃, Moisture: 45~85%HR
1-5 环保要求 Environmental requisition	本产品符合 RoHS 指令 This product is compliant with RoHS Directive
1-6 耐焊接热 Soldering heat-resistance	1、手工焊接温度最高 350℃ ± 5℃, 3 秒; 2、自动焊接温度最高 260℃ ± 5℃, 3 秒; 基板表面预热温度最高 100℃, 1 分钟以内; 3、以上过程均保证在 1 到 2 次。 1. Soldering iron Max ,350℃ ± 5℃ at 3 sec 2. Auto soldering 260℃ ± 5℃ max. at 3 Sec. Preheating temperature of board surface: 100℃ max. at within 1 minutes. 3. To guarantee the above process at 1 or 2 times.
1-7 原产地 Country of origin	中国 China
2 构造 Construction	
2-1 外观 Appearance	各部件应完整, 无锈蚀、裂痕、电镀不良 Every part should finished, not exist rust flaw crack and bad plating
2-2 寸法 Measurements	依照图面规定 Under conditions prescribed by design drawing.
3 机械性能 Mechanical characteristics	
3-1 全回转角度 Total rotational angle	<input checked="" type="checkbox"/> 300° ± 10° <input type="checkbox"/> _____
3-2 回转力矩 Rotational torque	10~200gf.cm (旋转速度: 60° /1 秒) 10~200gf.cm (Rotational velocity : 60° /1 Sec.)
3-3 CC 脱出力 Detent torque	80~250gf.cm
3-4 CC 点数 Detent quantity	<input checked="" type="checkbox"/> 0 <input type="checkbox"/> 1 <input type="checkbox"/> 21 <input type="checkbox"/> 41 <input type="checkbox"/> _____
3-5 回转止动强度 Rotational stopper strength	<input checked="" type="checkbox"/> ≥ 3Kgf.cm <input type="checkbox"/> ≥ 8Kgf.cm <input type="checkbox"/> ≥ 4Kgf.cm <input type="checkbox"/> ≥ 5Kgf.cm
3-6 轴压引强度 Pull-Push Strength of Shaft	<input checked="" type="checkbox"/> ≥ 8Kgf <input type="checkbox"/> ≥ 10Kgf
3-7 螺母锁紧强度 Nut tightening strength	≥ 10Kgf.cm
3-8 轴摇晃度 Shaft wobble	在单个轴芯顶端施加 250gf, 轴径向偏移量小于: 0.7*轴长 L 尺寸/20mm On the tip of the single shaft exert 250gf , Shaft radial deviant be smaller than: 0.7*shaft long L size/20mm
4 电气性能 Electrical characteristics	
4-1 全阻抗值 Total resistance	<input checked="" type="checkbox"/> 10 KΩ ± 20% <input type="checkbox"/> _____ KΩ ± 10% <input type="checkbox"/> _____ KΩ + _____ % / - _____ %
4-2 阻抗变化特性 Resistance taper	<input type="checkbox"/> A <input checked="" type="checkbox"/> B <input type="checkbox"/> C <input type="checkbox"/> _____

4-3 残留阻抗值 (端子: 1-2, 2-3) End resistance (Terminal :1-2, 2-3)	$R \leq 10K \Omega : \leq 10 \Omega ; \quad 10K \Omega < R \leq 250K \Omega : \leq 20 \Omega ; \quad R > 250K \Omega : \leq 0.1\%R$		
4-4 定格电力 Ratings power	B 线性: 0.05W, 其它线性: 0.025W B Taper : 0.05W, Other taper : 0.025W		
4-5 最高使用电压 Maximum operating voltage	B 线性: 20V DC 或 50V AC, 其它线性: 12V DC 或 25V AC B Taper : 20V AC or 50V AC, Other taper : 12V DC or 25V AC		
4-6 滑动杂音 Slider noise	<100mV		
4-7 同步误差 Gang error	<input type="checkbox"/> $\pm 4dB (-40dB \sim 0dB)$ <input type="checkbox"/> $\pm 3dB (-40dB \sim 0dB)$ *只适用于双联 *Apply the Dual-Unit only		
4-8 绝缘抵抗 Insulation resistance	250V DC, >100M Ω		
4-9 耐电压 Voltage proof	300V AC 1 分钟以上 1 Minute at 300V AC		
4-10 回转寿命 Rotational life	<input checked="" type="checkbox"/> 10,000 cycles <input type="checkbox"/> 15,000 cycles <input type="checkbox"/> 30,000 cycles 注: 无负荷状态以每小时 600 周旋转, 允许阻值最大变化 $\pm 15\%$ 。 On the without load status according to the 600 r./h rotation, permissible resistance change $\pm 15\%$ max.		
5 开关性能 Switch characteristics			
<input type="checkbox"/> 适用 <input checked="" type="checkbox"/> 不适用 Apply No apply			
5-1 开关型式 Switch type	<input type="checkbox"/> 旋转式 <input type="checkbox"/> 按压复位式 Rotate type Push-Push type		
5-2 开关回路 Switch circuit	单极单投 S.P.S.T		
5-3 开关定格电力 Switch ratings power	旋转开关: 12V DC 1A 按压复位开关: 12V DC 0.5A Rotate switch: 12V DC 1A Push-Push switch: 12V DC 0.5A		
5-4 开关接触电阻 Switch contact resistance	寿命初期: 100 m Ω 最大, 开关 10,000 次以后: 最大 1 Ω The life initial stage: 100 m Ω max., after on-off 10,000 cycles: 1 Ω max.		
5-5 开关工作角度或行程 Switch working angle or track	旋转开关: $50^\circ \pm 10^\circ$ 按压复位开关行程: 0.5mm 或 1.5mm, 具体参照图纸 Rotate switch: $50^\circ \pm 10^\circ$. Push-Push switch track: 0.5mm or 1.5mm, specific reference to the drawing.		
5-6 开关工作力矩 Switch working torque	旋转开关: 最大 800gf.cm 按压开关: 700 \pm 300gf Rotate switch: 800gf.cm max. Push-Push switch: 700 \pm 300gf		
5-7 开关寿命 Switch life	10,000 cycles		
6 防水性能 Waterproof characteristics			
6-1 防水标准 Waterproof standard	<input checked="" type="checkbox"/> 不适用 No apply <input type="checkbox"/> 七级防水 电位器轴芯轴套置于水中 1 米深处, 其它部件密封后暴露在标准大气压中, 30 分钟后电位器内部未进水。 Grade -7 of Waterproof standard Potentiometer's Shaft and Bush in 1M deep of water, other component sealed after be exposed to the standard atmosphere, after 30 minutes no water into the Potentiometer' inner.		
东莞市长泰尔电子有限公司 DONG GUAN CHANG TAI ER ELECTRONIC CO., LTD.		制作 Designed By	审核 Checked By
		核准 Approved By	

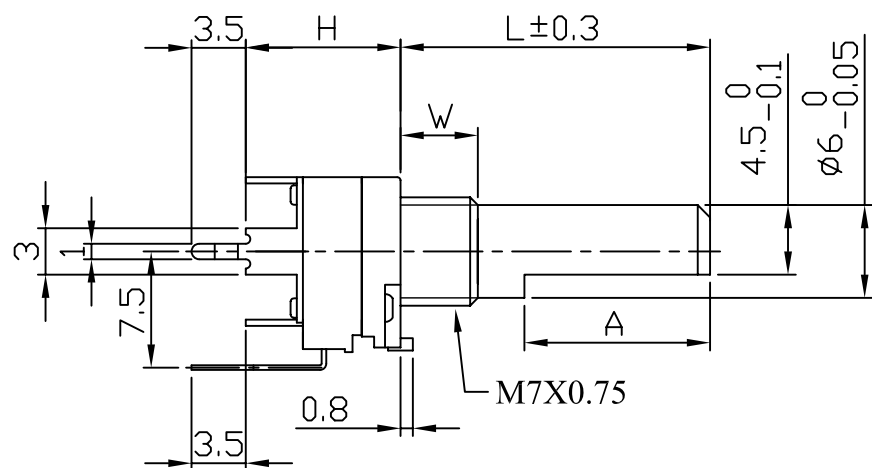
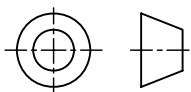

Full.C.C.W position

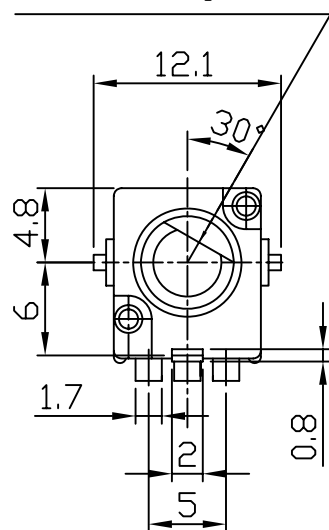

Mounting hole detail

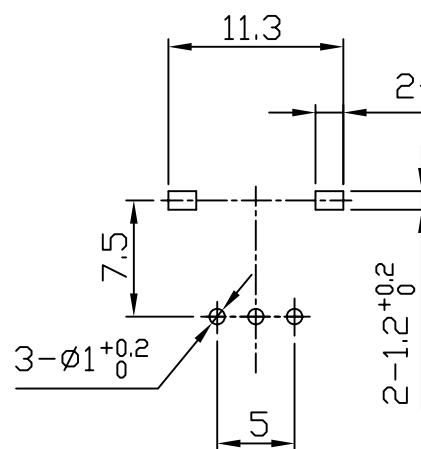

CIRCUIT:NO

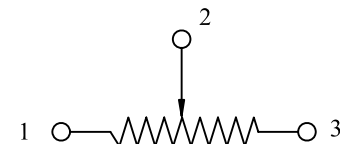

轴的类型:

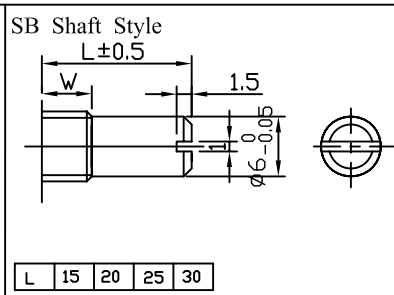
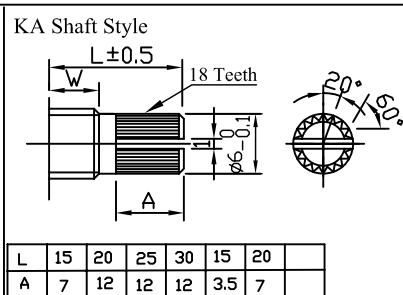
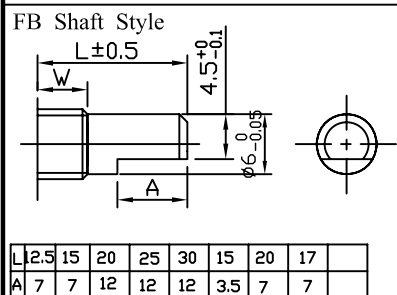

product code	W	H
R09512NO	5	10
R09522NO	7	10
R09532NO	10	10
R09542NO	5	7.5
R09552NO	7	7.5
R09562NO	10	7.5

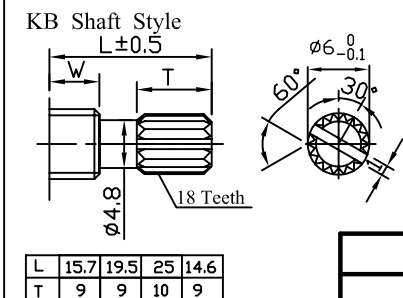
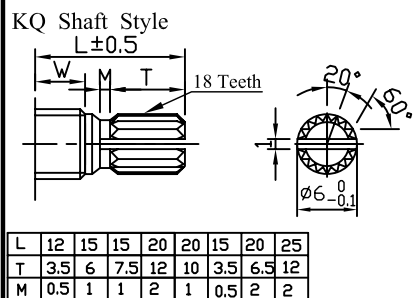
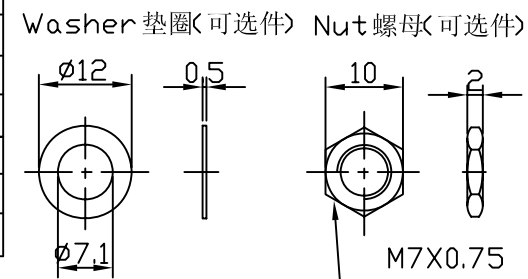

东莞市长泰尔电子有限公司

未注尺寸公差	比例	2:1	版本	1.2	设计	审核	批准
L ≤ 1.0时 ±0.1	品名	R095□2NO 组立图					
1.0 < L ≤ 10时 ±0.3							
10 < L ≤ 30时 ±0.5							
30 < L ≤ 100时 ±1.0	图号	R095□2NO-					

东莞市长泰尔电子有限公司

DONG GUAN CHANG TAIER ELECTRONIC CO., LTD

阻抗变化特性 Resistance tapers

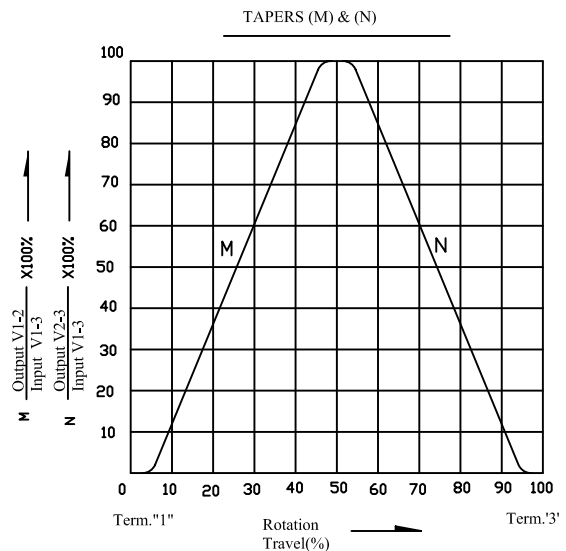
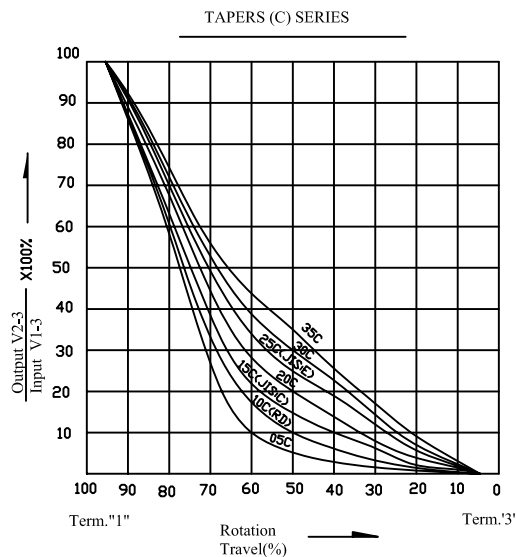
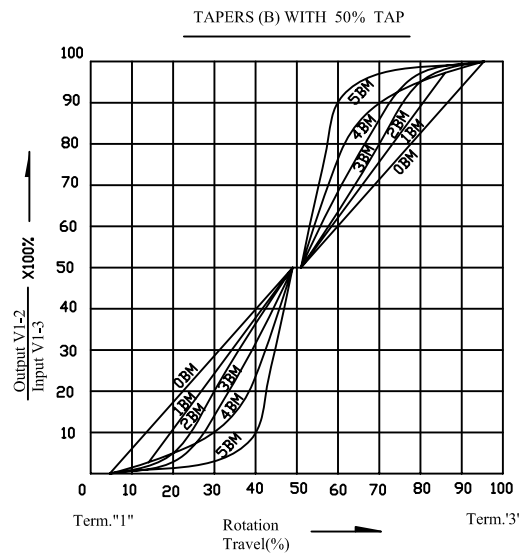
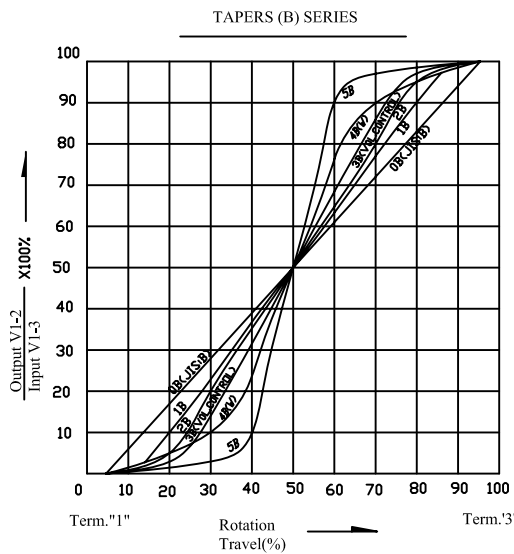
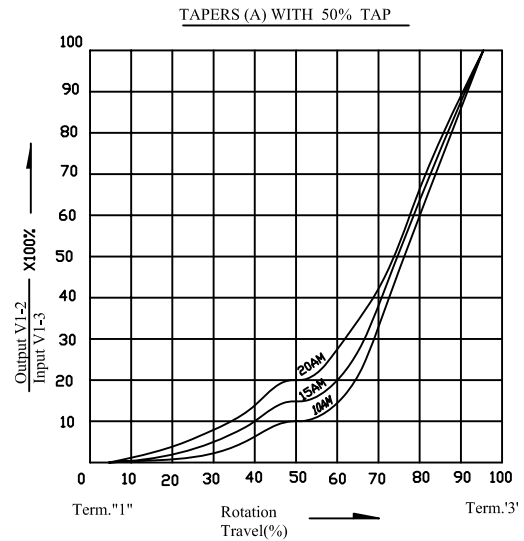
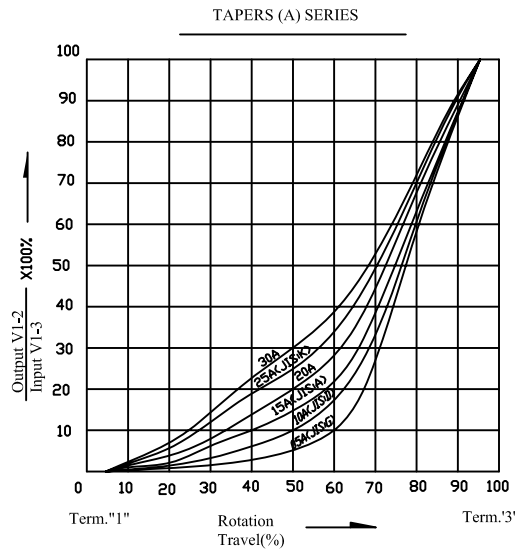

X-ON Electronics

Largest Supplier of Electrical and Electronic Components

Click to view similar products for [Potentiometers](#) category:

Click to view products by [CTR](#) manufacturer:

Other Similar products are found below :

[580SX4Q25F102SP](#) [580SX4Q25F103ZP](#) [58C2-2](#) [590SX1N32F103SS](#) [591SXJ48S252SC](#) [591SXP56S252SC](#) [591SXP56S503SC](#) [D31409](#)
[70B1G048K502X-A](#) [70B1M032S502W](#) [70B1N056S202W](#) [70B8N056F502W](#) [70J8N048S104U](#) [70L1N040P103W](#) [70L1N048P103X](#)
[70L1N048S103W](#) [GA2G056S101UA](#) [GA2G056S251UA](#) [GA2G056S501UA](#) [GA2L040S102UC](#) [GA2L040S103UC](#) [GA2L040S501UC](#)
[GS1G044P103UA](#) [GS1T032S103UA](#) [A43-1500](#) [A43-20K](#) [A47-200K](#) [A4720K](#) [RK14K1220-F25-C0-A103](#) [RK14K1220F25C0C104](#)
[RK14K1220-F25-C1-B103](#) [14910FBGLFY00103KA](#) [C0342008 5K](#) [J97589](#) [RV170F-10-15R1-B500K-0021](#) [917523A](#) [A43-40](#) [A43-750](#)
[A43S-5](#) [A47-15K](#) [A47-1K](#) [A4750K](#) [SPPG056P103U](#) [SWE-10](#) [GA2G040F103BA](#) [GA2G056S503UA](#) [GA2G056S504UA](#) [GA2L040S502UC](#)
[GA2L040S503UC](#) [POT-3217-02 \(MW22S-3217-500\)](#)