

# 电位器规格书

## POTENTIOMETER SPECIFICATIONS

<b>1 一般事项</b> <b>General information</b>	
1-1 适用型号 Applicable models	R095、R096、R097、R098、R09J、R09P、R09B 系列 R095/R096/R097/R098/R09J/R09P/R09B Serial
1-2 使用环境温度 Usage environment temperature	<input type="checkbox"/> - 10℃ ~ + 70℃ <input checked="" type="checkbox"/> - 20℃ ~ + 70℃
1-3 保存环境温度 Storage environment temperature	- 40℃ ~ + 85℃
1-4 测试条件 Test condition	温度：5~35℃，湿度：45~85%HR Temperature:5~35℃, Moisture:45~85%HR
1-5 环保要求 Environmental requisition	本产品符合 RoHS 指令 This product is compliant with RoHS Directive
1-6 耐焊接热 Soldering heat-resistance	1、手工焊接温度最高 350℃ ± 5℃，3 秒； 2、自动焊接温度最高 260℃ ± 5℃，3 秒；基板表面预热温度最高 100℃，1 分钟以内； 3、以上过程均保证在 1 到 2 次。  1. Soldering iron Max ,350℃ ± 5℃ at 3 sec 2. Auto soldering 260℃ ± 5℃ max. at 3 Sec. Preheating temperature of board surface: 100℃ max. at within 1 minutes. 3. To guarantee the above process at 1 or 2 times.
1-7 原产地 Country of origin	中国 China
<b>2 构造</b> <b>Construction</b>	
2-1 外观 Appearance	各部件应完整，无锈蚀、裂痕、电镀不良 Every part should finished, not exist rust flaw crack and bad plating
2-2 寸法 Measurements	依照图面规定 Under conditions prescribed by design drawing.
<b>3 机械性能</b> <b>Mechanical characteristics</b>	
3-1 全回转角度 Total rotational angle	<input checked="" type="checkbox"/> 300° ± 10° <input type="checkbox"/> _____
3-2 回转力矩 Rotational torque	10~200gf.cm (旋转速度：60° /1 秒) 10~200gf.cm (Rotational velocity : 60° /1 Sec. )
3-3 CC 脱出力 Detent torque	80~250gf.cm
3-4 CC 点数 Detent quantity	<input checked="" type="checkbox"/> 0 <input type="checkbox"/> 1 <input type="checkbox"/> 21 <input type="checkbox"/> 41 <input type="checkbox"/> _____
3-5 回转止动强度 Rotational stopper strength	<input checked="" type="checkbox"/> ≥3Kgf.cm <input type="checkbox"/> ≥8Kgf.cm <input type="checkbox"/> ≥4Kgf.cm <input type="checkbox"/> ≥5Kgf.cm
3-6 轴压引强度 Pull-Push Strength of Shaft	<input checked="" type="checkbox"/> ≥8Kgf <input type="checkbox"/> ≥10Kgf
3-7 螺母锁紧强度 Nut tightening strength	≥10Kgf.cm
3-8 轴摇晃度 Shaft wobble	在单个轴芯顶端施加 250gf，轴径向偏移量小于：0.7*轴长 L 尺寸/20mm On the tip of the single shaft exert 250gf , Shaft radial deviant be smaller than: 0.7*shaft long L size/20mm
<b>4 电气性能</b> <b>Electrical characteristics</b>	
4-1 全阻抗值 Total resistance	<input checked="" type="checkbox"/> _____ KΩ ± 20% <input type="checkbox"/> _____ KΩ ± 10% <input type="checkbox"/> _____ KΩ + _____%/- _____%
4-2 阻抗变化特性 Resistance taper	<input type="checkbox"/> A <input checked="" type="checkbox"/> B <input type="checkbox"/> C <input type="checkbox"/> _____

4-3 残留阻抗值 (端子: 1-2, 2-3) End resistance (Terminal :1-2, 2-3)	$R \leq 10K \Omega : \leq 10 \Omega ; \quad 10K \Omega < R \leq 250K \Omega : \leq 20 \Omega ; \quad R > 250K \Omega : \leq 0.1\%R$		
4-4 定格电力 Ratings power	B 线性: 0.05W, 其它线性: 0.025W B Taper : 0.05W, Other taper : 0.025W		
4-5 最高使用电压 Maximum operating voltage	B 线性: 20V DC 或 50V AC, 其它线性: 12V DC 或 25V AC B Taper : 20V AC or 50V AC, Other taper : 12V DC or 25V AC		
4-6 滑动杂音 Slider noise	<100mV		
4-7 同步误差 Gang error	<input type="checkbox"/> $\pm 4dB (-40dB \sim 0dB)$ <input type="checkbox"/> $\pm 3dB (-40dB \sim 0dB)$ *只适用于双联 *Apply the Dual-Unit only		
4-8 绝缘抵抗 Insulation resistance	250V DC, >100M $\Omega$		
4-9 耐电压 Voltage proof	300V AC 1 分钟以上 1 Minute at 300V AC		
4-10 回转寿命 Rotational life	<input checked="" type="checkbox"/> 10,000 cycles <input type="checkbox"/> 15,000 cycles <input type="checkbox"/> 30,000 cycles 注: 无负荷状态以每小时 600 周旋转, 允许阻值最大变化 $\pm 15\%$ 。 On the without load status according to the 600 r./h rotation, permissible resistance change $\pm 15\%$ max.		
<b>5 开关性能</b> <b>Switch characteristics</b>			
<input checked="" type="checkbox"/> 适用 <input type="checkbox"/> 不适用 Apply                              No apply			
5-1 开关型式 Switch type	<input checked="" type="checkbox"/> 旋转式 <input type="checkbox"/> 按压复位式 Rotate type                      Push-Push type		
5-2 开关回路 Switch circuit	单极单投 S.P.S.T		
5-3 开关定格电力 Switch ratings power	旋转开关: 12V DC 1A                      按压复位开关: 12V DC 0.5A Rotate switch: 12V DC 1A                      Push-Push switch: 12V DC 0.5A		
5-4 开关接触电阻 Switch contact resistance	寿命初期: 100 m $\Omega$ 最大, 开关 10,000 次以后: 最大 1 $\Omega$ The life initial stage: 100 m $\Omega$ max., after on-off 10,000 cycles: 1 $\Omega$ max.		
5-5 开关工作角度或行程 Switch working angle or track	旋转开关: 50° $\pm$ 10° 按压复位开关行程: 0.5mm 或 1.5mm, 具体参照图纸 Rotate switch: 50° $\pm$ 10° . Push-Push switch track: 0.5mm or 1.5mm, specific reference to the drawing.		
5-6 开关工作力矩 Switch working torque	旋转开关: 最大 800gf.cm                      按压开关: 700 $\pm$ 300gf Rotate switch: 800gf.cm max.                      Push-Push switch: 700 $\pm$ 300gf		
5-7 开关寿命 Switch life	10,000 cycles		
<b>6 防水性能</b> <b>Waterproof characteristics</b>			
6-1 防水标准 Waterproof standard	<input checked="" type="checkbox"/> 不适用 No apply  <input type="checkbox"/> 七级防水 电位器轴芯轴套置于水中 1 米深处, 其它部件密封后暴露在标准大气压中, 30 分钟后电位器内部未进水。 Grade -7 of Waterproof standard Potentiometer's Shaft and Bush in 1M deep of water, other component sealed after be exposed to the standard atmosphere, after 30 minutes no water into the Potentiometer' inner.		
<b>东莞市长泰尔电子有限公司</b> <b>DONG GUAN CHANG TAI ER ELECTRONIC CO., LTD.</b>		制作 Designed By	审核 Checked By
		核准 Approved By	

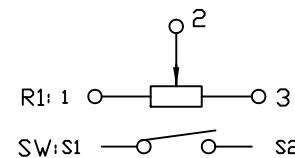
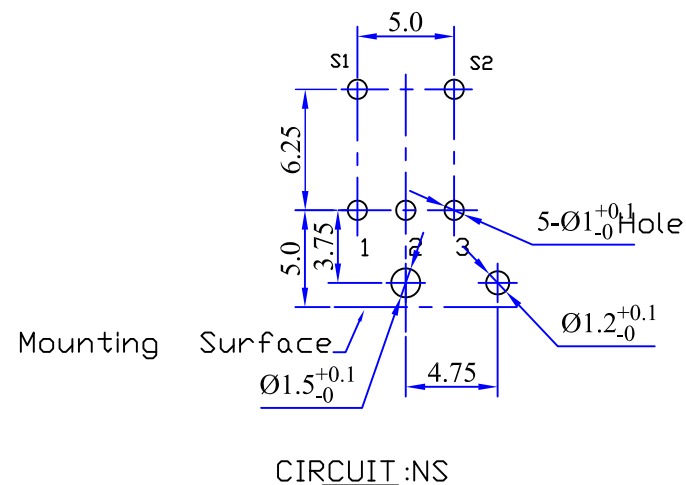
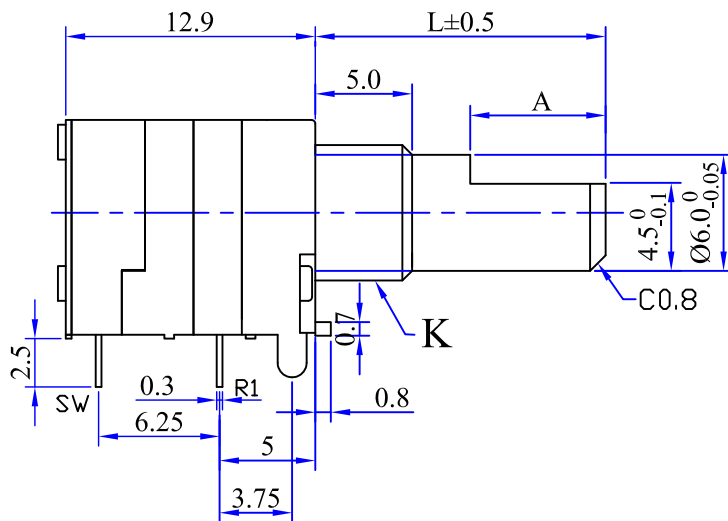
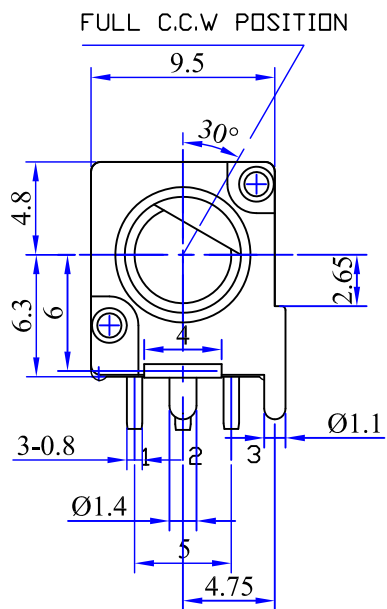
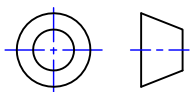

轴的类型:

FB Shaft Style

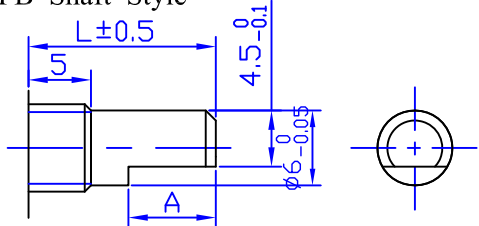

L	14.6	15	20	25	30
A	7	7	12	12	12

SB Shaft Style

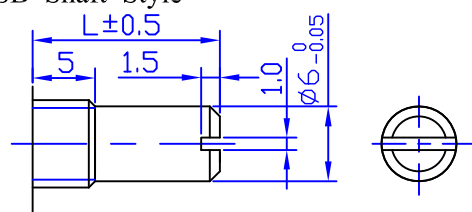

L	15	20	25	30
---	----	----	----	----

KQ Shaft Style

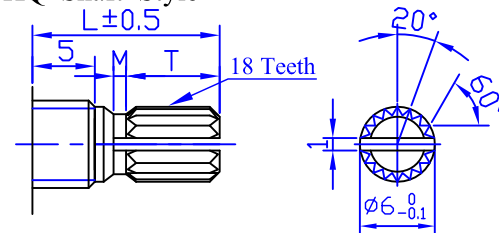

L	12	15	15	20	25
T	3.5	7.5	6	12	12
M	0.5	1	1	2	2

FD Shaft Style

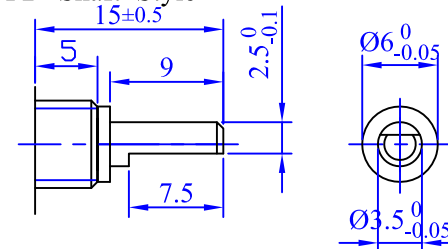

product code	K
R09760NS- 0029	Ø7
R09761NS- 0029	M7X0.75

未注尺寸公差	比例	2.5:1	版本	1.1	设计	审核	批准
L≤1.0吋 ±0.1	品名	R09761NS/R09760NS外形图					
1.0<L≤10吋 ±0.3		图号	R09761NS- 0029				
10<L≤30吋 ±0.5			R09760NS- 0029				
30<L≤100吋 ±1.0							

东莞市长泰尔电子有限公司

# 东莞市长泰尔电子有限公司

## DONG GUAN CHANG TAIER ELECTRONIC CO., LTD

### 阻抗变化特性 Resistance tapers

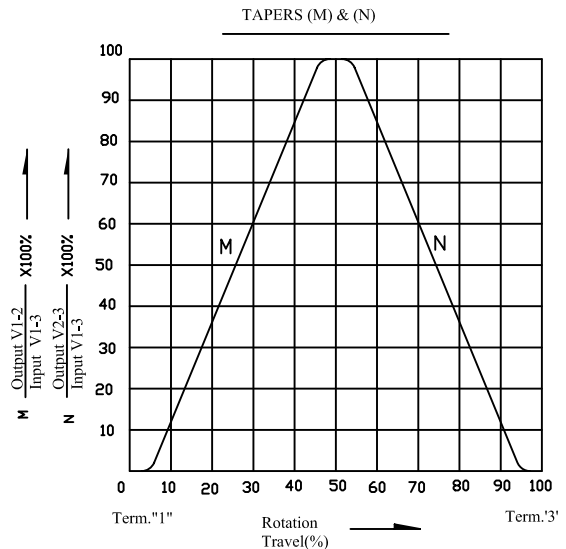
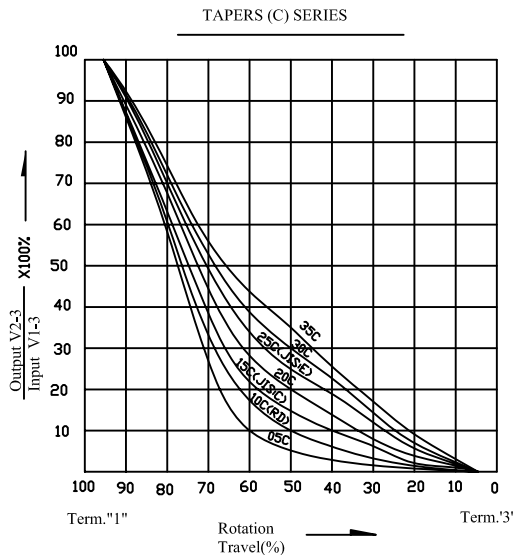
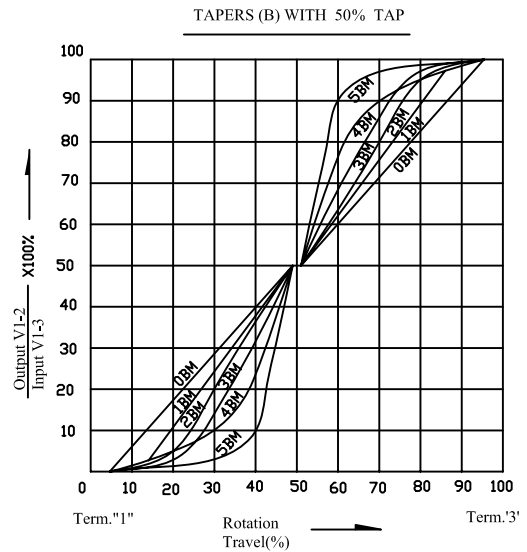
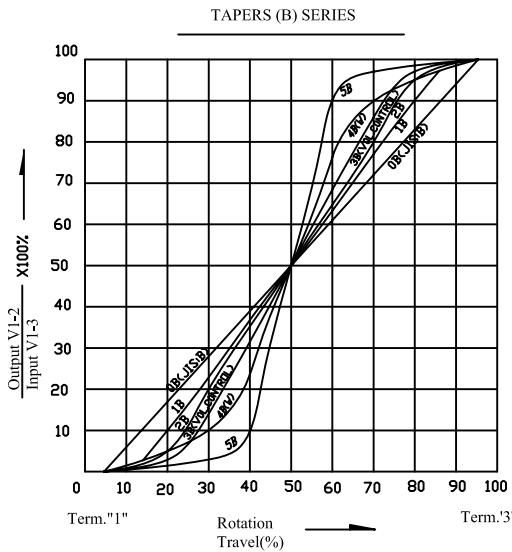
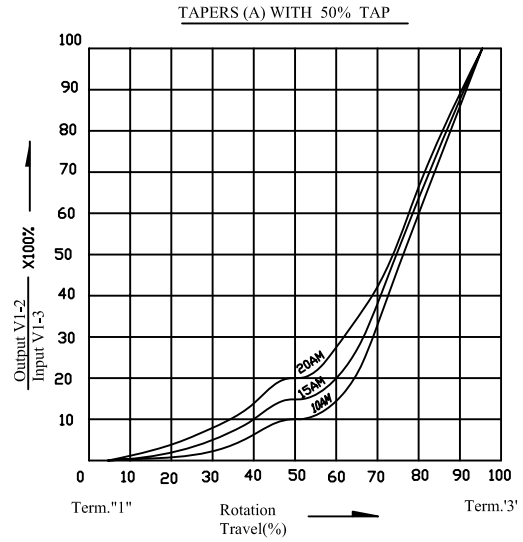
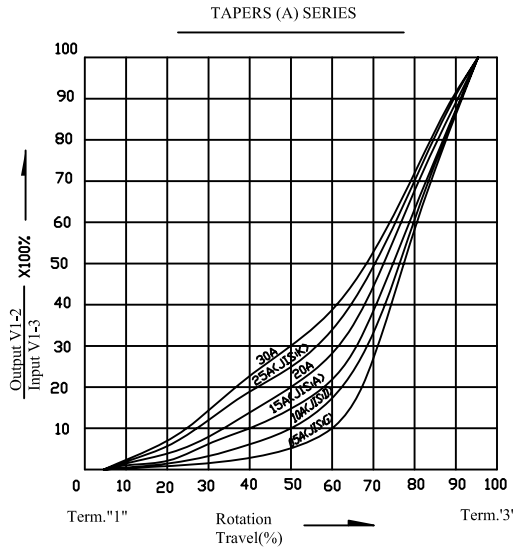

## X-ON Electronics

Largest Supplier of Electrical and Electronic Components

*Click to view similar products for [Potentiometers](#) category:*

*Click to view products by [CTR](#) manufacturer:*

Other Similar products are found below :

[580SX4Q25F102SP](#) [580SX4Q25F103ZP](#) [58C2-2](#) [590SX1N32F103SS](#) [591SXJ48S252SC](#) [591SXP56S252SC](#) [591SXP56S503SC](#) [D31409](#)  
[70B1G048K502X-A](#) [70B1M032S502W](#) [70B1N056S202W](#) [70B8N056F502W](#) [70J8N048S104U](#) [70L1N040P103W](#) [70L1N048P103X](#)  
[70L1N048S103W](#) [GA2G056S101UA](#) [GA2G056S251UA](#) [GA2G056S501UA](#) [GA2L040S102UC](#) [GA2L040S103UC](#) [GA2L040S501UC](#)  
[GS1G044P103UA](#) [GS1T032S103UA](#) [A43-1500](#) [A43-20K](#) [A47-200K](#) [A4720K](#) [RK14K1220-F25-C0-A103](#) [RK14K1220F25C0C104](#)  
[RK14K1220-F25-C1-B103](#) [14910FBGLFY00103KA](#) [C0342008 5K](#) [J97589](#) [RV170F-10-15R1-B500K-0021](#) [917523A](#) [A43-40](#) [A43-750](#)  
[A43S-5](#) [A47-15K](#) [A47-1K](#) [A4750K](#) [SPPG056P103U](#) [SWE-10](#) [GA2G040F103BA](#) [GA2G056S503UA](#) [GA2G056S504UA](#) [GA2L040S502UC](#)  
[GA2L040S503UC](#) [POT-3217-02 \(MW22S-3217-500\)](#)