

Industrial Rotary Switch

Features

- Hill and valley detent
- Balanced double bump detent spring
- 30° or 60° indexing
- Spring return styles available
- Adjustable stop available
- Solder lug and printed circuit terminals available
- Molded stator prevents solder from flowing into the circuit
- Custom switching patterns available
- Index or wafers are available separately
- RoHS compliant

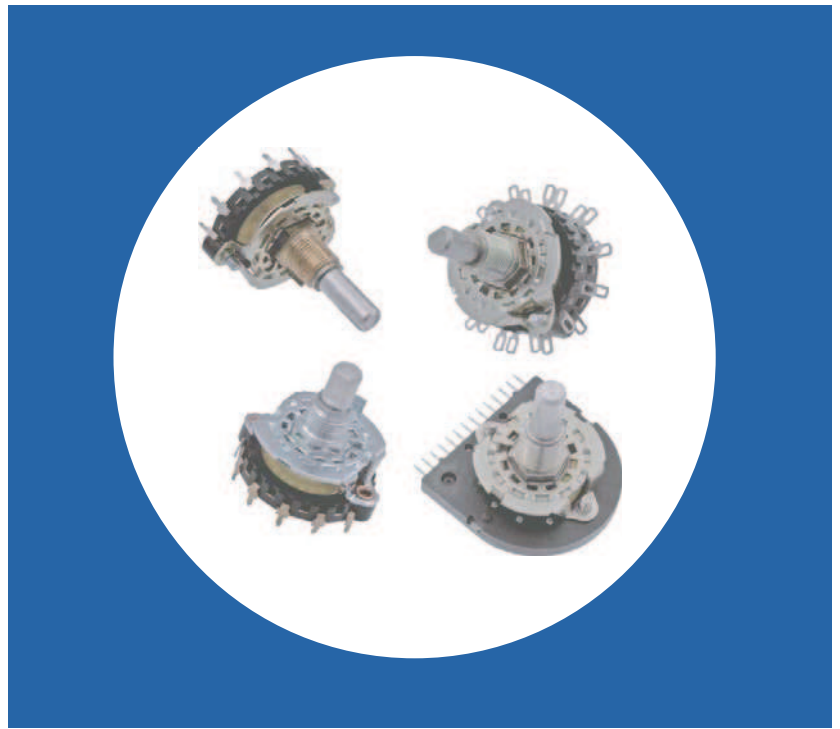

Electrical and Mechanical Specifications

Indexing

Double bump spring hill and valley detent with standard 30° indexing for 2 through 12 positions or with special 60° indexing from 2 to 6 positions.
Special 90° indexing consult CTS

Voltage and Current Rating

UL Rating: 3/4 amp at 125 VAC (shorting type only)
Special Rating: 1/4 amp at 28 VDC (shorting or non shorting)
1 amp at 28 VDC (shorting type only)

Contact Resistance

.015 ohm max. when measured from adjacent terminals

Stop Strength

15 in-lb (17.3 Kgf-cm)

Torque

Up to 48 in-oz. (3.4 Kgf-cm)

Detent Rotational Life

25,000 cycles

Materials

Shaft: Aluminum or unplated brass at CTS option
Bushing: Brass
Detent Spring: Spring brass or nickel silver depending on torque requirements
Front Plate: Zinc plated or nickel plated steel
Rotor Contacts, Stator Contacts and Terminals: Silver plated brass standard
Stator Insulator: Glass reinforced thermoset material

Bushing Lengths

Standard: 3/8"-32 UNEF-2A Thread, 1/4" (6.35mm) or 3/8" (9.53mm) long.
Special Lengths: Available as required

Locating Lugs

Standard: Left side .531" (13.5mm) radius
Special: Right side .531" (13.5mm) radius or no lug

Shaft Trim

Standard: Plain round, Flat, Slot, Knurl, or mixed (Flat with Slot)
Special: Available as request

Frames

Machine screw, bolt & nut, or rivet construction

Panel Seal

Available with bushing and shaft seal

Physical Dimensions

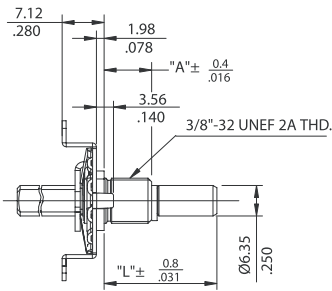

Detent Only

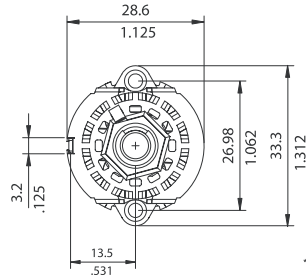

* NOTE:
10.62/.426 DIMENSION BASED UPON USE OF ONE 6.35/.250
NO SPACERS OR SPACERS OF NUMEROUS LENGTHS
ARE AVAILABLE TO PROVIDE PIN SPACINGS AS REQD.

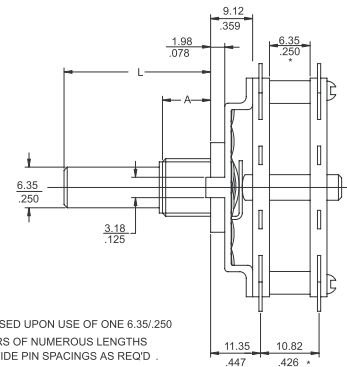

Typical Assembled Switch

DIMENSION: $\frac{\text{mm}}{\text{inch}}$

Available Terminal Styles

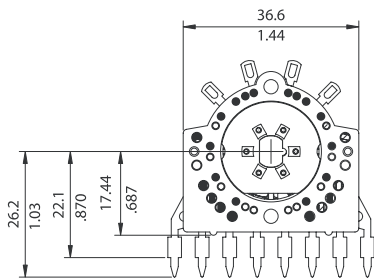

Y-Style

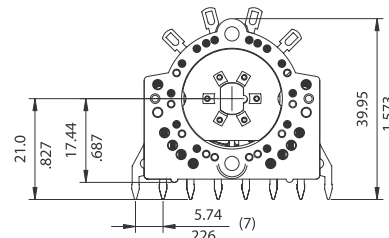

X-Style

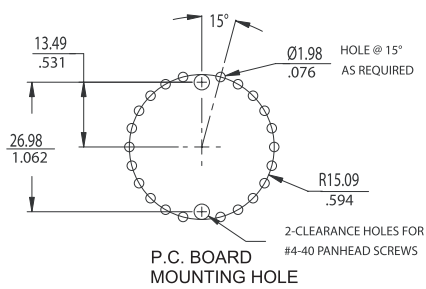

U-Style

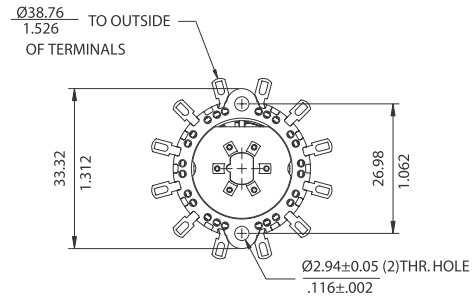

T-Style

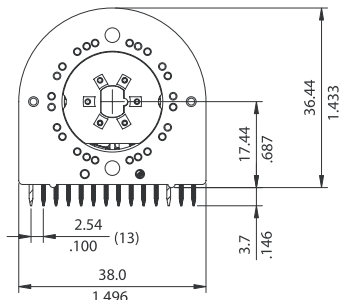
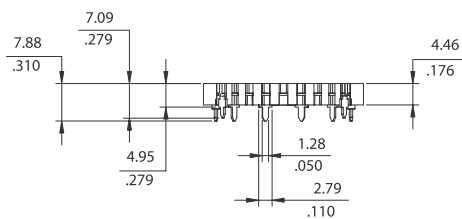

P-Style

DIMENSION: $\frac{\text{mm}}{\text{inch}}$

Ordering Information

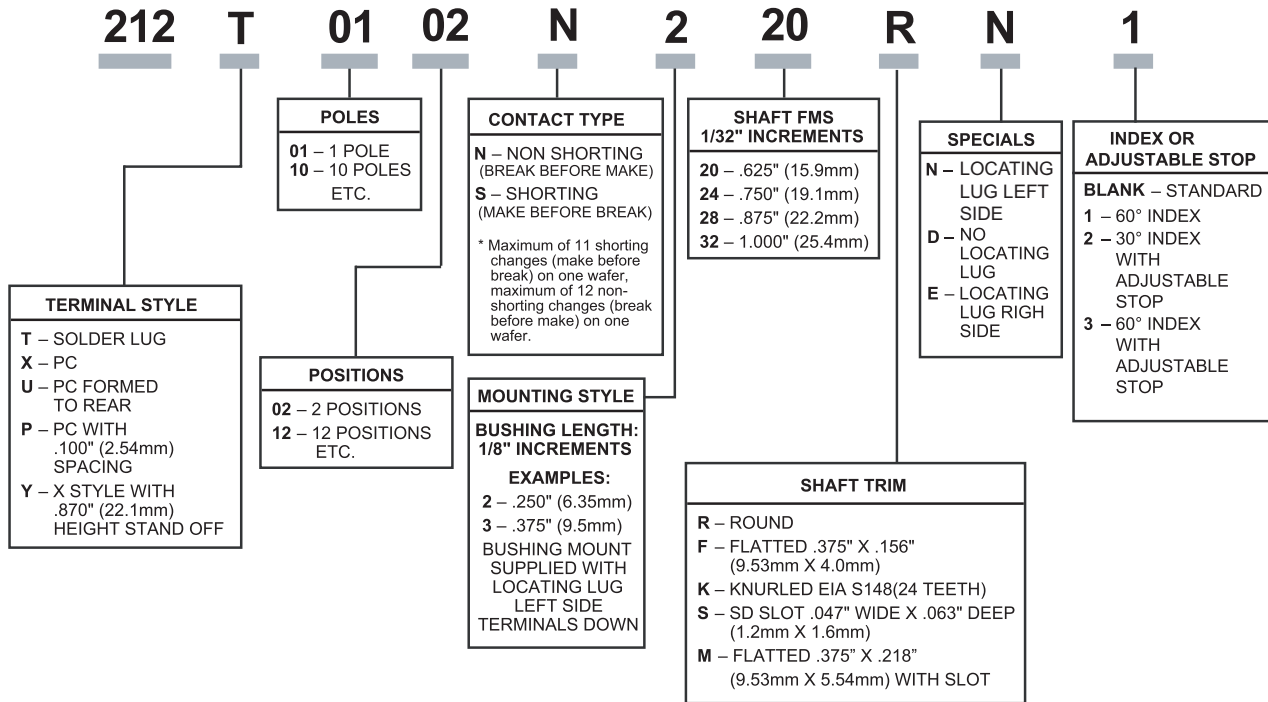

Note:

Consult CTS for other common standard features not listed.

X-ON Electronics

Largest Supplier of Electrical and Electronic Components

Click to view similar products for [Rotary Switches](#) category:

Click to view products by [CTS](#) manufacturer:

Other Similar products are found below :

[57HS22-02-2-06N](#) [57M22-02B16N](#) [57M22-09A16N](#) [58J1007](#) [58J8A45-01B05N](#) [59M18-02A20N](#) [M3786/39-3BA](#) [M3786/39-LMC](#)
[M3786/4-0007](#) [M3786/4-0073](#) [M3786/4-0182](#) [M3786/4-0640](#) [M3786/4-0873](#) [M3786/4-0881](#) [M3786/4-3187](#) [M3786/4-3267](#) [M3786/4-5272](#)
[M3786/4-5568](#) [M3786/4-5876](#) [M3786/4-6029](#) [71ESF30-05204N](#) [MC06L1NCGF](#) [FA201BKGN](#) [84986-26](#) [9003K2C003GA](#) [PLR3251](#)
[PLR3262](#) [PLR3279](#) [PS3](#) [A019305](#) [A019306](#) [A019501](#) [A029301](#) [A165W-T2AR](#) [R2AA2133NNNN](#) [R2AA4455NNNN](#) [R2BB4455NNNN](#)
[ACSNO-6123-FB-C6002](#) [RMS1224](#) [DR75-AMSF-10R-B](#) [14-520.0360](#) [BCK1006](#) [1703.3201](#) [HW1MS-0202-101](#) [C6P0206N-A](#) [24002-03S](#)
[A019109](#) [A029101](#) [A165W-T3MR](#) [A22NS-3BM-NRA-G120-NN](#)