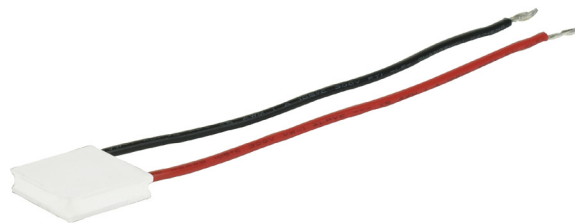

SERIES: CP39H | **DESCRIPTION:** PELTIER MODULE**FEATURES**

- arcTEC™ structure on select models
- enhanced reliability for high thermal cycling
- superior thermal performance
- silicon sealed
- wide ΔT max
- low profile
- precise temperature control
- solid state construction

**MODEL**

MODEL	input voltage ¹ max (Vdc)	input current ² max (A)	internal resistance ³ typ ($\Omega \pm 10\%$)	output Qmax ⁴		output ΔT max ⁵	
				T _h =27°C (W)	T _h =50°C (W)	T _h =27°C (°C)	T _h =50°C (°C)
CP39136H	3.8	3.9	0.85	8.6	9.5	70	77
CP39236H	8.8	3.9	1.95	18.7	20.9	70	77
CP39234030H	14.9	3.9	3.38	31.0	35.9	68	75
CP39301536H	7.6	3.9	1.73	16.5	18.1	70	77
CP393365H ⁶	15.7	3.9	3.50	35.2	39.0	70	77
CP394044365 ⁶	32.5	3.9	6.95 \pm 5%	71.8	80.0	70	77

- Notes:
1. Maximum voltage at ΔT max and T_h=27°C
 2. Maximum current to achieve ΔT max
 3. Measured by AC 4-terminal method at 25°C
 4. Maximum heat absorbed at cold side occurs at I_{max}, V_{max}, and $\Delta T=0^\circ\text{C}$
 5. Maximum temperature difference occurs at I_{max}, V_{max}, and Q=0W (ΔT max measured in a vacuum at 1.3 Pa)
 6. Designed with arcTEC™ structure.

SPECIFICATIONS

parameter	conditions/description	min	typ	max	units
solder melting temperature	connection between thermoelectric pairs	235			°C
assembly compression				1	MPa
RoHS	yes				

MECHANICAL DRAWING

units: mm

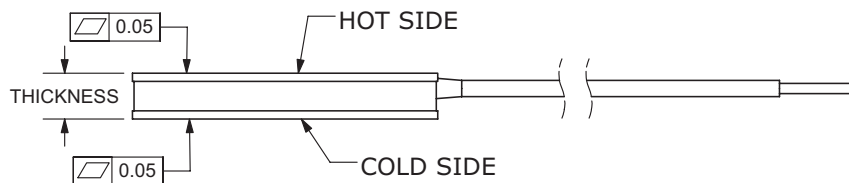

	MATERIAL	PLATING
ceramic plate	96% Al_2O_3	
wire leads	22 AWG	tin
sealer	silicon rubber 703 RTV (between cold and hot side plates)	
joint cover	silicon rubber 703 RTV	
marking	P/N & S/N printed on cold side surface	

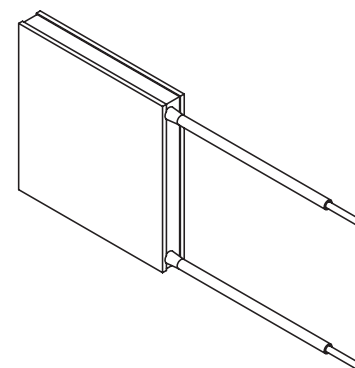
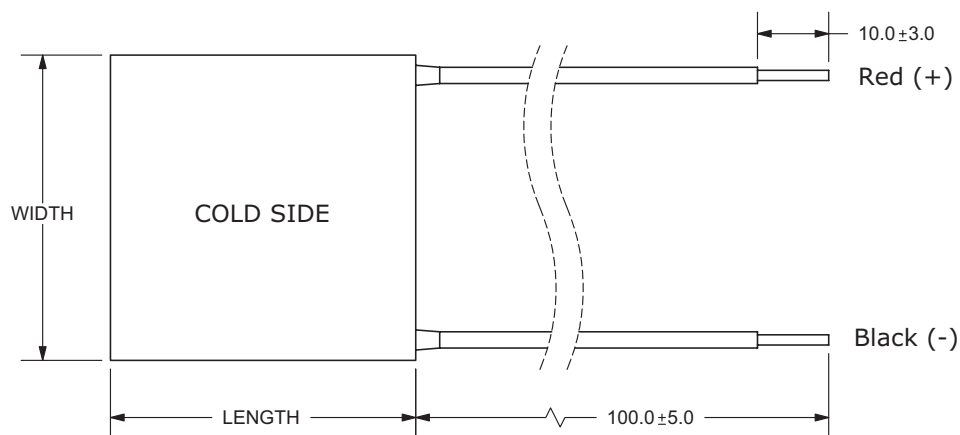

MODEL NO.	LENGTH (mm)	WIDTH (mm)	THICKNESS (mm)
CP39136H	15 ± 0.3	15 ± 0.3	3.6 ± 0.025
CP39236H	20 ± 0.3	20 ± 0.3	3.6 ± 0.025
CP39234030H	23 ± 0.3	40 ± 0.3	3.0 ± 0.05
CP39301536H	30 ± 0.3	15 ± 0.3	3.6 ± 0.025
CP393365H	30 ± 0.3	30 ± 0.3	3.65 ± 0.025
CP394044365	44 ± 0.3	40.5 ± 0.3	3.65 ± 0.1

CP39136H PERFORMANCE (Th=27°C)

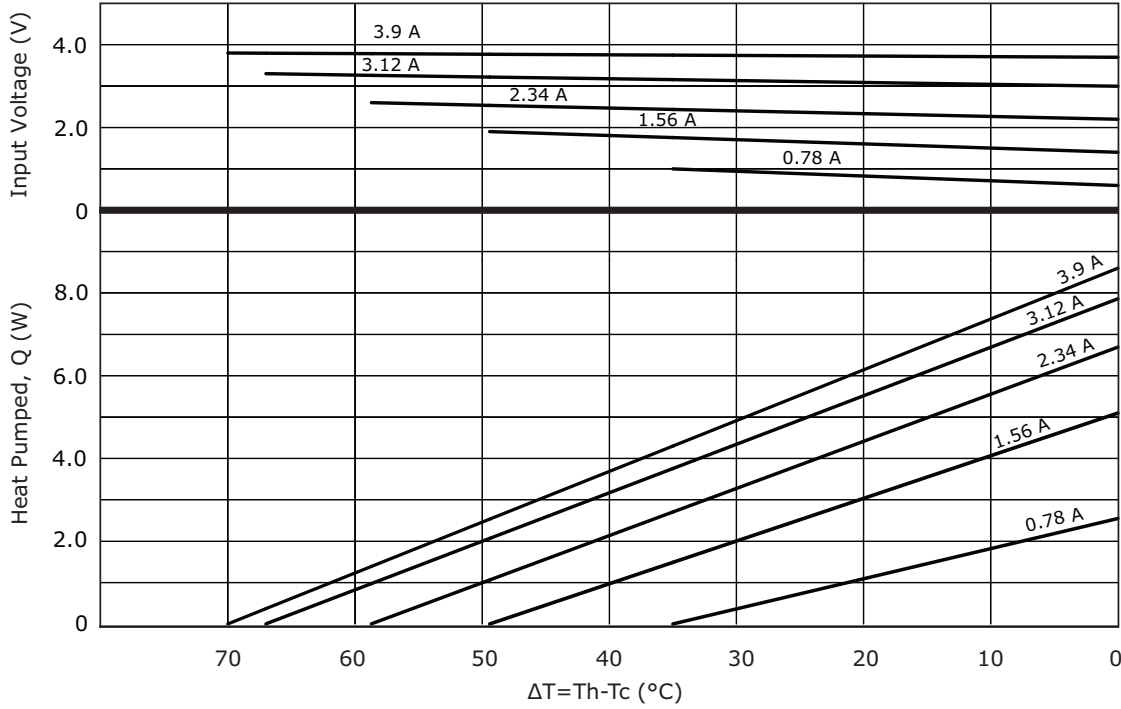

CP39136H PERFORMANCE (Th=50°C)

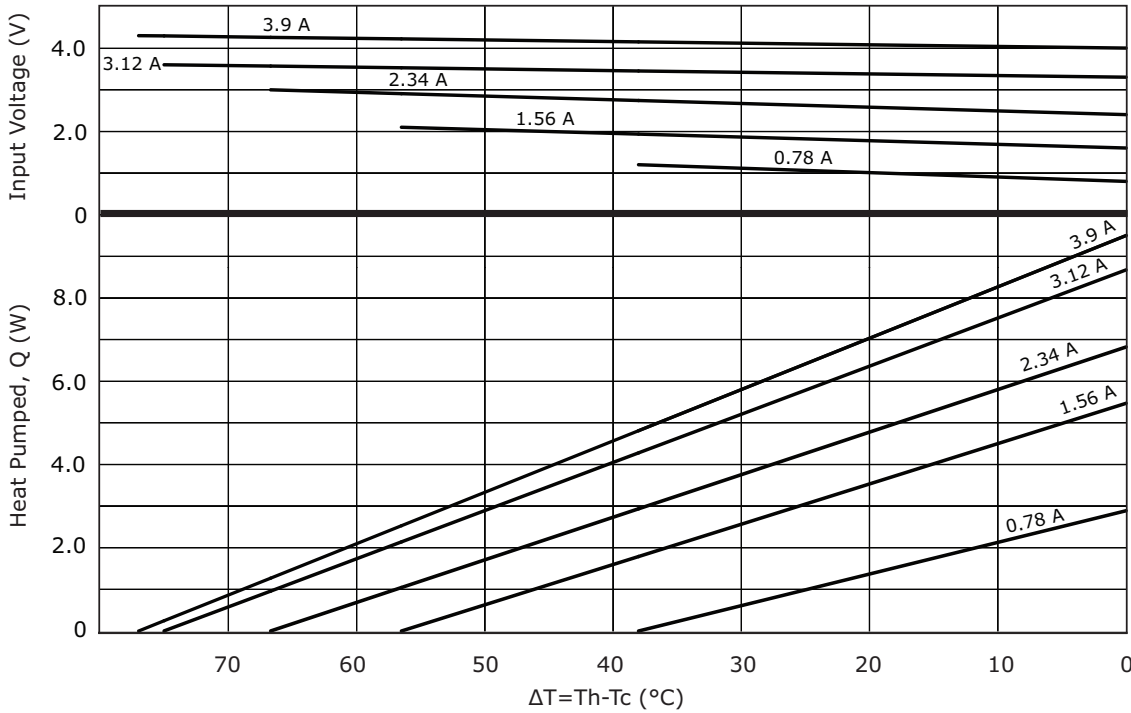

CP39236H PERFORMANCE (Th=27°C)

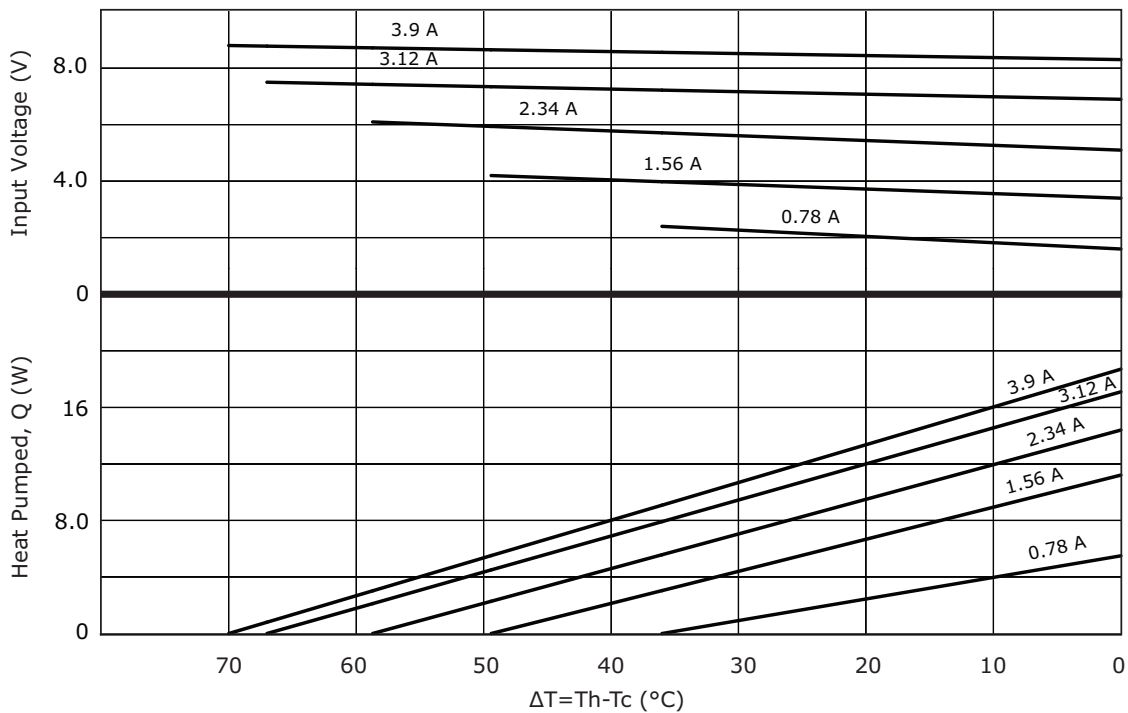

CP39236H PERFORMANCE (Th=50°C)

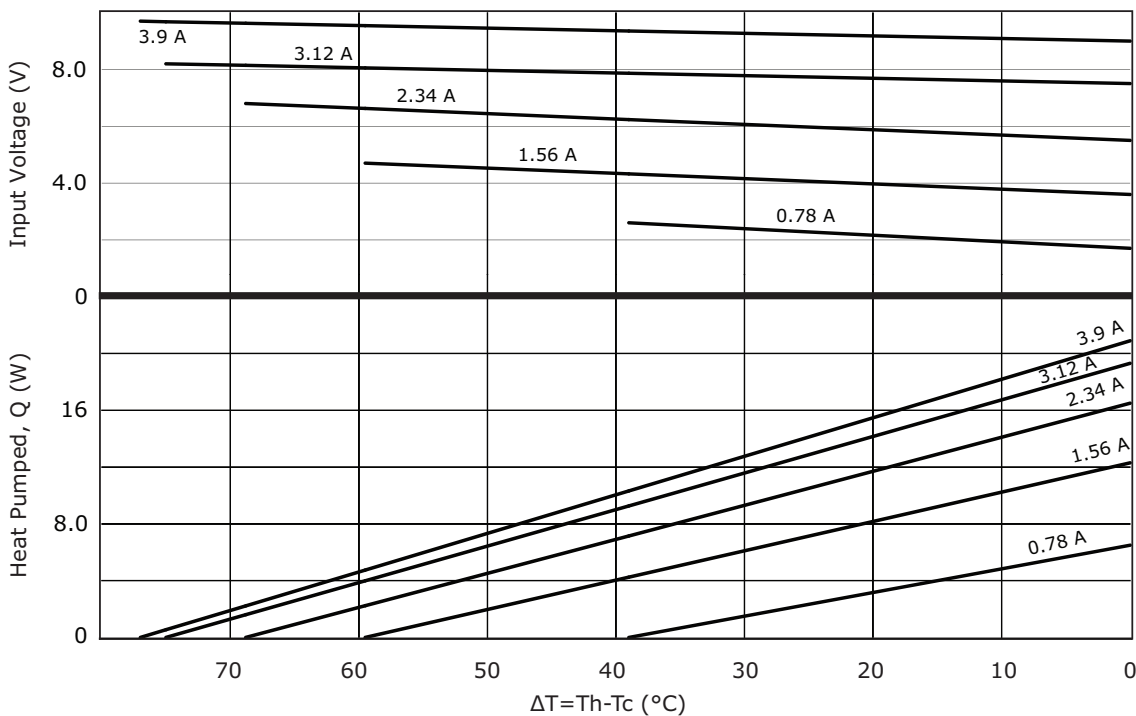

CP39234030H PERFORMANCE (Th=27°C)

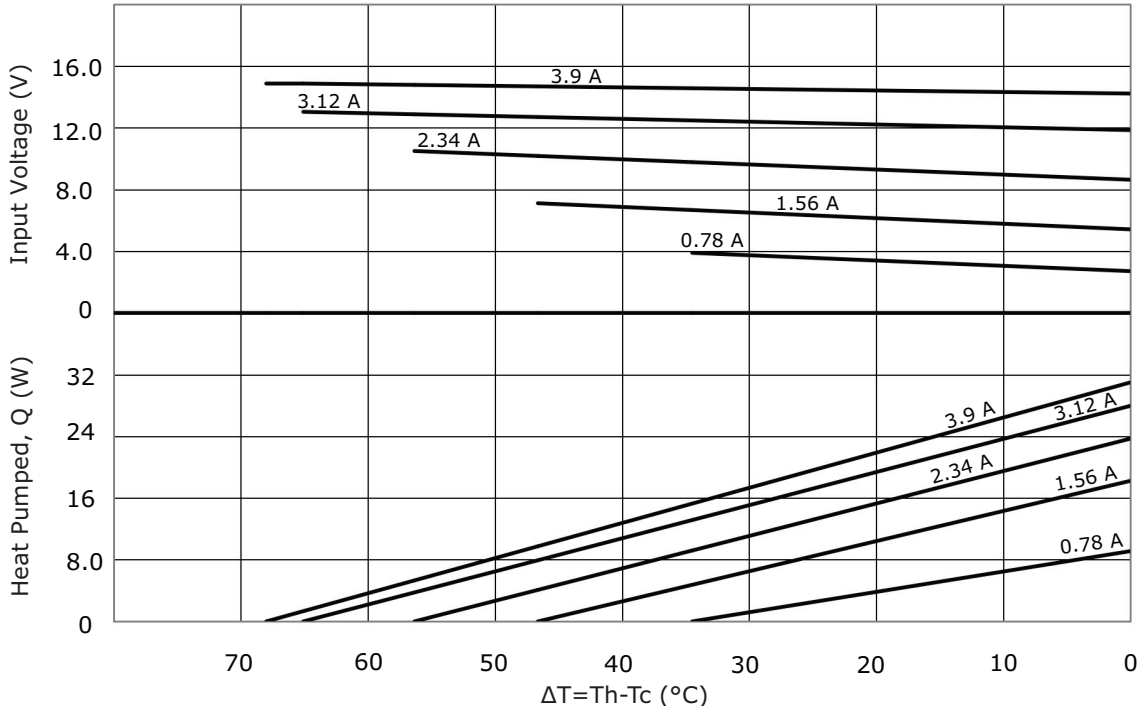

CP39234030H PERFORMANCE (Th=50°C)

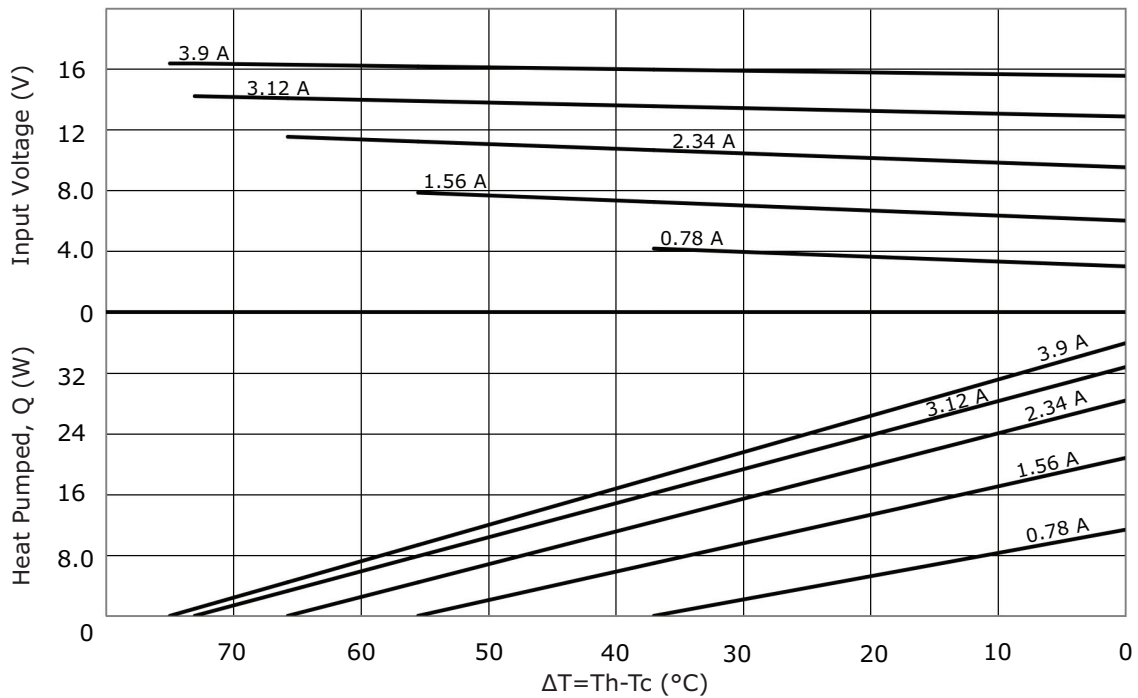

CP39301536H PERFORMANCE (Th=27°C)

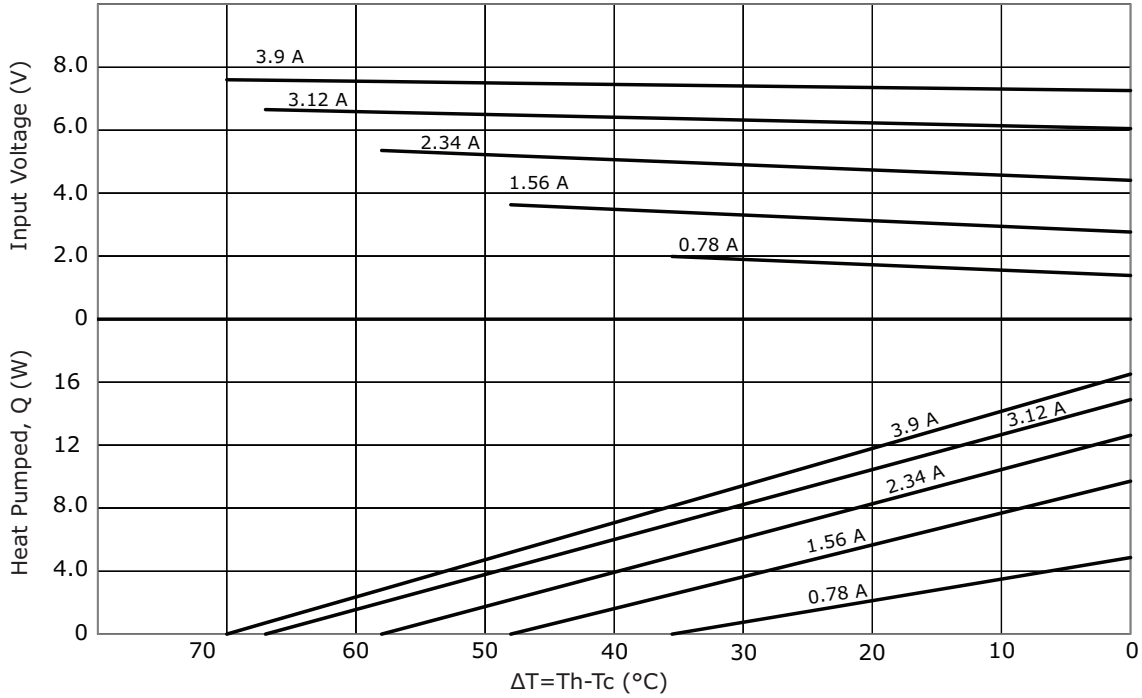

CP39301536H PERFORMANCE (Th=50°C)

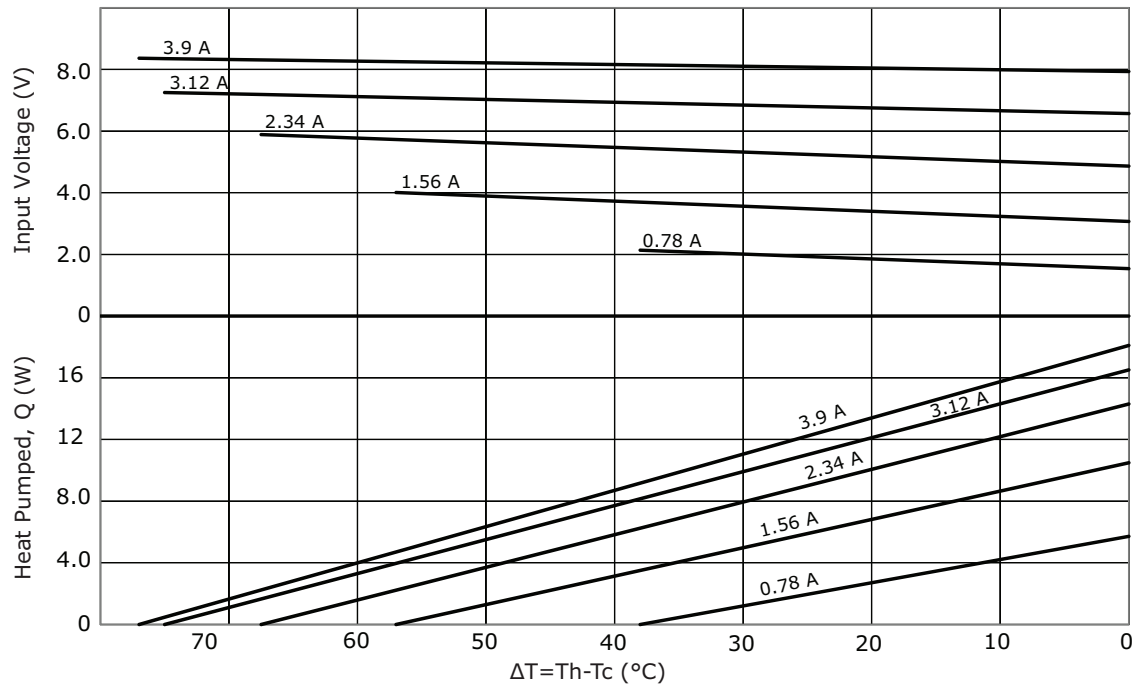

CP393365H PERFORMANCE (Th=27°C)

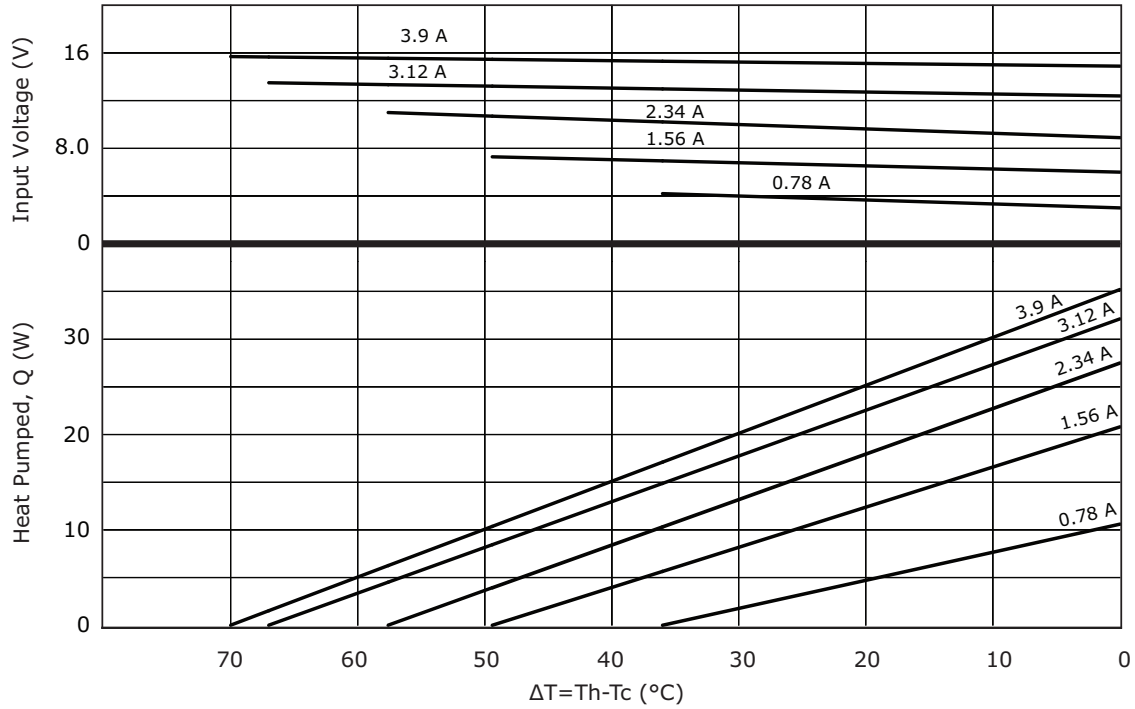

CP393365H PERFORMANCE (Th=50°C)

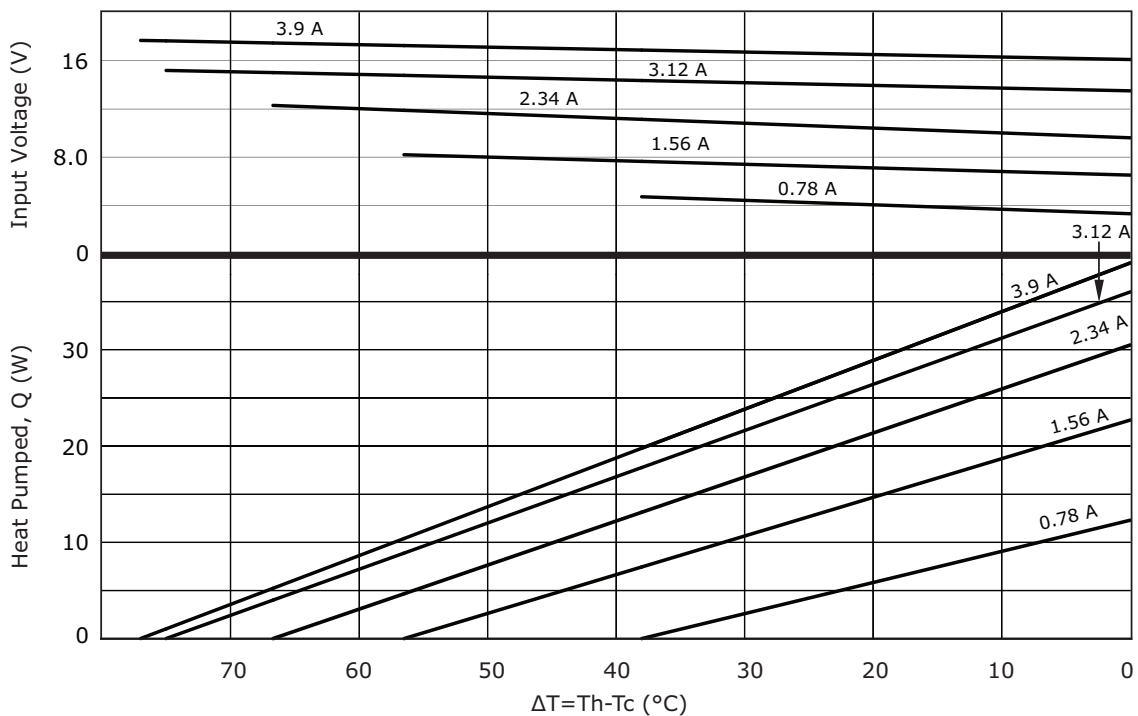

CP394044365 PERFORMANCE (Th=27°C)

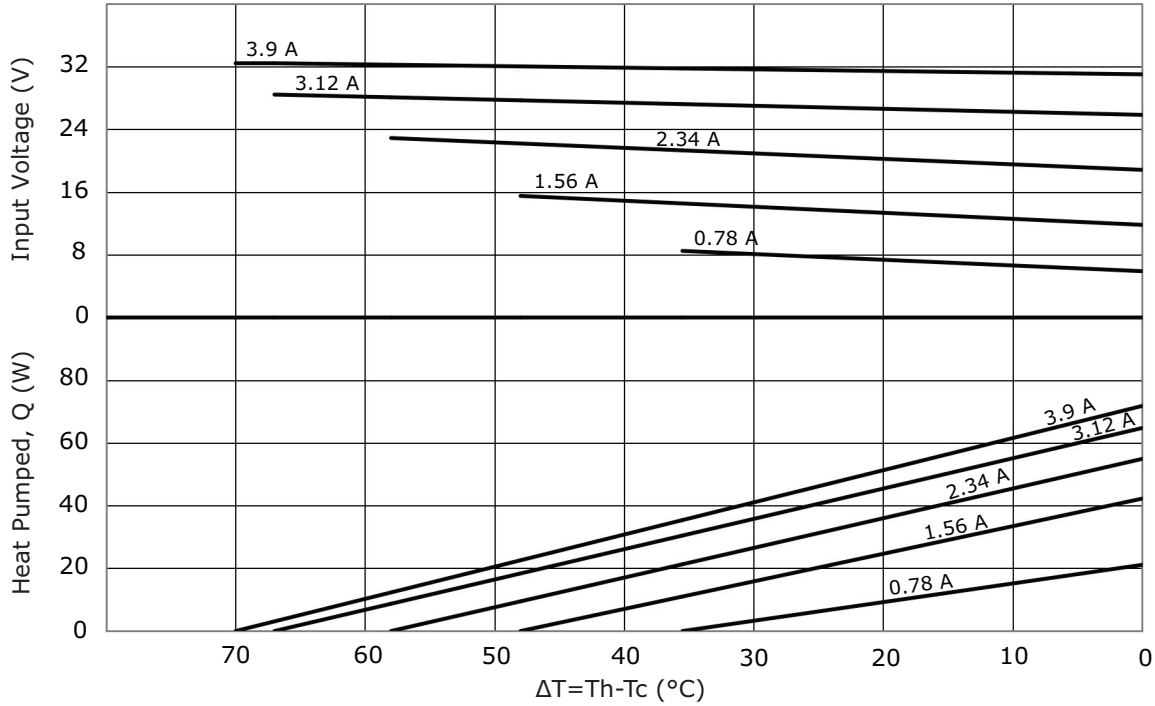

CP394044365 PERFORMANCE (Th=50°C)

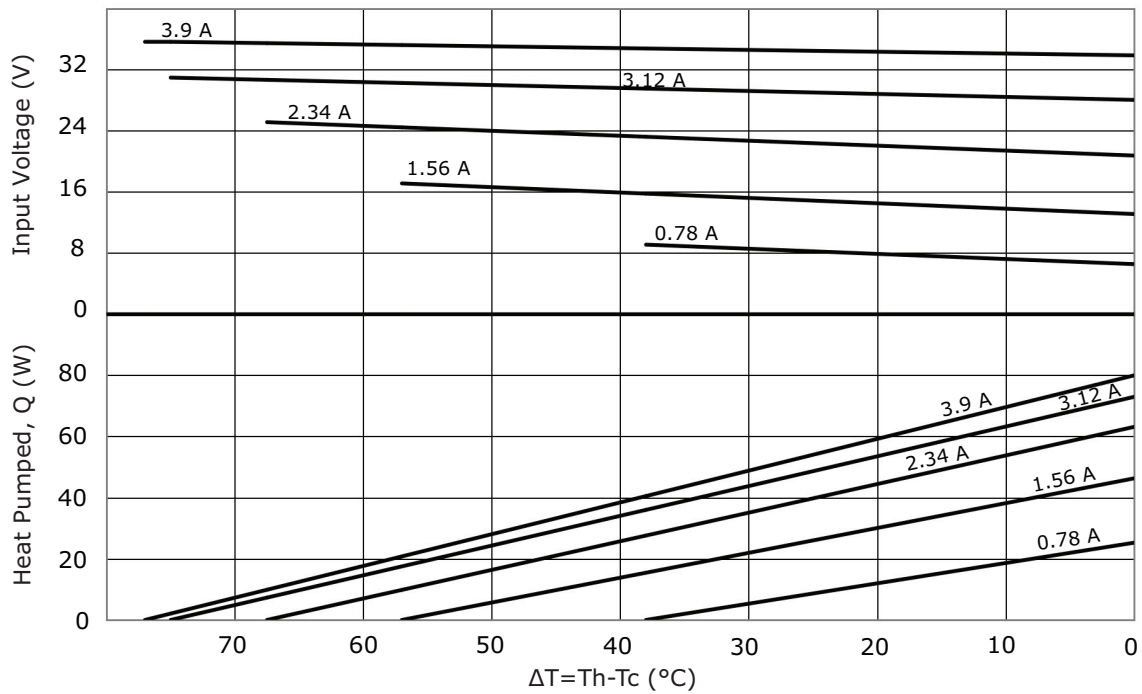

REVISION HISTORY

rev.	description	date
1.0	initial release	09/08/2016
1.01	updated datasheet	09/25/2017
1.02	added new model	05/21/2018
1.03	added model CP394044365, brand update	10/16/2019
1.04	added model CP39234030H	11/12/2020

The revision history provided is for informational purposes only and is believed to be accurate.

CUI DEVICES

CUI Devices offers a one (1) year limited warranty. Complete warranty information is listed on our website.

CUI Devices reserves the right to make changes to the product at any time without notice. Information provided by CUI Devices is believed to be accurate and reliable. However, no responsibility is assumed by CUI Devices for its use, nor for any infringements of patents or other rights of third parties which may result from its use.

CUI Devices products are not authorized or warranted for use as critical components in equipment that requires an extremely high level of reliability. A critical component is any component of a life support device or system whose failure to perform can be reasonably expected to cause the failure of the life support device or system, or to affect its safety or effectiveness.

X-ON Electronics

Largest Supplier of Electrical and Electronic Components

Click to view similar products for [Thermoelectric Peltier Modules](#) category:

Click to view products by [CUI Devices](#) manufacturer:

Other Similar products are found below :

[C3100-1980](#) [C3200-0504](#) [C3200-0505](#) [C3200-371](#) [C3400-0262](#) [430084-505](#) [C3400-215](#) [430866-501](#) [CP39136H](#) [CP35447](#) [CP85204035](#)
[CP60131H](#) [CPM-2F](#) [CP853345H](#) [CP85138](#) [CP35347](#) [430077-523](#) [CP081030-M](#) [CP12437](#) [CP30138H](#) [CP30338](#) [CP303385H](#) [CP35247](#)
[CP39236H](#) [CP393365H](#) [CP40236](#) [CP40247](#) [CP40347](#) [CP50441](#) [CP60231H](#) [CP60233](#) [CP60239H](#) [CP60240](#) [CP60301540](#) [CP60333](#)
[CP603395H](#) [CP60340](#) [CP604395H](#) [CP60440](#) [CP70437](#) [CP854345H](#) [CP854705-2](#) [CP10205033](#) [CP10304033](#) [CP1054033H](#) [CP115035335](#)
[CP144745325](#) [CP200543636](#) [CP2020405H](#) [CP203475H](#)