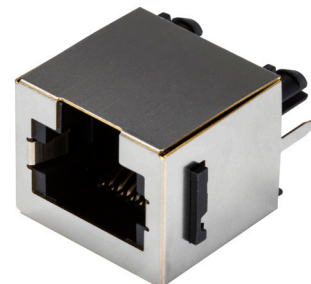

**MODEL:** CRJ024-1-TH | **DESCRIPTION:** MODULAR JACK**FEATURES**

- 6P6C (RJ12)
- mounting flange
- shielded

**SPECIFICATIONS**

| parameter                  | conditions/description   | min | typ   | max  | units  |
|----------------------------|--|-----|-------|------|--------|
| rated voltage              |  |     |       | 150  | Vac    |
| rated current              |  |     |       | 1.5  | A      |
| withstanding voltage       | for 1 minute   |     | 1,500 |      | Vac    |
| contact resistance         |  |     |       | 40   | mΩ     |
| insulation resistance      |  | 500 |       |      | MΩ     |
| insertion/withdrawal force |  |     |       | 6.12 | kgf    |
| operating temperature      |  | 0   |       | 70   | °C     |
| storage temperature        |  | -40 |       | 80   | °C     |
| life                       |  |     | 1,000 |      | cycles |
| flammability rating        | UL94V-0  |     |       |      |        |
| RoHS                       | yes  |     |       |      |        |
| packaging                  | carton size: 400 x 303 x 258 mm<br>tray QTY: 90 pcs per tray<br>carton QTY: 2,700 pcs per carton |     |       |      |        |

**SOLDERABILITY**

| parameter      | conditions/description | min | typ | max | units |
|----------------|------------------------|-----|-----|-----|-------|
| wave soldering | for maximum 5 seconds  |     |     | 240 | °C    |

## MECHANICAL DRAWING

units: mm  
 tolerance:  
 X ±0.5 mm  
 X.X ±0.38 mm  
 X.XX ±0.25 mm  
 X.XXX ±0.10 mm  
 PCB: ±0.05 mm  
 PCB thickness: 1.6 mm  
 unless otherwise noted

| ITEM | DESCRIPTION       | MATERIAL        | PLATING/COLOR   |
|------|-------------------|-----------------|---|
| 1    | insulator         | PBT (UL94V-0)   | black   |
| 2    | contact terminals | phosphor bronze | contact area: 6 μ" gold over nickel<br>solder area: matte tin over nickel |
| 3    | shield            | brass           | nickel alloy  |

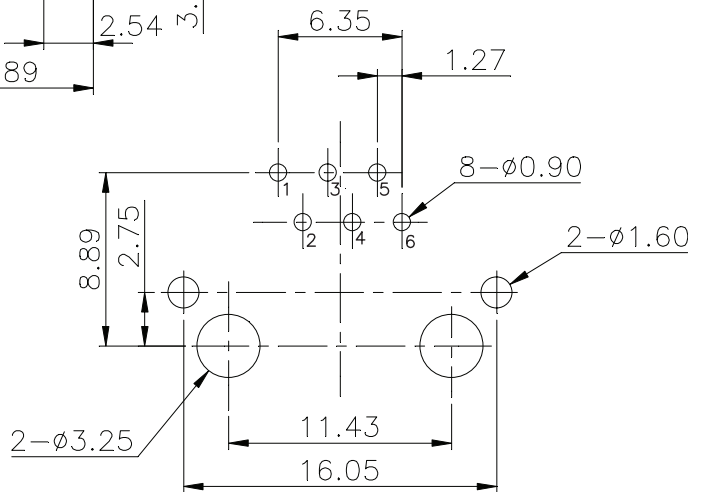
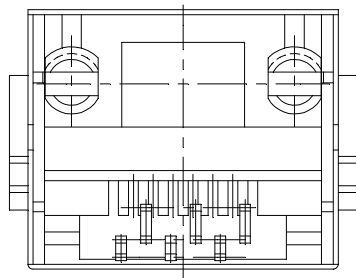
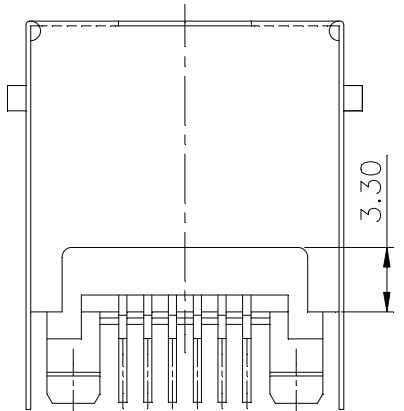
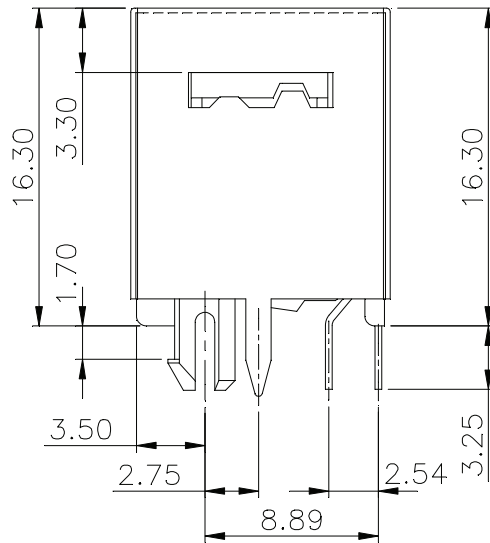
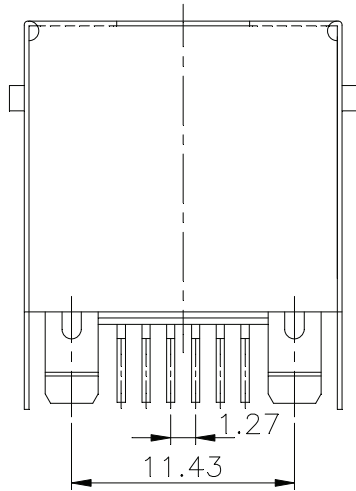
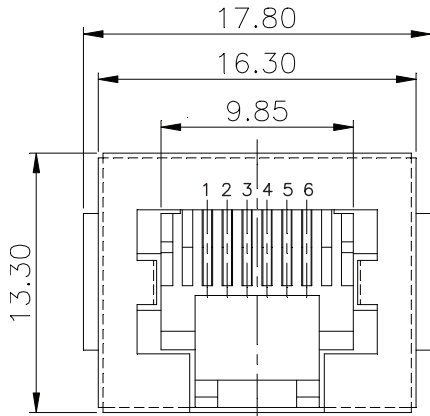

Recommended PCB Layout  
Top View

## REVISION HISTORY

---

| rev. | description     | date       |
|------|-----------------|------------|
| 1.0  | initial release | 03/29/2021 |

The revision history provided is for informational purposes only and is believed to be accurate.

---

# CUI DEVICES

CUI Devices offers a one (1) year limited warranty. Complete warranty information is listed on our website.

CUI Devices reserves the right to make changes to the product at any time without notice. Information provided by CUI Devices is believed to be accurate and reliable. However, no responsibility is assumed by CUI Devices for its use, nor for any infringements of patents or other rights of third parties which may result from its use.

CUI Devices products are not authorized or warranted for use as critical components in equipment that requires an extremely high level of reliability. A critical component is any component of a life support device or system whose failure to perform can be reasonably expected to cause the failure of the life support device or system, or to affect its safety or effectiveness.

## X-ON Electronics

Largest Supplier of Electrical and Electronic Components

*Click to view similar products for [Modular Connectors](#) / [Ethernet Connectors](#) category:*

*Click to view products by [CUI Devices](#) manufacturer:*

Other Similar products are found below :

[8949-H88/06BLKA/SN](#) [74441-0010/BKN](#) [PHP-6P6C-5](#) [GAX-3-66](#) [GAX-8-62](#) [GDCX-PN-66](#) [GLX-A-44](#) [GLX-N-1010M-BLK](#) [GMX-SMT4-N-88](#) [GSGX-N-2-88](#) [GSGX-N-4-88](#) [GSX-NS2-88-3.05](#) [GSX-NS-88-3.68](#) [PT-108A-8C-UL](#) [PTS-J531-8CS-50UL](#) [A-2014-0-4](#)  
[GWLX-S9-88-YG](#) [DC-1021-8-WH-6](#) [1300530003](#) [1324640-4](#) [RJ11FTVC2G](#) [RJ11FTVC2N](#) [RJFTVX2SA1G](#) [132764-001](#) [1413235](#)  
[MPS88RX-5000](#) [E5288-S000K3-L](#) [155302-001](#) [AX101050](#) [AX101063](#) [AX101065](#) [AX101072](#) [AX101307](#) [AX101315](#) [AX101318](#)  
[AX102271](#) [AX102288](#) [AX102651](#) [AX102660](#) [J0012D21NL](#) [J0026D01ENL](#) [PC4D0018P](#) [8949-B88/6](#) [2-6609208-5](#) [937-SP-3088-2PC-A192](#)  
[303066VFL](#) [303068V](#) [303088LFLSA](#) [303088SBL](#) [30-8603](#)