

**MODEL:** MJ1-2503A | **DESCRIPTION:** AUDIO JACK**FEATURES**

- through hole design
- low profile

**SPECIFICATIONS**

parameter	conditions/description	min	typ	max	units
rated input voltage			12		Vdc
rated input current				1	A
contact resistance <sup>1</sup>	between terminal and mating plug between terminal and shunt			50 30	mΩ mΩ
insulation resistance	at 500 Vdc	100			MΩ
voltage withstand	for 1 minute			500	Vac
insertion/withdrawal force		0.3		3	kg
operating temperature		-25		85	°C
life	at a rate of 24 cycles/minute		5,000		cycles
flammability rating	UL94V-0				
RoHS	yes				

Note: 1. When measured at a current of less than 100 mA/1 kHz  
2. All specifications measured at 10~35°C, humidity at 45~85%, under standard atmospheric pressure, unless otherwise noted.

**SOLDERABILITY**

parameter	conditions/description	min	typ	max	units
wave soldering	dipped in solder pot for 5 ±0.5 seconds	255	260	265	°C

## MECHANICAL DRAWING

units: mm  
 tolerance:  
 X.X ±0.2 mm  
 X.XX ±0.10 mm  
 X.XXX ±0.050 mm  
 PCB: ±0.05 mm

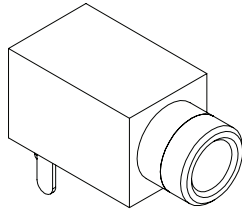

	MATERIAL	PLATING
terminal 1	copper alloy	silver
terminal 2	copper alloy	silver
terminal 3	copper alloy	silver
bushing	brass	nickel
plastic	PBT	

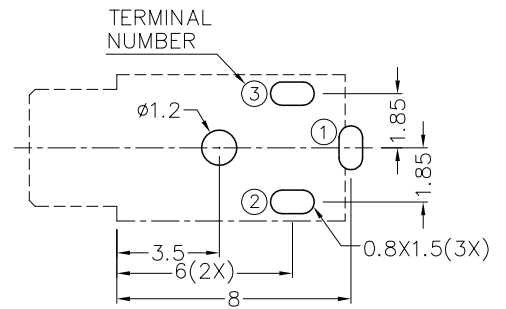
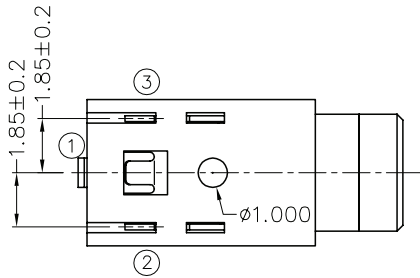
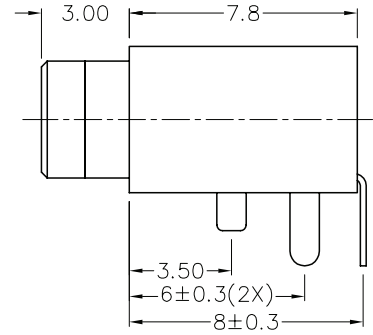
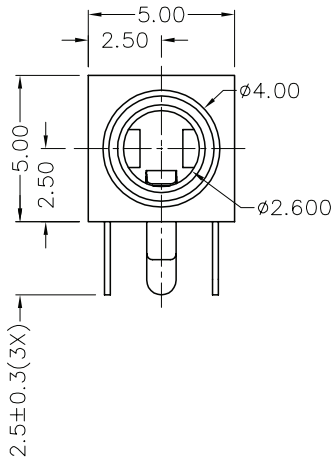
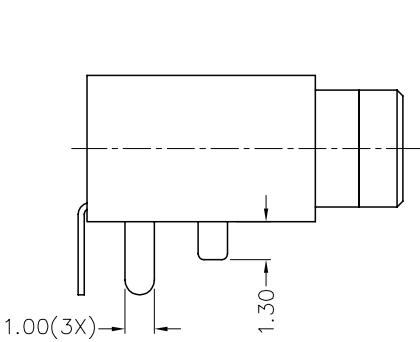

Recommended PCB Layout  
Top View

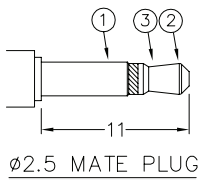

Schematic	
PIN	
1	sleeve
2	tip
3	tip

## REVISION HISTORY

---

rev.	description	date
1.0	initial release	01/18/2006
1.01	changed terminal plating to silver	02/13/2019
1.02	brand update	10/04/2019

The revision history provided is for informational purposes only and is believed to be accurate.

---

# CUI DEVICES

CUI Devices offers a one (1) year limited warranty. Complete warranty information is listed on our website.

CUI Devices reserves the right to make changes to the product at any time without notice. Information provided by CUI Devices is believed to be accurate and reliable. However, no responsibility is assumed by CUI Devices for its use, nor for any infringements of patents or other rights of third parties which may result from its use.

CUI Devices products are not authorized or warranted for use as critical components in equipment that requires an extremely high level of reliability. A critical component is any component of a life support device or system whose failure to perform can be reasonably expected to cause the failure of the life support device or system, or to affect its safety or effectiveness.

## X-ON Electronics

Largest Supplier of Electrical and Electronic Components

*Click to view similar products for [Phone Connectors](#) category:*

*Click to view products by [CUI Devices](#) manufacturer:*

Other Similar products are found below :

[M444B](#) [6J1041A](#) [R4F](#) [E12BPKG](#) [ECP4PKG](#) [163-157J-E](#) [MT333X](#) [171-0350-EX](#) [171-101A-EX](#) [171-3325-EX](#) [176S](#) [NC3MG-V](#)  
[NS112BX](#) [NYS228G](#) [P10834](#) [P2380](#) [P2381X](#) [P2411X](#) [P2412](#) [P2724](#) [JM2PB-AU BULK](#) [9144](#) [S2674](#) [280L](#) [163-158N-2-E](#) [171-3308-EX](#)  
[171-3500-E](#) [ST-3141-5N](#) [2501FT](#) [CMT335](#) [M10662](#) [330Q](#) [RJ5VI-S](#) [40116](#) [TM1R-AU](#) [TM2PBMJ-AU](#) [TM2PJ-AU](#) [TM2PJ-AU BULK](#)  
[4803.1351](#) [49201](#) [49205](#) [TS3PBJ-AU](#) [TS3PBMJ-AU](#) [TT32BX](#) [54B](#) [C55BX](#) [40112](#) [40205](#) [415](#) [XMT332B](#)