

**SERIES:** PCN2-S | **DESCRIPTION:** DC-DC CONVERTER**FEATURES**

- up to 2 W isolated output
- industry standard SIP package
- nominal input voltages: 5, 12, 24 Vdc
- single/dual unregulated output
- 1,000 Vdc isolation voltage
- low ripple and noise
- -40 to 100°C
- efficiency up to 86%

**MODEL**

MODEL	input voltage		output voltage	output current		output power	ripple & noise <sup>1</sup>	efficiency
	typ (Vdc)	range (Vdc)	(Vdc)	min (mA)	max (mA)	max (W)	max (mVp-p)	typ (%)
PCN2-S5-S5-S	5	4.5~5.5	5	0	400	2	100	82
PCN2-S5-S12-S	5	4.5~5.5	12	0	167	2	150	86
PCN2-S5-S15-S	5	4.5~5.5	15	0	134	2	150	85
PCN2-S5-D5-S	5	4.5~5.5	±5	0	±200	2	150	83
PCN2-S5-D12-S	5	4.5~5.5	±12	0	±83	2	150	86
PCN2-S5-D15-S	5	4.5~5.5	±15	0	±67	2	150	86
PCN2-S12-S5-S	12	10.8~13.2	5	0	400	2	100	82
PCN2-S12-S12-S	12	10.8~13.2	12	0	167	2	150	83
PCN2-S12-S15-S	12	10.8~13.2	15	0	134	2	150	84
PCN2-S12-D5-S	12	10.8~13.2	±5	0	±200	2	150	82
PCN2-S12-D12-S	12	10.8~13.2	±12	0	±83	2	150	82
PCN2-S12-D15-S	12	10.8~13.2	±15	0	±67	2	150	84
PCN2-S24-S5-S	24	21.6~26.4	5	0	400	2	100	79
PCN2-S24-S12-S	24	21.6~26.4	12	0	167	2	150	81
PCN2-S24-S15-S	24	21.6~26.4	15	0	134	2	150	82
PCN2-S24-D5-S	24	21.6~26.4	±5	0	±200	2	150	79
PCN2-S24-D12-S	24	21.6~26.4	±12	0	±83	2	150	81
PCN2-S24-D15-S	24	21.6~26.4	±15	0	±67	2	150	82

Notes: 1. At full load, nominal input, 20 MHz bandwidth oscilloscope, with a 0.33  $\mu$ F ceramic capacitor on the output.  
 2. Required to add a 2.2  $\mu$ F (5 & 12 Vdc input models) or 10  $\mu$ F (24 Vdc input models) ceramic capacitor to the input to reduce input voltage stress.  
 3. All specifications are measured at  $T_a=25^\circ\text{C}$ , nominal input voltage, and rated output load unless otherwise specified.

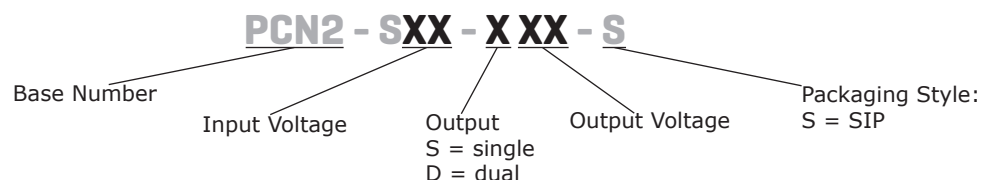
**PART NUMBER KEY**

## INPUT

parameter	conditions/description	min	typ	max	units
operating input voltage	5 Vdc input models	4.5	5	5.5	Vdc
	12 Vdc input models	10.8	12	13.2	Vdc
	24 Vdc input models	21.6	24	26.4	Vdc
surge voltage	for maximum of 100 ms				
	5 Vdc input models			9	Vdc
	12 Vdc input models			18	Vdc
	24 Vdc input models			30	Vdc
current	5 Vdc input models		500		mA
	12 Vdc input models		210		mA
	24 Vdc input models		110		mA
filter	capacitive				
input reverse polarity protection	no				
input fuse	1 A time delay fuse for 5 Vdc input models (recommended)				
	500 mA time delay fuse for 12 Vdc input models (recommended)				
	250 mA time delay fuse for 24 Vdc input models (recommended)				

Notes: 1. Required to add a 2.2  $\mu$ F (5 & 12 Vdc input models) or 10  $\mu$ F (24 Vdc input models) ceramic capacitor to the input to reduce input voltage stress.

## OUTPUT

parameter	conditions/description	min	typ	max	units
maximum capacitive load	at full load			470	$\mu$ F
voltage accuracy				$\pm 3.0$	%
line regulation	1.0% change in input voltage			$\pm 1.2$	%
load regulation	from full load to 20% load			$\pm 10$	%
switching frequency	at nominal $V_{in}$ , full load		80		kHz
temperature coefficient				$\pm 0.05$	%/ $^{\circ}$ C

## PROTECTIONS

parameter	conditions/description	min	typ	max	units
short circuit protection	momentary			1	s

## SAFETY AND COMPLIANCE

parameter	conditions/description	min	typ	max	units
isolation voltage	input to output for 1 minute	1,000			Vdc
isolation resistance	input to output	1,000			M $\Omega$
isolation capacitance	input to output		15		pF
conducted emissions	EN 55022 Class A & Class B (external circuit required, see Figure 4)				
MTBF	as per MIL-HDBK-217F, full load, GB, 25 $^{\circ}$ C		3,300,000		hours
RoHS	2011/65/EU				

## ENVIRONMENTAL

parameter	conditions/description	min	typ	max	units
operating temperature	see derating curve	-40		100	$^{\circ}$ C
storage temperature		-55		125	$^{\circ}$ C
operating humidity	non-condensing			95	%

## SOLDERABILITY

parameter	conditions/description	min	typ	max	units
wave soldering	see wave soldering profile			260	°C

- Notes:
1. Soldering materials: Sn/Cu/Ni
  2. Ramp up rate during preheat: 1.4°C/s (from 50°C to 100°C)
  3. Soaking temperature: 0.5°C/s (from 100°C to 130°C), 60±20 seconds
  4. Peak temperature: 260°C, above 250°C for 3~6 seconds
  5. Ramp down rate during cooling: -10°C/s (from 260°C to 150°C)

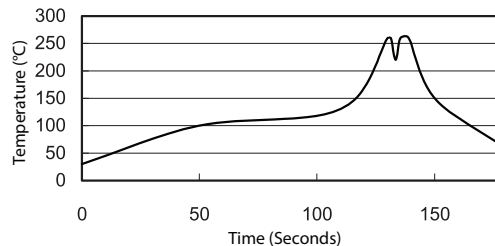

## MECHANICAL

parameter	conditions/description	min	typ	max	units
dimensions	0.77 x 0.28 x 0.40 [19.6 x 7.2 x 10.2 mm]				inches
case material	non-conductive black plastic				
weight			2.7		g

## MECHANICAL DRAWING

units: inches [mm]  
 tolerance: X.XX ±0.01 [±0.25]  
               X.XXX ±0.005 [±0.13]  
 pin section tolerance: ±0.002[±0.05]

PIN CONNECTIONS		
PIN	Function	
	Single	Dual
1	+Vin	+Vin
2	-Vin	-Vin
4	-Vout	-Vout
5	No pin	Common
6	+Vout	+Vout

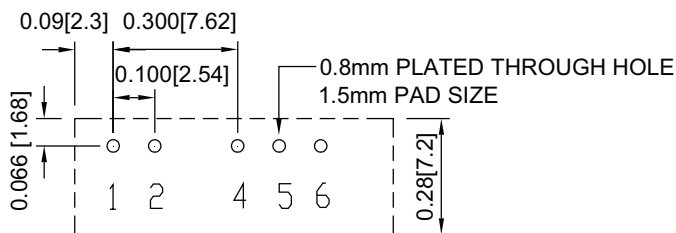
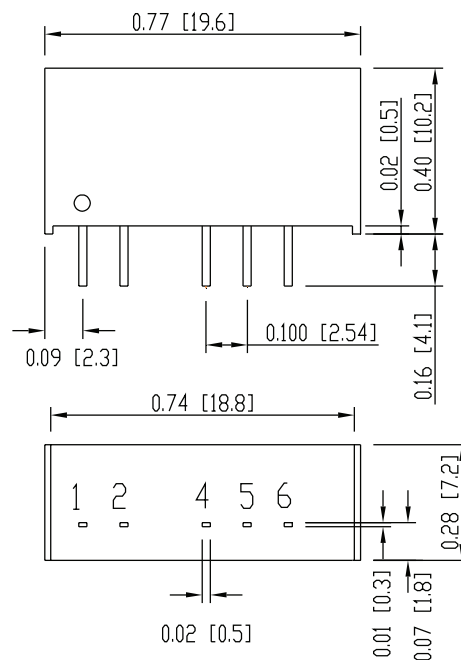

Recommended PCB Layout  
Top View

## DERATING CURVE

### TEMPERATURE DERATING CURVE

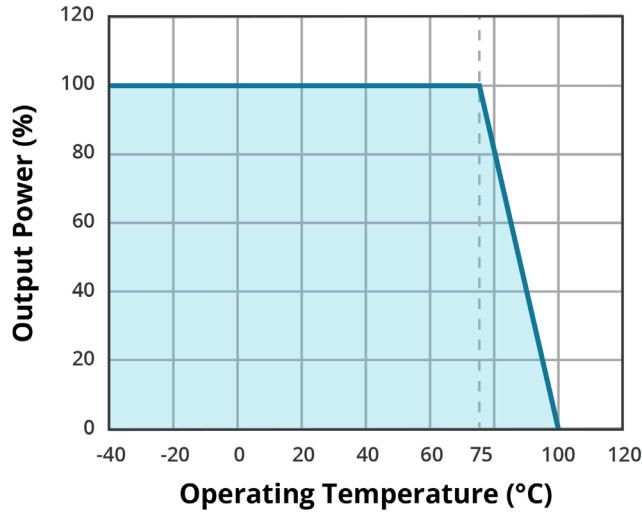

## EFFICIENCY CURVES

**EFFICIENCY VS OUTPUT LOAD  
PCN2-S5-S5-S**

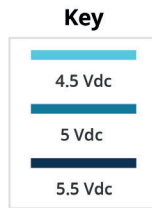
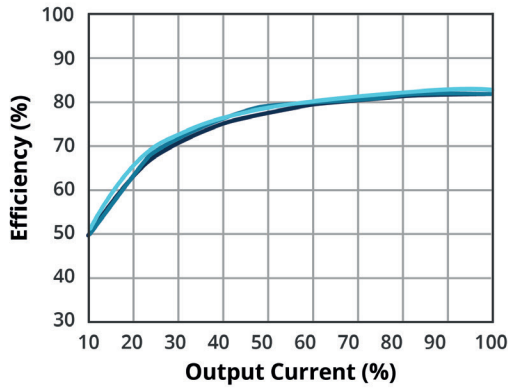

**EFFICIENCY VS OUTPUT LOAD  
PCN2-S5-S12-S**

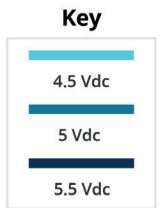
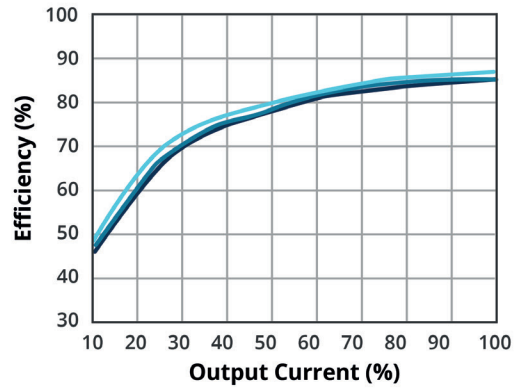

**EFFICIENCY VS OUTPUT LOAD  
PCN2-S5-S15-S**

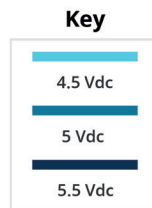
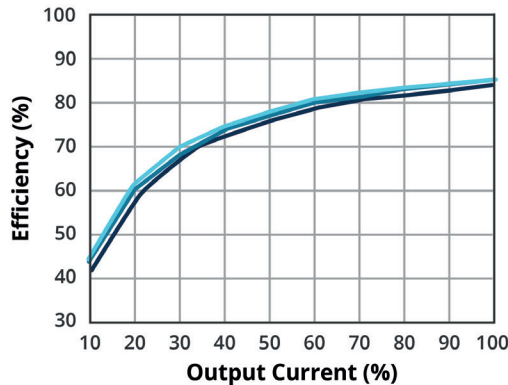

**EFFICIENCY VS OUTPUT LOAD  
PCN2-S5-D5-S**

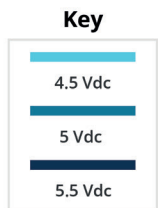
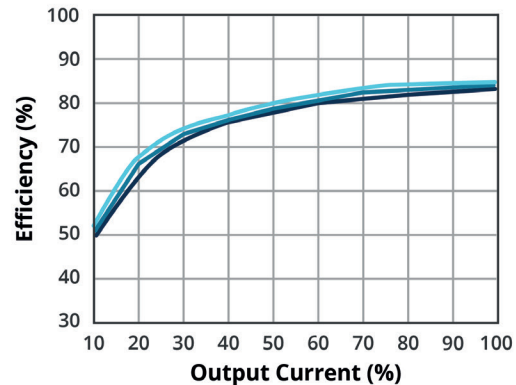

## EFFICIENCY CURVES (CONTINUED)

**EFFICIENCY VS OUTPUT LOAD  
PCN2-S5-D12-S**

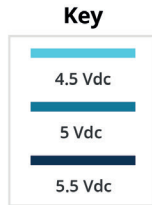
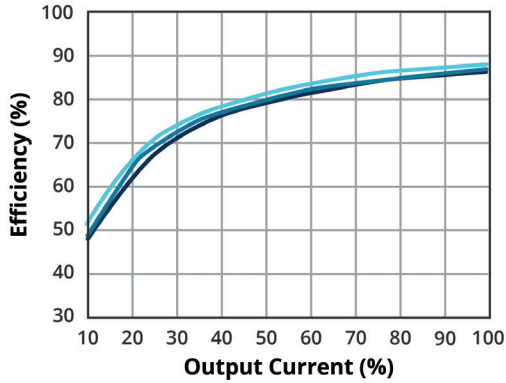

**EFFICIENCY VS OUTPUT LOAD  
PCN2-S5-D15-S**

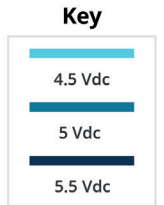
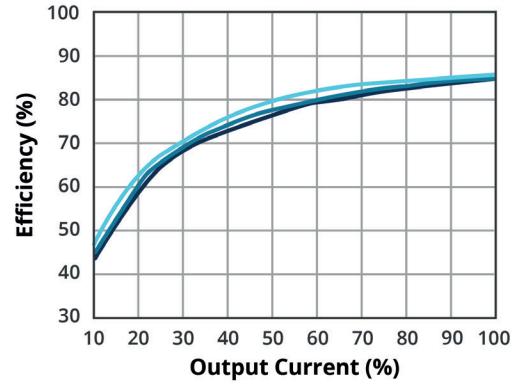

**EFFICIENCY VS OUTPUT LOAD  
PCN2-S12-S5-S**

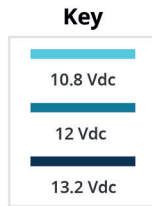
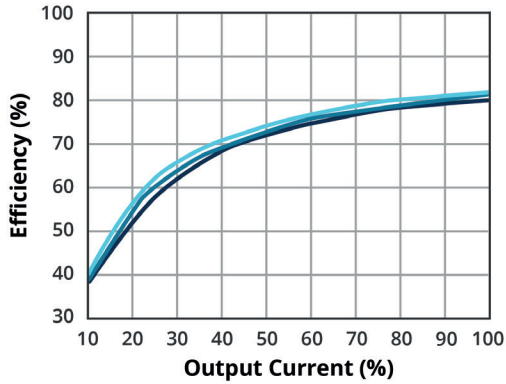

**EFFICIENCY VS OUTPUT LOAD  
PCN2-S12-S12-S**

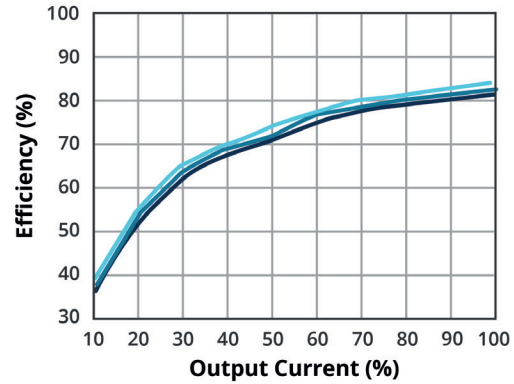

**EFFICIENCY VS OUTPUT LOAD  
PCN2-S12-S15-S**

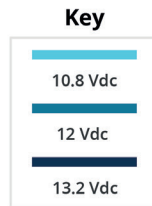
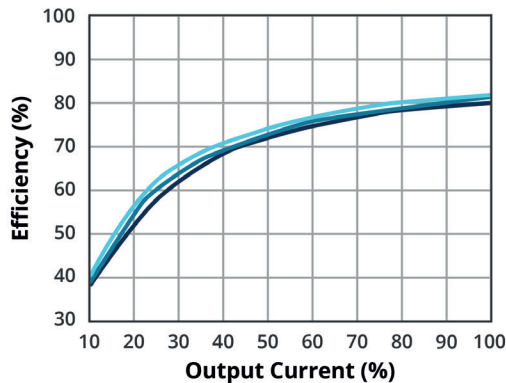

**EFFICIENCY VS OUTPUT LOAD  
PCN2-S12-D5-S**

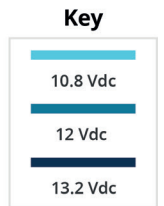
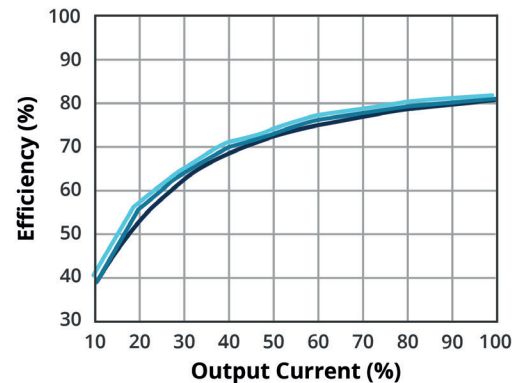

## EFFICIENCY CURVES (CONTINUED)

**EFFICIENCY VS OUTPUT LOAD  
PCN2-S12-D12-S**

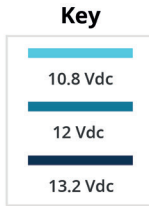
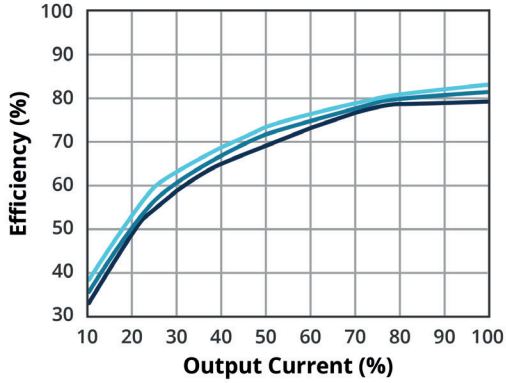

**EFFICIENCY VS OUTPUT LOAD  
PCN2-S12-D15-S**

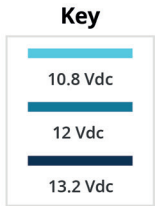
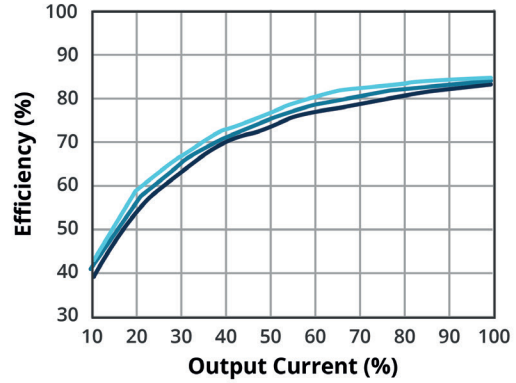

**EFFICIENCY VS OUTPUT LOAD  
PCN2-S24-S5-S**

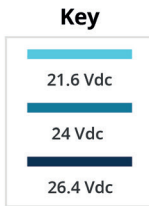
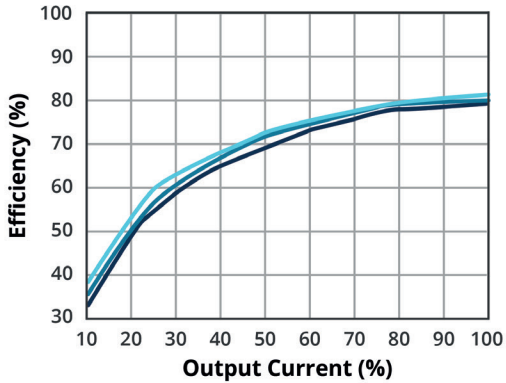

**EFFICIENCY VS OUTPUT LOAD  
PCN2-S24-S12-S**

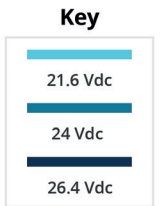
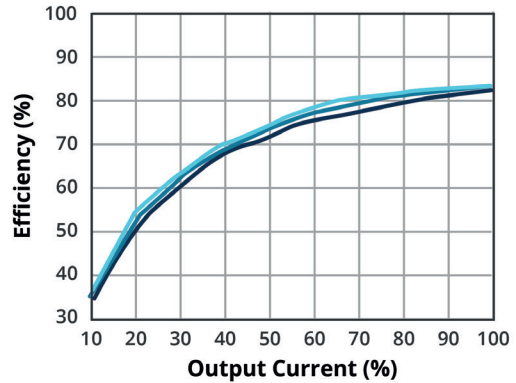

**EFFICIENCY VS OUTPUT LOAD  
PCN2-S24-S15-S**

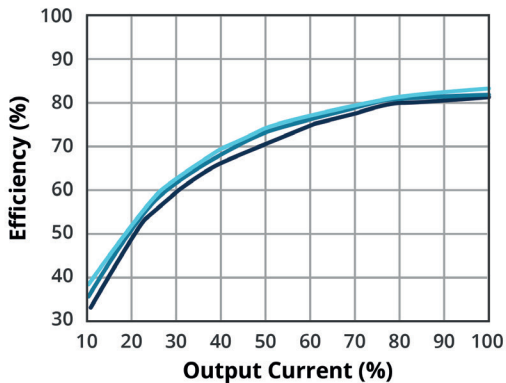

**EFFICIENCY VS OUTPUT LOAD  
PCN2-S24-D5-S**

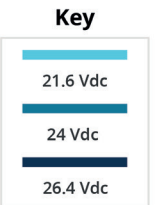
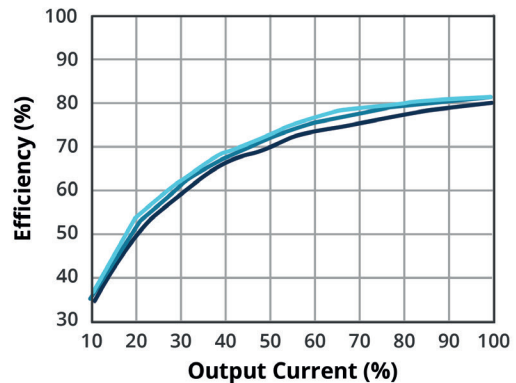

## EFFICIENCY CURVES (CONTINUED)

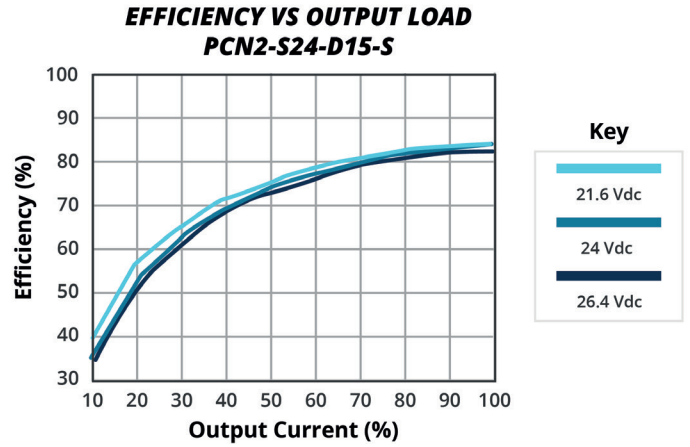
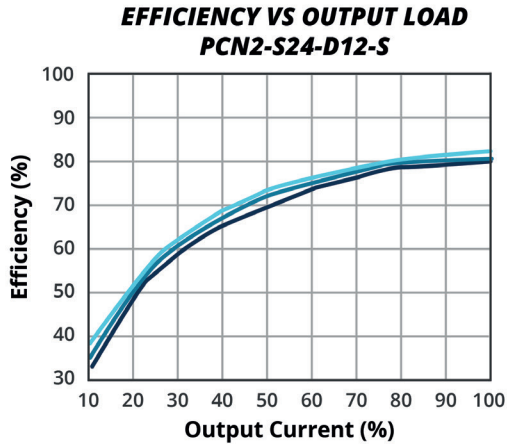

## PACKAGING

units: mm

Tube size: 20 x 11 x 330 mm

QTY: 14 pcs

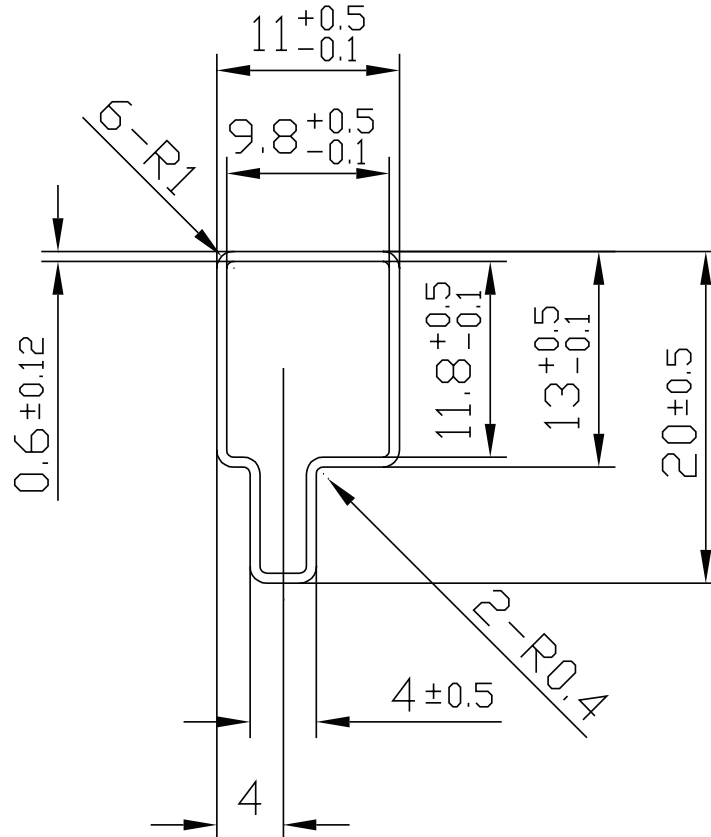

## TEST CONFIGURATIONS

### Input Ripple Current & Output Noise

**Figure 1 Measuring Input Ripple Current**

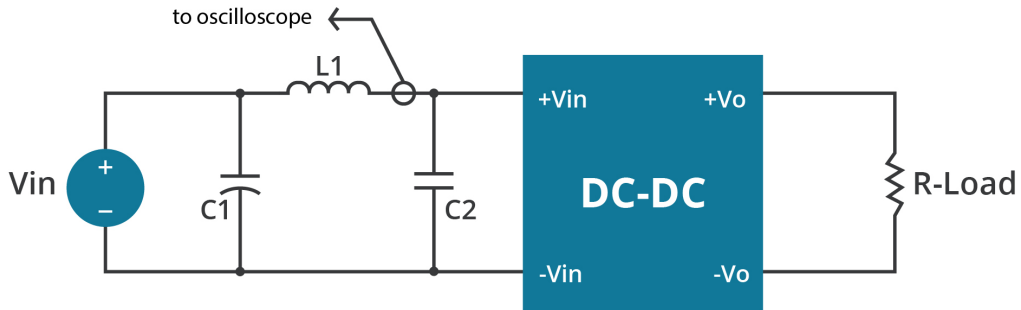

**Table 1**

Input Voltage (Vdc)	L1	C1	C2
5	12 $\mu$ H	2.2 $\mu$ F tantalum capacitor	NC
12	12 $\mu$ H	2.2 $\mu$ F tantalum capacitor	NC
24	12 $\mu$ H	10 $\mu$ F ceramic capacitor	NC

**Figure 2 Measuring Output Ripple & Noise for Single Output Models**

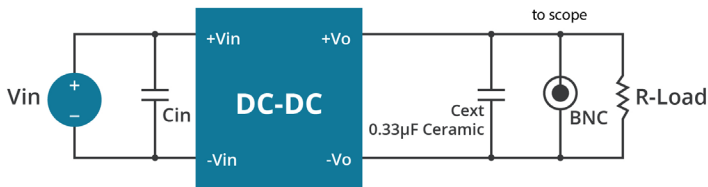

**Figure 3 Measuring Output Ripple & Noise for Dual Output Models**

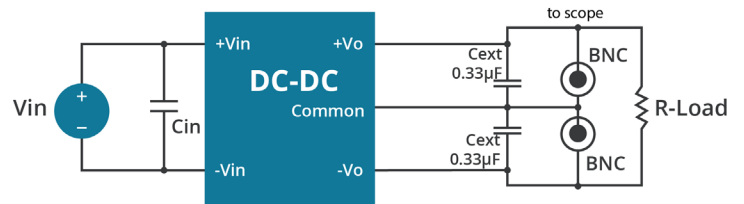

**Table 2**

Input Voltage (Vdc)	Cin
5	2.2 $\mu$ F ceramic capacitor
12	2.2 $\mu$ F ceramic capacitor
24	10 $\mu$ F ceramic capacitor



## EMC RECOMMENDED CIRCUIT

### Test Condition

Input Voltage: Nominal

Output Load: Full Load

Figure 4 Conducted Emissions Test Circuit

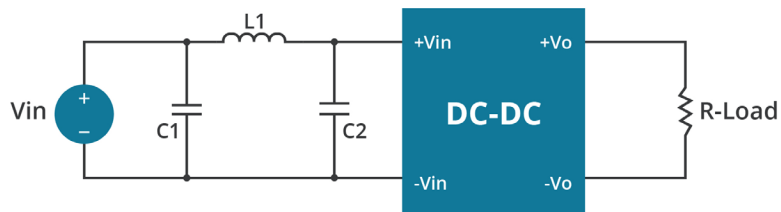

Table 3

EN55022 Class A Recommended External Circuit Components			
Model	C1 <sup>1</sup>	C2 <sup>1</sup>	L1
PCN2-S5-S5-S	4.7 μF / 50 V	NC	2.2 μH
PCN2-S5-S12-S	4.7 μF / 50 V	NC	2.2 μH
PCN2-S5-S15-S	10 μF / 25 V	NC	5.6 μH
PCN2-S5-D5-S	4.7 μF / 50 V	NC	2.2 μH
PCN2-S5-D12-S	4.7 μF / 50 V	NC	2.2 μH
PCN2-S5-D15-S	10 μF / 25 V	NC	5.6 μH
PCN2-S12-S5-S	10 μF / 25 V	NC	5.6 μH
PCN2-S12-S12-S	4.7 μF / 50 V	NC	5.6 μH
PCN2-S12-S15-S	4.7 μF / 50 V	NC	5.6 μH
PCN2-S12-D5-S	10 μF / 25 V	NC	5.6 μH
PCN2-S12-D12-S	4.7 μF / 50 V	NC	5.6 μH
PCN2-S12-D15-S	4.7 μF / 50 V	NC	5.6 μH
PCN2-S24-S5-S	4.7 μF / 50 V	4.7 μF / 50 V	5.6 μH
PCN2-S24-S12-S	4.7 μF / 50 V	4.7 μF / 50 V	5.6 μH
PCN2-S24-S15-S	4.7 μF / 50 V	4.7 μF / 50 V	5.6 μH
PCN2-S24-D5-S	4.7 μF / 50 V	4.7 μF / 50 V	5.6 μH
PCN2-S24-D12-S	4.7 μF / 50 V	4.7 μF / 50 V	5.6 μH
PCN2-S24-D15-S	4.7 μF / 50 V	4.7 μF / 50 V	5.6 μH

Table 4

EN55022 Class B Recommended External Circuit Components			
Model	C1 <sup>1</sup>	C2 <sup>1</sup>	L1
PCN2-S5-S5-S	10 μF / 25 V	NC	5.6 μH
PCN2-S5-S12-S	10 μF / 25 V	NC	5.6 μH
PCN2-S5-S15-S	10 μF / 25 V	10 μF / 25 V	5.6 μH
PCN2-S5-D5-S	10 μF / 25 V	NC	5.6 μH
PCN2-S5-D12-S	10 μF / 25 V	NC	5.6 μH
PCN2-S5-D15-S	10 μF / 25 V	10 μF / 25 V	5.6 μH
PCN2-S12-S5-S	10 μF / 25 V	10 μF / 25 V	5.6 μH
PCN2-S12-S12-S	10 μF / 25 V	10 μF / 25 V	5.6 μH
PCN2-S12-S15-S	10 μF / 25 V	10 μF / 25 V	5.6 μH
PCN2-S12-D5-S	10 μF / 25 V	10 μF / 25 V	5.6 μH
PCN2-S12-D12-S	10 μF / 25 V	10 μF / 25 V	5.6 μH
PCN2-S12-D15-S	10 μF / 25 V	10 μF / 25 V	5.6 μH
PCN2-S24-S5-S	10 μF / 50 V	10 μF / 50 V	5.6 μH
PCN2-S24-S12-S	10 μF / 50 V	10 μF / 50 V	5.6 μH
PCN2-S24-S15-S	10 μF / 50 V	10 μF / 50 V	5.6 μH
PCN2-S24-D5-S	10 μF / 50 V	10 μF / 50 V	5.6 μH
PCN2-S24-D12-S	10 μF / 50 V	10 μF / 50 V	5.6 μH
PCN2-S24-D15-S	10 μF / 50 V	10 μF / 50 V	5.6 μH

Notes: 1. Ceramic Capacitor

Notes: 1. Ceramic Capacitor

## REVISION HISTORY

---

rev.	description	date
1.0	initial release	07/26/2016
1.01	company logo updated	03/30/2021
1.02	derating, efficiency curves and circuit figures updated	07/09/2021

The revision history provided is for informational purposes only and is believed to be accurate.



**CUI INC**  
a bel group

**Headquarters**  
20050 SW 112th Ave.  
Tualatin, OR 97062  
**800.275.4899**

Fax 503.612.2383  
**cui.com**  
techsupport@cui.com

CUI offers a two (2) year limited warranty. Complete warranty information is listed on our website.

CUI reserves the right to make changes to the product at any time without notice. Information provided by CUI is believed to be accurate and reliable. However, no responsibility is assumed by CUI for its use, nor for any infringements of patents or other rights of third parties which may result from its use.

CUI products are not authorized or warranted for use as critical components in equipment that requires an extremely high level of reliability. A critical component is any component of a life support device or system whose failure to perform can be reasonably expected to cause the failure of the life support device or system, or to affect its safety or effectiveness.

## X-ON Electronics

Largest Supplier of Electrical and Electronic Components

*Click to view similar products for [Isolated DC/DC Converters](#) category:*

*Click to view products by [CUI Inc](#) manufacturer:*

Other Similar products are found below :

[ESM6D044440C05AAQ](#) [FMD15.24G](#) [PSL486-7LR](#) [Q48T30020-NBB0](#) [JAHW100Y1](#) [SPB05C-12](#) [SQ24S15033-PS0S](#) [18952](#) [19-130041](#)  
[CE-1003](#) [CE-1004](#) [GQ2541-7R](#) [RDS180245](#) [MAU228](#) [J80-0041NL](#) [DFC15U48D15](#) [XGS-0512](#) [XGS-1205](#) [XGS-1212](#) [XGS-2412](#) [XGS-2415](#) [XKS-1215](#) [06322](#) [NCT1000N040R050B](#) [SPB05B-15](#) [SPB05C-15](#) [L-DA20](#) [DCG40-5G](#) [QME48T40033-PGB0](#) [XKS-2415](#) [XKS-2412](#)  
[XKS-1212](#) [XKS-1205](#) [XKS-0515](#) [XKS-0505](#) [XGS-2405](#) [XGS-1215](#) [XGS-0515](#) [PS9Z-6RM4](#) [73-551-5038I](#) [AK1601-9RT](#) [VI-N61-CM](#) [VI-R5022-EXWW](#) [PSC128-7iR](#) [RPS8-350ATX-XE](#) [DAS1004812](#) [PQA30-D24-S24-DH](#) [VI-M5F-CQ](#) [VI-LN2-EW](#) [VI-PJW01-CZY](#)