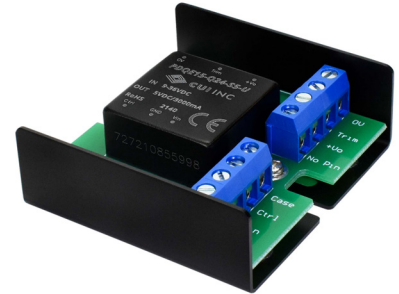

**SERIES: PDQE15-U | DESCRIPTION: DC-DC CONVERTER**
**FEATURES**

- up to 15 W isolated output
- 1,500 Vdc isolation
- ultra-wide 4:1 input range (9~36 Vdc, 18~75 Vdc)
- same side input/output connections
- single/dual regulated outputs
- input under-voltage, output short-circuit, over-current, & over-voltage protections
- wide operating temperature range (-40~105°C)
- efficiency up to 91%
- EN 62368-1
- meets UL 62368

**MODEL**

MODEL	input voltage		output voltage (Vdc)	output current		output power max (W)	ripple & noise <sup>1</sup> max (mVp-p)	efficiency <sup>2</sup> typ (%)
	typ (Vdc)	range (Vdc)		min (mA)	max (mA)			
PDQE15-Q24-D5-U	24	9~36	±5	0	±1500	15	200	87
PDQE15-Q24-D12-U	24	9~36	±12	0	±625	15	200	90
PDQE15-Q24-D15-U	24	9~36	±15	0	±500	15	200	90
PDQE15-Q24-D24-U	24	9~36	±24	0	±312	15	200	89
PDQE15-Q24-S3-U	24	9~36	3.3	0	4000	13.2	100	88
PDQE15-Q24-S5-U	24	9~36	5	0	3000	15	100	90
PDQE15-Q24-S12-U	24	9~36	12	0	1250	15	100	90
PDQE15-Q24-S15-U	24	9~36	15	0	1000	15	100	91
PDQE15-Q24-S24-U	24	9~36	24	0	625	15	100	91
PDQE15-Q48-D5-U	48	18~75	±5	0	±1500	15	200	86
PDQE15-Q48-D12-U	48	18~75	±12	0	±625	15	200	89
PDQE15-Q48-D15-U	48	18~75	±15	0	±500	15	200	89
PDQE15-Q48-D24-U	48	18~75	±24	0	±312	15	200	90
PDQE15-Q48-S3-U	48	18~75	3.3	0	4000	13.2	100	88
PDQE15-Q48-S5-U	48	18~75	5	0	3000	15	100	90
PDQE15-Q48-S12-U	48	18~75	12	0	1250	15	100	91
PDQE15-Q48-S15-U	48	18~75	15	0	1000	15	100	91
PDQE15-Q48-S24-U	48	18~75	24	0	625	15	100	91

- Notes:
1. From 5~100% load, 20 MHz bandwidth oscilloscope, using the "parallel cable" method for testing.  
From 0~5% load, ripple and noise is <math>\pm 5\% V\_o</math>.
  2. Measured at nominal input voltage and rated load.
  3. All specifications are measured at  $T_a=25^\circ\text{C}$ , humidity < 75%, nominal input voltage, and rated output load unless otherwise specified.

## PART NUMBER KEY

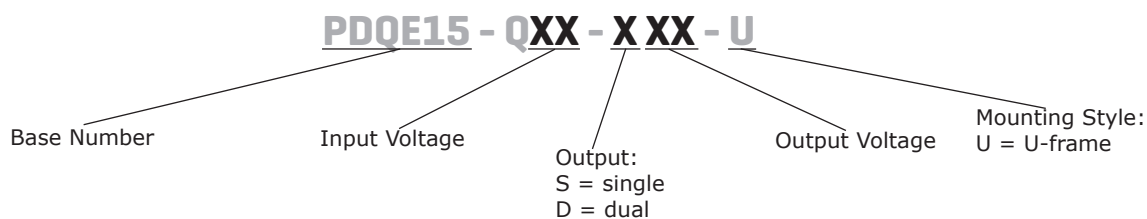

## INPUT

parameter	conditions/description	min	typ	max	units	
operating input voltage	24 Vdc input models	9	24	36	Vdc	
	48 Vdc input models	18	48	75	Vdc	
start-up voltage	24 Vdc input models			9	Vdc	
	48 Vdc input models			18	Vdc	
surge voltage	for maximum of 1 second					
	24 Vdc input models	-0.7		50	Vdc	
	48 Vdc input models	-0.7		100	Vdc	
under voltage shutdown	24 Vdc input models	5.5	6.5		Vdc	
	48 Vdc input models	12	15.5		Vdc	
current (full load/no load)	dual output models	24 Vdc input models		719/10	735/20	mA
		48 Vdc input models		364/5	372/11	mA
	single output models	24 Vdc input models	3.3 Vdc output	625/30	640/50	mA
			5 Vdc output	694/30	710/50	mA
			12 Vdc output	694/6	710/15	mA
			15 Vdc output	687/6	703/15	mA
	24 Vdc output	687/10	703/20	mA		
	48 Vdc input models	3.3 Vdc output	313/15	320/30	mA	
		5 Vdc output	348/15	356/30	mA	
		all other output models	344/3	352/11	mA	
remote on/off (CTRL)	module ON (3.5~12 Vdc or CTRL pin open circuit or pulled high) module OFF (0~1.2 Vdc CTRL pin pulled low to GND) input current when switched off		2	7	mA	
start-up time	nominal input, constant resistance load		10		ms	
filter	Pi filter					

## OUTPUT

parameter	conditions/description	min	typ	max	units
maximum capacitive load <sup>4</sup>	3.3, 5 Vdc output models			4,700	μF
	±5 Vdc output models			1,500	μF
	12 Vdc output models			1,000	μF
	±12 Vdc output models			470	μF
	15 Vdc output models			820	μF
	±15 Vdc output models			330	μF
	24 Vdc output models			270	μF
	±24 Vdc output models			200	μF
voltage accuracy <sup>5</sup>	0% to full load		±1	±3	%
line regulation	from low line to high line, full load				
	positive outputs		±0.2	±0.5	%
	negative outputs		±0.5	±1	%
load regulation <sup>6</sup>	from 5% to full load		±0.5	±1	%

**OUTPUT (CONTINUED)**

parameter	conditions/description	min	typ	max	units
cross regulation	dual output models: positive output 50% load secondary output from 10~100% load			±5	%
switching frequency <sup>7</sup>	PWM mode 3.3, 5 Vdc output models all other output models		300 270		kHz kHz
transient recovery time	25% load step change, nominal input voltage		300	500	µs
transient response deviation	25% load step change, nominal input voltage 3.3, 5 Vdc output models ±5 Vdc output model all other output models		±3 ±3 ±3	±7 ±8 ±5	% % %
temperature coefficient	at full load			±0.03	%/°C

Note: 4. Specified maximum capacitive load for positive and negative outputs is identical.  
5. Output voltage accuracy of ±5 Vdc/±9 Vdc output converter for 0%~5% load is ±5% max.  
6. Load regulation for 0%~100% load is ±5%.  
7. Switching frequency is measured at full load. Module reduces switching frequency at light load (below 50%), to increase efficiency.

**PROTECTIONS**

parameter	conditions/description	min	typ	max	units
over voltage protection		110		160	%
over current protection	single output models dual output models	110 110	150 200	190 270	% %
short circuit protection	continuous, auto recovery				

**SAFETY AND COMPLIANCE**

parameter	conditions/description	min	typ	max	units
isolation voltage	input to output for 1 minute at 1 mA input to output-case for 1 minute at 1 mA	1,500 1,000			Vdc Vdc
isolation resistance	input to output at 500 Vdc	1,000			MΩ
isolation capacitance	input to output, 100 kHz / 0.1 V		2,000		pF
safety approvals	certified to 62368: EN, IEC				
conducted emissions	CISPR32/EN55032 CLASS A (without extra components), CLASS B (see Fig. 3-2) EN50121-3-2 150kHz-500kHz 99dBuV (see Fig. 3-2) EN55016-2-1 500kHz-30MHz 93dBuV (see Fig. 3-2)				
radiated emissions	CISPR32/EN55032 CLASS A (without extra components), CLASS B (see Fig. 3-2) EN50121-3-2 30MHz-230MHz 40dBuV/m at 10m (see Fig. 3-2) EN55016-2-1 230MHz-1GHz 47dBuV/m at 10m (see Fig.3-2)				
ESD	IEC/EN61000-4-2 Contact ±4kV, perf. Criteria B EN50121-3-2 Contact ±6KV/Air ±8KV, perf. Criteria A				
radiated immunity	IEC/EN61000-4-3 10V/m, perf. Criteria A EN50121-3-2 20V/m, perf Criteria A				
EFT/burst	IEC/EN61000-4-4 ±2kV (see Fig. 3-1), perf. Criteria B EN50121-3-2 ±2kV 5/50ns 5kHz (see Fig. 3-1), perf. Criteria A				
surge	IEC/EN61000-4-5 line to line ±2kV (see Fig. 3-1), perf. Criteria B EN50121-3-2 line to line ±1KV (42Ω , 0.5µF) (see Fig. 3-1), perf. Criteria A				
conducted immunity	IEC/EN61000-4-6 3 Vr.m.s, perf. Criteria A EN50121-3-2 0.15MHz-80MHz 10V r.m.s, perf. Criteria A				
MTBF	as per MIL-HDBK-217F, 25°C	1,000,000			hours
RoHS	yes				

## ENVIRONMENTAL

parameter	conditions/description	min	typ	max	units
operating temperature	see derating curve	-40		105	°C
	3.3, 5 Vdc output models	-40		95	°C
storage temperature		-55		125	°C
storage humidity	non-condensing	5		95	%

## DERATING CURVES

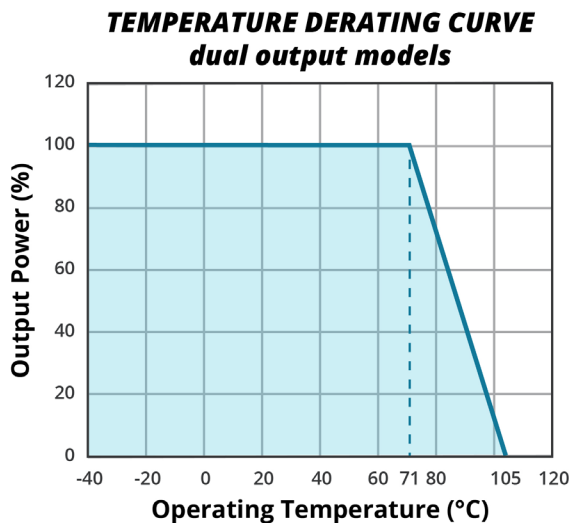
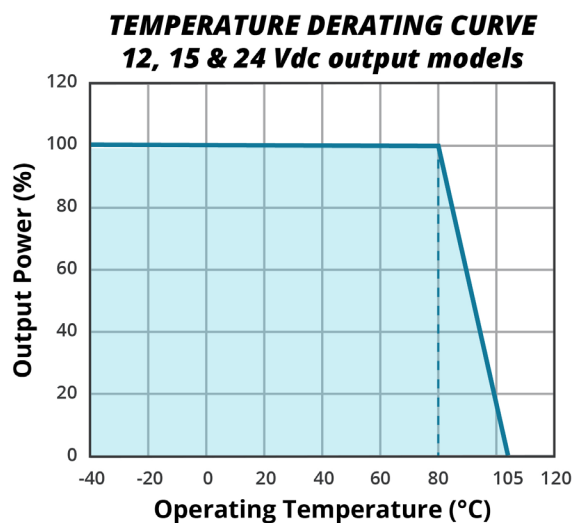
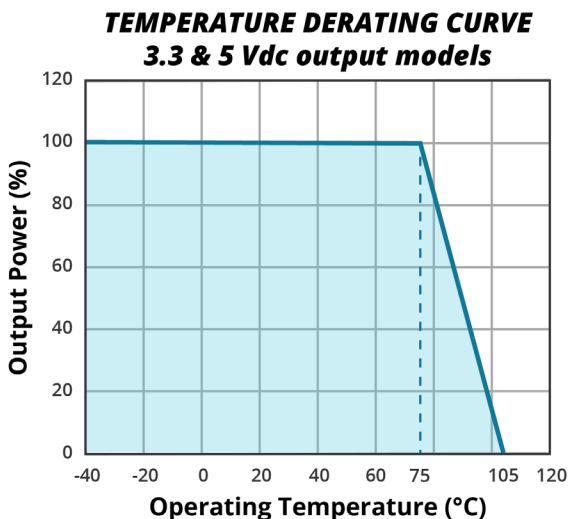

## SOLDERABILITY

parameter	conditions/description	min	typ	max	units
pin soldering resistance temperature	1.5 mm from case for 10 seconds			300	°C

## MECHANICAL

parameter	conditions/description	min	typ	max	units
dimensions	55.00 x 52.30 x 19.00 [2.165 x 2.059 x 0.748 inch]				mm
case material	aluminum alloy				
weight			46		g

## MECHANICAL DRAWING

units: mm [inch]  
 wire range: 24-12 AWG  
 tolerance:  $\pm 1.00[\pm 0.039]$   
 tightening torque: Max 0.4 N·m

PIN CONNECTIONS		
PIN	Function	
	Single	Dual
1	GND	GND
2	Vin	Vin
3	Ctrl	Ctrl
4	Case	Case
5	NC	NC
6	+Vo	+Vo
7	Trim	0V
8	0V	-Vo

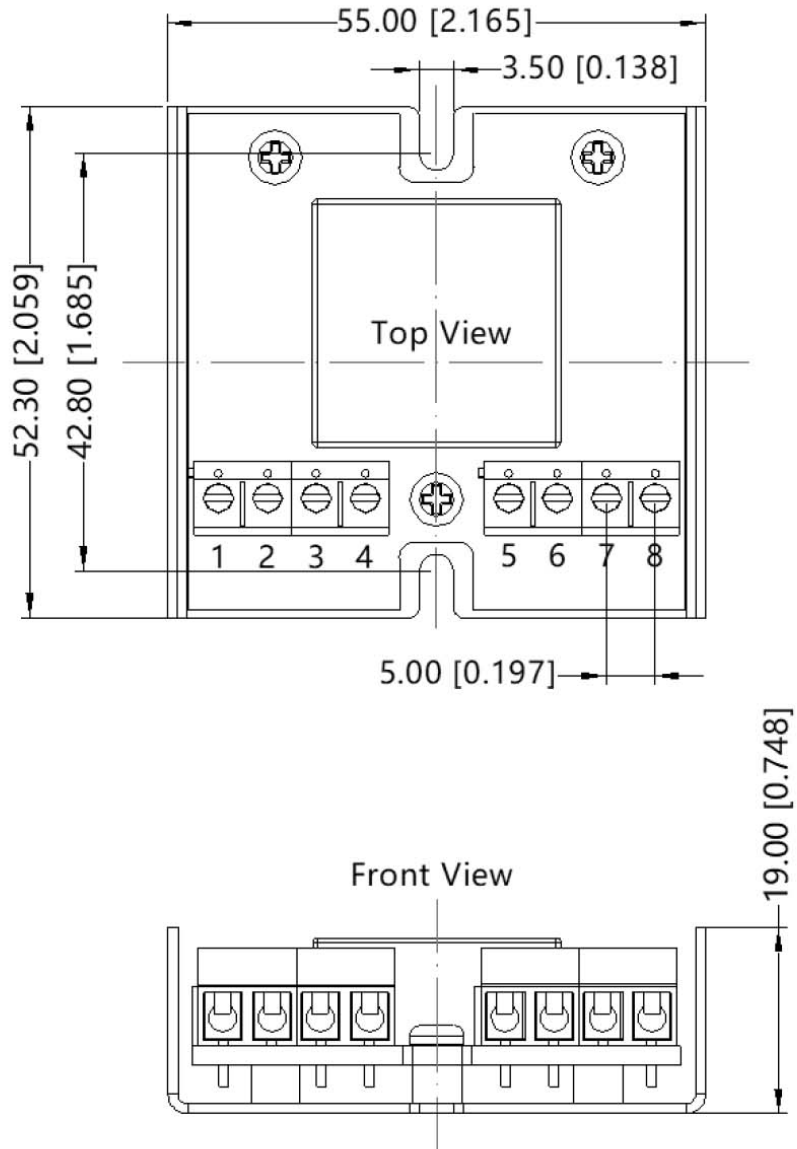

## EFFICIENCY CURVES

**EFFICIENCY VS INPUT VOLTAGE**  
**PDQE15-Q24-D5-U**  
*(full load)*

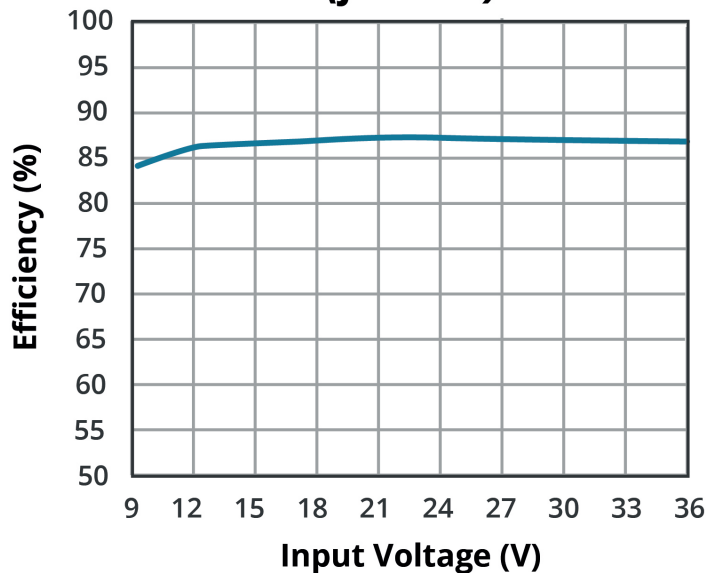

**EFFICIENCY VS OUTPUT LOAD**  
**PDQE15-Q24-D5-U**  
*(Vin = 24V)*

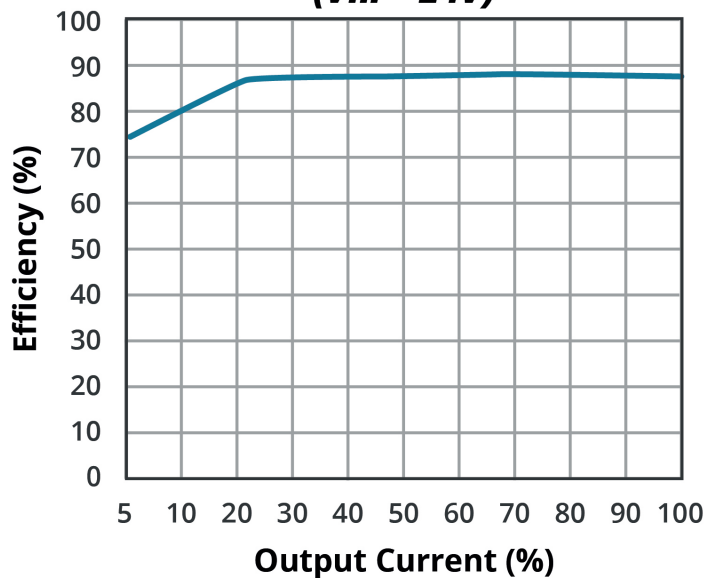

**EFFICIENCY VS INPUT VOLTAGE**  
**PDQE15-Q48-D24-U**  
*(full load)*

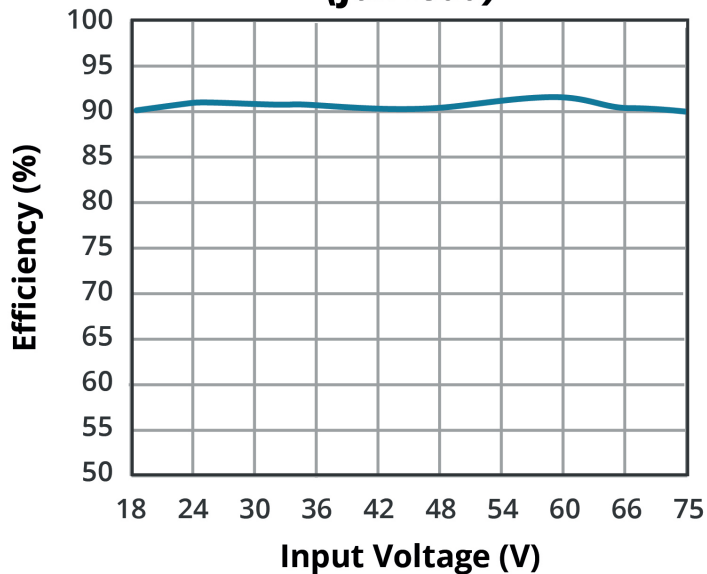

**EFFICIENCY VS OUTPUT LOAD**  
**PDQE15-Q48-D24-U**  
*(Vin = 48V)*

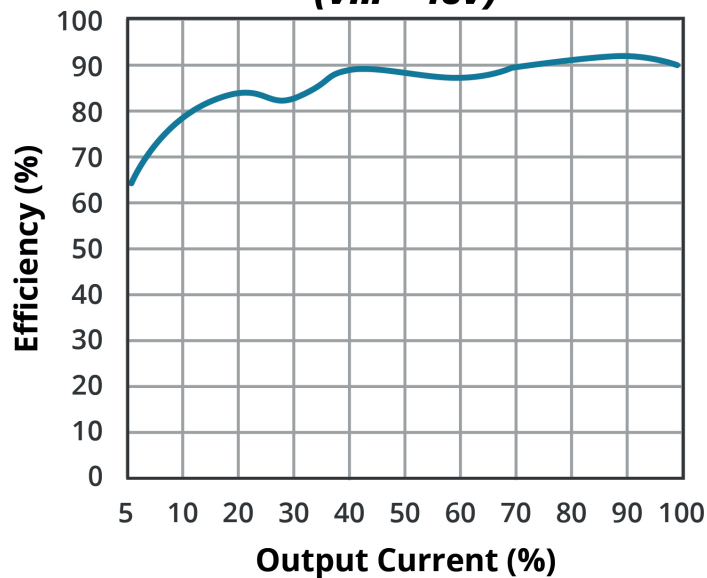

## EFFICIENCY CURVES (CONTINUED)

**EFFICIENCY VS INPUT VOLTAGE**  
**PDQE15-Q24-S5-U**  
*(full load)*

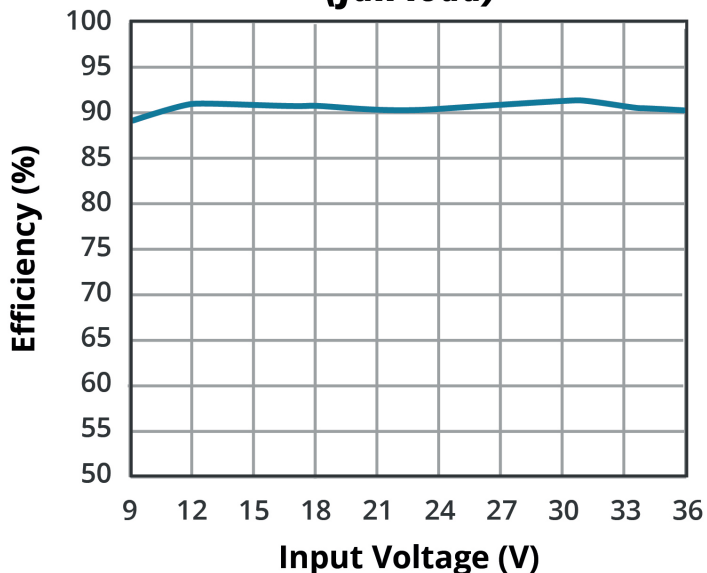

**EFFICIENCY VS OUTPUT LOAD**  
**PDQE15-Q24-S5-U**  
*(Vin = 24V)*

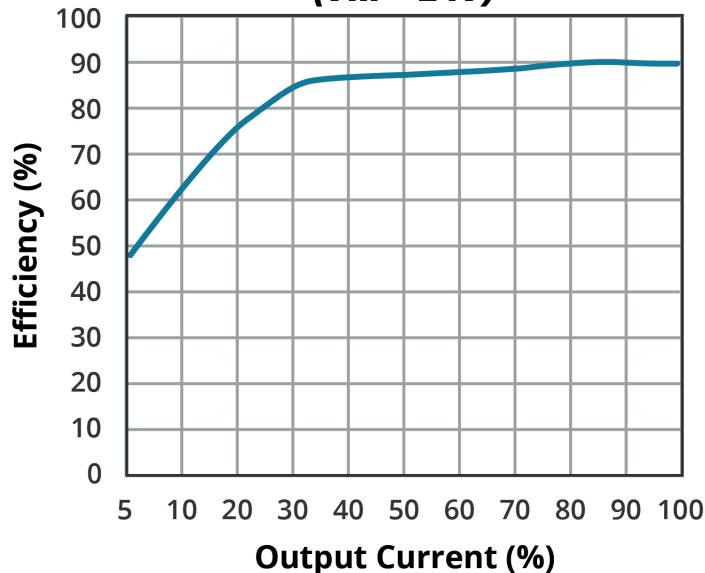

**EFFICIENCY VS INPUT VOLTAGE**  
**PDQE15-Q48-S5-U**  
*(full load)*

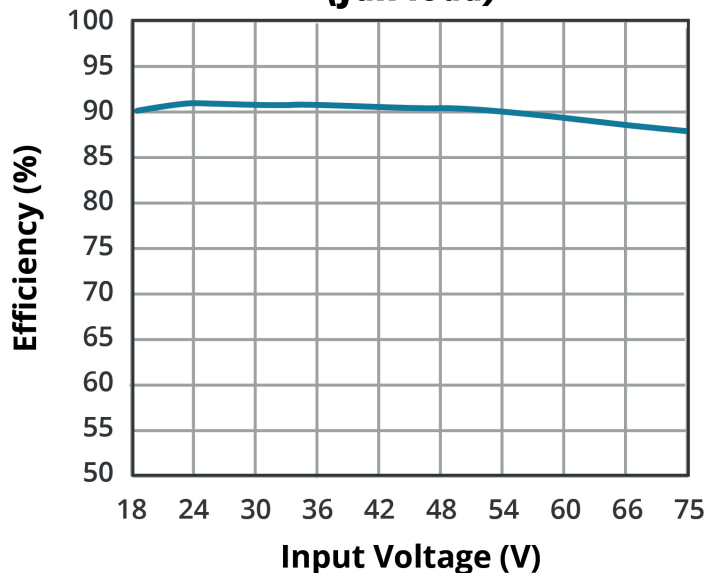

**EFFICIENCY VS OUTPUT LOAD**  
**PDQE15-Q48-S5-U**  
*(Vin = 48V)*

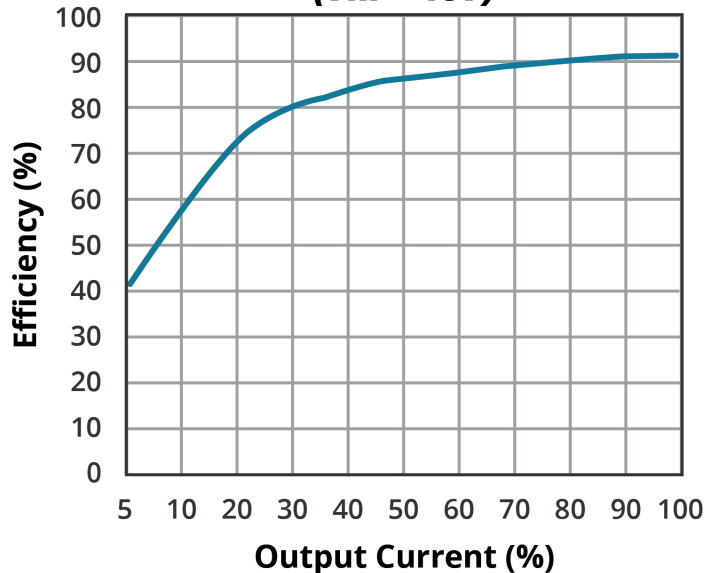

## APPLICATION CIRCUIT

This series has been tested according to the following recommended circuits (Figures 1 & 2) before leaving the factory. If you want to further reduce the input and output ripple, you can increase the input and output capacitors or select capacitors of low equivalent series resistance (ESR) provided that the capacitance is less than the maximum capacitive load of the model.

**Figure 1**  
Single Output Models

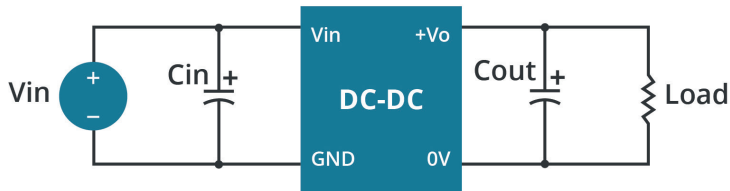

**Figure 2**  
Dual Output Models

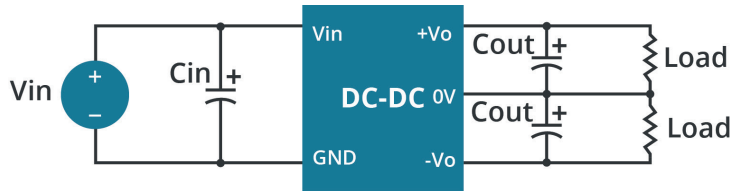
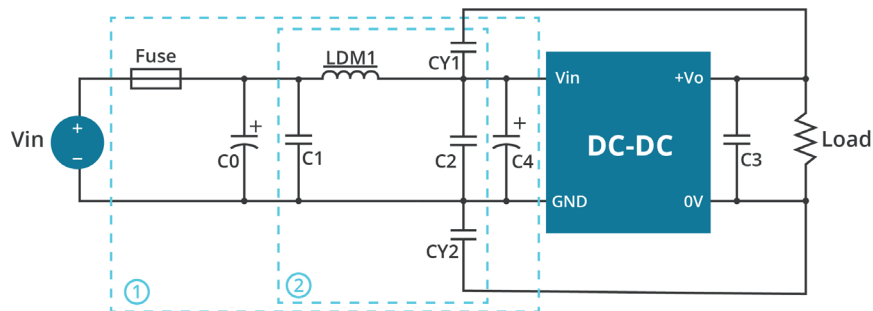

**Table 1**

Vin (Vdc)	Cin (μF/V)	Vout (Vdc)	Cout (μF/V)
24	100/50	±5	10/16
		±12/±15	10/25
		±24	10/50
		3.3/5	100/16
		12/15	100/25
		24	47/50
48	10~47/100	±5	10/16
		±12/±15	10/25
		±24	10/50
		3.3/5	100/16
		12/15	100/25
		24	47/50

## EMC RECOMMENDED CIRCUIT

**Figure 3**



**Table 2**

Recommended External Circuit Components		
Vin (Vdc)	24	48
FUSE	T/ 2.5A / 250Vac	T/ 1.6A / 250Vac
C0/C4	330μF / 50V	330μF / 100V
C1/C2	4.7μF / 50V	4.7μF / 100V
C3	refer to the Cout in Figure 1 & 2	
LDM1 single / dual	2.2μH/4A / 4.7μH	
CY1, CY2	1nF / 2kV	



## TRIM FUNCTION

Figure 4

Trim Function for Output Voltage Adjustment (open if unused)

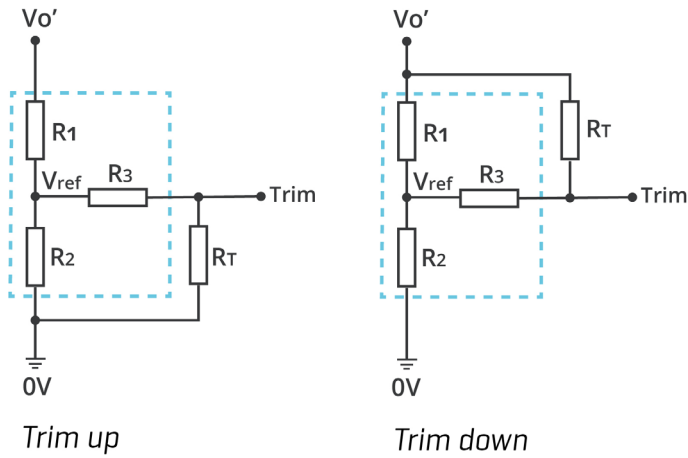

Calculating Trim Resistor Values:

$$RT = \frac{a R2}{R2 - a} - R3$$

$$a = \frac{Vref}{Vo' - Vref} \cdot R1$$

$$RT = \frac{a R1}{R1 - a} - R3$$

$$a = \frac{Vo' - Vref}{Vref} \cdot R2$$

Note:  
 RT = Trim Resistance  
 a = Self-defined parameter with no real meaning

Table 3

Vout (V)	R1 (kΩ)	R2 (kΩ)	R3 (kΩ)	Vref (V)
3.3	4.801	2.87	15	1.24
5	2.894		10	2.5
12	11.000		17.4	
15	14.494		20	
24	24.872			

## REVISION HISTORY

---

rev.	description	date
1.0	initial release	12/06/2021

The revision history provided is for informational purposes only and is believed to be accurate.



**CUI INC**  
a bel group

**Headquarters**  
20050 SW 112th Ave.  
Tualatin, OR 97062  
**800.275.4899**

Fax 503.612.2383  
**cui.com**  
techsupport@cui.com

CUI offers a two (2) year limited warranty. Complete warranty information is listed on our website.

CUI reserves the right to make changes to the product at any time without notice. Information provided by CUI is believed to be accurate and reliable. However, no responsibility is assumed by CUI for its use, nor for any infringements of patents or other rights of third parties which may result from its use.

CUI products are not authorized or warranted for use as critical components in equipment that requires an extremely high level of reliability. A critical component is any component of a life support device or system whose failure to perform can be reasonably expected to cause the failure of the life support device or system, or to affect its safety or effectiveness.

## X-ON Electronics

Largest Supplier of Electrical and Electronic Components

*Click to view similar products for [Isolated DC/DC Converters](#) category:*

*Click to view products by [CUI Inc](#) manufacturer:*

Other Similar products are found below :

[ESM6D044440C05AAQ](#) [FMD15.24G](#) [PSL486-7LR](#) [Q48T30020-NBB0](#) [JAHW100Y1](#) [SPB05C-12](#) [SQ24S15033-PS0S](#) [18952](#) [19-130041](#)  
[CE-1003](#) [CE-1004](#) [GQ2541-7R](#) [RDS180245](#) [MAU228](#) [J80-0041NL](#) [DFC15U48D15](#) [XGS-0512](#) [XGS-1205](#) [XGS-1212](#) [XGS-2412](#) [XGS-](#)  
[2415](#) [XKS-1215](#) [06322](#) [NCT1000N040R050B](#) [SPB05B-15](#) [SPB05C-15](#) [L-DA20](#) [DCG40-5G](#) [QME48T40033-PGB0](#) [XKS-2415](#) [XKS-2412](#)  
[XKS-1212](#) [XKS-1205](#) [XKS-0515](#) [XKS-0505](#) [XGS-2405](#) [XGS-1215](#) [XGS-0515](#) [PS9Z-6RM4](#) [73-551-5038I](#) [AK1601-9RT](#) [VI-R5022-](#)  
[EXWW](#) [PSC128-7iR](#) [RPS8-350ATX-XE](#) [DAS1004812](#) [VI-LJ11-iz](#) [PQA30-D24-S24-DH](#) [VI-LN2-EW](#) [VI-PJW01-CZY](#) [CK2540-9ERT](#)