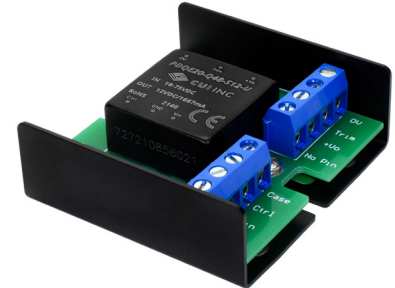

SERIES: PDQE20-U | DESCRIPTION: DC-DC CONVERTER
FEATURES

- up to 20 W isolated output
- 1,500 Vdc isolation
- ultra-wide 4:1 input range (9~36 Vdc, 18~75 Vdc)
- same side input/output connections
- single/dual regulated outputs
- input under-voltage, output short-circuit, over-current, & over-voltage protections
- wide operating temperature range (-40~105°C)
- efficiency up to 91%
- EN 62368-1
- meets UL 62368

MODEL

| MODEL | input voltage | | output voltage (Vdc) | output current | | output power max (W) | ripple & noise ¹ max (mVp-p) | efficiency ² typ (%) |
|------------------|---------------|----------------|-------------------------|----------------|-------------|----------------------------|---|---------------------------------------|
| | typ (Vdc) | range (Vdc) | | min (mA) | max (mA) | | | |
| PDQE20-Q24-D5-U | 24 | 9~36 | ±5 | 0 | ±2000 | 20 | 200 | 87 |
| PDQE20-Q24-D12-U | 24 | 9~36 | ±12 | 0 | ±833 | 20 | 200 | 90 |
| PDQE20-Q24-D15-U | 24 | 9~36 | ±15 | 0 | ±667 | 20 | 200 | 90 |
| PDQE20-Q24-D24-U | 24 | 9~36 | ±24 | 0 | ±417 | 20 | 200 | 89 |
| PDQE20-Q24-S3-U | 24 | 9~36 | 3.3 | 0 | 5000 | 16.5 | 100 | 88 |
| PDQE20-Q24-S5-U | 24 | 9~36 | 5 | 0 | 4000 | 20 | 100 | 90 |
| PDQE20-Q24-S6-U | 24 | 9~36 | 6 | 0 | 3333 | 20 | 100 | 89 |
| PDQE20-Q24-S12-U | 24 | 9~36 | 12 | 0 | 1667 | 20 | 100 | 90 |
| PDQE20-Q24-S15-U | 24 | 9~36 | 15 | 0 | 1333 | 20 | 100 | 91 |
| PDQE20-Q24-S24-U | 24 | 9~36 | 24 | 0 | 833 | 20 | 100 | 91 |
| PDQE20-Q48-D5-U | 48 | 18~75 | ±5 | 0 | ±2000 | 20 | 200 | 86 |
| PDQE20-Q48-D12-U | 48 | 18~75 | ±12 | 0 | ±833 | 20 | 200 | 90 |
| PDQE20-Q48-D15-U | 48 | 18~75 | ±15 | 0 | ±667 | 20 | 200 | 90 |
| PDQE20-Q48-D24-U | 48 | 18~75 | ±24 | 0 | ±417 | 20 | 200 | 90 |
| PDQE20-Q48-S3-U | 48 | 18~75 | 3.3 | 0 | 5000 | 16.5 | 100 | 88 |
| PDQE20-Q48-S5-U | 48 | 18~75 | 5 | 0 | 4000 | 20 | 100 | 90 |
| PDQE20-Q48-S12-U | 48 | 18~75 | 12 | 0 | 1667 | 20 | 100 | 91 |
| PDQE20-Q48-S15-U | 48 | 18~75 | 15 | 0 | 1333 | 20 | 100 | 91 |
| PDQE20-Q48-S24-U | 48 | 18~75 | 24 | 0 | 833 | 20 | 100 | 91 |

- Notes:
1. From 5~100% load, 20 MHz bandwidth oscilloscope, using the "parallel cable" method for testing.
From 0~5% load, ripple and noise is <5% Vo.
 2. Measured at nominal input voltage and rated load.
 3. All specifications are measured at Ta=25°C, humidity < 75%, nominal input voltage, and rated output load unless otherwise specified.

PART NUMBER KEY

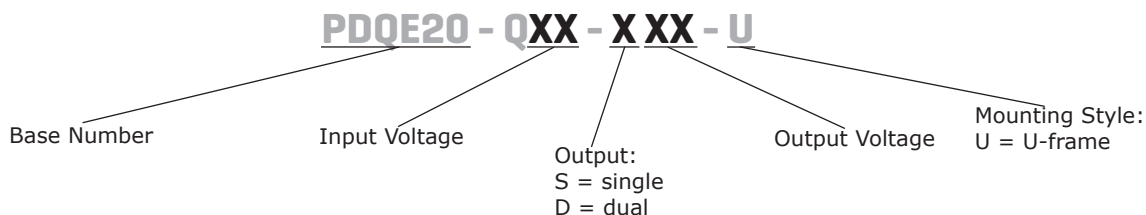

INPUT

| parameter | conditions/description | min | typ | max | units | |
|-----------------------------|--|---------------------|-------|--------|--------|----|
| operating input voltage | 24 Vdc input models | 9 | 24 | 36 | Vdc | |
| | 48 Vdc input models | 18 | 48 | 75 | Vdc | |
| start-up voltage | 24 Vdc input models | | | 9 | Vdc | |
| | 48 Vdc input models | | | 18 | Vdc | |
| surge voltage | for maximum of 1 second | | | | | |
| | 24 Vdc input models | -0.7 | | 50 | Vdc | |
| | 48 Vdc input models | -0.7 | | 100 | Vdc | |
| under voltage shutdown | 24 Vdc input models | 5.5 | 6.5 | | Vdc | |
| | 48 Vdc input models | 12 | 15.5 | | Vdc | |
| current (full load/no load) | dual output models | 24 Vdc input models | | 958/10 | 980/20 | mA |
| | | 48 Vdc input models | | 484/5 | 496/11 | mA |
| | 24 Vdc input models | 3.3 Vdc output | | 782/30 | 800/50 | mA |
| | | 5 Vdc output | | 926/35 | 947/55 | mA |
| | | 6 Vdc output | | 936/50 | 958/70 | mA |
| | | 12 Vdc output | | 926/6 | 947/15 | mA |
| | | 15 Vdc output | | 916/6 | 937/15 | mA |
| | | 24 Vdc output | | 916/10 | 937/20 | mA |
| | single output models | 3.3 Vdc output | | 391/15 | 400/30 | mA |
| | | 5 Vdc output | | 463/20 | 474/30 | mA |
| 12, 15 Vdc output | | | 458/3 | 469/15 | mA | |
| 24 Vdc output | | | 458/4 | 469/15 | mA | |
| remote on/off (CTRL) | module ON (3.5~12 Vdc or CTRL pin open circuit or pulled high) | | | | | |
| | module OFF (0~1.2 Vdc CTRL pin pulled low to GND) input current when switched off | | 2 | 7 | mA | |
| start-up time | nominal input, constant resistance load | | 10 | | ms | |
| filter | Pi filter | | | | | |

OUTPUT

| parameter | conditions/description | min | typ | max | units |
|--------------------------------------|---------------------------------------|-----|------|--------|-------|
| maximum capacitive load ⁴ | 3.3, 5, 6 Vdc output models | | | 10,000 | μF |
| | ±5 Vdc output models | | | 2,000 | μF |
| | 12 Vdc output models | | | 1,600 | μF |
| | ±12 Vdc output models | | | 800 | μF |
| | 15 Vdc output models | | | 1,000 | μF |
| | ±15 Vdc output models | | | 600 | μF |
| | 24 Vdc output models | | | 500 | μF |
| | ±24 Vdc output models | | | 300 | μF |
| voltage accuracy ⁵ | 0% to full load | | ±1 | ±3 | % |
| line regulation | from low line to high line, full load | | | | |
| | positive outputs | | ±0.2 | ±0.5 | % |
| | negative outputs | | ±0.4 | ±1 | % |
| load regulation ⁶ | from 5% to full load | | ±0.5 | ±1 | % |

OUTPUT (CONTINUED)

| parameter | conditions/description | min | typ | max | units |
|----------------------------------|--|-----|------------|----------|------------|
| cross regulation | dual output models: positive output 50% load secondary output from 10~100% load | | | ±5 | % |
| switching frequency ⁷ | PWM mode 3.3, 5, 6 Vdc output models all other output models | | 300 270 | | kHz kHz |
| transient recovery time | 25% load step change, nominal input voltage | | 300 | 500 | µs |
| transient response deviation | 25% load step change, nominal input voltage 3.3, 5, ±5, 6 Vdc output model all other output models | | ±3 ±3 | ±8 ±5 | % % |
| temperature coefficient | at full load | | | ±0.03 | %/°C |

Note: 4. Specified maximum capacitive load for positive and negative outputs is identical.
5. Output voltage accuracy of dual output models for 0%~5% load is ±4%.
6. Load regulation for 0%~100% load is ±5%.
7. Switching frequency is measured at full load. Module reduces switching frequency at light load (below 50%), to increase efficiency.

PROTECTIONS

| parameter | conditions/description | min | typ | max | units |
|--------------------------|--|------------|------------|------------|--------|
| over voltage protection | | 110 | | 160 | % |
| over current protection | single output models dual output models | 110 110 | 150 150 | 190 200 | % % |
| short circuit protection | continuous, auto recovery | | | | |

SAFETY AND COMPLIANCE

| parameter | conditions/description | min | typ | max | units |
|-----------------------|---|----------------|-------|-----|------------|
| isolation voltage | input to output for 1 minute at 1 mA input to output-case for 1 minute at 1 mA | 1,500 1,000 | | | Vdc Vdc |
| isolation resistance | input to output at 500 Vdc | 1,000 | | | MΩ |
| isolation capacitance | input to output, 100 kHz / 0.1 V | | 2,000 | | pF |
| safety approvals | certified to 62368: EN, IEC | | | | |
| conducted emissions | CISPR32/EN55032 CLASS B (see Fig. 3-2) EN50121-3-2 150kHz-500kHz 99dBuV (see Fig. 3-2) EN55016-2-1 500kHz-30MHz 93dBuV (see Fig. 3-2) | | | | |
| radiated emissions | CISPR32/EN55032 CLASS B (see Fig. 3-2) EN50121-3-2 30MHz-230MHz 40dBuV/m at 10m (see Fig. 3-2) EN55016-2-1 230MHz-1GHz 47dBuV/m at 10m (see Fig. 3-2) | | | | |
| ESD | IEC/EN61000-4-2 Contact ±4kV, perf. Criteria B EN50121-3-2 Contact ±6kV/Air ±8kV, perf. Criteria A | | | | |
| radiated immunity | IEC/EN61000-4-3 10V/m, perf. Criteria A EN50121-3-2 20V/m, perf. Criteria A | | | | |
| EFT/burst | IEC/EN61000-4-4 ±2kV (see Fig. 3-1), perf. Criteria B EN50121-3-2 ±2kV 5/50ns 5kHz (see Fig. 3-1), perf. Criteria A | | | | |
| surge | IEC/EN61000-4-4 ±2kV (see Fig. 3-1), perf. Criteria B EN50121-3-2 line to line ±1kV (42Ω, 0.5µF) (see Fig. 3-1), perf. Criteria A | | | | |
| conducted immunity | IEC/EN61000-4-6 3 Vr.m.s, perf. Criteria A EN50121-3-2 0.15MHz-80MHz 10V r.m.s, perf. Criteria A | | | | |
| MTBF | as per MIL-HDBK-217F, 25°C | 1,000,000 | | | hours |
| RoHS | yes | | | | |

ENVIRONMENTAL

| parameter | conditions/description | min | typ | max | units |
|-----------------------|---|-----|-----|-----|-------|
| operating temperature | see derating curve | -40 | | 95 | °C |
| | 3.3, 5, 6 Vdc output all other output models | -40 | | 105 | °C |
| storage temperature | | -55 | | 125 | °C |
| storage humidity | non-condensing | 5 | | 95 | % |

DERATING CURVES

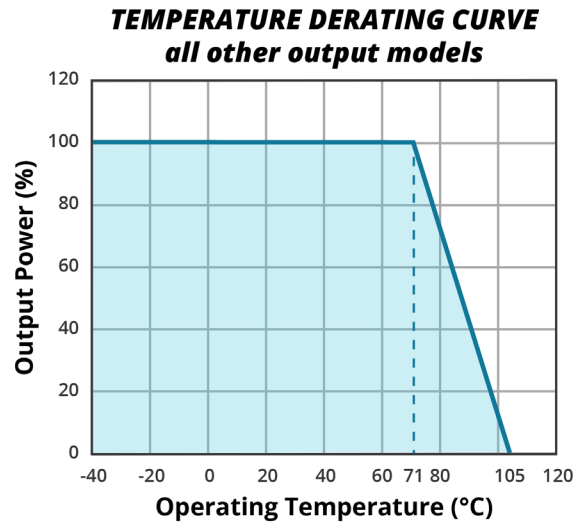
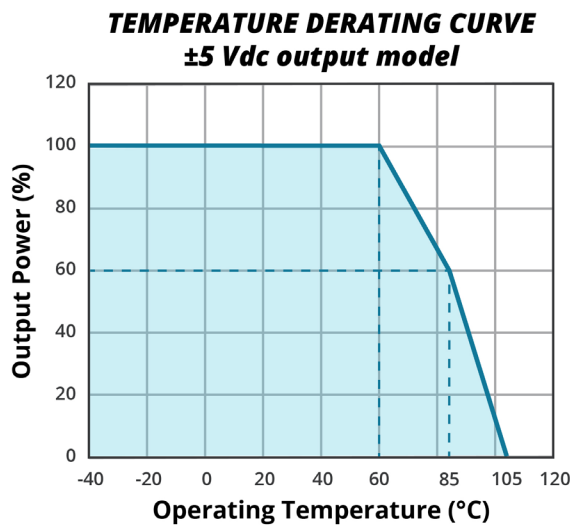
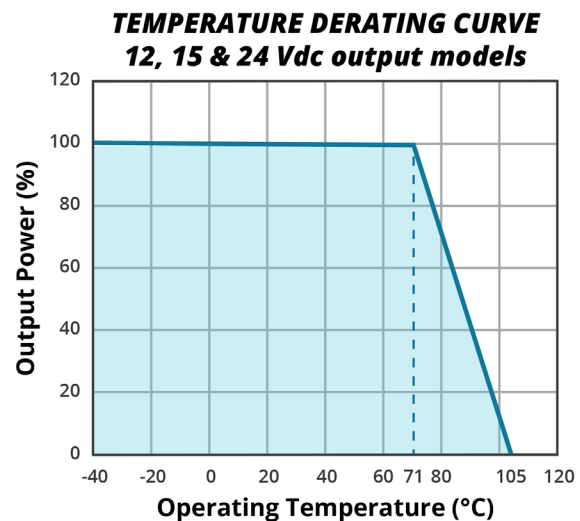
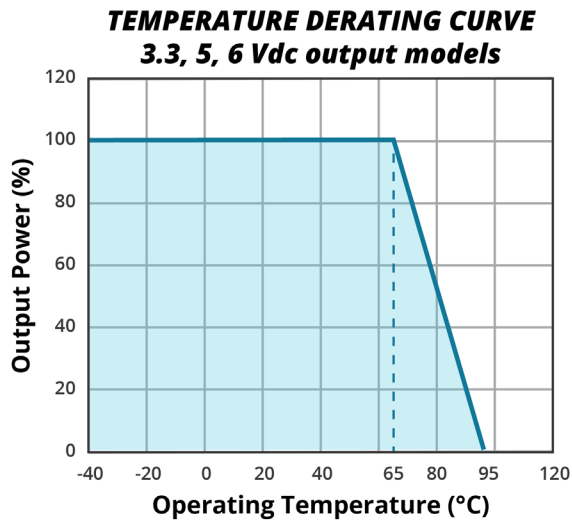

SOLDERABILITY

| parameter | conditions/description | min | typ | max | units |
|--------------------------------------|---------------------------------|-----|-----|-----|-------|
| pin soldering resistance temperature | 1.5 mm from case for 10 seconds | | | 300 | °C |

MECHANICAL

| parameter | conditions/description | min | typ | max | units |
|---------------|--|-----|-----|-----|-------|
| dimensions | 55.00 x 52.30 x 19.00 [2.165 x 2.059 x 0.748 inch] | | | | mm |
| case material | aluminum alloy | | | | |
| weight | | | 46 | | g |

MECHANICAL DRAWING

units: mm [inch]
 wire range: 24-12 AWG
 tolerance: $\pm 1.00[\pm 0.039]$
 tightening torque: Max 0.4 N·m

| PIN CONNECTIONS | | |
|-----------------|----------|------|
| PIN | Function | |
| | Single | Dual |
| 1 | GND | GND |
| 2 | Vin | Vin |
| 3 | Ctrl | Ctrl |
| 4 | Case | Case |
| 5 | NC | NC |
| 6 | +Vo | +Vo |
| 7 | Trim | 0V |
| 8 | 0V | -Vo |

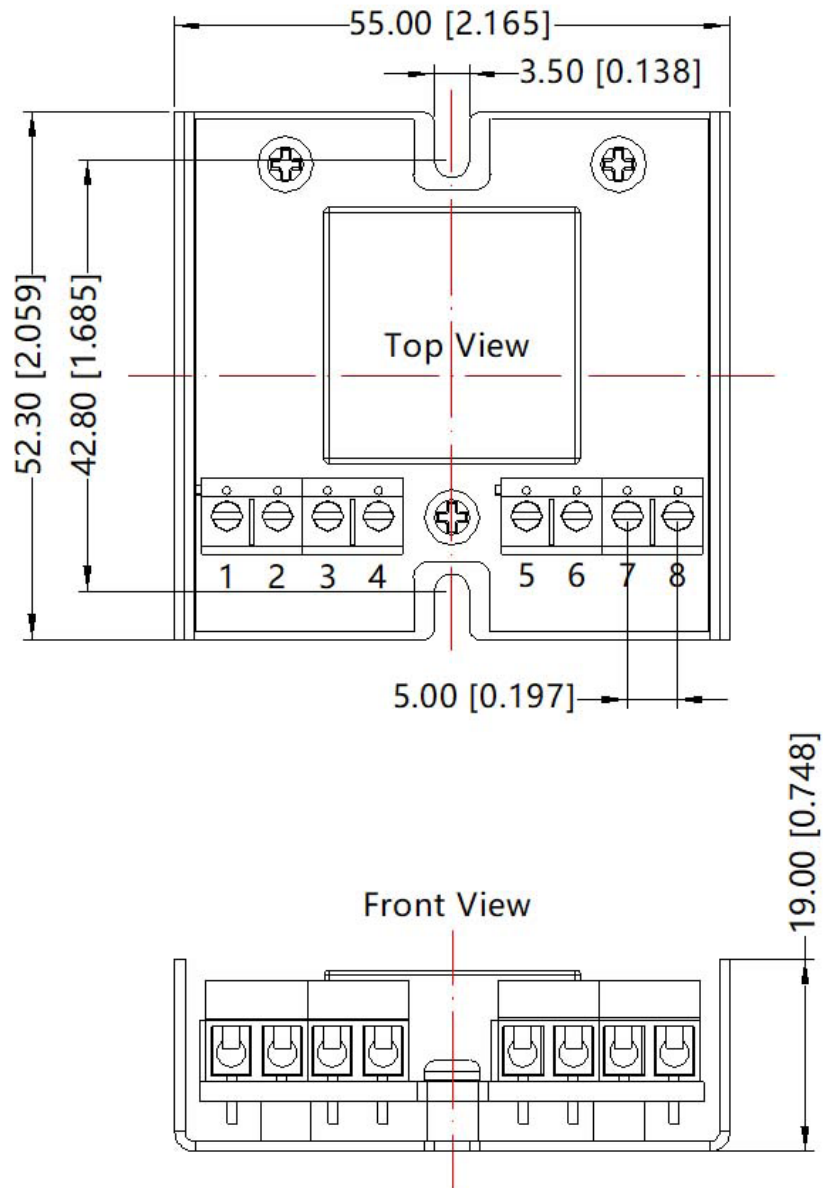

EFFICIENCY CURVES

EFFICIENCY VS INPUT VOLTAGE
PDQE20-Q24-D5-U
(full load)

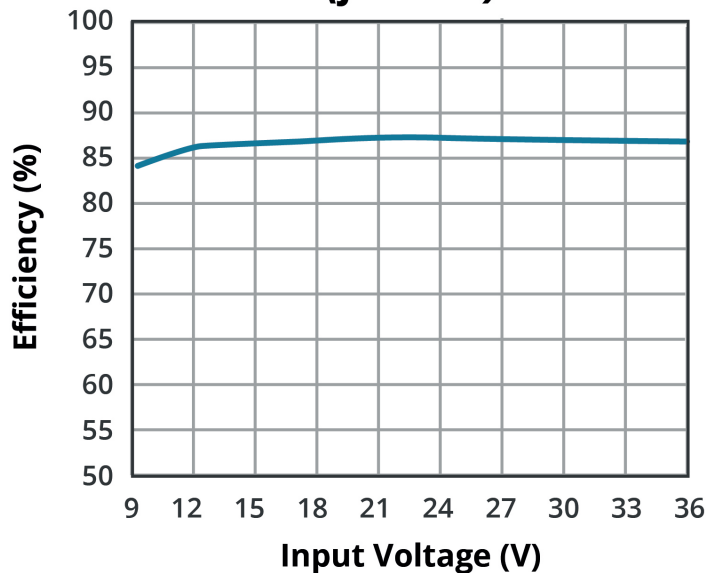

EFFICIENCY VS OUTPUT LOAD
PDQE20-Q24-D5-U
(Vin = 24V)

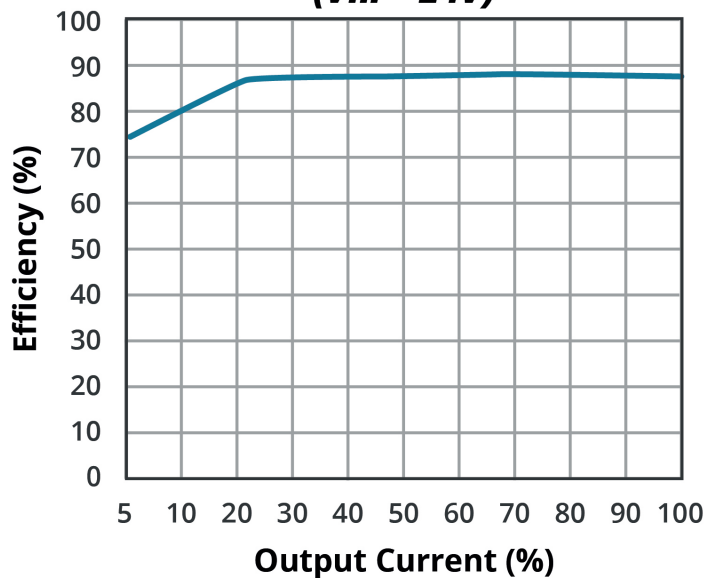

EFFICIENCY VS INPUT VOLTAGE
PDQE20-Q48-D24-U
(full load)

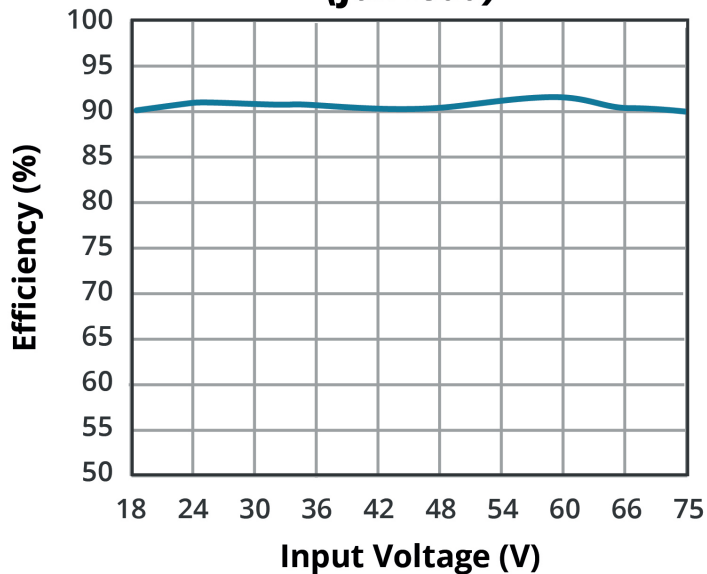

EFFICIENCY VS OUTPUT LOAD
PDQE20-Q48-D24-U
(Vin = 48V)

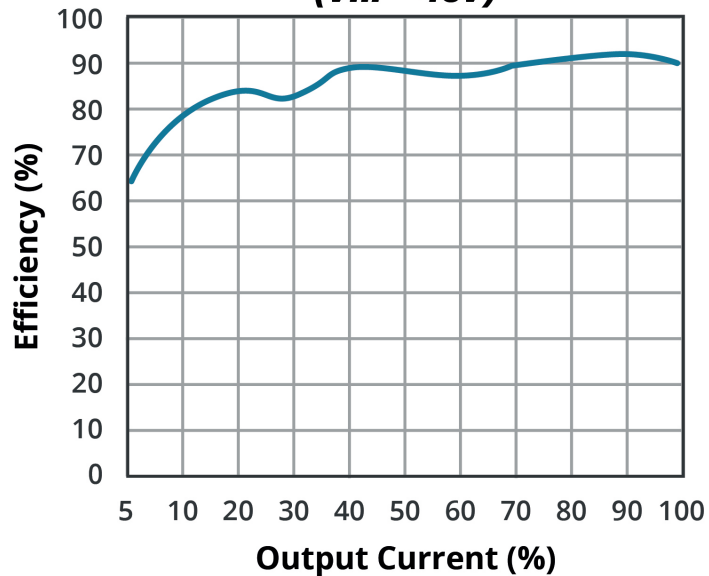

EFFICIENCY CURVES (CONTINUED)

**EFFICIENCY VS INPUT VOLTAGE
PDQE20-Q24-S5-U
(full load)**

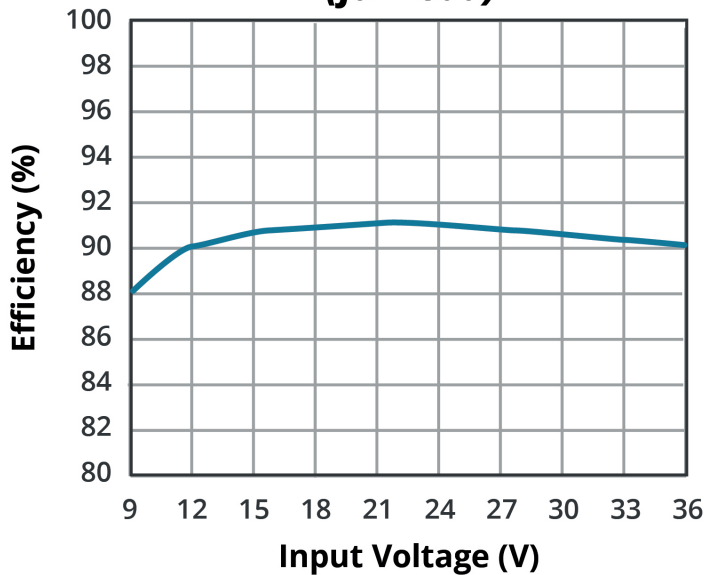

**EFFICIENCY VS OUTPUT LOAD
PDQE20-Q24-S5-U
(Vin = 24V)**

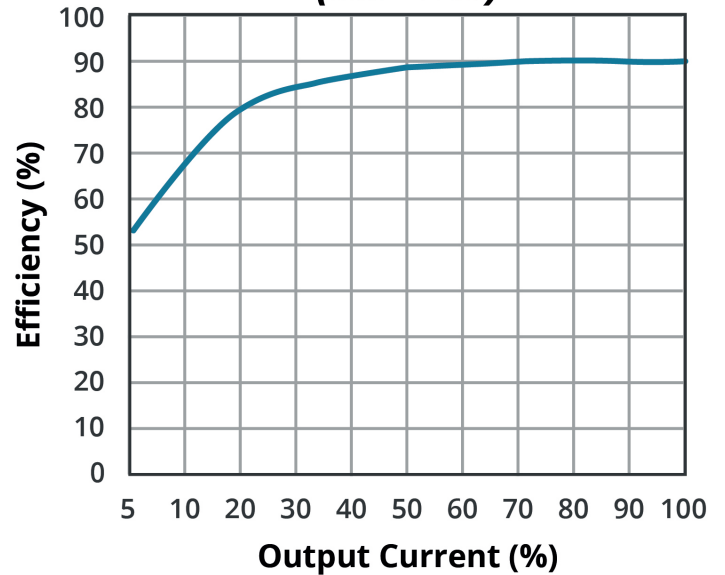

**EFFICIENCY VS INPUT VOLTAGE
PDQE20-Q48-S5-U
(full load)**

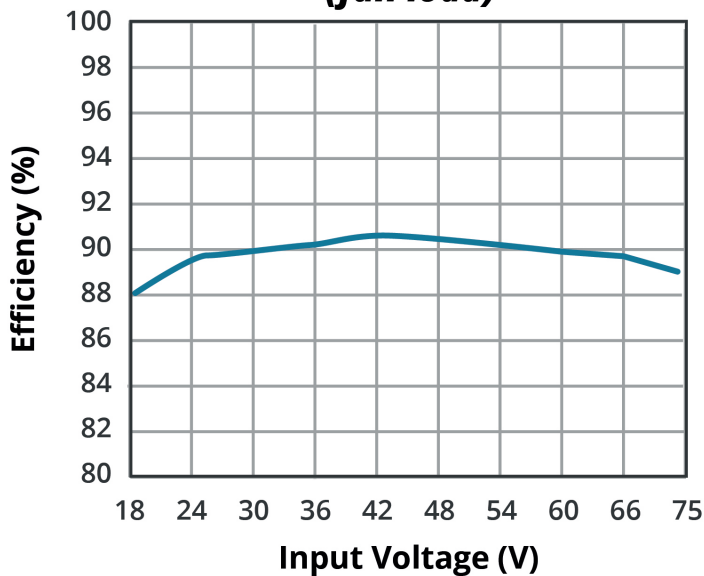

**EFFICIENCY VS OUTPUT LOAD
PDQE20-Q48-S5-U
(Vin = 48V)**

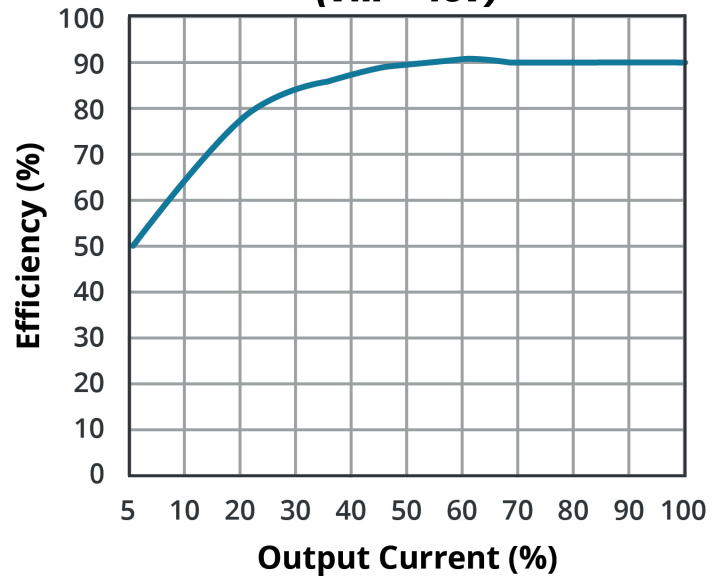

APPLICATION CIRCUIT

This series has been tested according to the following recommended circuits (Figures 1 & 2) before leaving the factory. If you want to further reduce the input and output ripple, you can increase the input and output capacitors or select capacitors of low equivalent series resistance (ESR) provided that the capacitance is less than the maximum capacitive load of the model.

Figure 1
Single Output Models

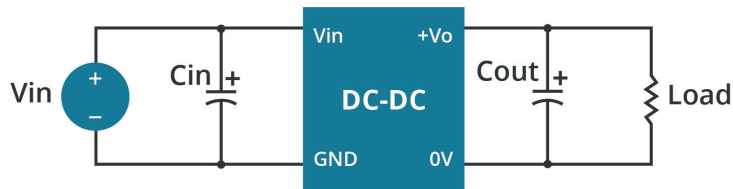

Figure 2
Dual Output Models

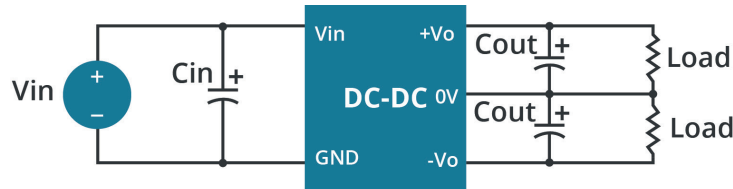

Table 1

| Vin (Vdc) | Cin (μF/V) | Vout (Vdc) | Cout (μF/V) |
|-----------|------------|------------|-------------|
| 24 | 100/50 | ±5 | 10/16 |
| | | ±12/±15 | 10/25 |
| | | ±24 | 10/50 |
| | | 3.3/5/6 | 100/16 |
| | | 12/15 | 100/25 |
| | | 24 | 47/50 |
| 48 | 10~47/50 | ±5 | 10/16 |
| | | ±12/±15 | 10/25 |
| | | ±24 | 10/50 |
| | 100/100 | 3.3/5 | 100/16 |
| | | 12/15 | 100/25 |
| | | 24 | 47/50 |

EMC RECOMMENDED CIRCUIT

Figure 3

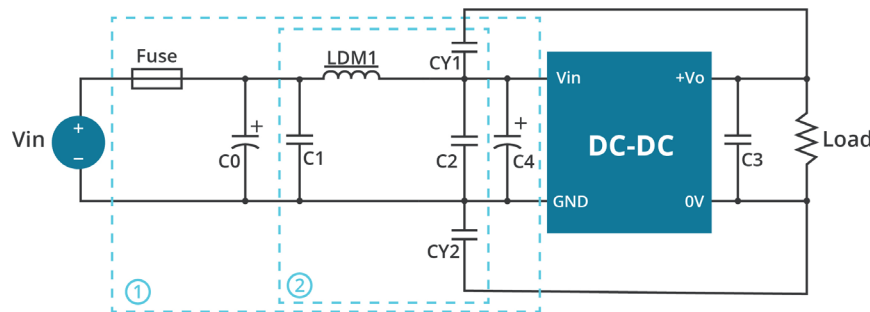

Table 2

| Recommended External Circuit Components | | | |
|---|--|--------------|----------|
| Vin (Vdc) | 24 | | 48 |
| FUSE | choose according to actual input current | | |
| C0/C4 | 330μF / 50V | 330μF / 100V | |
| C1/C2 | 4.7μF / 50V | 4.7μF / 100V | |
| C3 | refer to the Cout in Figure 1 & 2 | | |
| LDM1 | single | 2.2uH/4A | 202uH/2A |
| | dual | 4.7μH | |
| CY1, CY2 | 1nF / 2kV | | |

TRIM FUNCTION

Figure 4

Trim Function for Output Voltage Adjustment (open if unused)

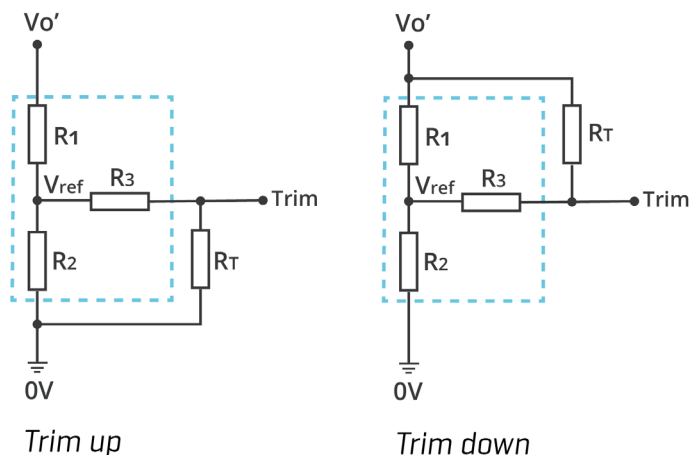

Calculating Trim Resistor Values:

$$RT = \frac{a R2}{R2 - a} - R3$$

$$a = \frac{Vref}{Vo' - Vref} \cdot R1$$

$$RT = \frac{a R1}{R1 - a} - R3$$

$$a = \frac{Vo' - Vref}{Vref} \cdot R2$$

Note:
 RT = Trim Resistance
 a = Self-defined parameter with no real meaning
 Vo' = desired output voltage

Table 3

| Vout (V) | R1 (kΩ) | R2 (kΩ) | R3 (kΩ) | Vref (V) |
|----------|---------|---------|---------|----------|
| 3.3 | 4.829 | 2.87 | 15 | 1.24 |
| 5 | 2.894 | | 10 | 2.5 |
| 6 | 4.064 | | 17.4 | |
| 12 | 11.000 | | 20 | |
| 15 | 14.494 | | | |
| 24 | 24.872 | | | |

REVISION HISTORY

| rev. | description | date |
|------|-----------------|------------|
| 1.0 | initial release | 12/06/2021 |

The revision history provided is for informational purposes only and is believed to be accurate.



CUI INC
a bel group

Headquarters
20050 SW 112th Ave.
Tualatin, OR 97062
800.275.4899

Fax 503.612.2383
cui.com
techsupport@cui.com

CUI offers a two (2) year limited warranty. Complete warranty information is listed on our website.

CUI reserves the right to make changes to the product at any time without notice. Information provided by CUI is believed to be accurate and reliable. However, no responsibility is assumed by CUI for its use, nor for any infringements of patents or other rights of third parties which may result from its use.

CUI products are not authorized or warranted for use as critical components in equipment that requires an extremely high level of reliability. A critical component is any component of a life support device or system whose failure to perform can be reasonably expected to cause the failure of the life support device or system, or to affect its safety or effectiveness.

X-ON Electronics

Largest Supplier of Electrical and Electronic Components

Click to view similar products for [Isolated DC/DC Converters - Rack Mount](#) category:

Click to view products by [CUI Inc](#) manufacturer:

Other Similar products are found below :

[PDQE10-Q48-S5-U](#) [PDQE10-Q24-D15-U](#) [PDQE10-Q48-D12-U](#) [PDQE10-Q48-S12-U](#) [PDQE10-Q48-S15-U](#) [PDQE10-Q24-S12-U](#) [PDQE10-Q24-S15-U](#) [PDQE10-Q24-D12-U](#) [PDQE10-Q48-S3-U](#) [PDQE10-Q48-D15-U](#) [PDQE10-Q48-D5-U](#) [PDQE10-Q24-D5-U](#) [PDQE10-Q24-S24-U](#) [PDQE10-Q48-S24-U](#) [PDQE10-Q24-S3-U](#) [PDQE15-Q24-S5-U](#) [PDQE15-Q24-S12-U](#) [PDQE15-Q48-D12-U](#) [PDQE15-Q48-S5-U](#) [PDQE15-Q24-S15-U](#) [PDQE15-Q24-D12-U](#) [PDQE15-Q24-D15-U](#) [PDQE15-Q24-D5-U](#) [PDQE15-Q48-D15-U](#) [PDQE15-Q48-S3-U](#) [PDQE15-Q48-D5-U](#) [PDQE20-Q48-S12-U](#) [PDQE20-Q24-D15-U](#) [PDQE20-Q48-S5-U](#) [PDQE20-Q24-S24-U](#) [PDQE20-Q24-D12-U](#) [PDQE20-Q48-D15-U](#) [PDQE20-Q48-S15-U](#) [PDQE20-Q48-S3-U](#) [PDQE20-Q24-S15-U](#) [PDQE20-Q48-D5-U](#) [PDQE20-Q24-S3-U](#) [PDQE20-Q24-D5-U](#) [PDQE20-Q48-S24-U](#) [PDQE20-Q24-S5-U](#) [PDQE20-Q48-D12-U](#) [PQAE50-D24-S15-U](#) [PQAE50-D48-S24-U](#) [PQAE50-D24-S5-U](#) [PQAE50-D24-S24-U](#) [PQAE50-D48-S15-U](#) [PQAE50-D48-S5-U](#) [PQAE50-D48-S3-U](#) [PQAE50-D24-S12-U](#) [PQAE50-D24-S3-U](#)