

SERIES: PRQ3W-S | DESCRIPTION: DC-DC CONVERTER
FEATURES

- ultra-wide 4:1 input range
- dual positive output with asymmetrical options
- 3000 Vdc isolation
- input under-voltage protection
- output short circuit and over current protection
- wide operating temp: -40°C to +85°C
- EN62368 approved

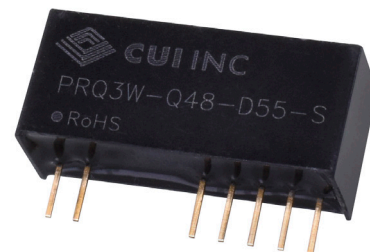

| MODEL | input voltage range (Vdc) | output voltage Vo1/Vo2 (Vdc) | output current max Vo1/Vo2 (A) | output power max (W) | ripple and noise ¹ max Vo1/Vo2 (mVp-p) | efficiency ² | |
|------------------|------------------------------|------------------------------------|--------------------------------------|-------------------------|--|-------------------------|---------|
| | | | | | | min (%) | typ (%) |
| PRQ3W-Q48-D55-S | 18~75 | 5/5 | 300/300 | 3 | 150/150 | 76 | 78 |
| PRQ3W-Q48-D512-S | 18~75 | 5/12 | 300/125 | 3 | 150/150 | 76 | 78 |
| PRQ3W-Q48-D524-S | 18~75 | 5/24 | 300/63 | 3 | 150/150 | 76 | 78 |

Notes: 1. 20MHz bandwidth, nominal input, full load
 2. Efficiency is measured In nominal input voltage and rated output load.

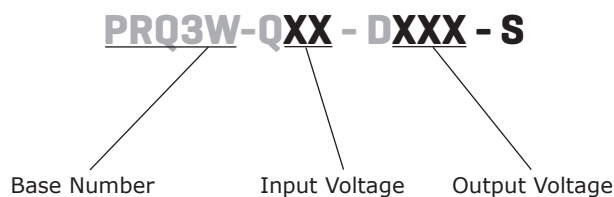
PART NUMBER KEY

INPUT

| parameter | conditions/description | min | typ | max | units |
|---------------|------------------------|-----|-----|-------|-------|
| input voltage | | 18 | 48 | 80 | Vdc |
| filter | capacitance filter | | | | |
| current | full load/no load | | | 83/12 | mA |

OUTPUT

| parameter | conditions/description | min | typ | max | units |
|-------------------------|--|-----|------------------------|------------------------|-------------------|
| output capacitance | 5V outputs | | | 680 | μ F |
| | 12V outputs | | | 330 | μ F |
| | 24V outputs | | | 220 | μ F |
| line regulation | low line to high line | | | | |
| | Vo1 Vo2 | | ± 0.2 ± 0.5 | ± 0.5 ± 1.0 | % |
| load regulation | 10~100% load | | | | |
| | Vo1 Vo2 | | ± 0.5 ± 1.1 | ± 1.0 ± 2.0 | % |
| set-point accuracy | Vo1 / Vo2 | | | | |
| | 10~100% load | | $\pm 1/ \pm 3$ | $\pm 3/ \pm 5$ | % |
| | 5~10% load | | $\pm 2/ \pm 4$ | $\pm 4/ \pm 6$ | % |
| start-up time | nominal input and constant resistance load | | 10 | | ms |
| switching frequency | | | 300 | | kHz |
| transient response | | | | ± 8 500 | % Vout μ s |
| temperature coefficient | full load | | | ± 0.03 | %/°C |

PROTECTIONS

| parameter | conditions/description | min | typ | max | units |
|--------------------------|--------------------------------|-----|-----|-----|-------|
| over current protection | | 110 | | 250 | %Io |
| short circuit protection | output shutdown, auto recovery | | | | |

SAFETY AND COMPLIANCE

| parameter | conditions/description | min | typ | max | units |
|-----------------------|--|------|------|-----|--------|
| isolation voltage | input to output | 3000 | | | Vdc |
| | output to output | 1500 | | | Vdc |
| isolation resistance | input-output resistance at 500 Vdc | 1000 | | | MΩ |
| isolation capacitance | input-output capacitance at 100 KHz/0.1 V | | 1000 | | pF |
| safety approvals | EN/IEC 62368 | | | | |
| EMI/EMC | EN 55032: 2015 Class B (see recommended circuit) | | | | |
| ESD | IEC/EN61000-4-2, Contact ±4KV, perf. Criteria B | | | | |
| radiated immunity | IEC/EN61000-4-3, 10 v/m, perf. Criteria A | | | | |
| EFT/burst | IEC/EN61000-4-4, ±2KV (see recommended circuit), perf. Criteria B | | | | |
| surge | IEC/EN61000-4-5, line to line ±2KV (see recommended circuit), perf. Criteria B | | | | |
| conducted immunity | IEC/EN61000-4-6, 3 Vr.m.s, perf. Criteria A | | | | |
| RoHS | yes | | | | |
| MTBF | MIL-HDBK-217@25°C | 1000 | | | kHours |

ENVIRONMENTAL

| parameter | conditions/description | min | typ | max | units |
|-----------------------|--|-----|-----|-----|-------|
| operating temperature | | -40 | | 85 | °C |
| storage temperature | | -55 | | 125 | °C |
| humidity | non-condensing | 5 | | 95 | % |
| shock/vibration | 10-150Hz, 5G, 0.75mm. along X, Y and Z | | | | |

MECHANICAL

| parameter | conditions/description | min | typ | max | units |
|---------------|---|-----|-----|-----|-------|
| dimensions | 27.40 x 9.50 x 12.00 | | | | mm |
| case material | Black flame-retardant and heat-resistant plastic (UL94 V-0) | | | | |
| weight | | | 5.4 | | g |

MECHANICAL DRAWING

units: mm [inches]
 tolerance: ± 0.50 [±0.020]

| PIN CONNECTIONS | |
|-----------------|----------|
| PIN | FUNCTION |
| 1 | GND |
| 2 | Vin |
| 6 | +Vo1 |
| 7 | -Vo1 |
| 8 | CS* |
| 9 | -Vo2 |
| 10 | +Vo2 |

* Connecting a low ESR capacitor between CS & pin 7 may reduce output ripple & noise. Maximum value = 47 µF

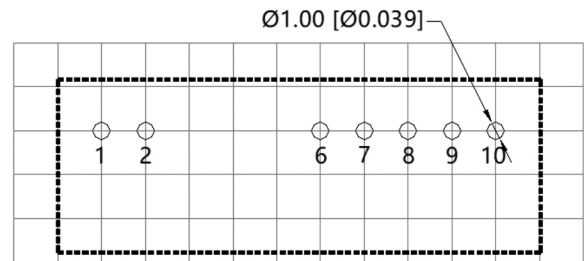
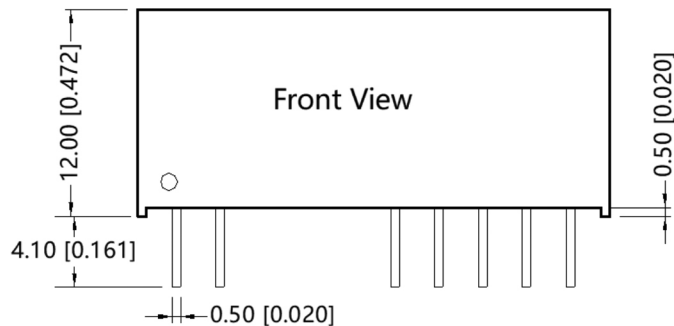

Note : Grid 2.54*2.54mm

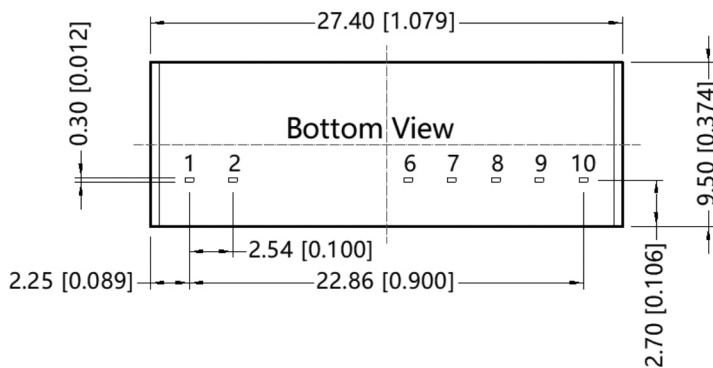

DERATING CURVES

Figure 1

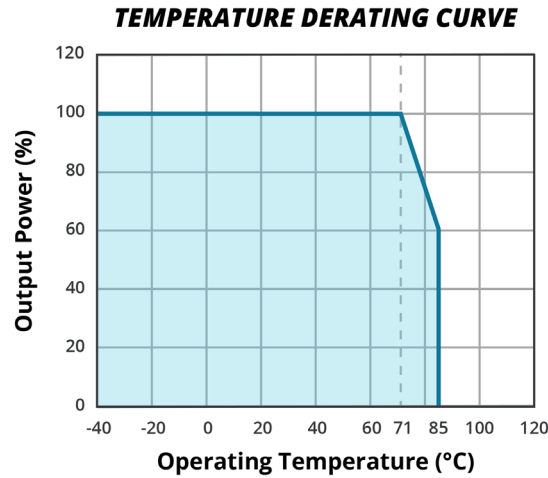

APPLICATION CIRCUIT

All the dc-dc converters of this series are tested before delivery using the recommended circuit shown in Fig. 2.

Input and/or output ripple can be further reduced by appropriately increasing the input & output capacitor values C_{in} and C_{out} and/or by selecting capacitors with a low ESR (equivalent series resistance). Also make sure that the capacitance is not exceeding the max. capacitive load value of the product.

Figure 2

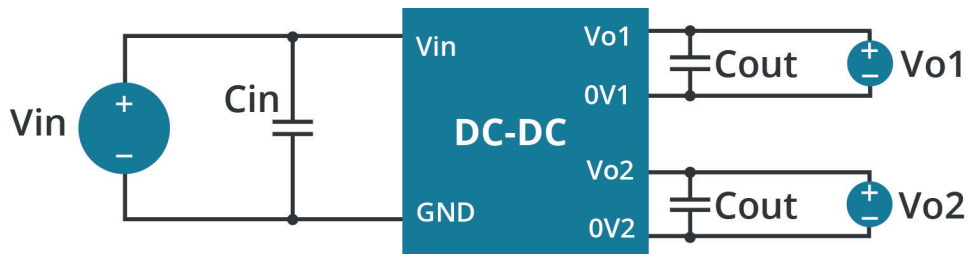

Table 1

| output voltage (Vdc) | C_{in} (uF) | C_{out} (uF) |
|----------------------|---------------|----------------|
| 5 | 47 | 100 |
| 12 | 22 | |
| 24 | 22 | |

EMC RECOMMENDED CIRCUITS

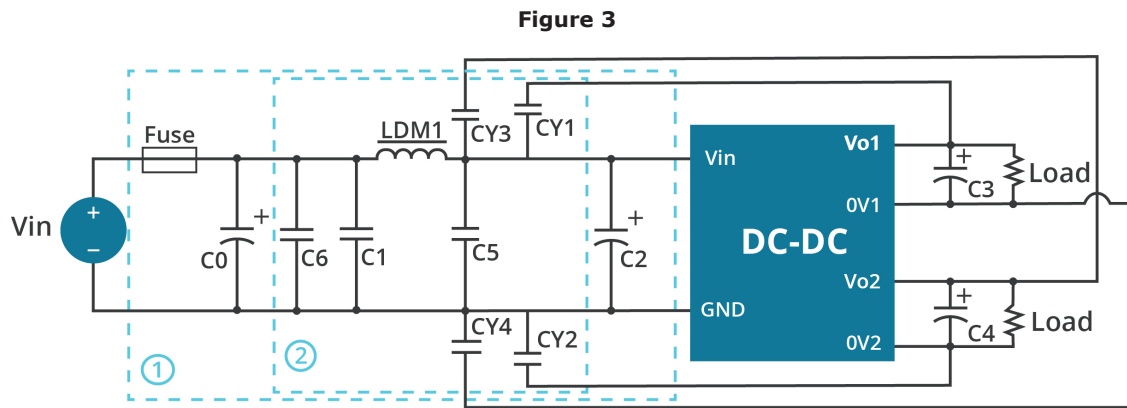

Table 2

| List of Components | |
|--------------------|--|
| Model | Vin:48V |
| FUSE | Choose according to actual input current |
| C0 | 680 μ F/100V |
| C1/C5/C6 | 4.7 μ F/100V |
| C2 | 330 μ F/100V |
| C3/C4 | Refer to the Cout in Fig.2 |
| LDM1 | 22 μ H/0.6A |
| CY1/CY2/CY4 | 1nF/3kV |
| CY3 | 2.2nF/3kV |

REVISION HISTORY

| rev. | description | date |
|------|--|------------|
| 1.0 | initial release | 05/26/2020 |
| 1.01 | derating curve and circuit figures updated | 07/15/2021 |

The revision history provided is for informational purposes only and is believed to be accurate.



Headquarters
20050 SW 112th Ave.
Tualatin, OR 97062
800.275.4899

Fax 503.612.2383
cui.com
techsupport@cui.com

CUI offers a two (2) year limited warranty. Complete warranty information is listed on our website.

CUI reserves the right to make changes to the product at any time without notice. Information provided by CUI is believed to be accurate and reliable. However, no responsibility is assumed by CUI for its use, nor for any infringements of patents or other rights of third parties which may result from its use.

CUI products are not authorized or warranted for use as critical components in equipment that requires an extremely high level of reliability. A critical component is any component of a life support device or system whose failure to perform can be reasonably expected to cause the failure of the life support device or system, or to affect its safety or effectiveness.

X-ON Electronics

Largest Supplier of Electrical and Electronic Components

Click to view similar products for [Isolated DC/DC Converters](#) category:

Click to view products by [CUI Inc](#) manufacturer:

Other Similar products are found below :

[ESM6D044440C05AAQ](#) [FMD15.24G](#) [PSL486-7LR](#) [Q48T30020-NBB0](#) [JAHW100Y1](#) [SPB05C-12](#) [SQ24S15033-PS0S](#) [18952](#) [19-130041](#)
[CE-1003](#) [CE-1004](#) [GQ2541-7R](#) [RDS180245](#) [MAU228](#) [J80-0041NL](#) [DFC15U48D15](#) [XGS-0512](#) [XGS-1205](#) [XGS-1212](#) [XGS-2412](#) [XGS-](#)
[2415](#) [XKS-1215](#) [06322](#) [NCT1000N040R050B](#) [SPB05B-15](#) [SPB05C-15](#) [L-DA20](#) [DCG40-5G](#) [QME48T40033-PGB0](#) [XKS-2415](#) [XKS-2412](#)
[XKS-1212](#) [XKS-1205](#) [XKS-0515](#) [XKS-0505](#) [XGS-2405](#) [XGS-1215](#) [XGS-0515](#) [PS9Z-6RM4](#) [73-551-5038I](#) [AK1601-9RT](#) [VI-N61-CM](#) [VI-](#)
[R5022-EXWW](#) [PSC128-7iR](#) [RPS8-350ATX-XE](#) [DAS1004812](#) [PQA30-D24-S24-DH](#) [VI-M5F-CQ](#) [VI-LN2-EW](#) [VI-PJW01-CZY](#)