

SERIES: PYBE30-U | DESCRIPTION: DC-DC CONVERTER
FEATURES

- up to 30 W isolated output
- 1,500 Vdc isolation
- ultra-wide 4:1 input range (9~36 Vdc, 18~75 Vdc)
- same side input/output connections
- single/dual regulated outputs
- input under-voltage, output short-circuit, over-current, & over-voltage protections
- wide operating temperature range (-40~80°C)
- efficiency up to 90%
- certified to EN 62368-1

MODEL

MODEL	input voltage		output voltage (Vdc)	output current		output power max (W)	ripple & noise ¹ max (mVp-p)	efficiency ² typ (%)
	typ (Vdc)	range (Vdc)		min (mA)	max (mA)			
PYBE30-Q24-D5-U	24	9~36	±5	0	±3,000	30.0	150	86
PYBE30-Q24-D12-U	24	9~36	±12	0	±1,250	30.0	150	89
PYBE30-Q24-D15-U	24	9~36	±15	0	±1,000	30.0	150	89
PYBE30-Q24-D24-U	24	9~36	±24	0	±625	30.0	150	89
PYBE30-Q24-S3-U	24	9~36	3.3	0	6,000	19.8	100	85
PYBE30-Q24-S5-U	24	9~36	5	0	6,000	30.0	100	86
PYBE30-Q24-S9-U	24	9~36	9	0	3,333	30.0	100	88
PYBE30-Q24-S12-U	24	9~36	12	0	2,500	30.0	100	90
PYBE30-Q24-S15-U	24	9~36	15	0	2,000	30.0	100	90
PYBE30-Q24-S24-U	24	9~36	24	0	1,250	30.0	100	90
PYBE30-Q48-D5-U	48	18~75	±5	0	±3,000	30.0	150	86
PYBE30-Q48-D12-U	48	18~75	±12	0	±1,250	30.0	150	88
PYBE30-Q48-D15-U	48	18~75	±15	0	±1000	30.0	150	88
PYBE30-Q48-S3-U	48	18~75	3.3	0	6,000	19.8	100	85
PYBE30-Q48-S5-U	48	18~75	5	0	6,000	30.0	100	87
PYBE30-Q48-S12-U	48	18~75	12	0	2,500	30.0	100	88
PYBE30-Q48-S15-U	48	18~75	15	0	2,000	30.0	100	89
PYBE30-Q48-S24-U	48	18~75	24	0	1,250	30.0	100	87

- Notes:
1. Measured with 20 MHz bandwidth oscilloscope using "parallel cable" method.
 2. Measured at nominal input voltage, full load.
 3. All specifications are measured at Ta=25°C, humidity < 75%, nominal input voltage, and rated output load unless otherwise specified.

PART NUMBER KEY

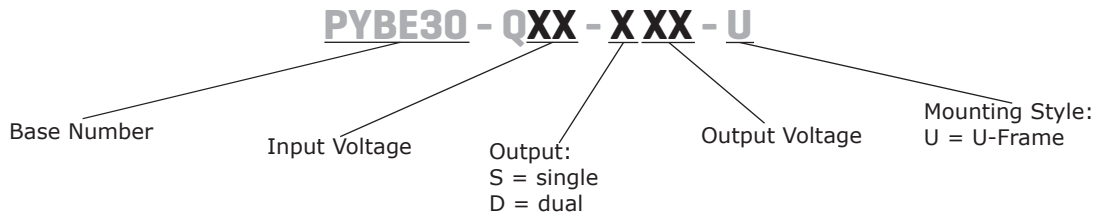

INPUT

parameter	conditions/description	min	typ	max	units
operating input voltage	24 Vdc input models	9	24	36	Vdc
	48 Vdc input models	18	48	75	Vdc
start-up voltage	24 Vdc input models			9	Vdc
	48 Vdc input models			18	Vdc
surge voltage	for maximum of 1 second				
	24 Vdc input models	-0.7		50	Vdc
	48 Vdc input models	-0.7		100	Vdc
under voltage shutdown	24 Vdc input models	5.5	6.5		Vdc
	48 Vdc input models	12.0	15.5		Vdc
current (full load / no load)	24 Vdc input models	3.3 Vdc output models	971/60	994/100	mA
		5 Vdc output models	1454/60	1488/100	mA
	all other models	1420/6	1488/16	mA	
48 Vdc input models	3.3 Vdc output models	480/20	491/30	mA	
	5 Vdc output models	718/20	735/35	mA	
	all other models	702/5	744/10	mA	
remote on/off (CTRL) ⁴	turn on (pin open or pulled high, 3.5~12 Vdc or open circuit) turn off (pin pulled low to GND, <1.2 Vdc) input current when switched off		5	8	mA
filter	Pi filter				
no load power consumption			0.14		W

Notes: 4. The voltage of the CTRL pin is referenced to input GND pin.

OUTPUT

parameter	conditions/description	min	typ	max	units
maximum capacitive load ⁵	3.3, 5 Vdc output models			10,000	μF
	9 Vdc output models			4,700	μF
	12 Vdc output models			2,700	μF
	15 Vdc output models			1,680	μF
	±5 Vdc output models			2,000	μF
	±12 Vdc output models			1,250	μF
	24, ±15 Vdc output models			680	μF
voltage accuracy	5% to 100% load		±1	±3	%
	0% to 5% load		±1	±5	%
line regulation	from low line to high line, 100% load				
	positive outputs		±0.2	±0.5	%
	negative outputs		±0.5	±1	%
load regulation ⁶	from 5% to full load				
	positive outputs		±0.5	±1	%
	negative outputs		±0.5	±1.5	%

Note: 5. The specified maximum capacitive load value for positive and negative output is identical

6. At 0~100% load, the max load regulation is ±5%.

OUTPUT (CONTINUED)

parameter	conditions/description	min	typ	max	units
cross regulation	dual output models: main output 50% load secondary output from 10 to 100% load			±5	%
start-up time	nominal input, constant resistive load		10		ms
switching frequency ⁷	PWM mode		300		kHz
transient recovery time	25% load step change, nominal input voltage		300	500	µs
transient response deviation	25% load step change, nominal input voltage 3.3, 5, ±5 Vdc output models all other models		±5 ±3	±8 ±5	% %
temperature coefficient	at full load			±0.03	%/°C
trim	single output models only		±10		%

Note: 7. Value is based on full load. The switching frequency is reduced for light load (<50%) efficiency improvement

PROTECTIONS

parameter	conditions/description	min	typ	max	units
over voltage protection		110		160	%
over current protection		110		190	%
short circuit protection	hiccup, continuous, auto recovery				

SAFETY AND COMPLIANCE

parameter	conditions/description	min	typ	max	units
isolation voltage	input to output for 1 minute, 1 mA max	1,500			Vdc
isolation resistance	input to output for 1 minute at 500 Vdc	1,000			MΩ
isolation capacitance	input to output, 100 kHz / 0.1 V		2,000		pF
safety approvals	certified to 62368-1: EN, IEC				
conducted emissions	CISPR32/EN55032 CLASS A (without external components) CISPR32/EN55032 CLASS B (see recommended circuit Fig. 3-2 and 4-2) EN 50121-3-2 150kHz-500kHz 99BuV EN 55016-2-1 500 kHz-30MHz 93dBuV				
radiated emissions	CISPR32/EN55032 CLASS A (without external components) CISPR32/EN55032 CLASS B (see recommended circuit Fig. 3-2 and 4-2) EN 50121-3-2 30MHz-230MHz 40dBuV/m at 10m EN 55016-2-1 230MHz-1GHz 47dBuV/m at 10m				
ESD	IEC/EN61000-4-2 Contact ±4kV, perf. Criteria B EN50121-3-2 Contact ±6kV/Air ±8kV, perf. Criteria A				
radiated immunity	IEC/EN61000-4-3 10V/m, perf. Criteria A EN50121-3-2 20V/m, perf. Criteria A				
EFT/burst	IEC/EN61000-4-4 ±2kV, perf. Criteria B EB50121-3-2 ±2kV 5/50ns 5kHz, perf. Criteria A				
surge	IEC/EN61000-4-5 line to line ±2kV, perf. Criteria B IEC/EN50121-3-2 line to line ±1kV (42Ω, 0.5µF), perf. Criteria A				
conducted immunity	IEC/EN61000-4-6 3 Vr.m.s (single output), perf. Criteria A IEC/EN61000-4-6 10 Vr.m.s (dual output), perf. Criteria A EN50121-3-2 0.15MHz-80MHz 10Vr.m.s, perf. Criteria A				
MTBF	as per MIL-HDBK-217F, 25°C	1,000,000			hours
RoHS	yes				

ENVIRONMENTAL

parameter	conditions/description	min	typ	max	units
operating temperature	see derating curves	-40		80	°C
storage temperature		-55		125	°C
storage humidity	non-condensing	5		95	%
vibration	IEC/EN61373 - Category 1, Grade B				

DERATING CURVES

**TEMPERATURE DERATING CURVE
(dual output)**

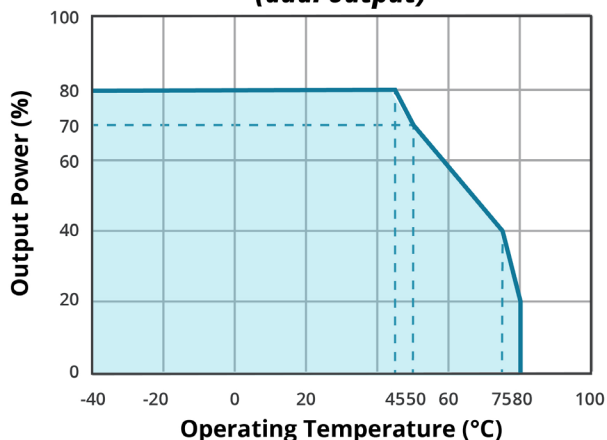

Applicable models (Vin min to Vin max):
 PYBE30-Q24-D5-U (9-18V), PYBE30-Q24-D24-U (9-18V),
 PYBE30-Q48-D5-U (18-36V)

**TEMPERATURE DERATING CURVE
(dual output)**

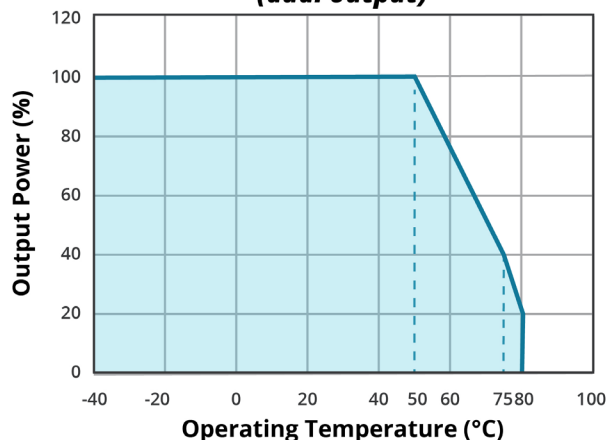

Applicable models (Vin min to Vin max):
 PYBE30-Q24-D5-U (18-36V), PYBE30-Q24-D24-U (18-36V),
 PYBE30-Q48-D5-U (36-75V), PYBE30-Q24-D12-U (9-36V),
 PYBE30-Q24-D15-U (9-36V), PYBE30-Q48-D12-U (18-75V),
 PYBE30-Q48-D15-U (18-75V)

**TEMPERATURE DERATING CURVE
(single output)**

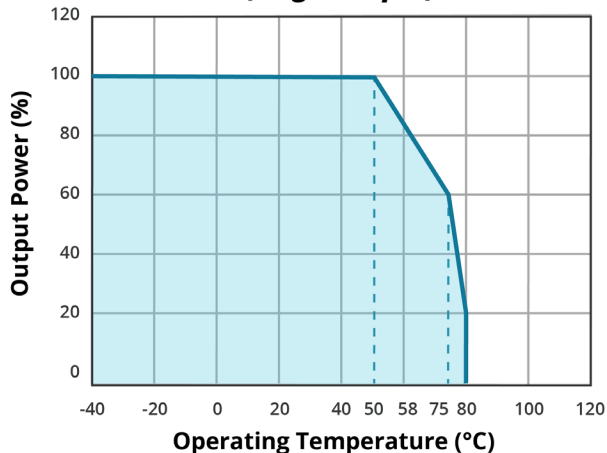

Applicable models (Vin min to Vin max):
 PYBE30-Q24-S3-U (9-36V), PYBE30-Q24-S5-U (9-36V),
 PYBE30-Q48-S3-U (18-75V), PYBE30-Q48-S5-U (18-75V)

**TEMPERATURE DERATING CURVE
(single output)**

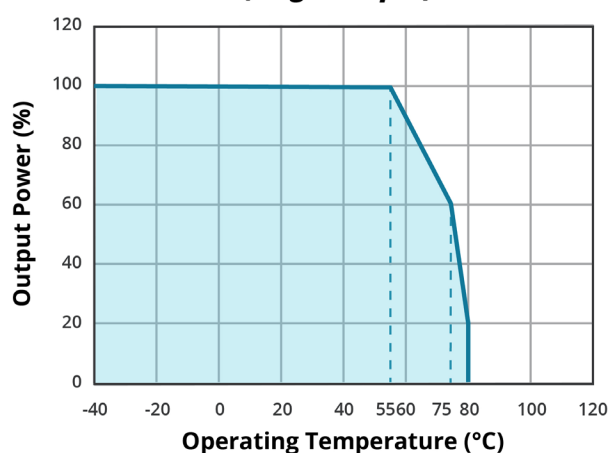

Applicable models (Vin min to Vin max):
 PYBE30-Q24-S9-U (9-36V), PYBE30-Q24-S12-U (9-36V),
 PYBE30-Q24-S15-U (9-36V), PYBE30-Q24-S24-U (9-36V),
 PYBE30-Q48-S12-U (18-75V), PYBE30-Q48-S15-U (18-75V),
 PYBE30-Q48-S24-U (18-75V)

EFFICIENCY CURVES

EFFICIENCY VS INPUT VOLTAGE
(full load)
PYBE30-Q24-S5-U

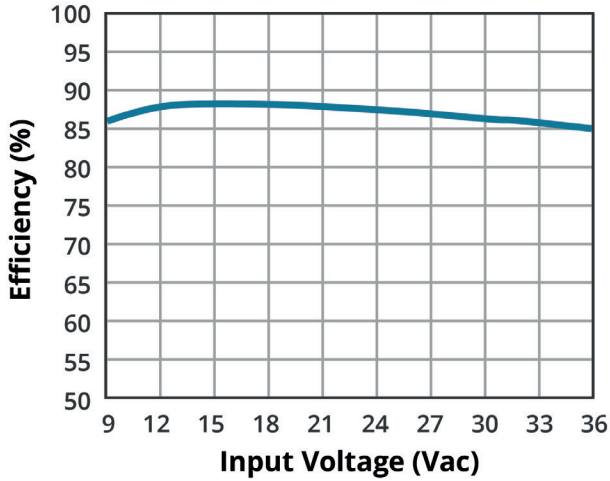

EFFICIENCY VS OUTPUT LOAD
($V_{in} = 24V$)
PYBE30-Q24-S5-U

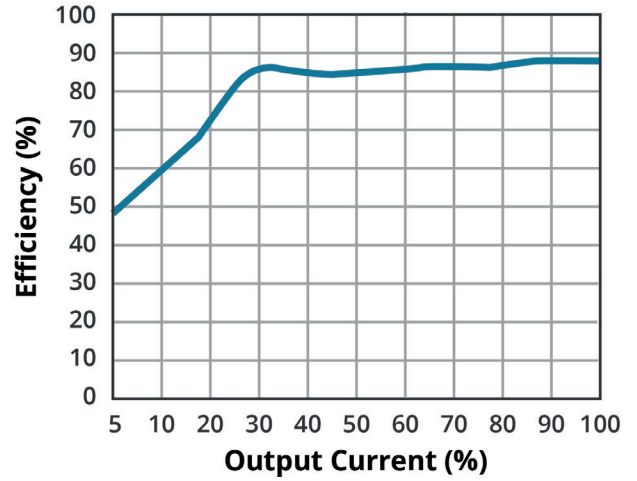

EFFICIENCY VS INPUT VOLTAGE
(full load)
PYBE30-Q48-D15-U

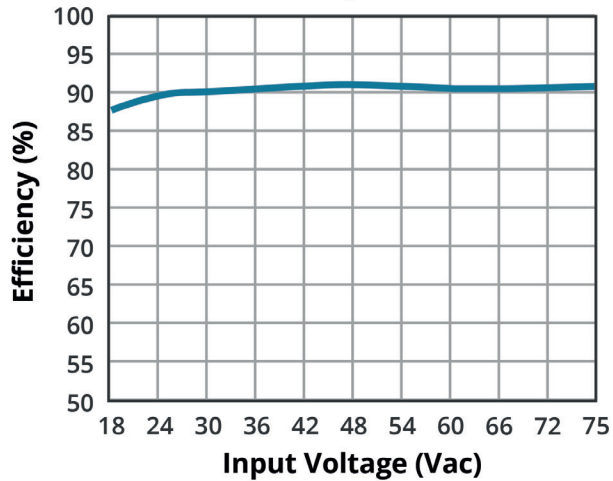

EFFICIENCY VS OUTPUT LOAD
($V_{in} = 48V$)
PYBE30-Q48-D15-U

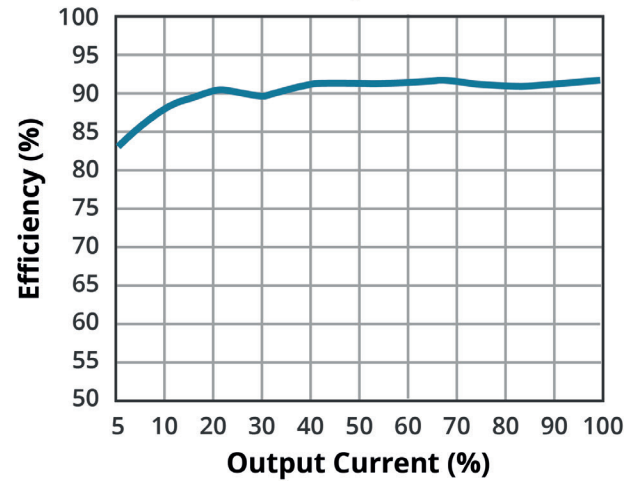

MECHANICAL

parameter	conditions/description	min	typ	max	units
dimensions	55.00 x 52.30 x 19.00 [2.165 x 2.059 x 0.748 inch]				mm
case material	aluminum alloy				
weight			59		g

MECHANICAL DRAWING

units: mm [inch]
 wire range: 24~12 AWG
 tightening torque: Max 0.4 N·m
 tolerance: ±1.00[±0.039]

PIN CONNECTIONS		
PIN	Function	
	Single	Dual
1	GND	GND
2	Vin	Vin
3	CTRL	CTRL
4	Case	Case
5	NC	NC
6	+Vo	+Vo
7	0V	0V
8	Trim	-Vo

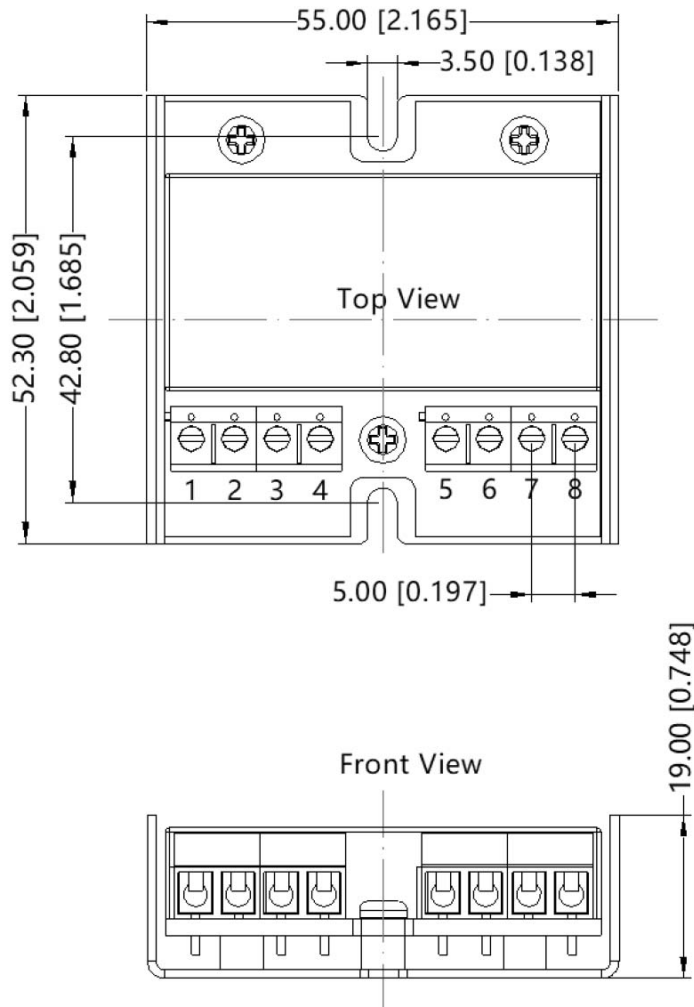

APPLICATION CIRCUIT

This series has been tested according to the following recommended circuits (Figures 1 & 2) before leaving the factory. If you want to further reduce the input and output ripple, you can increase the input and output capacitors or select capacitors of low equivalent impedance provided that the capacitance is less than the maximum capacitive load of the model.

Figure 1
Single Output Models

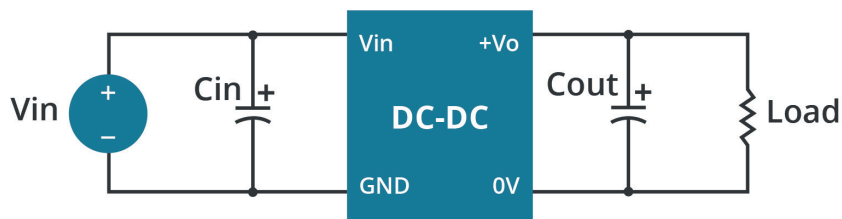

Figure 2
Dual Output Models

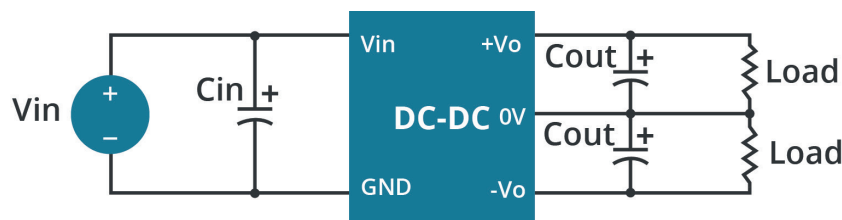

Table 1

Cin (Vdc)		Single Vout (Vdc)	Cout (μF / V)	Dual Vout (Vdc)	Cout (μF / V)
Vin: 24 Vdc	Vin: 48 Vdc	3.3 / 5 / 9	220μF / 16V	±5	220μF / 16V
100μF / 50V	100μF / 100V	12 / 15	100μF / 25V	±12 / ±15	220μF / 25V
		24	100μF / 50V	±24	100μF / 50V

EMC RECOMMENDED CIRCUIT

Figure 3
Single Output Models

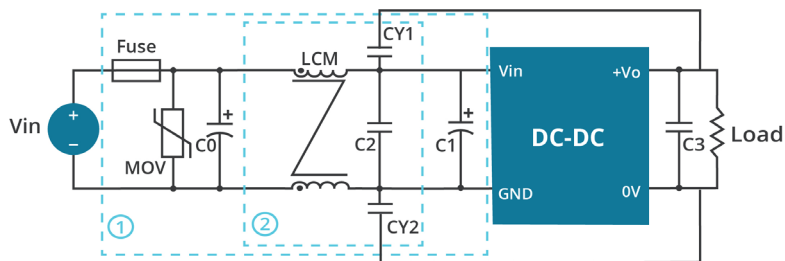

Table 2

Recommended External Circuit Components		
Vin (Vdc)	24	48
FUSE	choose according to actual input current	
MOV	S20K30	S14K60
C0	680 μ F / 50V	330 μ F / 100V
C1	330 μ F / 50V	330 μ F / 100V
C2	4.7 μ F / 50V	2.2 μ F / 100V
C3	Refer to the Cout in Table 1	
LCM	1 mH	
CY1, CY2	1nF / 2kV	

Figure 4
Dual Output Models

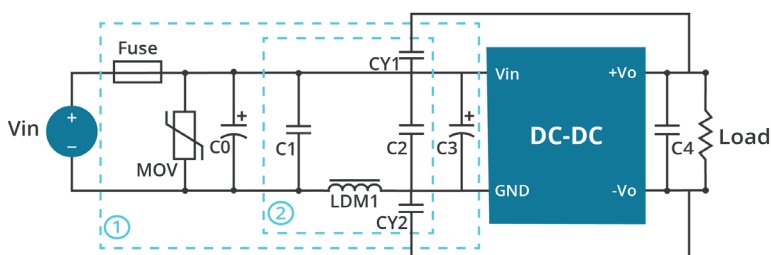

Table 3

Recommended External Circuit Components		
Vin (Vdc)	24	48
FUSE	choose according to actual input current	
MOV	S20K30	S14K60
C0	680 μ F / 50V	330 μ F / 100V
C1	2.2 μ F / 50V	2.2 μ F / 100V
C2	2.2 μ F / 50V	2.2 μ F / 100V
C3	330 μ F / 50V	330 μ F / 100V
C4	Refer to the Cout in Table 1	
LDM1	3.3 μ H	
CY1, CY2	2.2 nF / 4 kV	

APPLICATION NOTES

Figure 5

Application Circuit for Trim pin
(part in broken line is the interior of models)

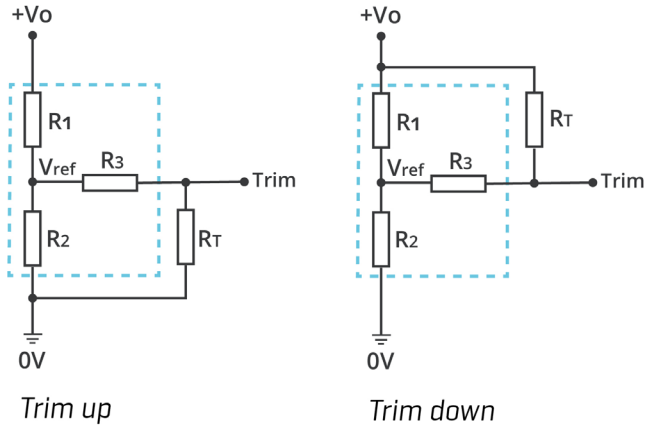

Formula for Trim Resistor

$$\begin{aligned} \text{up: } R_T &= \frac{aR_2}{R_2-a} - R_3 & a &= \frac{V_{ref}}{V_{o'} - V_{ref}} \cdot R_1 \\ \text{down: } R_T &= \frac{aR_1}{R_1-a} - R_3 & a &= \frac{V_{o'} - V_{ref}}{V_{ref}} \cdot R_2 \end{aligned}$$

Note: Value for R1, R2, R3, and Vref refer to Table 4
 R_T : Trim Resistor
 a: User-defined parameter, no actual meanings
 $V_{o'}$: The trim up/down voltage

Table 4

Vout (Vdc)	R1 (kΩ)	R2 (kΩ)	R3 (kΩ)	Vref (V)
3.3	4.801	2.87	12.4	1.24
5	2.883	2.87	10	2.5
9	7.500	2.87	15	2.5
12	11.000	2.87	15	2.5
15	14.494	2.87	15	2.5
24	24.872	2.87	17.8	2.5

REVISION HISTORY

rev.	description	date
1.0	initial release	03/21/2022

The revision history provided is for informational purposes only and is believed to be accurate.



CUI INC

a bel group

Headquarters

20050 SW 112th Ave.
Tualatin, OR 97062
800.275.4899

Fax 503.612.2383
cui.com
techsupport@cui.com

CUI offers a two (2) year limited warranty. Complete warranty information is listed on our website.

CUI reserves the right to make changes to the product at any time without notice. Information provided by CUI is believed to be accurate and reliable. However, no responsibility is assumed by CUI for its use, nor for any infringements of patents or other rights of third parties which may result from its use.

CUI products are not authorized or warranted for use as critical components in equipment that requires an extremely high level of reliability. A critical component is any component of a life support device or system whose failure to perform can be reasonably expected to cause the failure of the life support device or system, or to affect its safety or effectiveness.

X-ON Electronics

Largest Supplier of Electrical and Electronic Components

Click to view similar products for [Isolated DC/DC Converters - Chassis Mount](#) category:

Click to view products by [CUI Inc](#) manufacturer:

Other Similar products are found below :

[EBC4050N042N75](#) [12RCM60-12](#) [RQB-50Y28](#) [RQB-50Y54](#) [RQB-50Y12](#) [RQB-50Y15](#) [RQB-50Y24](#) [CQB75-300S3V3-F](#) [CQB75-300S24-F](#)
[CQB75-300S48-F](#) [CQB75-300S12-F](#) [CQB75-300S05-F](#) [CQB75-300S15-F](#) [CQB75-300S3V3](#) [CQB75W14-72S15](#) [CQB75W14-72S15N](#)
[CQB75W14-72S24](#) [CQB75W14-72S05N](#) [CQB75W14-72S12N](#) [CQB75W14-72S28N](#) [CQB75W14-72S05](#) [CQB75W14-72S12](#) [CQB75W14-72S24N](#)
[CQB75W14-72S54](#) [CQB75W14-72S28](#) [CQB75W14-72S54N](#) [STMGFS80483R3](#) [STMGFS804815](#) [STMGFS80243R3](#)
[STMGFS804812](#) [STMGFS802415](#) [STMGFS804805](#) [AE15B-UW-S24-T](#) [AE15B-EW-S15-T](#) [AE15B-UW-S5-T](#) [AE15B-EW-S24-T](#) [AE15B-UW-S12-T](#)
[AE15B-EW-S12-T](#) [AE15B-UW-S15-T](#) [PYBE30-Q24-S9-U](#) [PYBE30-Q24-D12-U](#) [PYBE30-Q24-S24-U](#) [PYBE30-Q24-S3-U](#)
[PYBE30-Q48-S3-U](#) [PYBE30-Q24-S12-U](#) [PYBE30-Q48-S5-U](#) [PYBE30-Q24-D24-U](#) [PYBE30-Q24-S15-U](#) [PYBE30-Q48-D12-U](#) [PYBE30-Q48-D5-U](#)