

SERIES: VGS-500B | DESCRIPTION: AC-DC POWER SUPPLY
FEATURES

- 500 W continuous output power
- peak power of 600 W for 5 seconds
- certified to UL/EN 62368
- designed to meet EIC/EN 60335-1
- 3" x 5" footprint
- active PFC
- temperature range -40 °C to 85 °C with derating
- operating altitude up to 5000 m
- short-circuit, over-current, over-voltage & over-temperature protection
- 12 V, 0.5 A fan supply
- 5 V, 1 A standby supply
- remote on/off
- remote output voltage sensing
- parallel output operation



MODEL	output voltage	output current ¹	output power	ripple and noise ²	efficiency ³
	typ (Vdc)	max (A)	max (W)	max (mVp-p)	typ (%)
VGS-500B-12	12	41.67	500	120	92.5
VGS-500B-18	18	27.78	500	150	93.5
VGS-500B-24	24	20.83	500	150	94.5
VGS-500B-28	28	17.86	500	200	94.5
VGS-500B-30	30	16.67	500	200	94.5
VGS-500B-36	36	13.89	500	200	94.5
VGS-500B-48	48	10.42	500	250	94.5

Notes:

1. With 21 CFM of forced air cooling
2. At full load, nominal input, 20 MHz bandwidth oscilloscope, output terminated with 10 μ F electrolytic and 0.1 μ F ceramic capacitors.
3. Efficiency is measured at full load, and 230 Vac input.
4. All specifications are typical at nominal input, full load at 25°C unless otherwise noted.

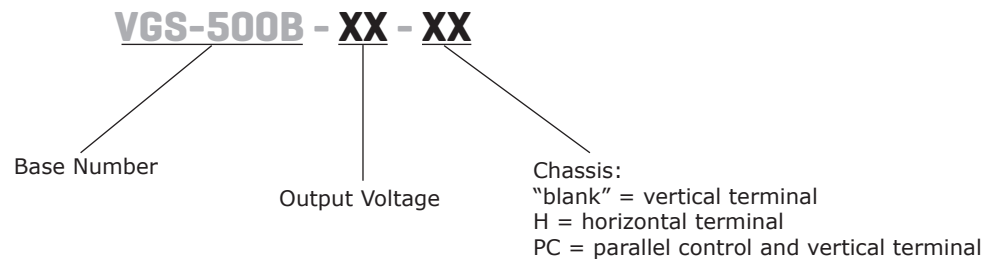
PART NUMBER KEY

INPUT

parameter	conditions/description	min	typ	max	units
voltage		80	100~240	264	Vac
frequency		47	50~60	63	Hz
current	at full load, 100 Vac input			6	A
inrush current	at 240 Vac, cold start at 25 °C		8.5		A
leakage current	earth touch			0.3 0.1	mA mA
power factor correction	at 230 Vac input		0.97		
no load power consumption			0.5		W

OUTPUT

parameter	conditions/description	min	typ	max	units
line regulation	high line to full line			±0.5	%
load regulation	10 % to 100 % load			±1	%
output voltage set point	at 80 Vac ~ 264 Vac input (see derating curve)				
	12 Vdc output model	11.88	12	12.12	Vdc
	18 Vdc output model	17.82	18	18.18	Vdc
	24 Vdc output model	23.76	24	24.24	Vdc
	28 Vdc output model	26.6	28	29.4	Vdc
	30 Vdc output model	28.5	30	31.5	Vdc
	36 Vdc output model	35.64	36	36.36	Vdc
	48 Vdc output model	47.52	48	48.48	Vdc
hold-up time	at 115 Vac, full load		16		ms
adjustability	via Vadj trim pot (see mechanical drawing)			±5	%
peak power ⁵	at 115 Vac & 230 Vac, full load, 25 °C		120		%
current sharing accuracy	50 % to 100 % load		±5		%
PS on signal ⁶	power on	0		2	Vdc
	power off (PS on, GND open)		4		Vdc
	power on (PS on, GND short)		10		mA
	power off (PS on, GND open)		0		mA
PF signal	at 80 Vac to 264 Vac, full load TTL high after power set up	100		500	ms
	at 80 Vac to 264 Vac, full load TTL low before Vo is below 90% of rated value	1	10		ms
switching frequency	at maximum rated power		65		kHz
fan output voltage ⁷	12 Vdc / 0.5 A		12		Vdc
standby	5 Vdc / 1 A (forced air & convection cooling)				

Notes: 5. Peak power should be less than 5 seconds, with a maximum 10 % duty cycle, peak power function by 120% load 5 seconds and 75% load 45 seconds.

6. Absolute maximum rating: 60V.

7. Fan output can only operate normal when the stand-by output is above 0.5A.

PROTECTIONS

parameter	conditions/description	min	typ	max	units
over voltage protection	latching (ac recycle to reset)				
	12 Vdc output model			16	Vdc
	18 Vdc output model			30	Vdc
	24, 28, 30 Vdc output models			35	Vdc
	36 Vdc output model			50	Vdc
	48 Vdc output model			63	Vdc
over current protection	auto recovery	120		190	%
short circuit protection	auto recovery				

over temperature protection auto recovery

SAFETY & COMPLIANCE

parameter	conditions/description	min	typ	max	units
capacitive load	at 115 Vac & 230 Vac, full load, 25 °C				
	12 Vdc output model			42,900	µF
	18 Vdc output model			28,600	µF
	24 Vdc output model			20,800	µF
	28 Vdc output model			18,000	µF
	30 Vdc output model			16,600	µF
	36 Vdc output model			14,000	µF
isolation voltage	48 Vdc output model			10,800	µF
	input to output 1 minute			4,000	Vac
	input to ground 1 minute			1,800	Vac
	output to ground for 1 minute			1,800	Vac
safety approvals	certified to 62368-1: UL, EN				
safety class	class I				
EMI/EMC	EN 55032:2015+AC:2016, EN 61000-6-3 2007+A1: 2011+AC: 2012, Class B EN 61000-6-4:2007+A1:2011, 47 CFR FCC Part 15 Subpart B (Class B) EN 61204-3:2000, EN 61000-3-2:2014, EN 61000-3-3:2013				
conducted emissions	EN 55032:2015+AC:2016, EN 61000-6-3 2007+A1: 2011+AC: 2012, Class B EN 61000-6-4:2007+A1:2011, 47 CFR FCC Part 15 Subpart B (Class B)				
radiated emissions	EN 55032:2015+AC:2016, EN 61000-6-3 2007+A1: 2011+AC: 2012, Class B EN 61000-6-4:2007+A1:2011, 47 CFR FCC Part 15 Subpart B (Class B)				
ESD	IEC 61000-4-2:2008, air discharge: ±8 kV, contact discharge: ±4 kV, perf. Criteria A				
radiated immunity	IEC 61000-4-3:2006+A1:2007+A2:2010, perf. Criteria A				
EFT/burst	IEC 61000-4-4:2012, ±1 kV, ±2 kV, perf. Criteria A				
surge	IEC 61000-4-5:2014+A1:2017, line to neutral: ±0.5 kV, ±1 kV, line to ground: ±0.5 kV, ±1kV, ±2 kV, perf. Criteria A				
conducted immunity	IEC 61000-4-6:2013+COR1:2015, perf. Criteria A				
PFMF	IEC 61000-4-8:2009, perf. Criteria A				
voltage dips	IEC 61000-4-11:2004+A1:2017, dip: 30 % reduction, dip > 95 % reduction, perf. Criteria A				
voltage interruptions	IEC 61000-4-11:2004+A1:2017, > 95 % reduction, perf. Criteria B				
MTBF	as per MIL-HDBK-217F at 25°C		200,000		hours
RoHS	yes				

ENVIRONMENTAL

parameter	conditions/description	min	typ	max	units
operating temperature	see derating curves	-40		85	°C
maximum case temperature	center of the base plate	-40		85	°C
storage temperature		-40		85	°C
operating humidity	non-condensing	0		93	%
shock	MIL-STD-810F table 516.5, table 516.5-I, 10ms, each axis 3 times (±X, ±Y, ±Z axes)		75		g
vibration	MIL-STD-810F table 514.5C-VIII, 15~2000 Hz, X, Y, Z axes, 1 hour (each axis), total 3 hours		4		g
altitude				5,000	m

DERATING CURVES

INPUT VOLTAGE DERATING CURVE
(21 CFM forced air)

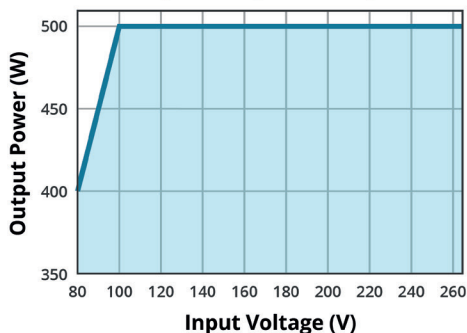

TEMPERATURE DERATING CURVE
(21 CFM forced air)

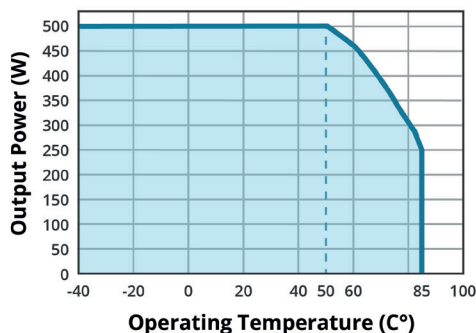

INPUT VOLTAGE DERATING CURVE
(natural convection)

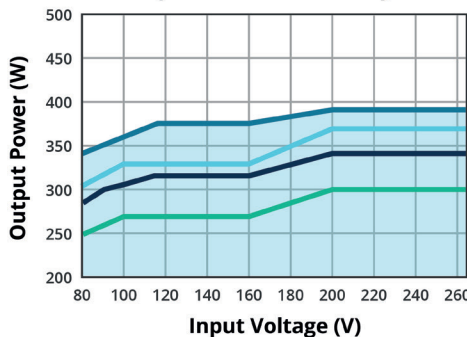

Key

- VGS-500B-12 at 30°C
- VGS-500B-12-H at 30°C
- VGS-500B-12 at 50°C
- VGS-500B-12-H at 50°C

TEMPERATURE DERATING CURVE
(natural convection)

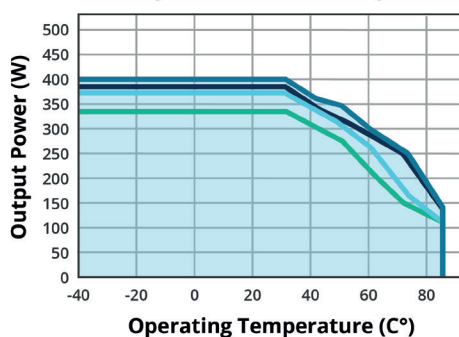

Key

- VGS-500B-12 at 230 Vac
- VGS-500B-12-H at 230 Vac
- VGS-500B-12 at 115 Vac
- VGS-500B-12-H at 115 Vac

INPUT VOLTAGE DERATING CURVE
(natural convection)

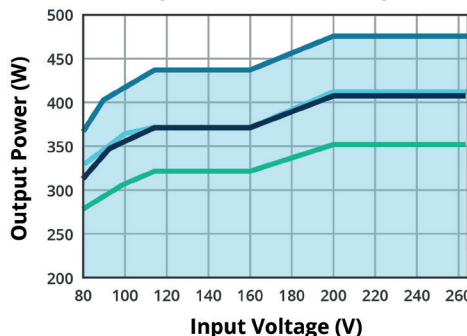

Key

- VGS-500B-18 at 30°C
- VGS-500B-18-H at 30°C
- VGS-500B-18 at 50°C
- VGS-500B-18-H at 50°C

TEMPERATURE DERATING CURVE
(natural convection)

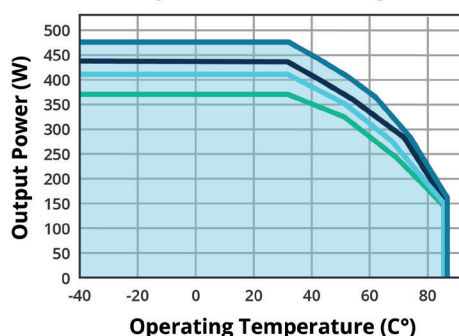

Key

- VGS-500B-18 at 230 Vac
- VGS-500B-18-H at 230 Vac
- VGS-500B-18 at 115 Vac
- VGS-500B-18-H at 115 Vac

INPUT VOLTAGE DERATING CURVE
(natural convection)

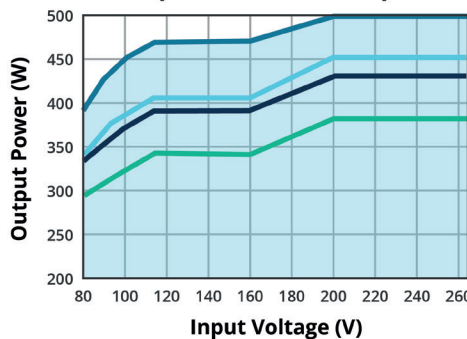

Key

- VGS-500B-24 at 30°C
- VGS-500B-24-H at 30°C
- VGS-500B-24 at 50°C
- VGS-500B-24-H at 50°C

TEMPERATURE DERATING CURVE
(natural convection)

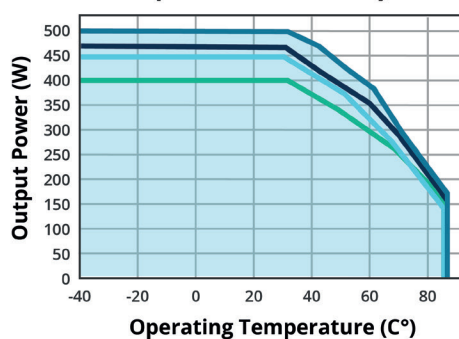

Key

- VGS-500B-24 at 230 Vac
- VGS-500B-24-H at 230 Vac
- VGS-500B-24 at 115 Vac
- VGS-500B-24-H at 115 Vac

DERATING CURVES (CONTINUED)

INPUT VOLTAGE DERATING CURVE
(natural convection)

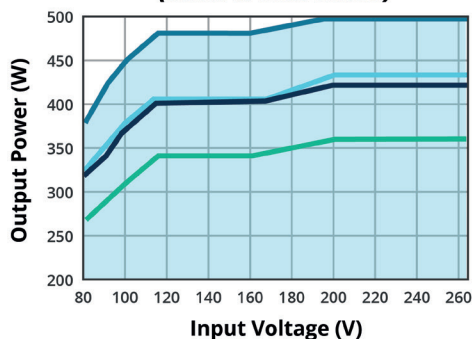

Key

VGS-500B-28 at 30°C
VGS-500B-28-H at 30°C
VGS-500B-28 at 50°C
VGS-500B-28-H at 50°C

TEMPERATURE DERATING CURVE
(natural convection)

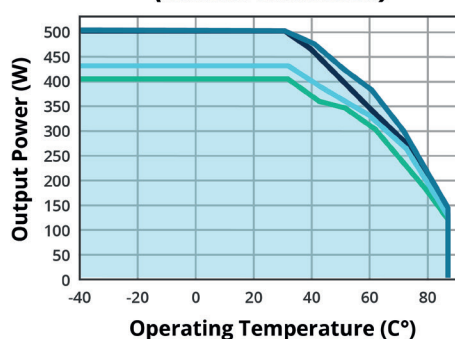

Key

VGS-500B-28 at 230 Vac
VGS-500B-28-H at 230 Vac
VGS-500B-28 at 115 Vac
VGS-500B-28-H at 115 Vac

INPUT VOLTAGE DERATING CURVE
(natural convection)

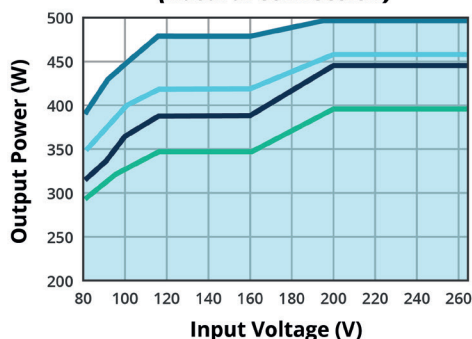

Key

VGS-500B-30 at 30°C
VGS-500B-30-H at 30°C
VGS-500B-30 at 50°C
VGS-500B-30-H at 50°C

TEMPERATURE DERATING CURVE
(natural convection)

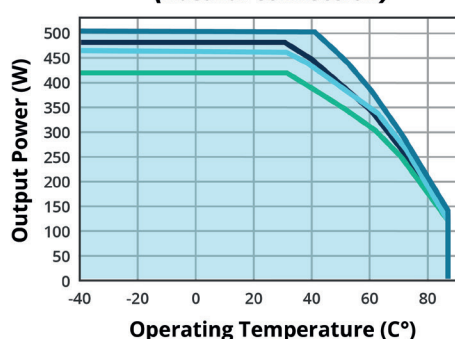

Key

VGS-500B-30 at 230 Vac
VGS-500B-30-H at 230 Vac
VGS-500B-30 at 115 Vac
VGS-500B-30-H at 115 Vac

INPUT VOLTAGE DERATING CURVE
(natural convection)

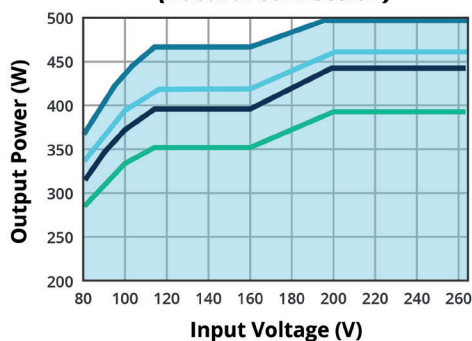

Key

VGS-500B-36 at 30°C
VGS-500B-36-H at 30°C
VGS-500B-36 at 50°C
VGS-500B-36-H at 50°C

TEMPERATURE DERATING CURVE
(natural convection)

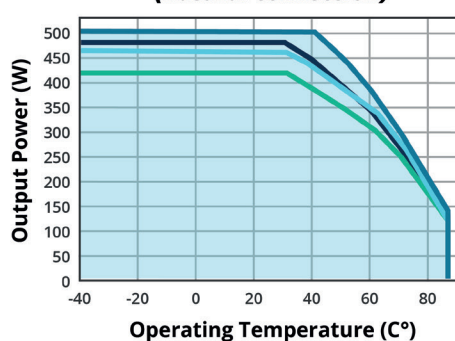

Key

VGS-500B-36 at 230 Vac
VGS-500B-36-H at 230 Vac
VGS-500B-36 at 115 Vac
VGS-500B-36-H at 115 Vac

INPUT VOLTAGE DERATING CURVE
(natural convection)

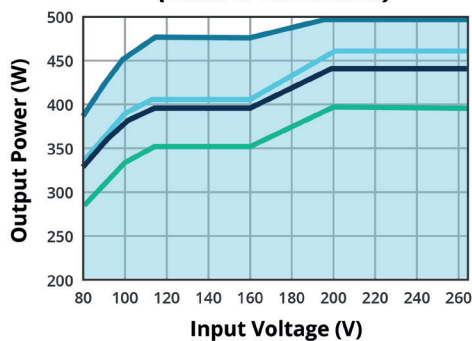

Key

VGS-500B-48 at 30°C
VGS-500B-48-H at 30°C
VGS-500B-48 at 50°C
VGS-500B-48-H at 50°C

TEMPERATURE DERATING CURVE
(natural convection)

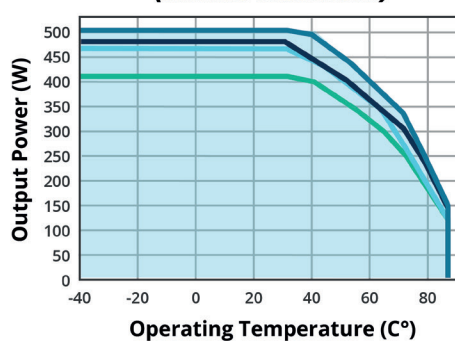

Key

VGS-500B-48 at 230 Vac
VGS-500B-48-H at 230 Vac
VGS-500B-48 at 115 Vac
VGS-500B-48-H at 115 Vac

DERATING CURVES (CONTINUED)

**CASE TEMPERATURE DERATING CURVE
(T_c)**

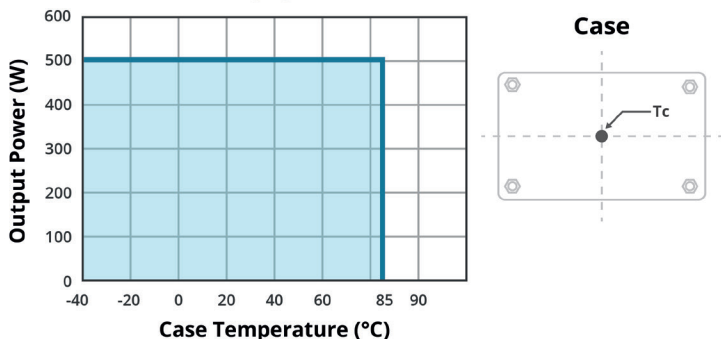

EFFICIENCY CURVES

**EFFICIENCY VS OUTPUT LOAD
(VGS-500B-12)**

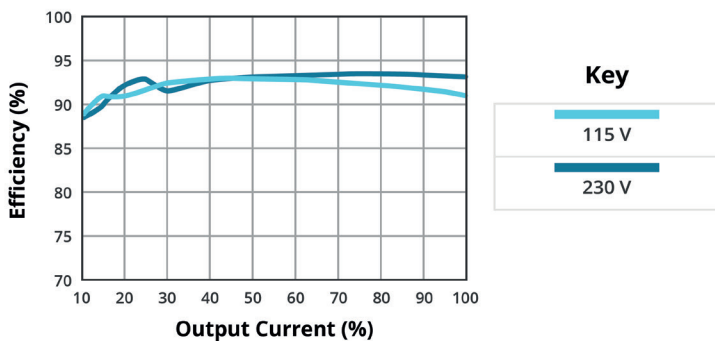

**EFFICIENCY VS OUTPUT LOAD
(VGS-500B-18)**

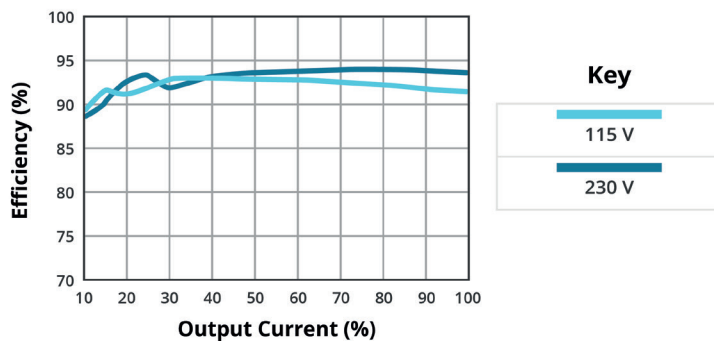

**EFFICIENCY VS OUTPUT LOAD
(VGS-500B-24)**

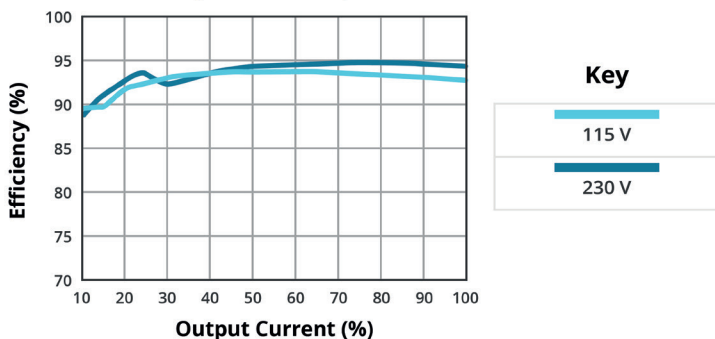

**EFFICIENCY VS OUTPUT LOAD
(VGS-500B-28)**

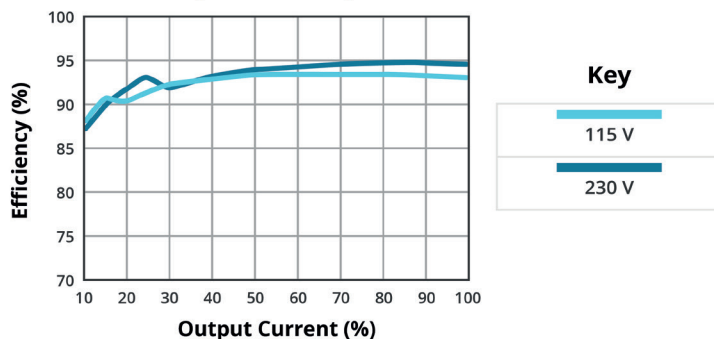

EFFICIENCY CURVES (CONTINUED)

**EFFICIENCY VS OUTPUT LOAD
(VGS-500B-30)**

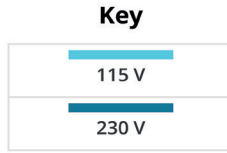
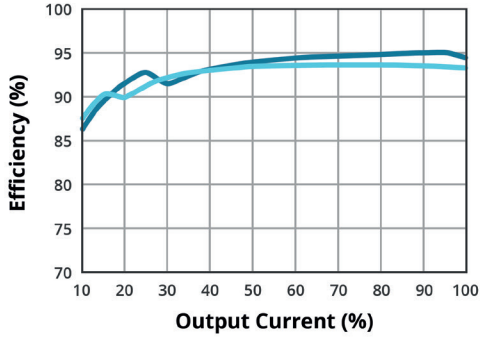

**EFFICIENCY VS OUTPUT LOAD
(VGS-500B-36)**

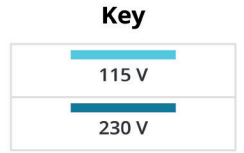
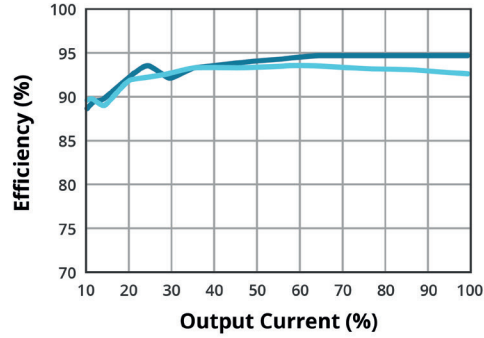

**EFFICIENCY VS OUTPUT LOAD
(VGS-500B-48)**

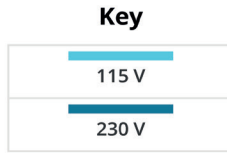
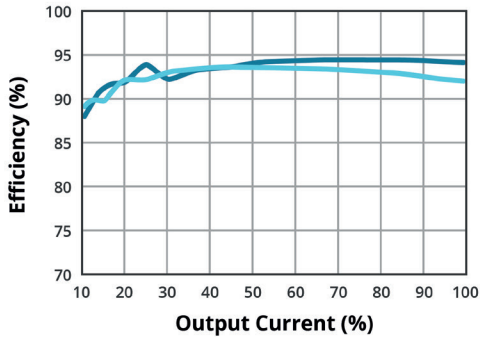

MECHANICAL

parameter	conditions/description	min	typ	max	units
dimensions	5.354 x 3.425x 1.673 inches [136.00 x 87.00 x 42.50 mm]				inch
weight			635		g

MECHANICAL DRAWING

tolerance: inches: x.xxx = ±0.02
mm: x.xx = ±0.5

AC input connector (CN1): JST B2P3-VH or equivalent			
PIN	Function	Mating Housing	Terminal
1	AC (L)	JST VHR-3N or equivalent	JST SVH-41T-P1.1 or equivalent
2	-		
3	AC (N)		

DC Output Connector (CN2): TKP P110I-04 or equivalent			
PIN	Function	Mating Housing	Terminal
1	GND	JST PHR-4 or equivalent	JST SPH-002T-P0.5L or equivalent
2	+5VSB		
3	GND		
4	+12V FAN		

DC Output Connector (CN3):TKP P110L-07 or equivalent			
PIN	Function	Mating Housing	Terminal
1	GND	JST PHR-7 or equivalent	JST SPH-002T-P0.5L or equivalent
2	PF		
3	FAN-EN		
4	PS-ON		
5	-Sense		
6	+Sense		
7	NC or PC (option)		

Note: Pin 7 is PC only in models with parallel control and vertical terminal.

DC Output Connector: KANG YANG PCB-58M4 or equivalent	
Function	Screw Locked Torque
-Vo	M4 7KFG-CM
+Vo	

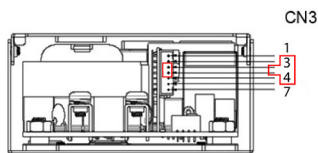
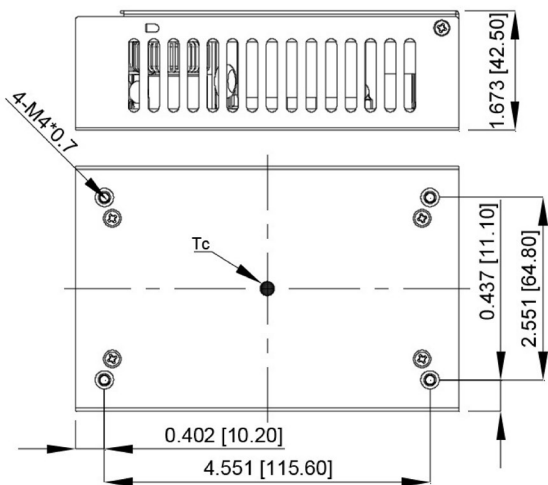
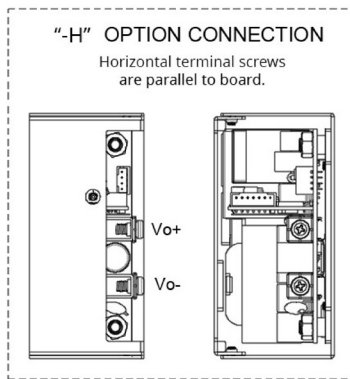
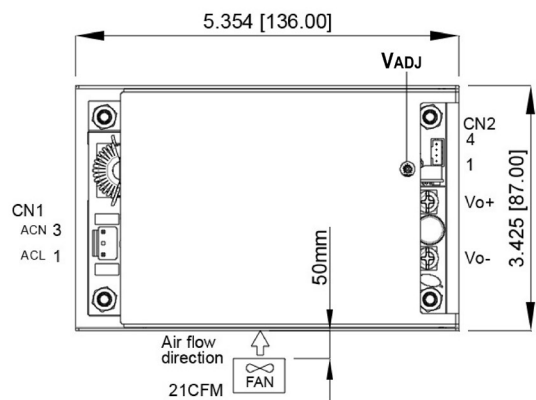

Note: If the jumper on pins 3 & 4 is removed and replaced incorrectly or not at all, issues affecting the function of the part may arise.

PS ON/OFF REMOTE CONTROL AND FAN CONTROL

The PS-ON remote control is provided in CN3 pin 4. The diagram and control function are shown as follow:
 Power ON: $V_{PS-ON} \leq 2\text{ V}$, $I_{PS-ON} \geq 10\text{ mA}$ (PS-ON and GND short, $I_{PS-ON} = 10\text{ mA}$ typical)
 Power OFF: Open circuit, $V_{PS-ON} = 4\text{ V}$

Figure 1

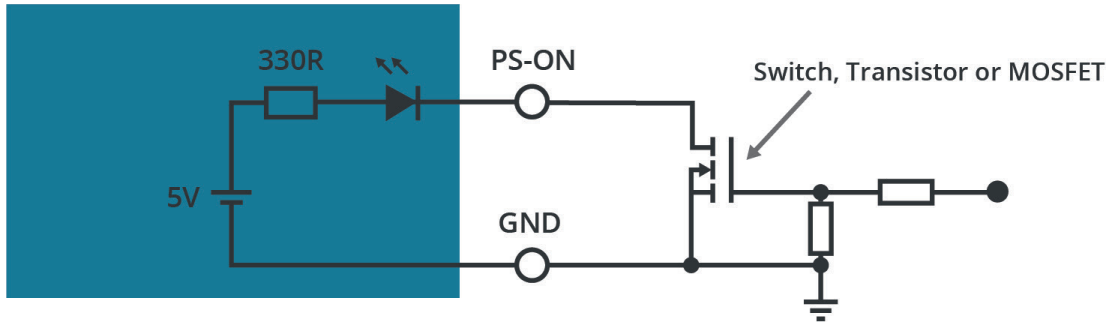

The fan control is provided in CN3 pin 3. The control function and diagram are shown as follow:
 Fan ON: $V_{FAN-EN} \geq 1\text{ V}$
 Fan OFF: Open circuit, $V_{FAN-EN} = 0$

Figure 2

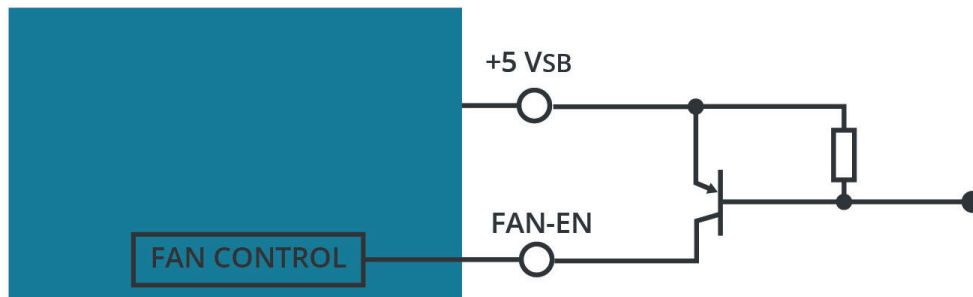

When the PS-ON remote control function is not used, connect a short circuit between the pin PS-ON and FAN-EN.

Figure 3

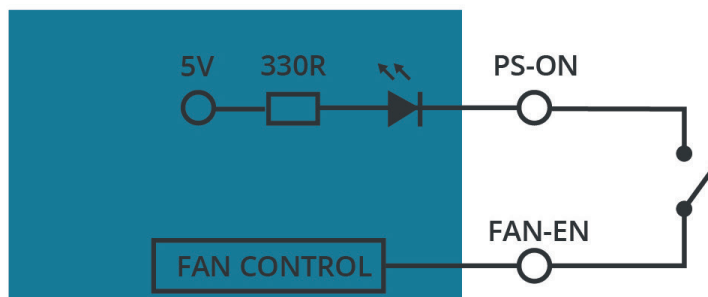

Note: Product is supplied with remote control and fan control disabled via a jumper between PS-ON and FAN-EN (see Figure 3). To use these functions remove jumper and refer to Figures 1 and 2.

PARALLEL CONTROL AND CURRENT SHARING

The optional PC pin may be used to connect multiple power supplies in parallel for current sharing (see Figure 4). For proper operation, only power supplies with the same output voltage should be connected in parallel¹, the total output power should be limited to 90% of the total rated power², and the remote sensing feature should not be utilized³. For reliable operation, it is also suggested that the remote on/off feature be used to synchronize the outputs during turn on and turn off.

Figure 4
Connection diagram for parallel operation and current sharing

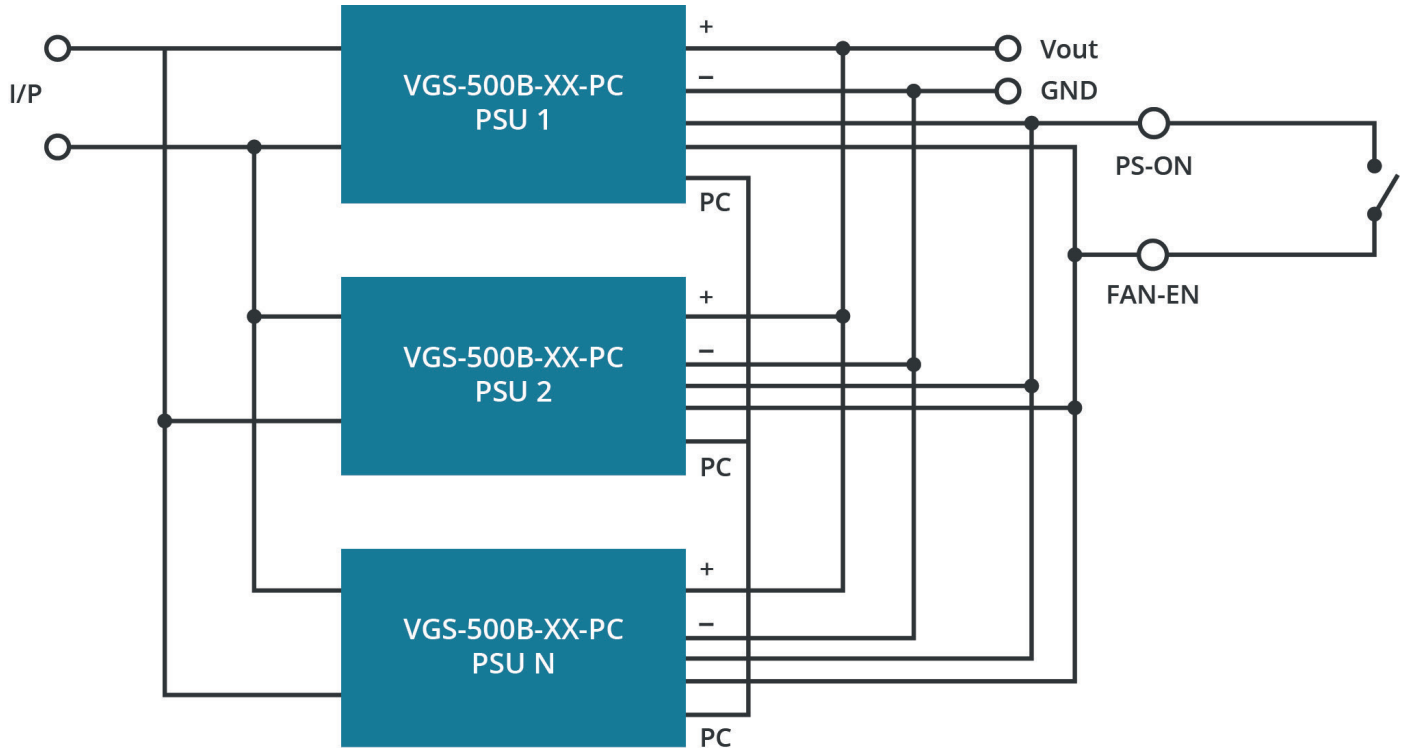

- Notes:
1. Output voltage of all power supplies should be within 0.2 V of each other at no load.
 2. Total output power $\leq P_{o, \text{rated}} \times N \times 0.9$.
 3. Leave +Sense and -Sense pins open when current sharing.
 4. It is recommended to use the PS-ON pin to enable/disable the power supplies output when current sharing. See Figure 4.

REVISION HISTORY

rev.	description	date
1.0	initial release	08/16/2024
1.01	parallel control & adjustability added	08/27/2024

The revision history provided is for informational purposes only and is believed to be accurate.



CUI INC

a bel group

Headquarters

15575 SW Sequoia Pkwy #100
Portland, OR 97224
800.275.4899

Fax 503.612.2383
cui.com
techsupport@cui.com

CUI offers a two (2) year limited warranty. Complete warranty information is listed on our website.

CUI reserves the right to make changes to the product at any time without notice. Information provided by CUI is believed to be accurate and reliable. However, no responsibility is assumed by CUI for its use, nor for any infringements of patents or other rights of third parties which may result from its use.

CUI products are not authorized or warranted for use as critical components in equipment that requires an extremely high level of reliability. A critical component is any component of a life support device or system whose failure to perform can be reasonably expected to cause the failure of the life support device or system, or to affect its safety or effectiveness.

X-ON Electronics

Largest Supplier of Electrical and Electronic Components

Click to view similar products for [Switching Power Supplies](#) category:

Click to view products by [CUI Inc](#) manufacturer:

Other Similar products are found below :

[70841011](#) [73-551-0005](#) [73-551-0048](#) [73-558-0015I](#) [EVS57-5R3/A](#) [FAS-002](#) [AAD600S-4-OP](#) [MS924](#) [HWS50A-5/RA](#) [KD0204](#) [9021](#)
[LDIN100150](#) [FAP-001](#) [FP80](#) [FRV7000G](#) [22929](#) [PS3E-F12F](#) [CQM1IA121](#) [LDIN5075](#) [432703037161](#) [VI-LUL-IU](#) [LPM000-BBAR-08](#)
[LPM000-BBAR-07](#) [08-30466-1055G](#) [DMB-EWG](#) [CQM1IPS01](#) [SP-300-5](#) [MAP40-S233](#) [CQM1-IPS02](#) [73-551-0024I](#) [VI-MUL-ES](#) [22829](#)
[08-30466-0028G](#) [96PSR-A460WOTH-2](#) [G06-Q01](#) [GHA300F-12-SNF](#) [MP650-2K2K](#) [MTA040009A](#) [FSA150024A](#) [VI-RUR22-EWXX](#)
[HLS30ZE-NT8](#) [UT1404-7](#) [ERP-350-12](#) [S8FSG01512C](#) [S8FSG03012C](#) [XPFM201A+](#) [S8FS-G15015C](#) [S8FS-G05005C](#) [S8FS-G03015C](#) [08-](#)
[30466-020WG](#)