

SERIES: VMS-550 | **DESCRIPTION:** AC-DC POWER SUPPLY**FEATURES**

- up to 550 W continuous power
- -40°C to 70°C operating temperature
- industry standard foot print 3" x 5"
- low profile 1.5"
- power factor correction
- 12 V/0.5 A fan output
- standby power <0.5 W
- efficiency up to 92%
- long life electrolytic capacitors
- complying with the latest EMI standard IEC 60601-1-2:2014 (4th edition)



MODEL	output voltage	output current	output power ^{1,2}	ripple and noise ^{3,4}	efficiency
	(Vdc)	max (A)	max (W)	max (mVp-p)	typ (%)
VMS-550-12	12	41.67	500	240	90
VMS-550-15	15	33.33	500	300	90
VMS-550-24	24	22.92	550	240	91
VMS-550-30	30	18.33	550	300	91
VMS-550-48	48	11.46	550	480	92
VMS-550-58	58	9.48	550	580	92

Notes:

1. Maximum output power with 21 CFM forced air cooling. See derating curves for full performance details.
2. Combined output power of main output and fan supply shall not exceed the max power rating.
3. Ripple is peak to peak with 20 MHz bandwidth and 10 μ F tantalum capacitor in parallel with a 0.1 μ F capacitor at rated line voltage and load ranges.
4. Output ripple can be more than 10% of the output voltage at -40°C.
5. All specifications are measured at Ta=25°C, nominal input voltage, and rated output load unless otherwise specified.

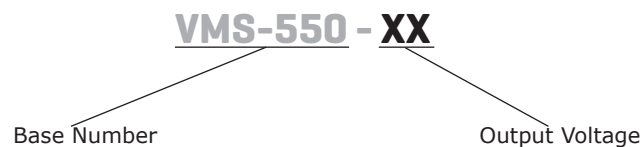
PART NUMBER KEY

INPUT

parameter	conditions/description	min	typ	max	units
voltage		90		264	Vac
frequency		47		63	Hz
current	at 115 Vac, full load at 230 Vac, full load		6 3		A A
inrush current	at 230 Vac, cold start			45	A
leakage current	at 115 Vac at 230 Vac			0.2 0.4	mA mA
touch current				0.1	mA
power factor	at full load	0.95			
no load power consumption				0.7	W
input fuse	8 A/250 V time delay fuse (included)				

OUTPUT

parameter	conditions/description	min	typ	max	units
initial set point accuracy			±1		%
line regulation			±0.5		%
load regulation	from 100% to 10% load		±1		%
start-up delay time			2		s
rise time	at 115/230 Vac		55		ms
hold-up time	at 115/230 Vac, full load		16		ms
adjustability	built in trim pot		±3		%
switching frequency		50		300	kHz
transient response	25% step load change, at 0.1 A/μS slew rate, 50% duty cycle, 50/60 Hz, max excursion 4%, recovery time 5 ms				
temperature coefficient	at 0~50°C		±0.05		%/°C
fan output ¹	12 Vdc / 500 mA				

Notes: 1. Fan supply output voltage tolerance including set point accuracy, line and load regulation is ±10% and ripple and noise is less than 10%.

PROTECTIONS

parameter	conditions/description	min	typ	max	units
over voltage protection	hiccup, auto recovery	110		140	%
over current protection	hiccup, auto recovery	110			%
short circuit protection	hiccup, auto recovery				
over temperature protection	goes into hiccup mode when the temperature of the PCB exceeds 110±10°C, auto recovery				

SAFETY & COMPLIANCE

parameter	conditions/description	min	typ	max	units
isolation voltage	input to output (2 x MOPP) input to ground (1 x MOPP) output to ground		4,200 1,500 1,500		Vac Vac Vac
safety approvals	IEC 60601-1: 2005 +CORR1:2006 +CORR2:2007 +AM1:2012, EN 60601-1:2006 +A11:2011 +A1:2013, ANSI/AAMI ES 60601-1 (2005+CI:09+A2:10), AMD1:2012 CAN/CSA- C22.2 No 60601-1 (2008) 60601-1:14 ISO 14971, 2nd edition complies with LVD directive				
safety class	class I				

Notes: 2. The power supply is considered a component which will be installed into final equipment. The final equipment still must be tested to meet the necessary EMC directives.

SAFETY & COMPLIANCE

parameter	conditions/description	min	typ	max	units
conducted emissions	EN 55011 Class B				
radiated emissions	EN 55011 Class B (to be controlled in end system with external core (King core K5B RC 25 x 12 x 15-M in input cable (5 turns)))				
input current harmonics	EN 61000-3-2, class D				
voltage fluctuation and flicker	EN 61000-3-3, pass				
ESD immunity	EN 61000-4-2, level 4, criterion A				
radiated field immunity	EN 61000-4-3, level 4, criterion A				
electrical fast transient immunity	EN 61000-4-4, level 4, criterion A				
surge immunity	EN 61000-4-5, level 4, criterion A				
conducted immunity	EN 61000-4-6, level 4, criterion A				
magnetic field immunity	EN 61000-4-8, level 4, criterion A				
voltage dips, interruptions	EN 61000-4-11, criterion A & B				
MTBF	as per Telcordia-SR332-issue 3		3,370,000		hours
RoHS	2011/65/EU				

Notes: 1. The power supply is considered a component which will be installed into final equipment. The final equipment still must be tested to meet the necessary EMC directives.

ENVIRONMENTAL

parameter	conditions/description	min	typ	max	units
operating temperature	see derating curves	-40		70	°C
storage temperature		-40		85	°C
operating humidity	non-condensing	20		90	%
storage humidity	non-condensing	20		90	%
operating altitude				16,000	ft

DERATING CURVES

TEMPERATURE DERATING CURVE
(12 & 15 Vdc output models)

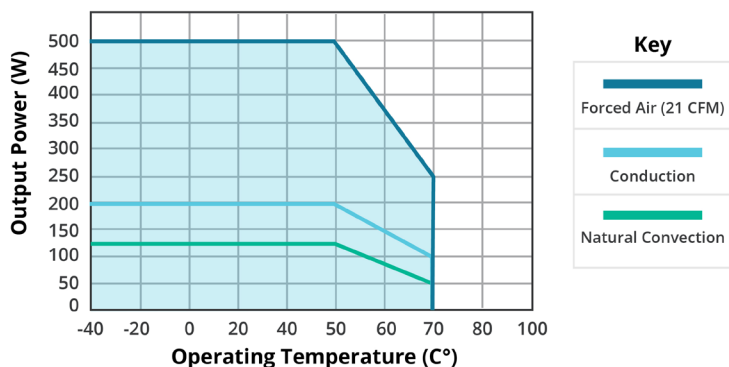

TEMPERATURE DERATING CURVE
(all other output models)

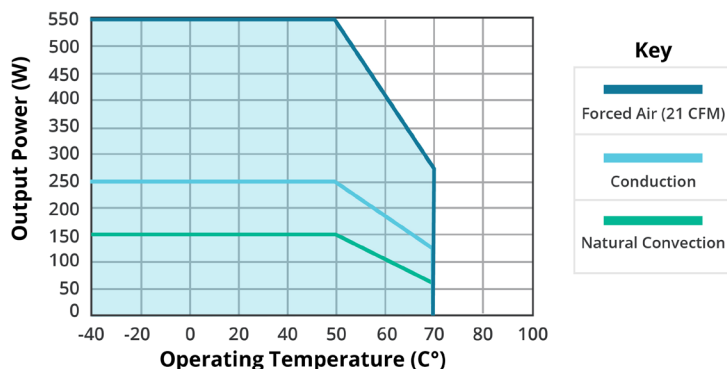

DERATING CURVES (CONTINUED)

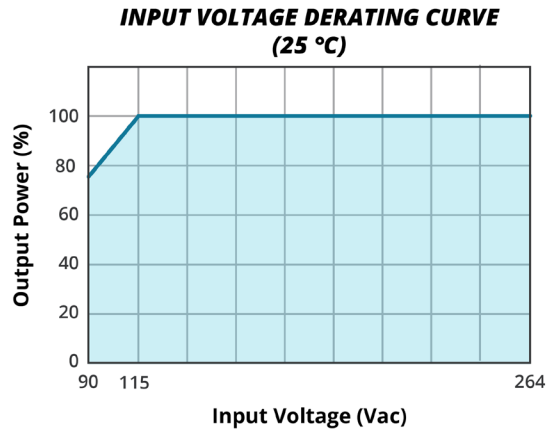

MECHANICAL

parameter	conditions/description	min	typ	max	units
dimensions	5.00 x 3.00 x 1.50 (127.00 x 76.20 x 38.10 mm)				inch
weight			400		g
cooling	external fan or conduction plate				
J1 input connector	Mates with JST housing VHR-3M; pins SVH-41T-P1.1 or equivalent				
J2 output connector	Accepts ring tongue terminal AMP 8-31886-1 for max 16 AWG wire up to 11 A. Use multiple terminals for higher currents.				
J3 fan connector	Mates with Tyco 640440-2				

MECHANICAL DRAWING

units: inch [mm]
tolerance: ±0.04 [±1.0]

J1	
PIN	Function
1	L
2	NC
3	N

J2	
PIN	Function
1	+VE
2	-VE

J3	
PIN	Function
1	+FAN
2	-FAN

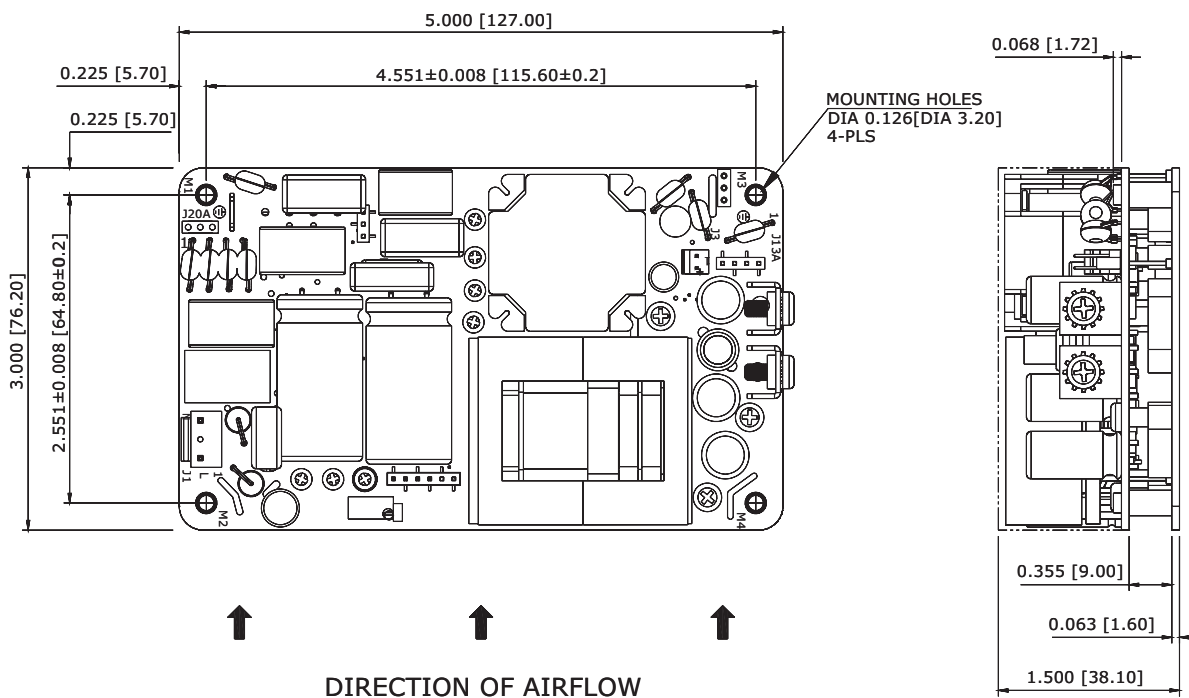

RECOMMENDED CONDUCTION PLATE AND CLEARANCE

The conduction power rating referenced in the derating curves is with additional aluminum base plate of 3 mm thickness with 177.8 mm (7") length & 101.6 mm (4") width. Clearance of minimum 15 mm above the component height is recommended for better thermal management.

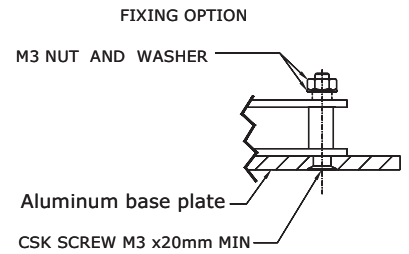
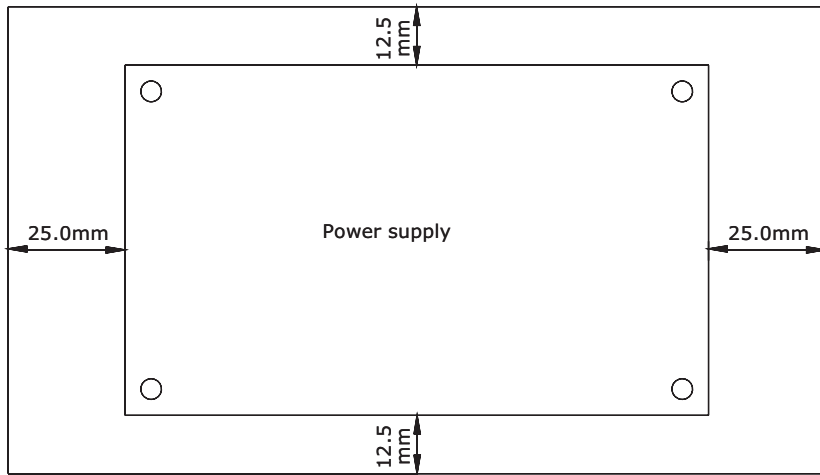
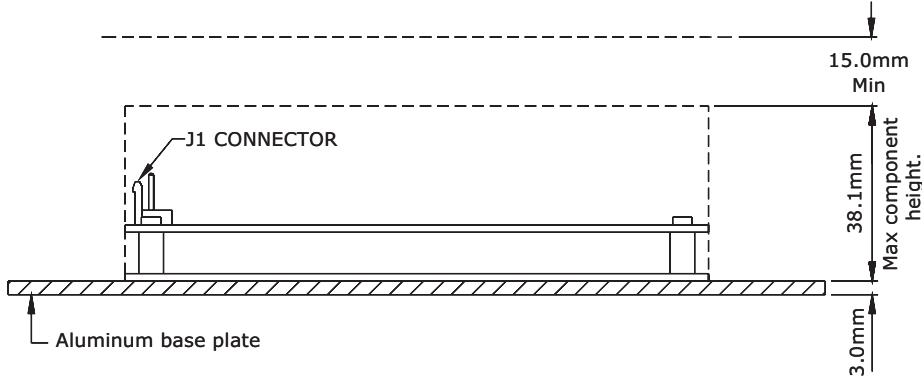

MOUNTING OPTIONS

FIXING OPTION -1

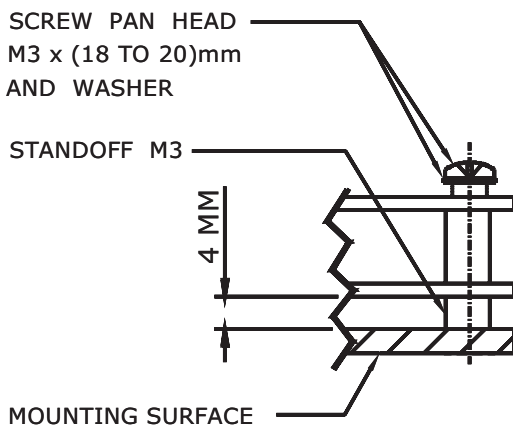

FIXING OPTION -2

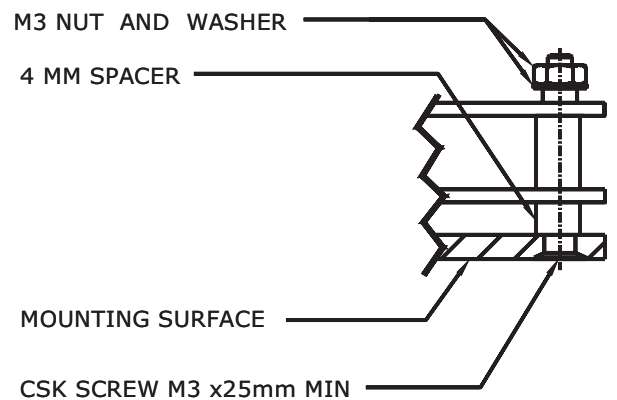

REVISION HISTORY

rev.	description	date
1.0	initial release	09/05/2017
1.01	company logo updated	12/17/2020
1.02	derating curves updated	04/23/2021

The revision history provided is for informational purposes only and is believed to be accurate.



CUI INC

a bel group

Headquarters

20050 SW 112th Ave.
Tualatin, OR 97062
800.275.4899

Fax 503.612.2383

cui.com

techsupport@cui.com

CUI offers a two (2) year limited warranty. Complete warranty information is listed on our website.

CUI reserves the right to make changes to the product at any time without notice. Information provided by CUI is believed to be accurate and reliable. However, no responsibility is assumed by CUI for its use, nor for any infringements of patents or other rights of third parties which may result from its use.

CUI products are not authorized or warranted for use as critical components in equipment that requires an extremely high level of reliability. A critical component is any component of a life support device or system whose failure to perform can be reasonably expected to cause the failure of the life support device or system, or to affect its safety or effectiveness.

X-ON Electronics

Largest Supplier of Electrical and Electronic Components

Click to view similar products for [AC/DC Power Modules](#) category:

Click to view products by [CUI Inc](#) manufacturer:

Other Similar products are found below :

[VI-HAM-CM](#) [ERP-350-12](#) [KPSB25-12-J](#) [KPSB25-15-J](#) [KPSB25-24-J](#) [KPSB25-36-J](#) [KPSB25-5-J](#) [KPSB6-12-J](#) [KPSB6-5-J](#) [TPP 65-112E-D](#)
[RAC05-05SK/PD3/H](#) [AMEOF65-12SJZ](#) [AMEL10-12S277HAVZ-B](#) [RAC05-12SK/PD3/H](#) [AMEL20-3S277HAVZ-B](#) [AMEL20-5S277HAVZ-](#)
[B](#) [AMEL45-24SJZ](#) [AMEL30-12S277HAVZ](#) [AMEL30-15S277HAVZ](#) [AMEL30-3S277HAVZ](#) [AMEL30-5S277HAVZ](#) [AMEL30-](#)
[9S277HAVZ](#) [AMEM5-9S277HAVZ-B](#) [AMESP100-24S277NZ](#) [AMESP100-48S277NZ](#) [AMESP150-24S277NZ](#) [AMESP200-24S277NZ](#)
[AMESP320-24S277NZ](#) [AMESP320-48S277NZ](#) [AMESP75-12S277NZ](#) [AMESP75-24S277NZ](#) [AMESP75-48S277NZ](#) [AM20CW-2405S-NZ](#)
[AMEL60-24SJZ](#) [AMEL60-48SJZ](#) [AMEM3-15S277HAVZ-B](#) [AMEM3-24S277HAVZ-B](#) [AMEM3-3S277HAVZ-B](#) [AMEM3-9S277HAVZ-B](#)
[AMEM5-12S277HAVZ-B](#) [AMEM5-15S277HAVZ-B](#) [AMEM5-24S277HAVZ-B](#) [AMEM5-5S277HAVZ-B](#) [AMEOF225-12SHAMJZ](#)
[AME20-3.3SBJZ](#) [AME20-5SBJZ](#) [AMEL15-24S277HAVZ-B](#) [AMEL15-5S277HAVZ-ST](#) [AMEL20-12S277HAVZ-B](#) [AMEL20-](#)
[24S277HAVZ-B](#)