

Multilayer Chip Ferrite Bead



◆ **Features**

- 1、 Internal silver printed layers and magnetic shielded structures to minimize crosstalk
- 2、 It has sharp impedance characteristics at desirable frequency and does not affect the signal frequency
- 3、 SMD Type & suitable for reflow and wave soldering
- 4、 Four types material and wide range of impedance values for various applications
- 5、 Excellent solderability and heat resistance
- 6、 RoHS Compliant.



◆ **Application**

Filtering between analog and digital circuitry, clock Generation circuitry, I/O interconnects, isolation between RF noisy circuits and logic devices susceptible to functional degradation, power supply filtering to prevent conducted RF energy from corrupting the power generation circuitry, high frequency EMI prevention of computer, printers, VCRs, TVs and portable telephones.

◆ **PRODUCT IDENTIFICATION**

CMBM 2012 G 601 H S P
(1) (2) (3) (4) (5) (6) (7)

- (1) Series Type
- (2) Chip Size (mm) :Length X Width
- (3) Material Code
- (4) Nominal Impedance:601=600Ω;
102=1000Ω
- (5) Rated Curren: A=50mA; B=100mA;C=150mA;
D=200mA;E=300mA;F=400mA;
G=500mA;H=600mA;I=700mA;
J=800mA;K=900mA;L=1000mA.
- (6) Company Code
- (7) Packaging: E- Embossed plastic tape, 7" reel
P – Embossed paper tape, 7" reel

◆ **Dimensions** Unit: mm

Size(EIA)	L	W	T	E
2012(0805)	2.00±0.20	1.25±0.20	0.90±0.20	0.50±0.30

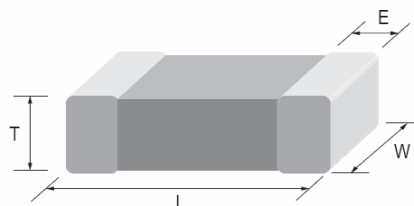

◆ Specification

Part Number	Impedance (Ω)	Test Frequency (MHz)	DCR Max. (Ω)	Rated Current (mA)
CMBM2012 Series				
CMBM2012G050LSP	0~15	100	0.07	1000
CMBM2012G300LSP	30±25%	100	0.10	1000
CMBM2012G600JSP	60±25%	100	0.20	800
CMBM2012G121JSP	120±25%	100	0.22	800
CMBM2012G221HSP	220±25%	100	0.25	600
CMBM2012G301HSP	300±25%	100	0.30	600
CMBM2012G421HSP	420±25%	100	0.30	600
CMBM2012G601HSP	600±25%	100	0.35	600
CMBM2012G102FSP	1000±25%	100	0.40	500
CMBM2012G152DSP	1500±25%	100	0.45	200
CMBM2012G222DSP	2200±25%	100	0.60	200
CMBM2012G252DSP	2500±25%	100	0.70	200
CMBM2012G272DSP	2700±25%	100	0.80	200

◆ General Technical Data

Operating Temperature Range	-55°C ~ +125°C
Storage Condition	Less than 40°C and 70% RH
Soldering Method	Reflow or Wave Soldering

◆ Recommended Soldering Conditions

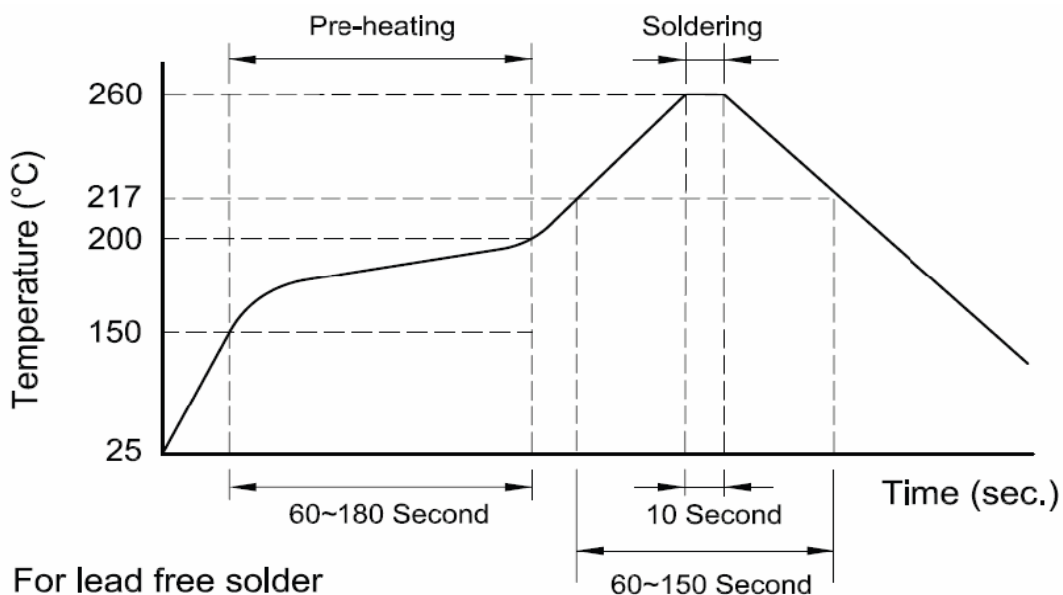

◆ Characteristics

CMBM2012 TYPE

CMBM2012G050LSP

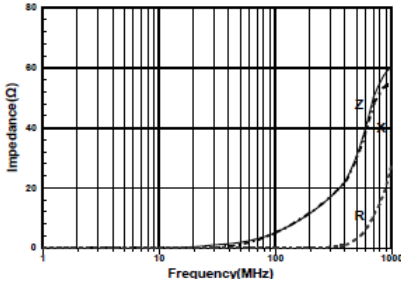

CMBM2012G300LSP

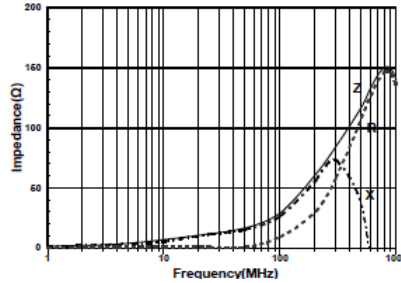

CMBM2012G600JSP

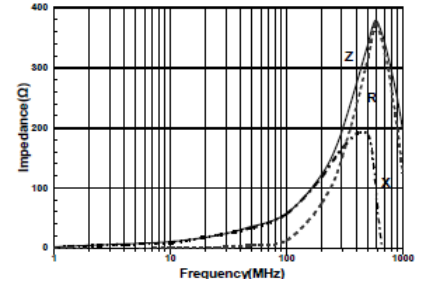

CMBM2012G121JSP

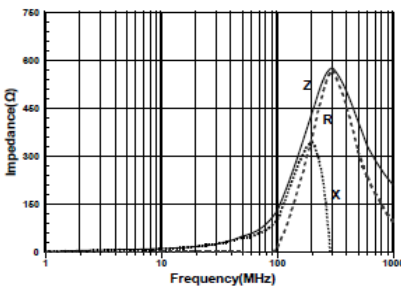

CMBM2012G221HSP

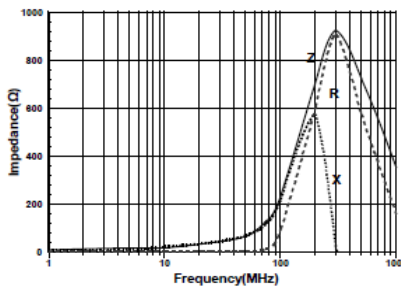

CMBM2012G301HSP

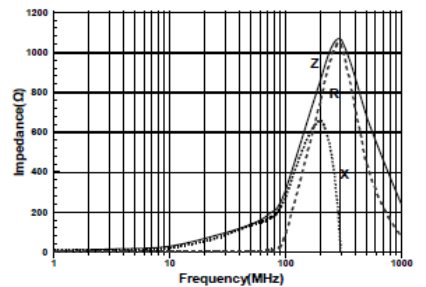

CMBM2012G421HSP

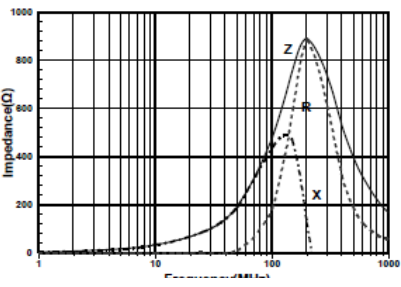

CMBM2012G601HSP

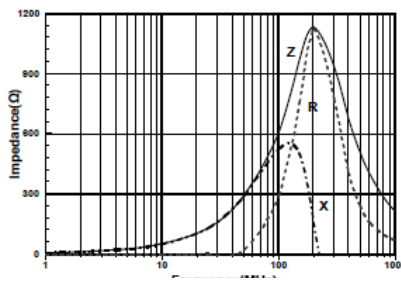

CMBM2012G102FSP

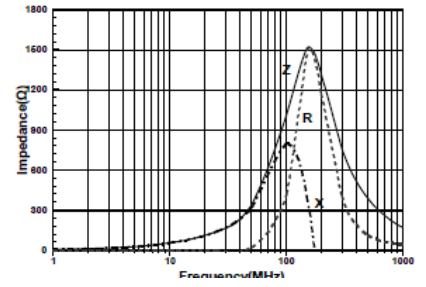

CMBM2012G152DSP

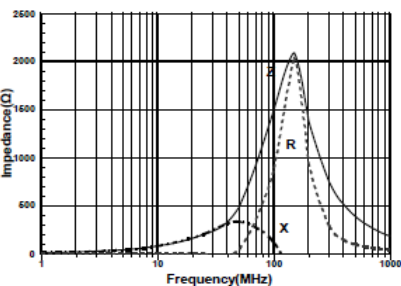

CMBM2012G222DSP

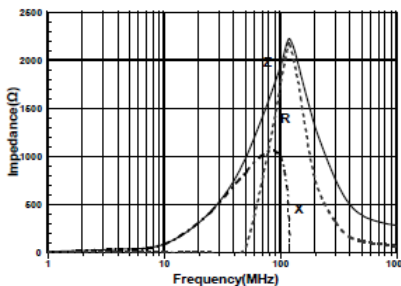

CMBM2012G252DSP

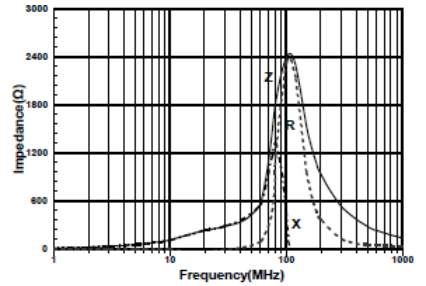

CMBM2012G272DSP

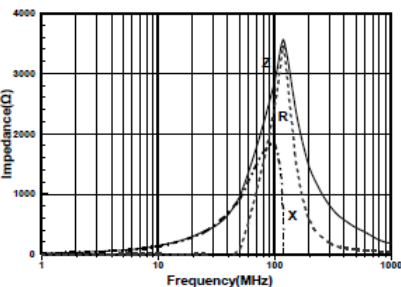

◆ Packaging

Tape Carrier Packaging:

Packaging code: T

- a. Tape carrier packaging are specified in attached figure
- b. Tape carrier packaging quantity please see the following table

Type	2012(0805)
T(mm)	0.9±0.1
Tape	Paper Tape
Quantity	4K

(1) Taping Drawings (Unit: mm)

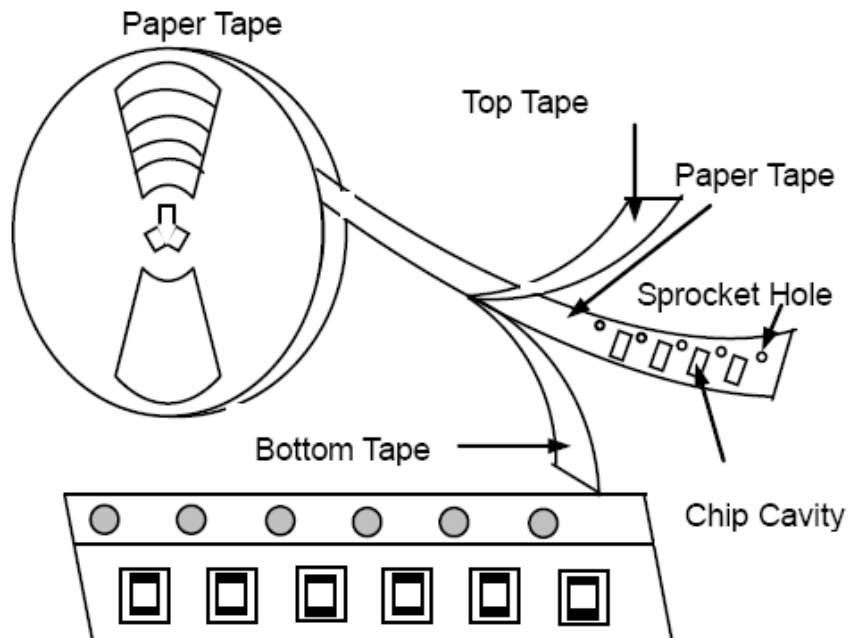

Remark: The sprocket holes are to the right as the tape is pulled toward the user.

(2) Taping Dimensions (Unit: mm)

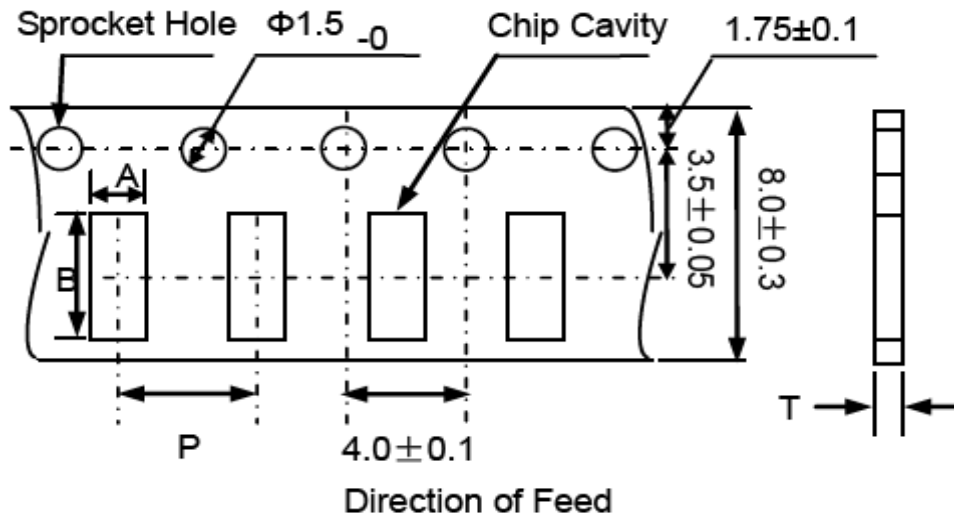

Paper Tape

Type	A	B	P	T max
2012(0805)	1.6 ± 0.1	2.3 ± 0.1	4.0 ± 0.1	0.8

(3) Reel Dimensions (Unit: mm)

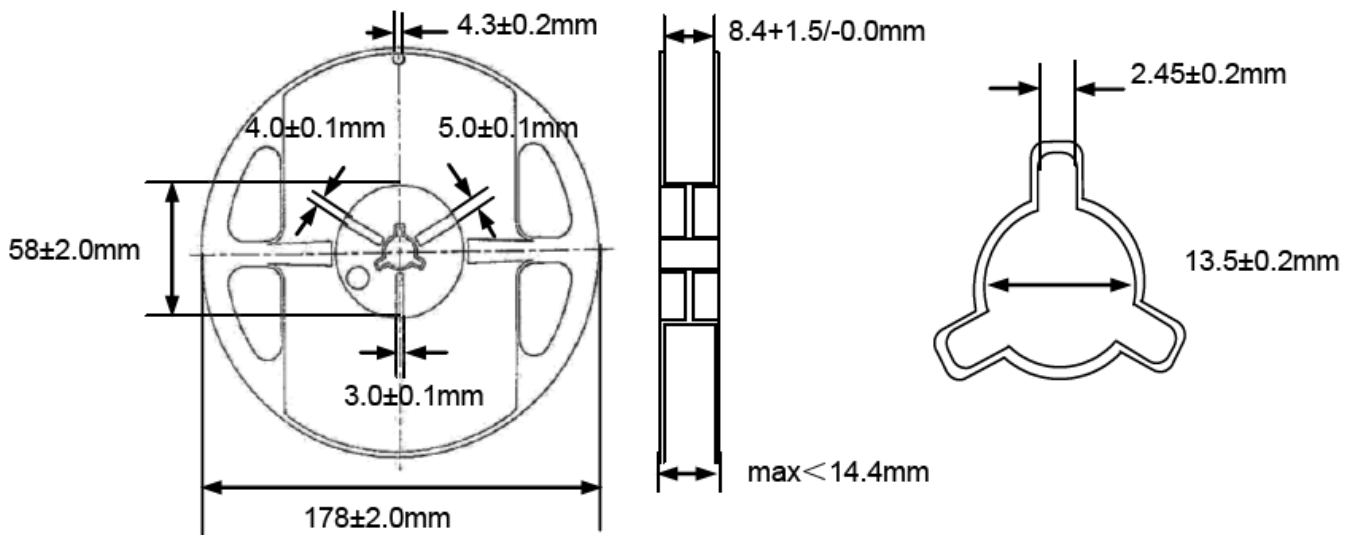

X-ON Electronics

Largest Supplier of Electrical and Electronic Components

Click to view similar products for [Ferrite Beads](#) category:

Click to view products by [Cybermax](#) manufacturer:

Other Similar products are found below :

[2943778301](#) [BMB1J0120BN3JIT](#) [82350120560](#) [0261014605](#) [2643066902](#) [3061000011](#) [2673045901](#) [2643083601](#) [2643074901](#) [4361142521](#)
[4078078621](#) [4078044821](#) [4078033621](#) [CZB2BFTTE121P](#) [BMB2A0120AN2](#) [BMB1J0200BN3JIT](#) [EMI0805R-220](#) [74279250](#) [7427924](#)
[CZB1JGTTD202P](#) [MAF0603GWY551AT000](#) [MAF1005GWZ102AT000](#) [BLM18HE152SH1D](#) [2944778302](#) [BLM02PX600SN1D](#) [SMB2.5-1](#)
[EMI1206R-600](#) [BLM02KX180SN1D](#) [BLM02BC100SN1D](#) [BLM02KX100SN1D](#) [BLM02BB101SN1D](#) [BLM02BC220SN1D](#)
[BLE32PN260SH1L](#) [BLE32PN260SN1L](#) [BLE32PN260SZ1L](#) [74275013](#) [7427503](#) [BLM18HE601SH1D](#) [BLM15BD152SN1D](#)
[BLM15BD152SZ1D](#) [BLE18PS080SZ1D](#) [BLM21PG221BH1D](#) [WLBD1005HCU330TL](#) [BLM21AG471BH1D](#) [BLE18PS080BH1D](#)
[BLM21AG331BH1D](#) [BLM21PG300BH1D](#) [BLM21PG600BH1D](#) [BLM03HB401SZ1D](#) [BLM03HB401SN1D](#)