

**Multilayer Chip Ceramic Inductor**



◆ **Features**

- 1、 Monolithic Structure for high reliability
- 2、 High self-resonant frequency
- 3、 Excellent solderability and high heat resistance
- 4、 RoHS Compliant.



◆ **Application**

- 1、 RF Circuit of in telecommunication and other Equipments

◆ **PRODUCT IDENTIFICATION**

**CMCC 0603 C 1N0 S S P**  
**(1) (2) (3) (4) (5) (6) (7)**

- (1) Series Type
- (2) Chip Size (mm) :Length X Width
- (3) Material Code
- (4) Inductance: 1N0=1nH; 10N=10nH  
R10=100nH
- (5) Inductance Tolerance: B=±0.1; C=±0.2; S=±0.3;  
G=±2%; H=±3%; J=±5%
- (6) Company Code
- (7) Packaging:P–Embossed paper tape, 7" reel  
E- Embossed plastic tape, 7" reel

◆ **Dimensions Unit: mm**

Size(EIA)	L	W	T	E
	0.60±0.05	0.30±0.05	0.30±0.05	0.20±0.10

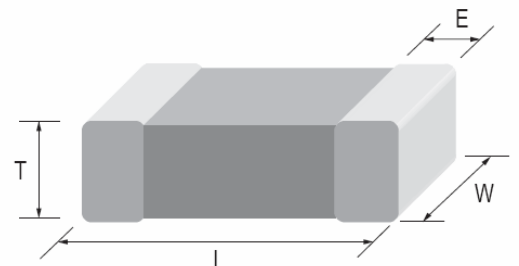

◆ Specifications

Part Number	Inductance (nH)	Min. Quality Factor (Q)	L, Q Test Freq. L/Q(MHz)	Typical Q @ Freq. (GHz)					Min. Self-resonant Frequency (MHz)	Max. DC Resistance (Ω)	Max. Rated Current (mA)
				0.5	0.8	1.8	2.0	2.4			
				Q							
<b>CMCC0603 Series</b>											
CMCC0603C0N6◇SP	0.6	13	500	>24	>32	>54	>57	>65	10000	0.06	600
CMCC0603C0N7◇SP	0.7	13	500	>24	>32	>54	>57	>65	10000	0.06	550
CMCC0603C0N8◇SP	0.8	13	500	>24	>32	>54	>57	>65	10000	0.07	550
CMCC0603C0N9◇SP	0.9	13	500	>24	>32	>54	>57	>65	10000	0.07	550
CMCC0603C1N0◇SP	1.0	13	500	24	32	54	57	65	10000	0.08	520
CMCC0603C1N1◇SP	1.1	13	500	19	26	45	47	55	10000	0.11	440
CMCC0603C1N2◇SP	1.2	13	500	19	25	43	44	52	10000	0.12	420
CMCC0603C1N3◇SP	1.3	13	500	19	25	40	42	47	10000	0.12	420
CMCC0603C1N4◇SP	1.4	13	500	19	24	39	41	47	10000	0.11	440
CMCC0603C1N5◇SP	1.5	13	500	19	24	39	41	46	10000	0.12	420
CMCC0603C1N6◇SP	1.6	13	500	19	24	39	41	46	10000	0.13	410
CMCC0603C1N7◇SP	1.7	13	500	19	24	39	41	46	10000	0.15	380
CMCC0603C1N8◇SP	1.8	13	500	19	24	39	41	46	10000	0.15	380
CMCC0603C1N9◇SP	1.9	13	500	18	24	38	40	45	10000	0.18	350
CMCC0603C2N0◇SP	2.0	13	500	17	24	38	39	44	10000	0.23	300
CMCC0603C2N1◇SP	2.1	13	500	17	24	37	39	44	10000	0.24	300
CMCC0603C2N2◇SP	2.2	13	500	17	24	38	40	43	10000	0.25	290
CMCC0603C2N3◇SP	2.3	13	500	17	24	37	39	43	10000	0.20	330
CMCC0603C2N4◇SP	2.4	13	500	17	23	36	38	42	10000	0.22	310
CMCC0603C2N5◇SP	2.5	13	500	17	23	35	36	40	9600	0.20	330
CMCC0603C2N6◇SP	2.6	13	500	17	22	34	35	39	9400	0.20	330
CMCC0603C2N7◇SP	2.7	13	500	17	22	34	35	39	9200	0.22	310
CMCC0603C2N8◇SP	2.8	13	500	17	22	34	35	39	8900	0.24	300
CMCC0603C2N9◇SP	2.9	13	500	17	22	34	35	39	8800	0.26	280

◆ Specifications

Part Number	Inductance (nH)	Min. Quality Factor (Q)	L, Q Test Freq. L/Q(MHz)	Typical Q @ Freq. (GHz)					Min. Self-resonant Frequency (MHz)	Max. DC Resistance (Ω)	Max. Rated Current (mA)
				0.5	0.8	1.8	2.0	2.4			
				Q							
<b>CMCC0603 Series</b>											
CMCC0603C2N9◇SP	2.9	13	500	17	22	34	35	39	8800	0.26	280
CMCC0603C3N0◇SP	3.0	13	500	17	22	34	35	39	8600	0.26	280
CMCC0603C3N1◇SP	3.1	13	500	17	22	34	35	39	8500	0.28	270
CMCC0603C3N2◇SP	3.2	13	500	17	22	33	35	39	8200	0.28	270
CMCC0603C3N3◇SP	3.3	13	500	18	23	34	36	40	8100	0.30	270
CMCC0603C3N4◇SP	3.4	13	500	17	23	33	35	39	8000	0.30	270
CMCC0603C3N5◇SP	3.5	13	500	17	23	33	35	39	7900	0.34	250
CMCC0603C3N6◇SP	3.6	13	500	16	23	33	35	39	7700	0.38	240
CMCC0603C3N7◇SP	3.7	13	500	16	23	33	35	38	7600	0.40	230
CMCC0603C3N8◇SP	3.8	13	500	16	22	33	35	38	7500	0.42	230
CMCC0603C3N9◇SP	3.9	13	500	16	22	33	35	38	7400	0.42	230
CMCC0603C4N3◇SP	4.3	13	500	16	21	32	34	37	6800	0.44	220
CMCC0603C4N7◇SP	4.7	13	500	16	22	33	35	38	6200	0.45	220
CMCC0603C5N1◇SP	5.1	13	500	17	22	34	36	38	5900	0.46	210
CMCC0603C5N6◇SP	5.6	13	500	16	21	33	34	37	5500	0.46	210
CMCC0603C6N2◇SP	6.2	13	500	18	23	34	35	37	5100	0.48	210
CMCC0603C6N8◇SP	6.8	13	500	17	22	32	33	35	4900	0.50	200
CMCC0603C7N5◇SP	7.5	13	500	16	21	31	33	34	4700	0.50	200
CMCC0603C8N2◇SP	8.2	13	500	16	21	31	32	34	4300	0.56	190
CMCC0603C9N1◇SP	9.1	13	500	16	20	30	31	32	4100	0.72	170
CMCC0603C10N◇SP	10	13	500	16	20	28	29	31	3800	0.80	160
CMCC0603C12N◇SP	12	13	500	16	20	27	28	28	3400	0.80	160
CMCC0603C15N◇SP	15	13	500	15	19	24	24	23	2600	0.85	160
CMCC0603C18N◇SP	18	13	500	15	19	23	24	22	2300	1.00	140

◆ Specifications

Part Number	Inductance (nH)	Min. Quality Factor (Q)	L, Q Test Freq. L/Q(MHz)	Typical Q @ Freq. (GHz)					Min. Self-resonant Frequency (MHz)	Max. DC Resistance (Ω)	Max. Rated Current (mA)
				0.5	0.8	1.8	2.0	2.4			
				Q							
<b>CMCC0603 Series</b>											
CMCC0603C22N◇SP	22	13	500	15	19	22	23	20	1900	1.20	130
CMCC0603C27N◇SP	27	13	500	15	19	15	13	8	1800	1.60	120
CMCC0603C33N◇SP	33	11	300	14	15	8	5	-	1800	2.20	110
CMCC0603C39N◇SP	39	11	300	14	15	6	-	-	1600	2.30	100
CMCC0603C47N◇SP	47	11	300	14	15	-	-	-	1500	2.60	100
CMCC0603C56N◇SP	56	11	300	13	13	-	-	-	1400	2.80	80
CMCC0603C68N◇SP	68	11	300	13	11	-	-	-	1200	3.20	80
CMCC0603C82N◇SP	82	10	300	12	10	-	-	-	1100	3.80	70
CMCC0603CR10◇SP	100	10	300	12	10	-	-	-	1000	4.00	60
CMCC0603CR12◇SP	120	9	300	12	8	-	-	-	1000	5.00	50

Note: ◇: Please specify the inductance tolerance. For L≤6.2nH, choose B=±0.1nH, C=±0.2nH or S=±0.3nH; For L>6.2nH, choose G=±2%, H=±3% or J=5%.

◆ General Technical Data

Operating Temperature Range	-55°C ~ +125°C
Storage Condition	Less than 40°C and 70% RH
Soldering Method	Reflow or Wave Soldering

◆ **Composition / Information on Ingredients**

Product Structure: See Fig.1, Fig. 2 and Fig. 3



**Fig.1 Shape**

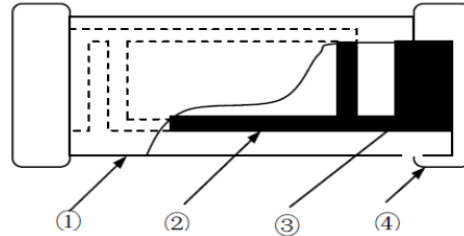

**Fig.2 Body Structure**

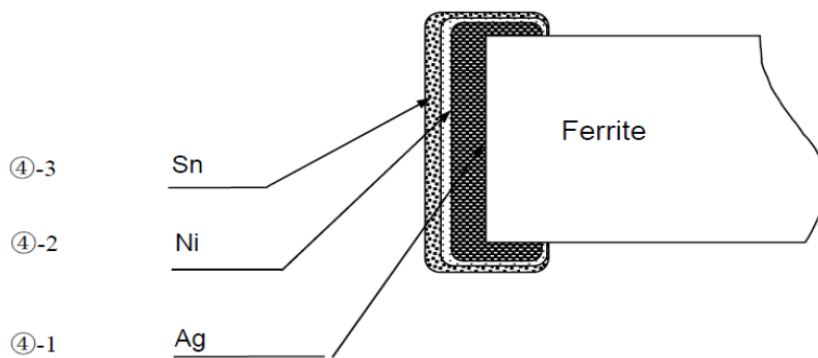

**Fig. 3 Structure of Electro-plating**

Composition/Information on the Components		
Code	Material	Main Components
①	Ceramic	Boron Silicate, Al <sub>2</sub> O <sub>3</sub> , Secret
②	Inner Coil	Silver (Ag)
③	Pull-out Electrode	Silver (Ag)
④-1	Terminal Electrode	Silver (Ag)
④-2	Electrode-plating: Nickel plating	Nickel (Ni)
④-3	Electrode-plating: Sn plating	Tin (Sn)

  

Compositions Wt Rate (Wt%) of Material		
Material	Wt Rate (Wt%)	CAS No.
Boron Silicate	51~65	65997-18-4
Al <sub>2</sub> O <sub>3</sub>	14~17	1344-28-1
Secret	0~5	-
Ag	9~29	7440-22-4
Nickel	1.8~2.3	7440-02-0
Tin	3.6~4.7	7440-31-5

◆ TYPICAL ELECTRICAL CHARACTERISTICS

### CMCC0603 Series

Inductance vs. Frequency Characteristics

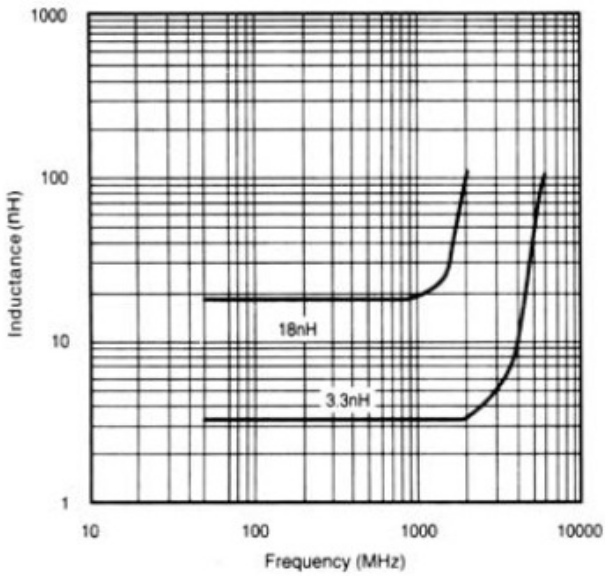

Impedance vs. Frequency Characteristics

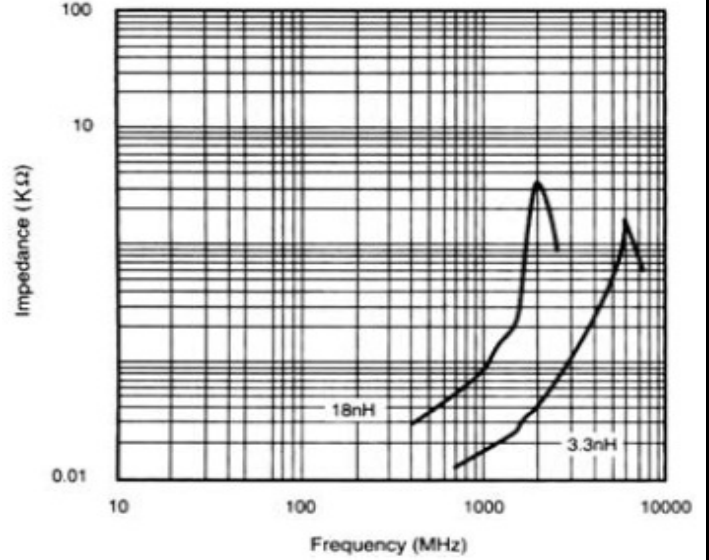

Q vs. Frequency Characteristics

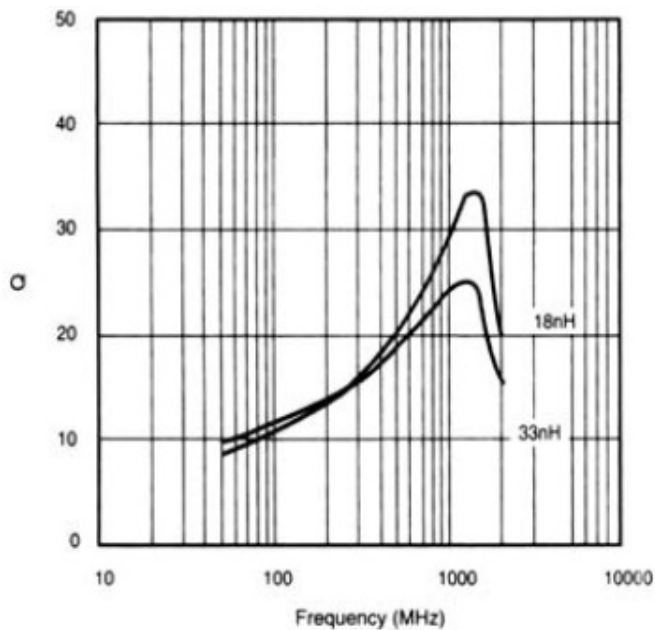

### ◆ Packaging

(1) Taping Drawings (Unit: mm)

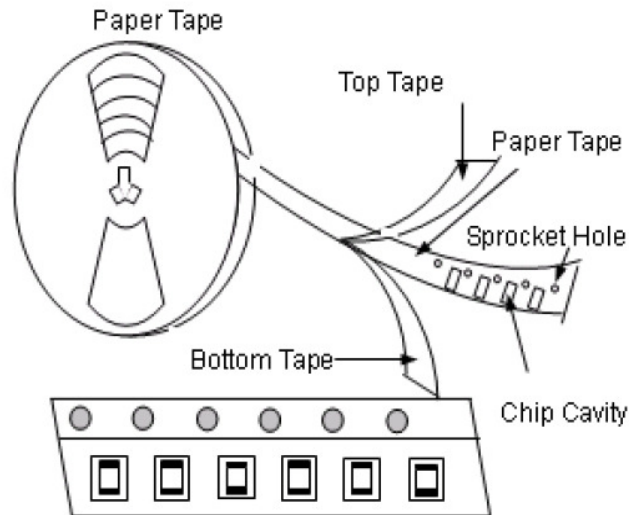

**Remark:** The sprocket holes are to the right as the tape is pulled toward the user.

(2) Taping Dimensions (Unit: mm)

Sprocket Hole  $\Phi 1.5 (+0.1, 0)$

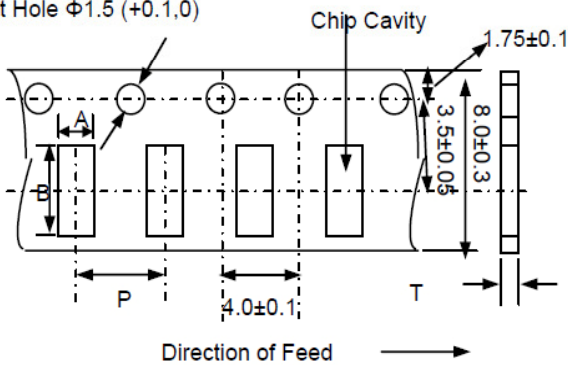

Paper Tape

Type	A	B	P	T max	Quantity
0603(0201)	0.4±0.1	0.7±0.1	2.0±0.05	0.55	15K

(3) Reel Dimensions (Unit: mm)

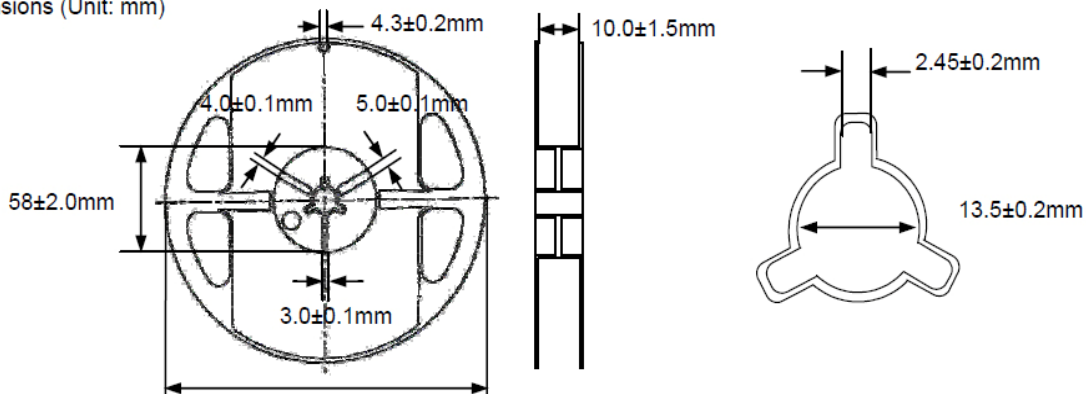

## X-ON Electronics

Largest Supplier of Electrical and Electronic Components

*Click to view similar products for [Fixed Inductors](#) category:*

*Click to view products by [Cybermax](#) manufacturer:*

Other Similar products are found below :

[MLZ1608M6R8WTD25](#) [MLZ1608N6R8LT000](#) [MLZ1608N3R3LTD25](#) [MLZ1608N3R3LT000](#) [MLZ1608N150LT000](#)  
[MLZ1608M150WTD25](#) [MLZ1608M3R3WTD25](#) [MLZ1608M3R3WT000](#) [MLZ1608M150WT000](#) [MLZ1608A1R5WT000](#)  
[MLZ1608N1R5LT000](#) [B82432C1333K000](#) [PCMB053T-1R0MS](#) [PCMB053T-1R5MS](#) [PCMB104T-1R5MS](#) [CR32NP-100KC](#) [CR32NP-151KC](#) [CR32NP-180KC](#) [CR32NP-181KC](#) [CR32NP-1R5MC](#) [CR32NP-390KC](#) [CR32NP-3R9MC](#) [CR32NP-680KC](#) [CR32NP-820KC](#)  
[CR32NP-8R2MC](#) [CR43NP-390KC](#) [CR43NP-560KC](#) [CR43NP-680KC](#) [CR54NP-181KC](#) [CR54NP-470LC](#) [CR54NP-820KC](#) [CR54NP-8R5MC](#)  
[MGDQ4-00004-P](#) [MGDU1-00016-P](#) [MHL1ECTTP18NJ](#) [MHL1JCTTD12NJ](#) [PE-51506NL](#) [PE-53601NL](#) [PE-53630NL](#) [PE-53824SNLT](#) [PE-62892NL](#) [PE-92100NL](#) [PG0434.801NLT](#) [PG0936.113NLT](#) [PM06-2N7](#) [PM06-39NJ](#) [HC2LP-R47-R](#) [HC2-R47-R](#) [HC3-2R2-R](#) [HC8-1R2-R](#)