



承认书

SPECIFICATION FOR APPROVAL

CUSTOMER:			
CUSTOMER P/N:			
Cybermax P/N:	CMCW2012F220KTT		
DRAWN NO. :	CM190705001		
DATE:	19.07.05	REVISION NO.	A

Signature:

APPROVED BY	CHECKED BY	DRAWN BY
 <p>黄 19.07.05 大燕</p>	 <p>谢 19.07.05 焕飞</p>	 <p>申 19.07.05 双凤</p>



CUSTOMER:		PAGE:	1/10
CUSTOMER P/N:		REVISION:	
Cybermax P/N:	CMCW2012F220KTT	DATE:	19.07.05
DRAWN NO.:	CM190705001		

SHAPE & DIMENSION (UNIT:mm)	
Marking Code:	Size: Color: typeface:
PAD LAYOUT(MM):	ELECREICAL SCHEMATIC:

ELECREICAL SPECIFICATION						
MEAS. ITEM	SPEC.				TEST FREQ.	CONDITIONS
L	22	μH	±	10%	2.5MHz/0.1V	Ta=25°C , Idc=0A
DCR	1.76	Ω	±	30%		Ta=25°C
Isat	0.24AMAX(0.3ATYP)				2.5MHz/0.1V	ΔL/L≤30%
Irms	0.34AMAX(0.45ATYP)				2.5MHz/0.1V	ΔT≤40°C
GENERAL SPECIFICATION						
Electrical specifications :			at 25°C			
Operation Temperature:			-40~+125°C			
Storage Temperature:			-40~+125°C			
(1)WIRE TYPE: ϕ 0.05mm						
(2)WINDING:61.5Ts(Ref.)						

CUSTOMER:		PAGE:	2/10
CUSTOMER P/N:		REVISION:	
Cybermax P/N:	CMCW2012F220KTT	DATE:	19.07.05
DRAWN NO.:	CM190705001		

Reliability Test			
No.	Item	Specification	Test Method
1	Temperature Shock.	Appearance: No damage. Inductance: within $\pm 10\%$ of initial.	Temperature: $-25\pm 2^{\circ}\text{C} \sim +105\pm 2^{\circ}\text{C}$ Kept for 30 minutes. Transition time : 5 minutes. 100 Cycles.
2	Humidity Resistance.	Appearance: No damage. Inductance: within $\pm 10\%$ of initial.	Temperature: $40\pm 2^{\circ}\text{C}$. Relative Humidity: 90%. Duration: 500 +4/-0 hours.
3	High Temperature Resistance.	Appearance: No damage. Inductance: within $\pm 10\%$ of initial.	Temperature: $105\pm 2^{\circ}\text{C}$. Duration: 1000 +4/-0 hours.
4	Low Temperature Resistance.	Appearance: No damage. Inductance: within $\pm 10\%$ of initial.	Temperature: $-25\pm 2^{\circ}\text{C}$. Duration: 1000 +4/-0 hours.
5	Vibration test.	Appearance: No damage. Inductance: within $\pm 10\%$ of initial.	Oscillation Frequency: 10Hz to 55Hz to 10Hz in 60 seconds as a period. Total amplitude: 1.5mm. Testing Time: a period of 2 hours in each 3 mutually perpendicular directions (total of 6 hours).
6	Solderability Heat test.	Appearance: No damage. Inductance: within $\pm 10\%$ of initial.	Solder temperature: $260 +0/-5^{\circ}\text{C}$. Duration: 5 sec. Allowed reflow time: 2 times.
7	Solderability test.	90% or more of electrode area shall be coated by new solder.	Preheating: 160°C , 60sec. Solder temperature: $245\pm 5^{\circ}\text{C}$. Duration : 5 sec.
8	Flexure Strength.	No visible mechanical damage.	Flexure: 2mm. Pressurizing Speed: 0.5mm/sec. Keep time: 30 ± 1 sec.
9	Terminal Strength.	No visible mechanical damage.	Force: 0.45Kg for 0603 series. Force: 0.9Kg for 0805 series. Force: 1.8Kg for 1008 series above. Keep time: 5 sec, X, Y directs.

CUSTOMER:		PAGE:	4/10
CUSTOMER P/N:		REVISION:	
Cybermax P/N:	CMCW2012F220KTT	DATE:	19.07.05
DRAWN NO.:	CM190705001		

SOLDERING CONDITIONS

**Figure 1.
Re-flow
Soldering (Lead
Free)**

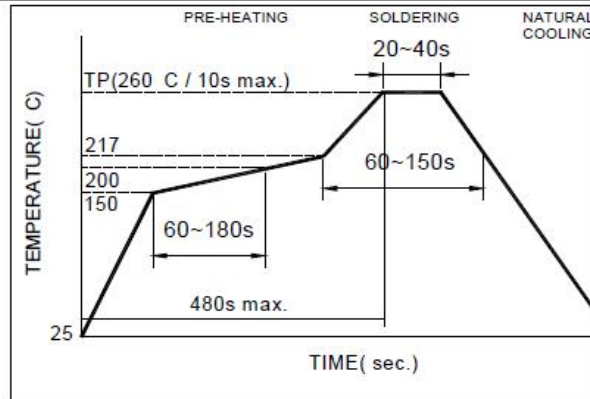

Note:

- Preheat circuit and products to 150°C
- 260°C tip temperature (max)

**Figure 2.
Wave Soldering**

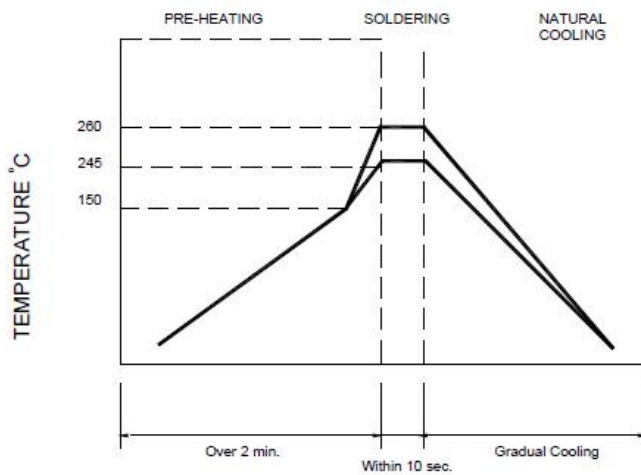

Note :

- Never contact the ceramic with the iron tip
- 1.0mm tip diameter (max)

**Figure 3.
Hand Soldering**

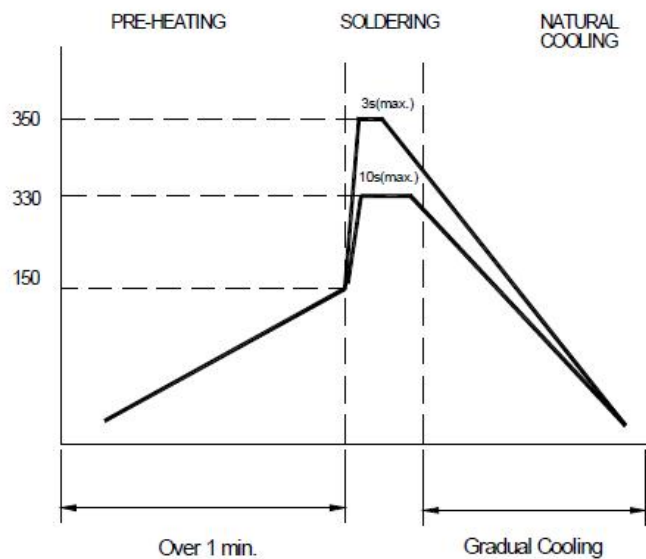

Note:

- Use a 20 watt soldering iron with tip diameter of 1.0mm
- Limit soldering time to 3 sec.

CUSTOMER:		PAGE:	5/10
CUSTOMER P/N:		REVISION:	
Cybermax P/N:	CMCW2012F220KTT	DATE:	19.07.05
DRAWN NO.:	CM190705001		

B.O.M

项目名称	型号及规格	制造商	环保要求	备注
磁芯 (DRUM CORE)	MF401 SWI2012C075-LS	台湾佳叶/台湾光绅	RoHS	主选
线材 (WIRE)	P180G1-0.05mm	益利素勒	RoHS	主选
胶水 (GLUE)	UW-523	贺盛	RoHS	灌封

CUSTOMER:		PAGE:	6/10
CUSTOMER P/N:		REVISION:	
Cybermax P/N:	CMCW2012F220KTT	DATE:	19.07.05
DRAWN NO.:	CM190705001		

Isat(飽和電流):電感瞬間的突波電流

CMCW2012F220KTT

TME(秒)	Lsat(A)	L(UH)	$\Delta L/L(\%)$
1	0.000	22.60	0.00%
1	0.034	22.60	0.00%
1	0.068	22.60	0.00%
1	0.102	22.50	-0.44%
1	0.136	22.40	-0.88%
1	0.170	22.10	-2.21%
1	0.204	21.50	-4.87%
1	0.238	20.50	-9.29%
1	0.272	19.40	-14.16%
1	0.306	16.90	-25.22%
1	0.340	12.80	-43.36%

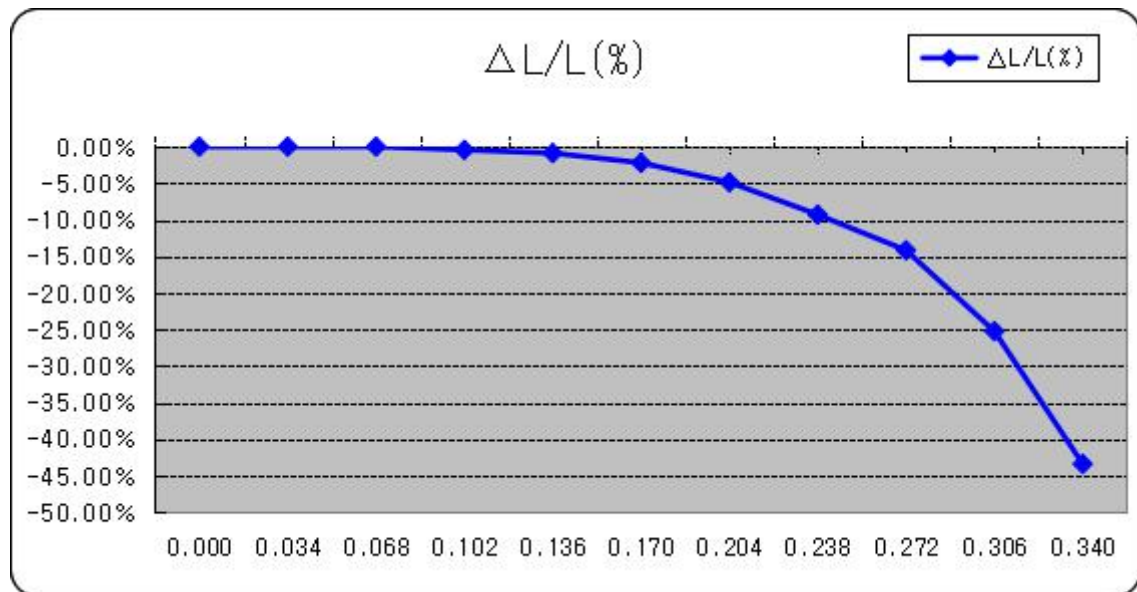

CUSTOMER:		PAGE:	7/10
CUSTOMER P/N:		REVISION:	
Cybermax P/N:	CMCW2012F220KTT	DATE:	19.07.05
DRAWN NO.:	CM190705001		

單點溫昇

CMCW2012F220KTT

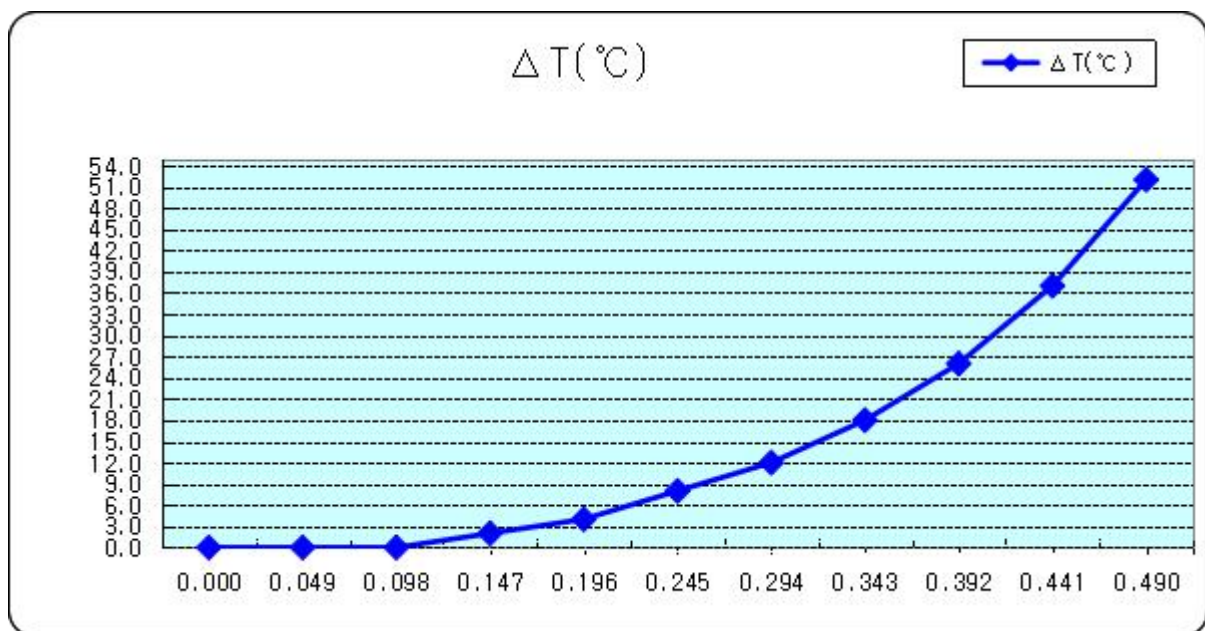

TIME(S)	Irms(A)	L(uH)	$\Delta L/L(\%)$	Temp($^{\circ}C$)	$\Delta T(^{\circ}C)$
30	0.000	22.80	0.00%	31.0	0.0
30	0.049	22.60	-0.88%	31.0	0.0
30	0.098	22.30	-2.19%	31.0	0.0
30	0.147	21.90	-3.95%	33.0	2.0
30	0.196	21.50	-5.70%	35.0	4.0
30	0.245	19.80	-13.16%	39.0	8.0
30	0.294	15.70	-31.14%	43.0	12.0
30	0.343	9.05	-60.31%	49.0	18.0
30	0.392	4.96	-78.25%	57.0	26.0
30	0.441	3.54	-84.47%	68.0	37.0
30	0.490	3.13	-86.27%	83.0	52.0

※DC bias current characteristics in the ambient temperature 25 $^{\circ}C$ Frequency 2.5MHz/0.1V



CUSTOMER:		PAGE:	8/10
CUSTOMER P/N:		REVISION:	
Cybermax P/N:	CMCW2012F220KTT	DATE:	19.07.05
DRAWN NO.:	CM190705001		

TEST DATA FOR PREPRODUCTION SAMPLE							
TEST RESOLUTION					DIMENSION (Unit: mm)		
MEAS.	L	D.C.R			长	宽	高
ITEM	μH	Ω			mm	mm	mm
SPEC.	22	1.76			Max.2.4	Max.1.73	1.3±0.1
	±	±					
TEST FREQ.	10%	30%					
	2.5MHz/0.1V		Isat 0.24A	ΔL/L ≤ 30%			
1	22.6	1.98	20.5	-9.3%	2.22	1.63	1.28
2	23.2	1.98	21.2	-8.6%	2.23	1.69	1.29
3	22.9	1.98	20.5	-10.5%	2.27	1.68	1.31
4	22.8	1.97	20.3	-11.0%	2.24	1.64	1.29
5	23.3	1.98	21.5	-7.7%	2.28	1.62	1.24
6	22.8	1.98	21.0	-7.9%			
7	22.7	2.00	20.5	-9.7%			
8	22.6	1.99	20.3	-10.2%			
9	21.8	1.98	20.0	-8.3%			
10	22.0	2.00	20.3	-7.7%			
AVG.	22.670	2.0	20.610	-9.08%			
R	1.5	0.03	1.60	-4.20%			

APPROVED BY	CHECKED BY	DRAWN BY
		

CUSTOMER:		PAGE:	9/10
CUSTOMER P/N:		REVISION:	
Cybermax P/N:	CMCW2012F220KTT	DATE:	19.07.05
DRAWN NO.:	CM190705001		

PACKAGING

热封包装

Reel dimensions

UNIT : mm

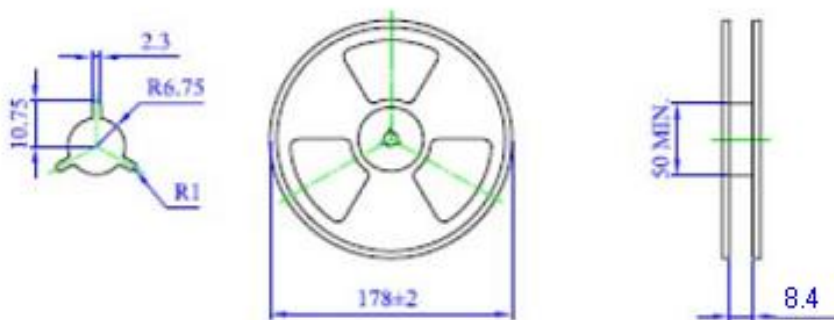

Tape dimensions

UNIT : mm
TOLERANCE : ±0.1

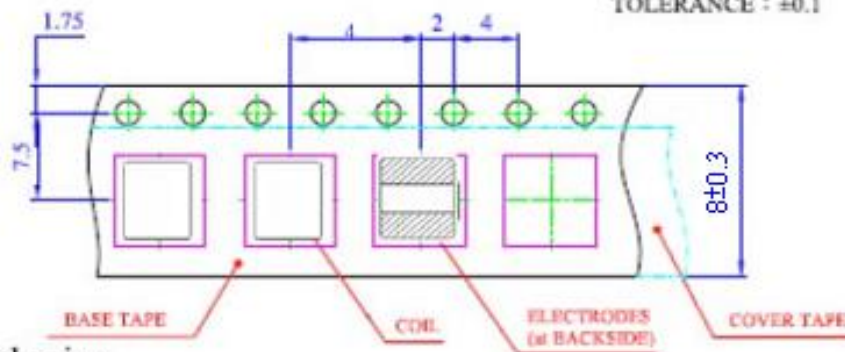

Packaging

Quantity : **2000** pcs/reel

CUSTOMER:		PAGE:	10/10
CUSTOMER P/N:		REVISION:	
Cybermax P/N:	CMCW2012F220KTT	DATE:	19.07.05
DRAWN NO.:	CM190705001		

PACKAGING

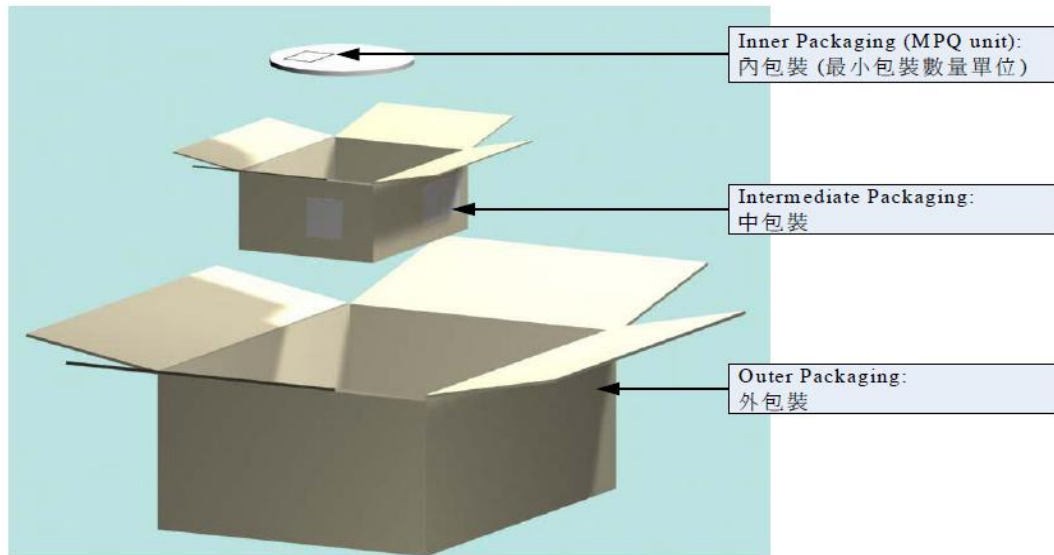

- 1.1 外箱: 39*38*18.5 cm 一箱裝 8 內箱
 - 1.2 內箱: 18.7*18.4*8.3 cm 一箱裝 5 卷制品
 - 1.3 外箱材質: A 三 A
 - 1.4 內箱材質: A=A
 - 1.5 每 5 卷制品用一只静电袋包裝
 - 1.6 每一静电袋內放一只袋干燥剂
 - 1.7 每一卷上面依标签样式的要求贴上标签明細
 - 1.8 出货內外箱贴上該箱內实际內容明細
 - 1.9 出货标签规格如下: 尺寸=长度:39mm 宽度:29mm
- (如: 客戶有特殊要求時, 則依客戶要求實施.)



备注: 如果捆包数量小于內箱捆包数量时就用內箱包裝

X-ON Electronics

Largest Supplier of Electrical and Electronic Components

Click to view similar products for [cybermax](#) manufacturer:

Other Similar products are found below :

[CMLH0704S100MTT](#) [CMLW252012SR47MST](#) [CMLF0504-1R0MTT](#) [CMLF0705-8R2MTT](#) [CMLO0630H1R5MTT](#) [CMLH1207S470MTT](#)
[CMLW4010S100MST](#) [CMLW5012S100MST](#) [CMLH0704S6R8MTT](#) [CMLH1207S100MTT](#) [CMLW4030S2R2MST](#) [CMLO0630H4R7MTT](#)
[CMLW252012S2R2MST](#) [CMLW252012S6R8MST](#) [CMBH3216S102LSP](#) [CMCW2012F2R2KTT](#) [CMCC1608C6N2SSP](#)
[CMLW6045S220MST](#) [CMLH1207S471MTT](#) [CMLH0704S150MTT](#) [CMLH1207S330MTT](#) [CMLF0705-470KTT](#) [CMLW6028S2R2NST](#)
[CMLH0704S471MTT](#) [CMLW252010S1R0MST](#) [CMLO0650H1R5MTT](#) [CMLW5020S100MST](#) [CMLH1207S151MTT](#) [CMLH1207S221MTT](#)
[CMLH1207S150MTT](#) [CMLF0403-221KTT](#) [CMLO1040H2R2MTT](#) [CMLO1040H220MTT](#) [CMLW4010S6R8MST](#) [CMLF0504-471KTT](#)
[CMLO0650H2R2MTT](#) [CMCW2012F220KTT](#) [CMLO0650H470MTT](#) [CMLF0705-220KTT](#) [CMLW6028S330MST](#) [CMLF0705-680KTT](#)
[CMLW3012S4R7MST](#) [CMLW8040S100MST](#) [CMLO0650H4R7MTT](#) [CMLO0630H150MTT](#) [CMLF0504-101KTT](#) [CMLW4030S4R7MST](#)
[CMLW4012P4R7MST](#) [CMLW8040S2R2NST](#) [CMLF0705-3R3MTT](#)