

◆ **Scope**

This specification applies to the CMLO201610T Series of SMD power inductors.

◆ **Lead Free PartNumbering**

| CMLO | 201610 | T | 1R0 | M | T | T |
|------|--------|-----|-----|-----|-----|-----|
| (1) | (2) | (3) | (4) | (5) | (6) | (7) |

- (1) Series Type
- (2) Dimension: LxWxH
- (3) Material Code
- (4) Inductance:R68=0.68uH;1R0=1.0μH
- (5) Inductance Tolerance:M=±20%,N=±30%
- (6) Company Code
- (7) Packaging: packed in embossed carrier tape

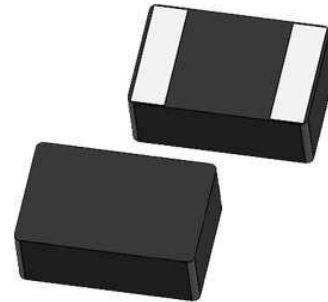

◆ **Dimensions**

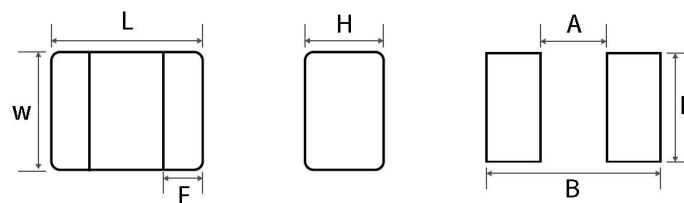

| Series | L(mm) | W(mm) | H(mm) | F(mm) | Recommended Land Patterns | | |
|-------------|---------|---------|---------|---------|---------------------------|---------|---------|
| | | | | | A(mm) | B(mm) | E(mm) |
| CMLO201610T | 2.0±0.2 | 1.6±0.2 | 1.0Max. | 0.5Typ. | 0.8Typ. | 2.1Typ. | 1.7Typ. |

◆ **Structural drawing**

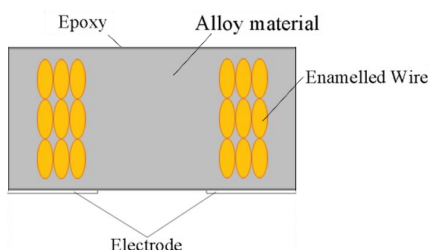

| No. | Component | Material |
|-----|-----------|-----------------|
| ① | Body | Alloy material |
| ② | Winding | Enamelled Wire |
| ③ | Shield | Epoxy |
| ④ | Electric | Base plating-Cu |
| | | Base plating-Ni |
| | | Base plating-Sn |

◆ **Specification**

| Part No. | Inductance Ls(uH) | Direct Current Resistance DCR(mΩ) | | Saturatio n Current Isat(A) | Temperature Rise Current Irms(A) |
|-------------------|----------------------|---|-----------|--------------------------------------|--|
| CMLO201610TR24MTT | 0.24±20% | 17.0 Max | 14.0 Typ | 7.80 Max | 5.60 Max |
| CMLO201610TR33MTT | 0.33±20% | 22.0 Max | 17.0 Typ | 6.50 Max | 5.30 Max |
| CMLO201610TR47MTT | 0.47±20% | 25.0 Max | 22.0 Typ | 5.50 Max | 5.00 Max |
| CMLO201610TR68MTT | 0.68±20% | 32.0 Max | 25.0 Typ | 4.70 Max | 4.30 Max |
| CMLO201610T1R0MTT | 1.0±20% | 43.0 Max | 35.0 Typ | 4.20 Max | 4.10 Max |
| CMLO201610T1R5MTT | 1.5±20% | 100.0 Max | 80.0 Typ | 2.90 Max | 2.30 Max |
| CMLO201610T2R2MTT | 2.2±20% | 130.0 Max | 120.0 Typ | 2.80 Max | 2.10 Max |
| CMLO201610T3R3MTT | 3.3±20% | 170.0 Max | 140.0 Typ | 2.00 Max | 1.50 Max |
| CMLO201610T4R7MTT | 4.7±20% | 220.0 Max | 190.0 Typ | 1.80 Max | 1.40 Max |

Test condition & equipment :

| Item | Test condition | Test equipment |
|------|--------------------------|------------------------------------|
| Ls | 1MHz/1V | HP4263BIM3532-50 or equivalent |
| DCR | direct-current | HP4263BRM3545 or equivalent |
| Isat | 1MH/1V | Microtest 6379 &6220 or equivalent |
| Irms | ambient temperature 20°C | Microtest 6379 &6220 or equivalent |

◆ **Operating Temperature Range**

-40°C ~ +125°C, Including self-heating

◆ **Storage Conditions**

Store products in a warehouse in compliance with the following condition:

Temperature: Inductors (product with taping) -10 to +40°C;

Inductors body -40 to +85°C.

Humidity: 30~70%RH

◆ **RECOMMENDED REFLOW PROFILE**

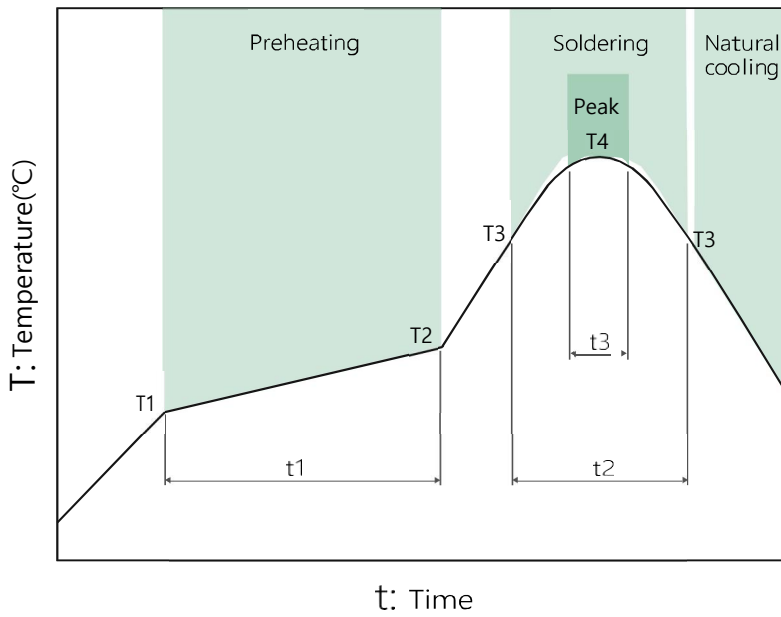

| Preheating | | | Soldering | | Peak | |
|------------|-------|------------|-----------|-----------|--------------|---------|
| Temp. | Time | | Temp. | Time | Temp. | Time |
| T1 | T2 | t1 | T3 | t2 | T4 | t3 |
| 150°C | 180°C | 60 to 120s | 230°C | 30 to 50s | 250 to 260°C | 10s max |

◆ **Reliability Mechanical**

| 序号 No. | 项目 Items | 要求 Requirements | 试验方法及备注 Test Methods and Remarks |
|-----------|--|--|--|
| 1 | 绝缘电阻 Insulation Resistance | $\geq 100M\Omega$ | 在电感器线圈和本体顶面中间施加 100 V 直流电压保持60 s。 100 V DC between inductor coil and The middle of the top surface of the body for 60 seconds. |
| 2 | 可焊性 Solderability | 电极面90%以上覆盖新的焊料。 90% or more of electrode area shall be coated by new solder. | 在(245±5) °C熔融的焊锡 (96.5Sn/3.0Ag/0.5Cu) 中浸(5±1)s。 Dip pads in flux and dip in solder pot (96.5Sn/3.0Ag/0.5Cu) at (245±5) °C for (5±1) seconds. |
| 3 | 耐焊接热 Resistance to Soldering Heat | 外观无可见机械损伤； 电感量变化率：±10%以内。 No visible mechanical damage, Inductance change: Within ±10% | 在(260±5) °C熔融的焊锡 (96.5Sn/3.0Ag/0.5Cu) 中浸(10±1) s。 Dip pads in flux and dip in solder pot (96.5Sn/3.0Ag/0.5Cu) at (260±5) °C for (10±1) seconds. |
| 4 | 端子强度 Adhesion of terminal electrode | 元件的端子与本体结合无松动、无脱落。 Strong bond between the pad and the core, without come off PC board. | 将电感器用(260±5)°C，(20±5)s 焊在带有 0.3 mm厚锡膏的基板上，然后用治具垂直电极面方向加压 10 N，(10±1) s。 Inductors shall be subjected to (260±5)°C for (20±5) s Soldering in the base whit 0.3mm solder. And then aplomb electrode way plus tax 10 N for (10±1) seconds. |
| 5 | 耐高温 High temperature | 外观无可见机械损伤； 电感量变化率：±10%以内。 No visible mechanical damage. Inductance change: Within ±10% | 温度(+85 ± 2)°C,时间(96±2) h; Temperature is (+85±2)°C and keep (96±2) hours. |
| 6 | 耐低温 Low temperature | 外观无可见机械损伤； 电感量变化率：±10%以内。 No visible mechanical damage. Inductance change: Within ±10% | 温度(-40°C ±2) °C，时间(96±2)h; Temperature is (-40±2)°C and keep (96±2) hours. |

| 序号 No. | 项目 Items | 要求 Requirements | 试验方法及备注 Test Methods and Remarks |
|-----------|------------------------------------|---|--|
| 7 | 温度变化 Thermal shock | 外观无可见机械损伤；电感量变化率：±10%以内。 No visible mechanical damage. Inductance change: Within ±10% | (-40±3) °C,时间(30±3) min ↔ (125°C±2) °C/(30±3) min, 转换时间(2~3) min,循环32次； 在室温下放置 2 小时后、48 小时内测试。 The test sample shall be placed at (-40±3)°C and (125±2)°C for (30±3)min, different temperature conversion time is 2~3 minutes. The temperature cycle shall be repeated 32 cycles. Placed at room temperature for 2 hours, within 48 hours of testing. |
| 8 | 温度特性 Temperature characteristic | 电感量变化率 P_{c-b}, P_{c-d} 不超过±20%。 Inductance change P_{c-b}, P_{c-d} : Within ±20% | a: +20 °C (30~45) min → b: -40 °C (30~45) min → c: +20 °C (30~45) min → d: +125 °C (30~45) min → e: +20 °C (30~45) min $P_{c-b} = \frac{L_b - L_c}{L_c} \times 100\%$; $P_{c-d} = \frac{L_d - L_c}{L_c} \times 100\%$ |
| 9 | 恒定湿热 Static Humidity | 外观无可见机械损伤； 电感量变化率：±10%以内。 No visible mechanical damage. Inductance change: Within ±10% | 将电感器放置在于湿度(93±3)%RH,温度(40±2) °C 的环境中存放(1000±2)h, 在室温下放置2 小时后、48 小时内测试。 Inductors shall be subjected to (93±3)%RH . at (60±2)°C for (96±2) h . Placed at room temperature for 2 hours, within 48 hours of testing. |
| 10 | 耐久性 (寿命) Life | 外观无可见机械损伤； 电感量变化率：±10%以内。 No visible mechanical damage. Inductance change: Within ±10% | 温度(85±2)°C, 时间(1000±24)h,施加Irms, 在室温下放置2 小时后、48 小时内测试。 Inductors shall be store at (85±2)°C for (1000±24) hours with Irms applied. Placed at room temperature for 2 hours, within 48 hours of testing. |

◆ **Taping reel dimensions**

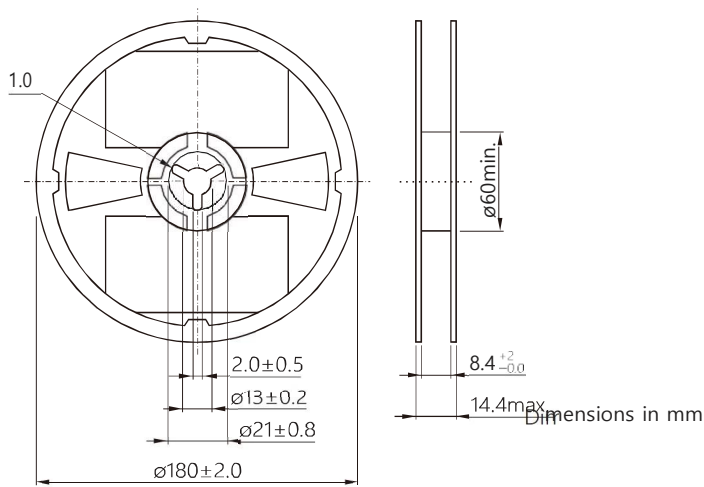

◆ **Carrier tape dimensions**

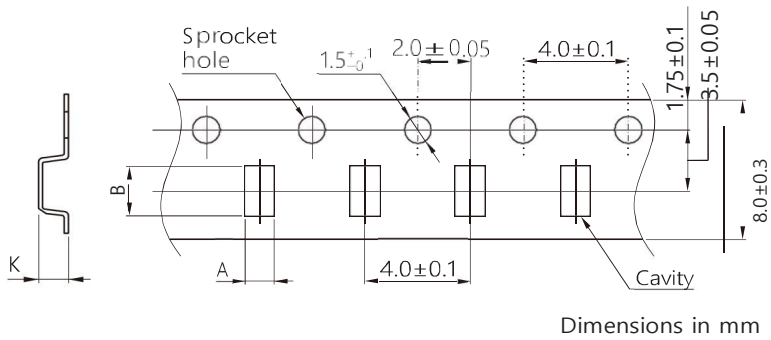

| Series Type | A | R | K |
|-------------|-----|-----|-----|
| CMLO201610T | 2.2 | 2.7 | 1.3 |

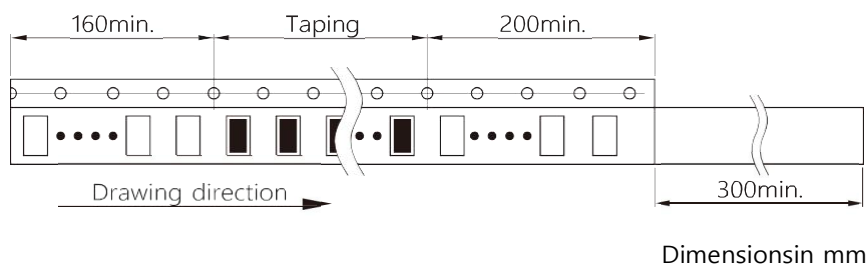

◆ **Package quantity**

| | |
|------------------|---------------|
| Package quantity | 3000 pcs/reel |
|------------------|---------------|

X-ON Electronics

Largest Supplier of Electrical and Electronic Components

Click to view similar products for [Fixed Inductors](#) category:

Click to view products by [Cybermax](#) manufacturer:

Other Similar products are found below :

[CR43NP-680KC](#) [CR54NP-470LC](#) [CR54NP-820KC](#) [CR54NP-8R5MC](#) [70F224AI](#) [MGDQ4-00004-P](#) [MHL1ECTTP18NJ](#) [MHQ1005P10NJ](#)
[MHQ1005P1N0S](#) [MHQ1005P2N4S](#) [MHQ1005P3N6S](#) [MHQ1005P5N1S](#) [MHQ1005P8N2J](#) [PE-51506NL](#) [PE-53601NL](#) [PE-53602NL](#) [PE-53630NL](#) [PE-53824SNLT](#) [PE-92100NL](#) [PG0434.801NLT](#) [PG0936.113NLT](#) [9220-20](#) [9310-16](#) [PM06-2N7](#) [PM06-39NJ](#) [A01TK](#) [1206CS-471XJ](#) [HC2LP-R47-R](#) [HC2-R47-R](#) [HC3-2R2-R](#) [HC3-R50-R](#) [HC8-1R2-R](#) [HCF1305-3R3-R](#) [1206CS-151XG](#) [RCH664NP-140L](#) [RCH664NP-4R7M](#) [RCH8011NP-221L](#) [RCP1317NP-332L](#) [RCP1317NP-391L](#) [RCR1010NP-470M](#) [RCR110DNP-331L](#) [DH2280-4R7M](#) [DS1608C-106](#)
[ASPI-4020HI-R10M-T](#) [B10TJ](#) [B82498B3680J000](#) [ELJ-RE27NJF2](#) [1812CS-153XJ](#) [1812CS-183XJ](#) [1812CS-223XJ](#)