

PCSB25201T-XXXMS Sealed Choke Coil

1. Features

Low profile : 2.5mm x 2.0mm x 1.0mm

High performance (Isat) realized by metal dust core.

Low loss realized with low DCR

High magnetic shield construction should actualize high resolution for EMC protection.

100% lead (Pb) free meet RoHS standard

2. Application

DC/DC converter for CPU in Notebook PC

Cellular phones, LCD displays, HDDs, DVCs, DSCs, PDAs etc..

Thin type on-board power supply module for exchanger

VRM for server

3. Type Designation

PCSB 25201T – XXX M S
 (1) (2) (3) (4) (5)

- Where
- (1) Series No :
 - (2) Size :
25201T = 2.5mm x 2.0mm x 1.0mm
 - (3) Inductance Value :
1R0 = 1.0μH
 - (4) Tolerance :
M = ± 20%
 - (5) Materials :
S = S type

4. Outline Dimensions

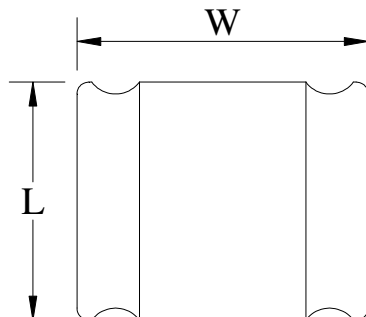

Code	Dimensions (mm)
L	2.0 ± 0.2
W	2.5 ± 0.2
T	1.0 max.

Unit : mm

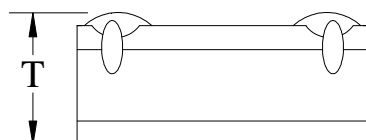

Note : This graph is in regard to outline dimensions spec. For outer appearance, please refer to actual product.

5. Recommend Land Pattern Dimensions

The customer shall determine the land dimensions shown below after confirming and safety.

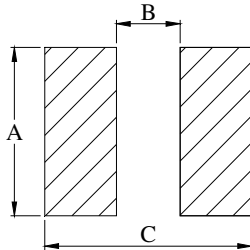

A	2.1
B	0.8
C	2.6

Unit : mm

6. Specifications

Part Number	L0 Inductance (μH) @ (0A)	R_{dc} (m Ω)		Heat Rating Current DC Amps. Idc (A)		Saturation Current DC Amps. Isat (A)	
		Typical	Maximum	Typical	Maximum	Typical	Maximum
PCSB25201T-R47MS	0.47	29	35	3.9	3.51	4.70	4.20
PCSB25201T-R68MS	0.68	40	48	3.5	3.15	4.15	3.70
PCSB25201T-1R0MS	1.0	52	62	3.3	3.00	3.90	3.60
PCSB25201T-1R5MS	1.5	84	100	2.2	1.98	2.90	2.65
PCSB25201T-2R2MS	2.2	100	120	2.0	1.80	2.50	2.20
PCSB25201T-4R7MS	4.7	217	260	1.5	1.35	1.70	1.53
PCSB25201T-100MS	10.0	633	760	0.9	0.81	1.20	1.10

* : If you require another part number please contact with us.

** : Inductance Tolerance $\pm 20\%$

Note 1. : All test data is referenced to 25 $^{\circ}\text{C}$ ambient.

Note 2. : Idc : DC current (A) that will cause an approximate ΔT of 40 $^{\circ}\text{C}$

Note 3. : Isat : DC current (A) that will cause L0 to drop approximately 30%

Note 4. : Operating Temperature Range -55 $^{\circ}\text{C}$ to + 125 $^{\circ}\text{C}$

Note 5. : The part temperature (ambient + temp rise) should not exceed 125 $^{\circ}\text{C}$ under the worst case operating conditions. Circuit design , component placement, PCB trace size and thickness, airflow and other cooling provision all affect the part temperature. Part temperature should be verified in the end application.

Note 6. : The rated current as listed is either the saturation current or the heating current depending on which value is lower.

6-1 Current Characteristic

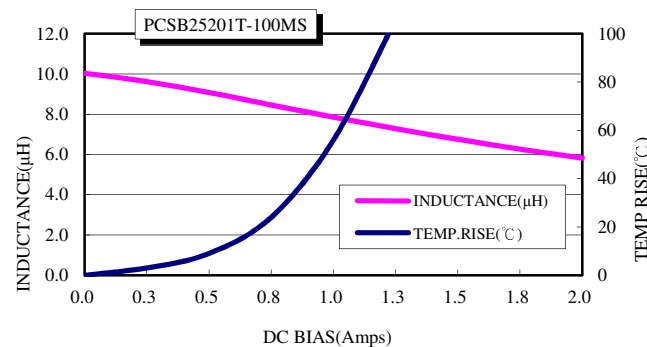
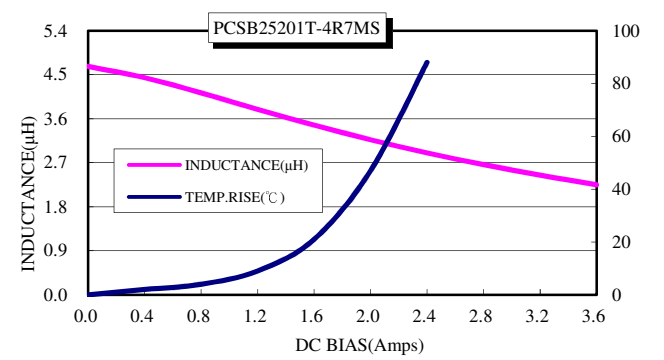
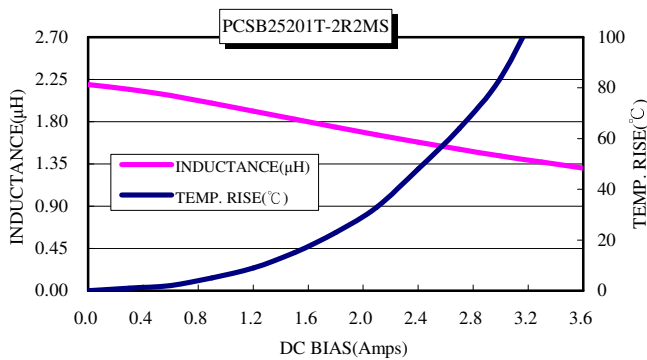
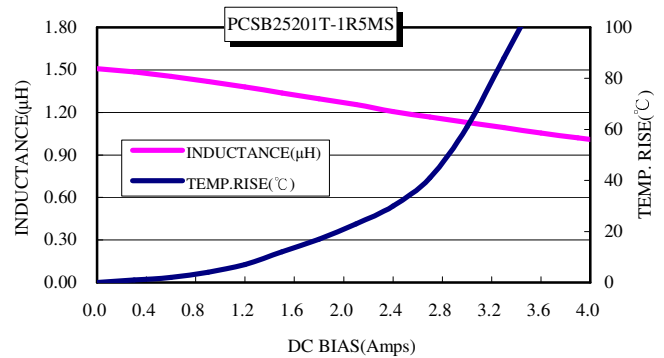
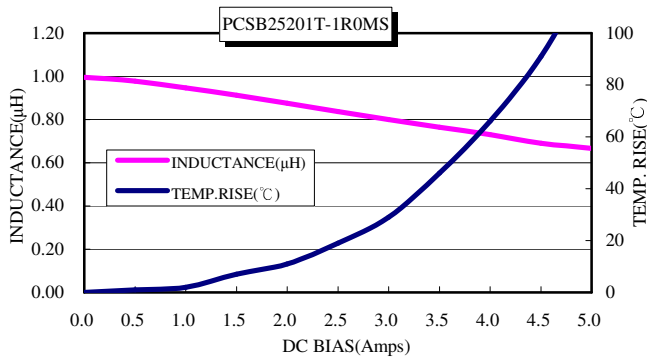
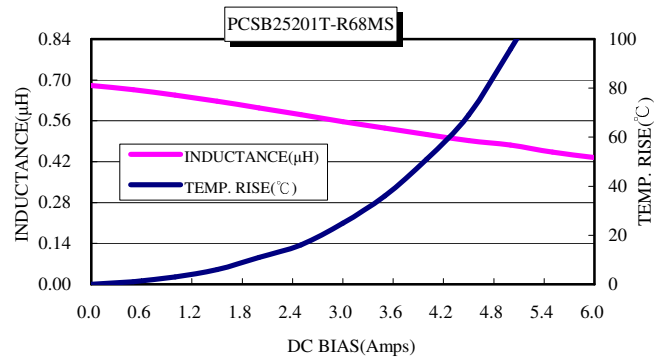
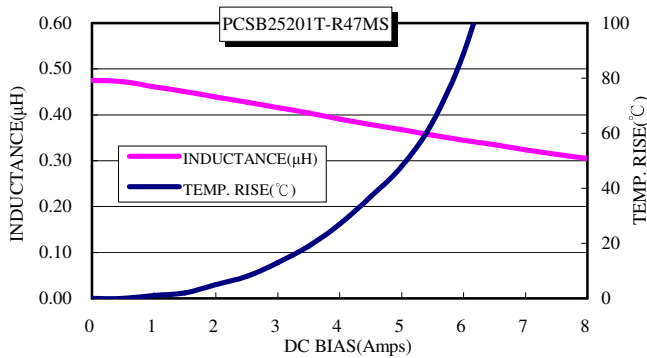

Test Instruments

Wayne kerr 3260B/G LCR Meter

Wayne kerr 3265B Bias Current Source

Test Condition

Temperature : $26 \pm 3^{\circ}\text{C}$, Humidity : $< 70\% \text{ RH}$

Frequency : 1MHz , 1.0V

7. Reliability

7-1 Mechanical

Item	Specification and Requirement	Test Method
Solderability	The surface of terminal immersed shall be minimum of 95% covered with a new coating of solder	Solder heat proof : (1) Preheating : $160 \pm 10^{\circ}\text{C}$ 90seconds (2) Retention time : $245 \pm 5^{\circ}\text{C}$ for 2 ± 0.5 seconds
Vibration	Inductance change : Within $\pm 10\%$ Without mechanical damage such as break	(1) Vibration frequency : (10Hz to 55Hz to 10Hz) in 60 seconds as a period (2) Vibration time : period cycled for 2 hours in each of 3 mutual perpendicular directions (3) Amplitude : 1.5mm _{max.}
Shock	Inductance change : Within $\pm 10\%$ Without mechanical damage such as break	(1) Peak value : 100G (2) Duration of pulse : 11ms (3) 3 times in each positive and negative direction of 3 mutual perpendicular directions

7-2 Endurance

Item	Specification and Requirement	Test Method
Thermal Shock	Inductance change : Within $\pm 10\%$ Without distinct damage in appearance	(1) Repeat 100 cycle as follow : (-55 $\pm 2^{\circ}\text{C}$, 30 ± 3 minutes) \rightarrow (Room temperature, 5 minutes) \rightarrow (+125 $\pm 2^{\circ}\text{C}$, 30 ± 3 minutes) \rightarrow (Room temperature, 5 minutes) (2) Recovery : 48 + 4 / - 0 hours of recovery under the standard condition after the test. (See Note1)
High Temperature resistance	Inductance change : Within $\pm 10\%$ Without distinct damage in appearance	(1) Environment condition : 85 $\pm 2^{\circ}\text{C}$ Applied Current : Rated current (2) Duration : 1,000 + 4 / - 0 hours (See Note1)
Humidity resistance	Inductance change : Within $\pm 10\%$ Without distinct damage in appearance	(1) Environment condition : 60 $\pm 2^{\circ}\text{C}$ Humidity : 90~95% Applied Current : Rated current (2) Duration : 1,000 + 4 / - 0 hours (See Note1)
Low Temperature Store	Inductance change : Within $\pm 10\%$ Without distinct damage in appearance	(1) Store temperature : -55 $\pm 2^{\circ}\text{C}$ for total 1,000 + 4 / - 0 hours
High Temperature Store	Inductance change : Within $\pm 10\%$ Without distinct damage in appearance	(1) Store temperature : +125 $\pm 2^{\circ}\text{C}$ for total 1,000 + 4 / - 0 hours

Note1 : When there are questions concerning measurement result : measurement shall be made after 48 ± 2 hours of recovery under the standard condition

8. Care note

8-1 Care note for Use

(1) Storage Condition :

Temperature 25 to 35°C, Humidity 45 to 85% RH

(2) Use Temperature :

- a. Minimum Temperature : -55°C Ambient temperature of power choke coil.
- b. Maximum Temperature : +125°C The value of temperature including ambient of the transformer and temperature rise of power choke coil.
- c. There is not a problem from -55°C ~ +125°C in a reliability test.
- d. However, this is not meant a temperature grade guarantee of UL.

(3) Model :

When this power choke coil was used in a similar or new product to the original one, sometimes it might be unable to satisfy the specifications due to difference of condition of usage.

(4) Drop :

If the power choke coil suffered mechanical stress such as drop, characteristics may become poor (due to damage on coil bobbin, etc.).

Never use such stressed power choke coil.

8-2 Care note for Safety

(1) Provision to Abnormal Condition

This power choke coil itself does not have any protective function in abnormal condition such as overload, short-circuit and open-circuit conditions, etc.

Therefore, it shall be confirmed as the end product that there is no risk of smoking, fire, dielectric withstand voltage, insulation resistance, etc. in abnormal conditions to provide protective devices and/or protection circuit in the end product.

(2) Temperature Rise

Temperature rise of power choke coil depends on the installation condition on end products.

It shall be confirmed on the actual end product that temperature rise of power choke coil is in the limit of specified temperature class.

(3) Dielectric Strength

Dielectric withstanding test with higher voltage than specific value will damage insulating material and shorten its life.

(4) Water

This power choke coil must not be used in wet condition by water, coffee or any liquid because insulation strength becomes very low on the condition.

(5) Potting

If this power choke coil is potted in some compound, coating material of magnet wire might be occasionally damaged. Please ask us if you intend to pot this power choke coil.

(6) Detergent

Please consult our company once in case of this because the confirmation of reliability etc. is needed when the washing medicine is used for the power choke coil.

Appendix A

Sn plating Reflow Profile

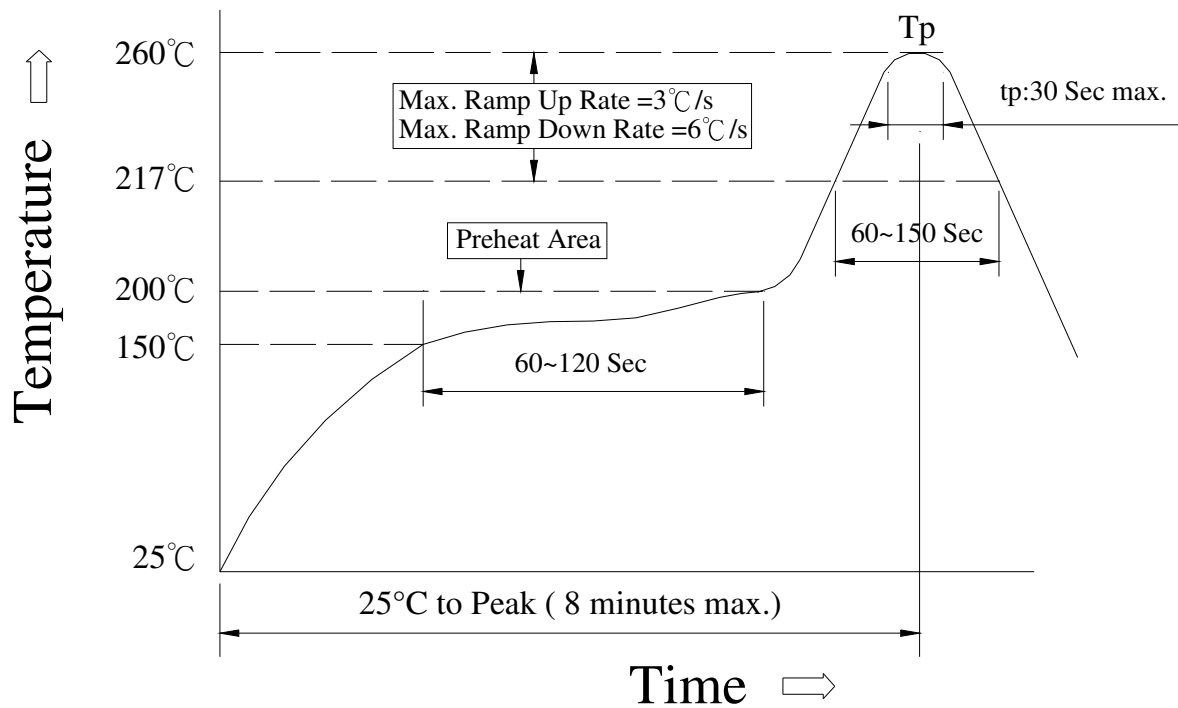

(1) Reflow Soldering Method :

Reflow Soldering	Tp:255~260°C	Max.30 seconds (tp)
	217°C	60~150 seconds
Pre-Heat	150 ~ 200°C	60~120 seconds
Time 25°C to peak temperature	8 minutes max.	

(2) Soldering iron Method : 350± 5°C max.3 second

Sealed Choke Coil Packaging Methods

■ Tape packaging dimensions

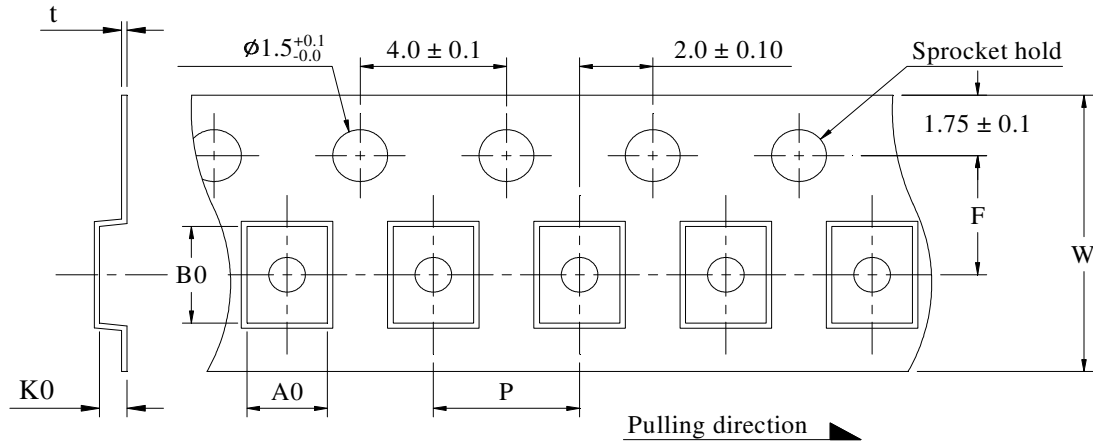

Type	Dimensions Code							UNITS / REEL
	A0	B0	K0	t	P	W	F	
12101T	1.35 ± 0.10	1.63 ± 0.10	1.15 ± 0.10	0.23 ± 0.05	4.00 ± 0.10	8.00 ± 0.30	3.50 ± 0.10	2,000
20121T	1.46 ± 0.05	2.30 ± 0.05	1.20 ± 0.05	0.22 ± 0.05	4.00 ± 0.10	8.00 ± 0.30	3.50 ± 0.10	2,000
20161T	1.84 ± 0.05	2.25 ± 0.05	1.15 ± 0.05	0.22 ± 0.05	4.00 ± 0.10	8.00 ± 0.30	3.50 ± 0.10	2,000
20161B	1.80 ± 0.05	2.22 ± 0.05	1.35 ± 0.10	0.22 ± 0.05	4.00 ± 0.10	8.00 ± 0.30	3.50 ± 0.10	2,000
25201T	2.30 ± 0.10	2.85 ± 0.10	1.20 ± 0.10	0.23 ± 0.05	4.00 ± 0.10	8.00 ± 0.30	3.50 ± 0.10	2,000
25201B	2.50 ± 0.10	3.00 ± 0.10	1.60 ± 0.10	0.25 ± 0.05	4.00 ± 0.10	8.00 ± 0.30	3.50 ± 0.10	2,000
32251B	2.85 ± 0.10	3.50 ± 0.10	1.50 ± 0.10	0.25 ± 0.05	4.00 ± 0.10	8.00 ± 0.30	3.50 ± 0.10	2,000
031T	3.20 ± 0.10	3.30 ± 0.10	1.40 ± 0.10	0.24 ± 0.05	4.00 ± 0.10	8.00 ± 0.30	3.50 ± 0.10	2,000
031B	3.20 ± 0.10	3.30 ± 0.10	1.40 ± 0.10	0.24 ± 0.05	4.00 ± 0.10	8.00 ± 0.30	3.50 ± 0.10	2,000
041T	4.30 ± 0.10	4.40 ± 0.10	1.50 ± 0.15	0.25 ± 0.05	8.00 ± 0.10	12.0 ± 0.30	5.50 ± 0.10	2,000
041B	4.30 ± 0.10	4.40 ± 0.10	1.50 ± 0.15	0.25 ± 0.05	8.00 ± 0.10	12.0 ± 0.30	5.50 ± 0.10	2,000
041E	4.50 ± 0.10	4.40 ± 0.10	1.85 ± 0.15	0.30 ± 0.05	8.00 ± 0.10	12.0 ± 0.30	5.50 ± 0.10	2,000
041H	4.40 ± 0.10	4.40 ± 0.10	2.30 ± 0.10	0.26 ± 0.05	8.00 ± 0.10	12.0 ± 0.30	5.50 ± 0.10	2,000
043T	4.40 ± 0.10	4.40 ± 0.10	3.20 ± 0.10	0.35 ± 0.05	8.00 ± 0.10	12.0 ± 0.30	5.50 ± 0.10	2,000

CYNTEC CO., LTD.

乾坤科技股份有限公司

DOCUMENT : ECG-148-001

REVISION : A1

PAGE : 2 OF 4

Type	Dimensions Code							UNITS / REEL
	A0	B0	K0	t	P	W	F	
054T	5.30 ± 0.10	5.30 ± 0.10	4.10 ± 0.10	0.40 ± 0.05	8.00 ± 0.10	12.0 ± 0.30	5.50 ± 0.10	1,200
061B	6.30 ± 0.10	6.30 ± 0.10	1.50 ± 0.10	0.30 ± 0.05	12.0 ± 0.10	16.0 ± 0.30	7.50 ± 0.10	2,000
062H	6.20 ± 0.10	6.30 ± 0.10	3.10 ± 0.10	0.40 ± 0.05	8.00 ± 0.10	16.0 ± 0.30	7.50 ± 0.10	2,000
064T	6.35 ± 0.10	6.35 ± 0.10	4.25 ± 0.10	0.40 ± 0.05	12.0 ± 0.10	16.0 ± 0.30	7.50 ± 0.10	1,000

■ Reel dimensions

A: $\phi 178$

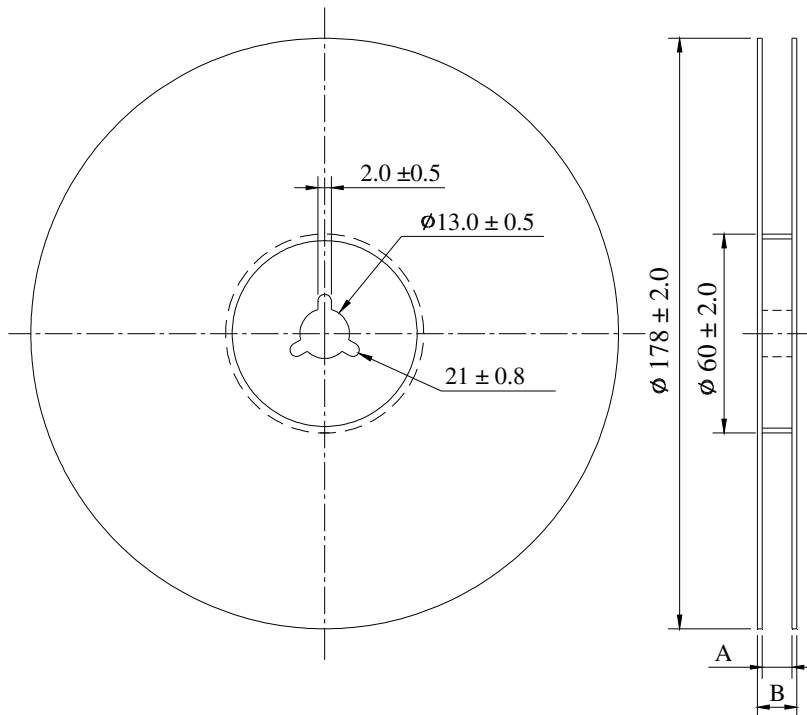

Series	A	B
12101T	9.0±0.3	11.4±1.0
20121T、20161T、20161B、25201T、25201B		
32251B、031T、031B		

Unit : mm

B: $\phi 330$

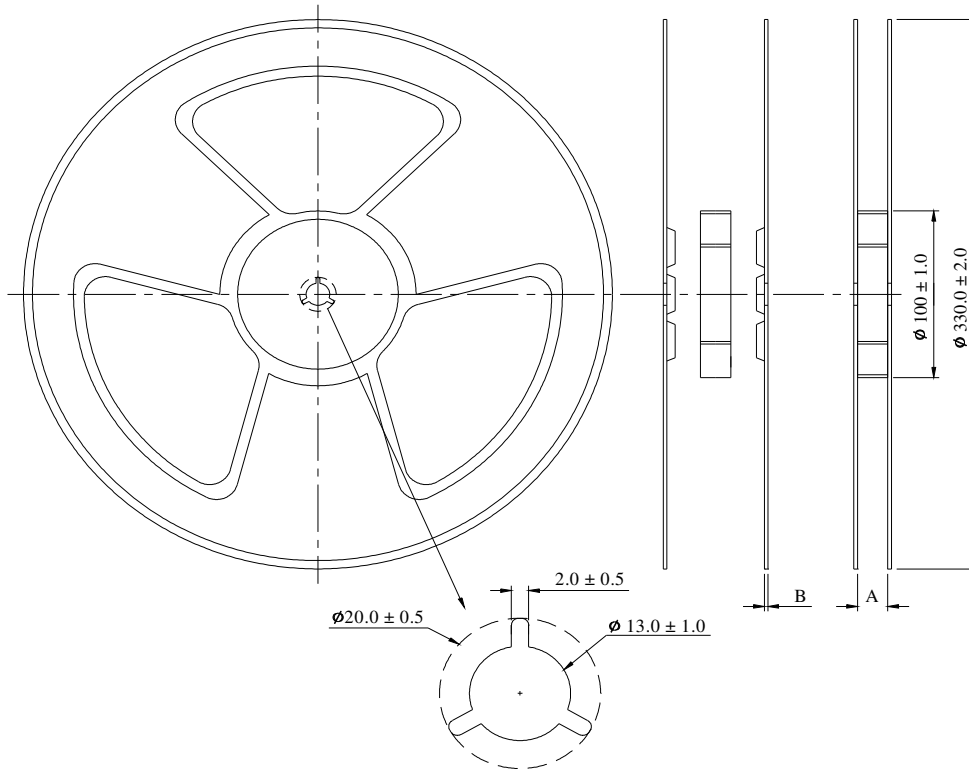

Series	A	B
041T、041B、041E、041H 043T	12.5±0.5	2.0±0.2
054T		
061B、062H、064T	16.0±0.5	2.0±0.2

Unit : mm

Peel force of top cover tape

Peel force of top cover tape

The peel speed shall be about 300 mm/minute

The peel force of top cover tape shall be between 0.1 to 0.7 N

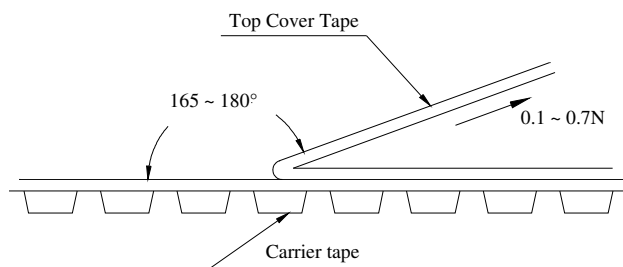

X-ON Electronics

Largest Supplier of Electrical and Electronic Components

Click to view similar products for [cynotech](#) manufacturer:

Other Similar products are found below :

[HTQH25201T-1R0MSR](#) [PIFE32251B-1R0MS](#) [PIBRELLA](#) [CTLPADDLE40-01](#) [HTQH25201T-1R0MTR](#) [HMMQ20161T-1R5MDR](#)
[CTLBREAK-TCOBB40-01](#) [HTQH20161T-R47MSR](#) [PIFE25201T-R22MS](#) [LISIPAROIWHT-01](#) [WEATHERHAT-01](#) [USBPLU-BLACK-01](#)
[PCMC133E-R82MF](#) [LISIPAROIIR-01](#) [PIME104T-R36MS0R765](#) [TBL-1005-245-MA1](#) [MUN3C1HR6-FB](#) [MUN12AD06-SM](#) [RBPLU-](#)
[BLACK-PI3](#) [SDBPLU-BLACK-01](#) [PIFE25201T-R47MS](#) [PCMB104T-1R0MT](#) [PCMB104T-R22MS](#) [PIME104T-R68MS1R607](#)
[HMMQ25201T-1R0MSR](#) [MUN12AD01-SH](#) [PCSB20161T-1R0MS](#) [PCMB104T-1R5MS](#) [PCMB104T-150MS](#) [PMLT25201B-2R2MS](#)
[RL3720WT-R010-FNH](#) [MUN3CAD01-SC](#) [PCSB20161T-R47MS](#) [CMLE061E-2R2MS](#) [PMLT25201B-1R0MS](#) [TBL-1608-245-MA3](#)
[PCMB063T-4R7MS](#) [PCMB063T-R68MS](#) [PIFE32251B-2R2MS](#) [HTQH20160H-1R0MIR](#) [HTQH20160H-2R2MSR](#) [PCSB20161T-1R5MS](#)
[SDTM20161T-4R7MS](#) [PCSB25201T-1R5MS](#) [PIFE20161B-R47MS](#) [PST031T-100MS](#) [SDTM25201T-4R7MS](#) [PCMB063T-3R3MS](#)
[PCSB25201T-R47MS](#) [HTQH16080H-R47MSR](#)