

**2.5 V or 3.3 V, 200 MHz,
1:9 Clock Distribution Buffer**

Features

- 2.5 V or 3.3 V operation
- 200 MHz clock support
- LVCMOS-/LVTTTL-compatible inputs
- 9 clock outputs: drive up to 18 clock lines
- Synchronous Output Enable
- Output three-state control
- 250 ps max. output-to-output skew
- Pin compatible with MPC947, MPC9447
- Available in Industrial and Commercial temp. range
- 32-pin TQFP package

Functional Description

The CY29947 is a low-voltage 200 MHz clock distribution buffer with the capability to select one of two LVCMOS/LVTTL compatible clock inputs. The two clock sources can be used to provide for a test clock as well as the primary system clock. All other control inputs are LVCMOS/LVTTL compatible. The 9 outputs are LVCMOS or LVTTTL compatible and can drive 50 Ω series or parallel terminated transmission lines. For series terminated transmission lines, each output can drive one or two traces giving the device an effective fanout of 1:18. The outputs can also be three-stated via the three-state input TS#. Low output-to-output skews make the CY29947 an ideal clock distribution buffer for nested clock trees in the most demanding of synchronous systems.

The CY29947 also provides a synchronous output enable input for enabling or disabling the output clocks. Since this input is internally synchronized to the input clock, potential output glitching or runt pulse generation is eliminated.

For a complete list of related documentation, [click here](#).

Block Diagram

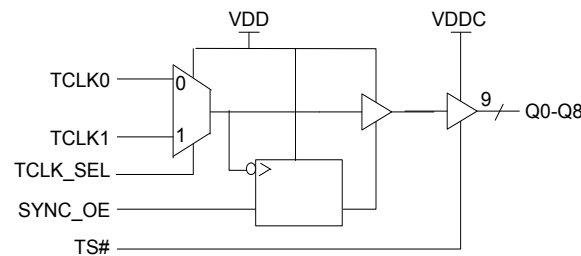

Contents

Pinouts	3	Acronyms	10
Pin Definitions	3	Document Conventions	10
Output Enable/Disable	4	Units of Measure	10
Maximum Ratings	5	Revision History	11
DC Parameters	5	Sales, Solutions, and Legal Information	12
Thermal Resistance	5	Worldwide Sales and Design Support	12
AC Parameters	6	Products	12
Ordering Information	8	PSoC@Solutions	12
Ordering Code Definitions	8	Cypress Developer Community	12
Package Drawing and Dimension	9	Technical Support	12

Output Enable/Disable

The CY29947 features a control input to enable or disable the outputs. This data is latched on the falling edge of the input clock. When SYNC_OE is asserted LOW, the outputs are disabled in a LOW state. When SYNC_OE is set HIGH, the outputs are enabled as shown in [Figure 2](#).

Figure 2. SYNC_OE Timing Diagram

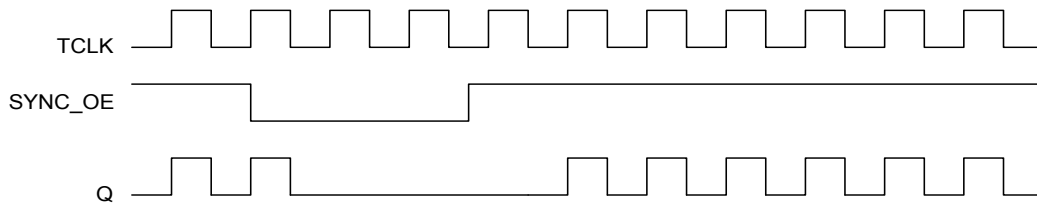

Maximum Ratings

Exceeding maximum ratings ^[2] may shorten the useful life of the device. User guidelines are not tested.

- Maximum Input Voltage Relative to V_{SS}: V_{SS} – 0.3 V
- Maximum Input Voltage Relative to V_{DD}: V_{DD} + 0.3 V
- Storage Temperature: –65 °C to + 150 °C
- Operating Temperature: –40 °C to +85 °C
- Maximum ESD protection 2 kV

- Maximum Power Supply: 5.5 V
- Maximum Input Current: ±20 mA

This device contains circuitry to protect the inputs against damage due to high static voltages or electric field; however, precautions should be taken to avoid application of any voltage higher than the maximum rated voltages to this circuit. For proper operation, V_{in} and V_{out} should be constrained to the range:

$$V_{SS} < (V_{in} \text{ or } V_{out}) < V_{DD}$$

Unused inputs must always be tied to an appropriate logic voltage level (either V_{SS} or V_{DD}).

DC Parameters

V_{DD} = V_{DDC} = 3.3 V ± 10% or 2.5 V ± 5%, Over the specified temperature range

Parameter	Description	Conditions	Min	Typ	Max	Unit
V _{IL}	Input Low Voltage		V _{SS}	–	0.8	V
V _{IH}	Input High Voltage		2.0	–	V _{DD}	V
I _{IL}	Input Low Current ^[3]		–	–	–100	µA
I _{IH}	Input High Current ^[3]		–	–	10	µA
V _{OL}	Output Low Voltage ^[4]	I _{OL} = 20 mA	–	–	0.4	V
V _{OH}	Output High Voltage ^[4]	I _{OH} = –20 mA, V _{DD} = 3.3 V	2.5	–	–	V
		I _{OH} = –20 mA, V _{DD} = 2.5 V	1.8	–	–	
I _{DDQ}	Quiescent Supply Current		–	5	7	mA
I _{DD}	Dynamic Supply Current	V _{DD} = 3.3 V, Outputs @ 100 MHz, CL = 30 pF	–	120	–	mA
		V _{DD} = 3.3 V, Outputs @ 160 MHz, CL = 30 pF	–	200	–	
		V _{DD} = 2.5 V, Outputs @ 100 MHz, CL = 30 pF	–	85	–	
		V _{DD} = 2.5 V, Outputs @ 160 MHz, CL = 30 pF	–	140	–	
Z _{out}	Output Impedance	V _{DD} = 3.3 V	12	15	18	Ω
		V _{DD} = 2.5 V	14	18	22	
C _{in}	Input Capacitance		–	4	–	pF

Thermal Resistance

Parameter ^[5]	Description	Test Conditions	32-pin TQFP	Unit
θ _{JA}	Thermal resistance (junction to ambient)	Test conditions follow standard test methods and procedures for measuring thermal impedance, in accordance with EIA/JESD51.	65	°C/W
θ _{JC}	Thermal resistance (junction to case)		12	°C/W

Notes

2. **Multiple Supplies:** The voltage on any input or I/O pin cannot exceed the power pin during power-up. Power supply sequencing is NOT required.
3. Inputs have pull-up/pull-down resistors that effect input current.
4. Driving series or parallel terminated 50 Ω (or 50 Ω to V_{DD}/2) transmission lines.
5. These parameters are guaranteed by design and are not tested.

AC Parameters

$V_{DD} = V_{DDC} = 3.3\text{ V} \pm 10\%$ or $2.5\text{ V} \pm 5\%$, Over the specified temperature range

Parameter ^[6]	Description	Conditions	Min	Typ	Max	Unit
Fmax	Input Frequency ^[7]	$V_{DD} = 3.3\text{ V}$	–	–	200	MHz
		$V_{DD} = 2.5\text{ V}$	–	–	170	
Tpd	TCLK To Q Delay ^[7]	$V_{DD} = 3.3\text{ V}$	4.75	–	9.25	ns
		$V_{DD} = 2.5\text{ V}$	6.50	–	10.50	
FoutDC	Output Duty Cycle ^[7, 8]	Measured at $V_{DD}/2$	45	–	55	%
tpZL, tpZH	Output Enable Time (all outputs)		2	–	10	ns
tpLZ, tpHZ	Output Disable Time (all outputs)		2	–	10	ns
Tskew	Output-to-Output Skew ^[7, 9]		–	150	250	ps
Tskew(pp)	Part-to-Part Skew ^[10]		–	–	2.0	ns
Ts	Set-up Time ^[7, 11]	SYNC_OE to TCLK	0.0	–	–	ps
Th	Hold Time ^[7, 11]	TCLK to SYNC_OE	1.0	–	–	ps
Tr/Tf	Output Clocks Rise/Fall Time ^[9]	0.8 V to 2.0 V, $V_{DD} = 3.3\text{ V}$	0.20	–	1.0	ns
		0.6 V to 1.8 V, $V_{DD} = 2.5\text{ V}$	0.20	–	1.3	

Notes

6. Parameters are guaranteed by design and characterization. Not 100% tested in production. All parameters specified with loaded outputs.
7. Outputs driving 50 Ω transmission lines.
8. 50% input duty cycle.
9. See [Figure 3 on page 7](#).
10. Part-to-Part skew at a given temperature and voltage.
11. Set-up and hold times are relative to the falling edge of the input clock.

Figure 3. LVCMOS_CLK CY29947 Test Reference for $V_{CC} = 3.3\text{ V}$ and $V_{CC} = 2.5\text{ V}$

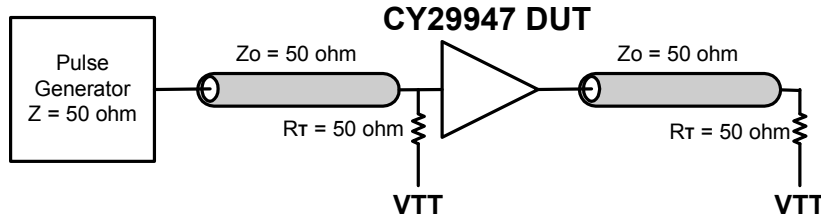

Figure 4. LVCMOS Propagation Delay (TPD) Test Reference

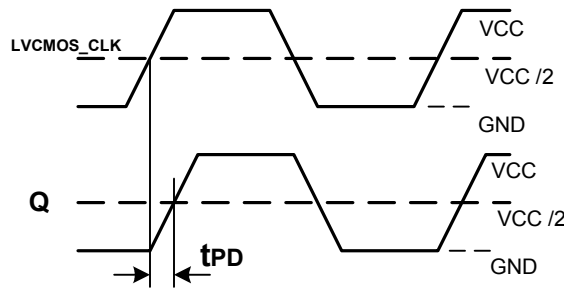

Figure 5. Output Duty Cycle (FoutDC)

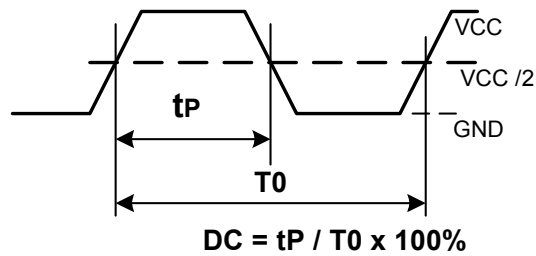
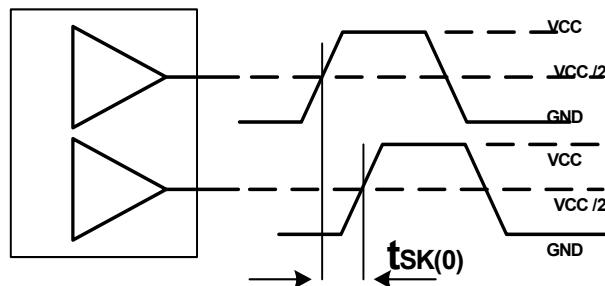

Figure 6. Output-to-Output Skew tsk(0)



Ordering Information

Part Number	Package Type	Production Flow
CY29947AXI	32-pin TQFP	Industrial, -40 °C to +85 °C
CY29947AXIT	32-pin TQFP – Tape and Reel	Industrial, -40 °C to +85 °C

Ordering Code Definitions

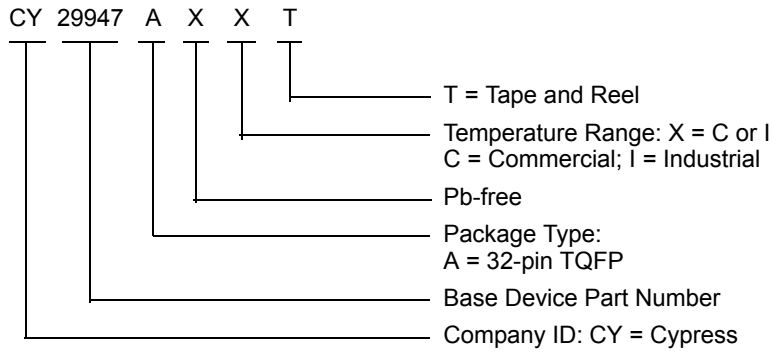

Package Drawing and Dimension

Figure 7. 32-pin TQFP (7 × 7 × 1.0 mm) Package Outline, 51-85063

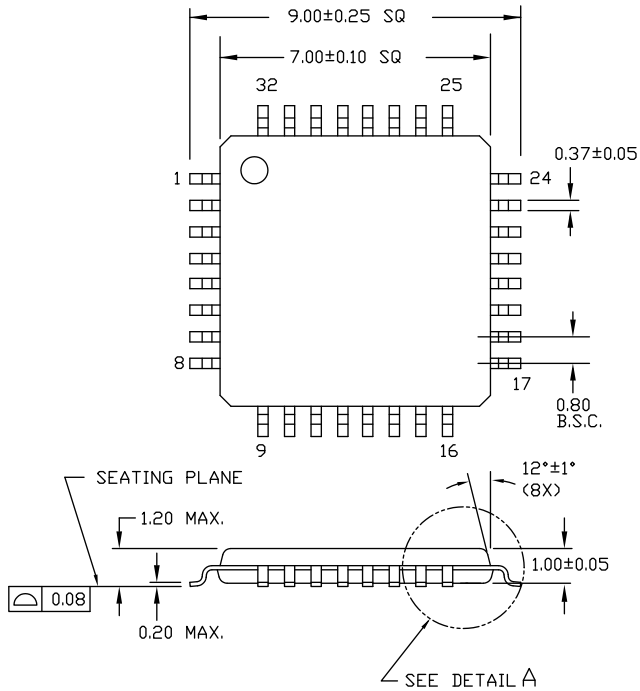

DIMENSIONS ARE IN MILLIMETERS

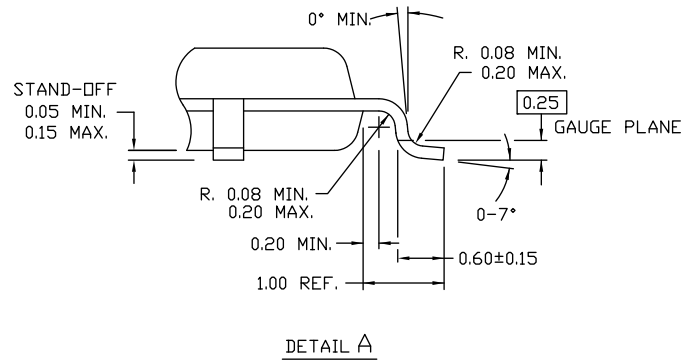

51-85063 *E

Acronyms

Acronym	Description
CMOS	Complementary Metal Oxide Semiconductor
ESD	Electrostatic Discharge
I/O	Input/Output
LVC MOS	Low Voltage Complementary Metal Oxide Semiconductor
LV TTL	Low Voltage Transistor-Transistor Logic
PLL	Phase Locked Loop
TQFP	Thin Quad Flat Pack
VCO	Voltage-Controlled Oscillator

Document Conventions

Units of Measure

Symbol	Unit of Measure
°C	degree Celsius
Hz	hertz
kHz	kilohertz
kV	kilovolt
MHz	megahertz
µA	microampere
mA	milliampere
ms	millisecond
mV	millivolt
ns	nanosecond
Ω	ohm
%	percent
pF	picofarad
ps	picosecond
V	volt
W	watt

Revision History

Document Title: CY29947, 2.5 V or 3.3 V, 200 MHz, 1:9 Clock Distribution Buffer				
Document Number: 38-07287				
Rev.	ECN No.	Issue Date	Orig. of Change	Description of Change
**	111098	02/07/02	BRK	New data sheet
*A	116781	08/14/02	HWT	Added Commercial Temperature Range in the ordering information
*B	118462	09/09/02	HWT	Corrected the Package Drawing and Dimension in page 6 from 32 LQFP to 32 TQFP
*C	122879	12/22/02	RBI	Added power up requirements to Maximum Ratings
*D	2899714	03/26/10	BASH	Removed inactive parts from the ordering table. Replaced with active parts. Updated package diagram
*E	3163585	02/05/2011	CXQ	Added Ordering Code Definitions . Added Acronyms and Units of Measure . Updated to new template.
*F	4311272	03/17/2014	CINM	Updated Package Drawing and Dimension : spec 51-85063 – Changed revision from *C to *D. Updated to new template. Completing Sunset Review.
*G	4586288	12/03/2014	CINM	Updated Functional Description : Added “For a complete list of related documentation, click here .” at the end. Updated Ordering Information : Removed the prune part numbers CY29947AXC and CY29947AXCT.
*H	5270507	05/13/2016	PSR	Added Thermal Resistance . Updated Package Drawing and Dimension : spec 51-85063 – Changed revision from *D to *E. Updated to new template.

Sales, Solutions, and Legal Information

Worldwide Sales and Design Support

Cypress maintains a worldwide network of offices, solution centers, manufacturer's representatives, and distributors. To find the office closest to you, visit us at [Cypress Locations](#).

Products

ARM® Cortex® Microcontrollers	cypress.com/arm
Automotive	cypress.com/automotive
Clocks & Buffers	cypress.com/clocks
Interface	cypress.com/interface
Lighting & Power Control	cypress.com/powerpsoc
Memory	cypress.com/memory
PSoC	cypress.com/psoc
Touch Sensing	cypress.com/touch
USB Controllers	cypress.com/usb
Wireless/RF	cypress.com/wireless

PSoC® Solutions

[PSoC 1](#) | [PSoC 3](#) | [PSoC 4](#) | [PSoC 5LP](#)

Cypress Developer Community

[Forums](#) | [Projects](#) | [Video](#) | [Blogs](#) | [Training](#) | [Components](#)

Technical Support

cypress.com/support

© Cypress Semiconductor Corporation, 2002-2016. This document is the property of Cypress Semiconductor Corporation and its subsidiaries, including Spansion LLC ("Cypress"). This document, including any software or firmware included or referenced in this document ("Software"), is owned by Cypress under the intellectual property laws and treaties of the United States and other countries worldwide. Cypress reserves all rights under such laws and treaties and does not, except as specifically stated in this paragraph, grant any license under its patents, copyrights, trademarks, or other intellectual property rights. If the Software is not accompanied by a license agreement and you do not otherwise have a written agreement with Cypress governing the use of the Software, then Cypress hereby grants you a personal, non-exclusive, nontransferable license (without the right to sublicense) (1) under its copyright rights in the Software (a) for Software provided in source code form, to modify and reproduce the Software solely for use with Cypress hardware products, only internally within your organization, and (b) to distribute the Software in binary code form externally to end users (either directly or indirectly through resellers and distributors), solely for use on Cypress hardware product units, and (2) under those claims of Cypress's patents that are infringed by the Software (as provided by Cypress, unmodified) to make, use, distribute, and import the Software solely for use with Cypress hardware products. Any other use, reproduction, modification, translation, or compilation of the Software is prohibited.

TO THE EXTENT PERMITTED BY APPLICABLE LAW, CYPRESS MAKES NO WARRANTY OF ANY KIND, EXPRESS OR IMPLIED, WITH REGARD TO THIS DOCUMENT OR ANY SOFTWARE OR ACCOMPANYING HARDWARE, INCLUDING, BUT NOT LIMITED TO, THE IMPLIED WARRANTIES OF MERCHANTABILITY AND FITNESS FOR A PARTICULAR PURPOSE. To the extent permitted by applicable law, Cypress reserves the right to make changes to this document without further notice. Cypress does not assume any liability arising out of the application or use of any product or circuit described in this document. Any information provided in this document, including any sample design information or programming code, is provided only for reference purposes. It is the responsibility of the user of this document to properly design, program, and test the functionality and safety of any application made of this information and any resulting product. Cypress products are not designed, intended, or authorized for use as critical components in systems designed or intended for the operation of weapons, weapons systems, nuclear installations, life-support devices or systems, other medical devices or systems (including resuscitation equipment and surgical implants), pollution control or hazardous substances management, or other uses where the failure of the device or system could cause personal injury, death, or property damage ("Unintended Uses"). A critical component is any component of a device or system whose failure to perform can be reasonably expected to cause the failure of the device or system, or to affect its safety or effectiveness. Cypress is not liable, in whole or in part, and you shall and hereby do release Cypress from any claim, damage, or other liability arising from or related to all Unintended Uses of Cypress products. You shall indemnify and hold Cypress harmless from and against all claims, costs, damages, and other liabilities, including claims for personal injury or death, arising from or related to any Unintended Uses of Cypress products.

Cypress, the Cypress logo, Spansion, the Spansion logo, and combinations thereof, PSoC, CapSense, EZ-USB, F-RAM, and Traveo are trademarks or registered trademarks of Cypress in the United States and other countries. For a more complete list of Cypress trademarks, visit cypress.com. Other names and brands may be claimed as property of their respective owners.

X-ON Electronics

Largest Supplier of Electrical and Electronic Components

Click to view similar products for [Clock Drivers & Distribution](#) category:

Click to view products by [Cypress](#) manufacturer:

Other Similar products are found below :

[8501BYLF](#) [P9090-0NLGI8](#) [854110AKILF](#) [83210AYLF](#) [NB6VQ572MMNG](#) [4RCD0232KC1ATG](#) [6ES7390-1AF30-0AA0](#)
[CDCVF2505IDRQ1](#) [NB7L572MNR4G](#) [SY100EP33VKG](#) [HMC7043LP7FETR](#) [ISPPAC-CLK5520V-01T100C](#) [EC4P-221-MRXD1](#)
[6EP1332-1SH71](#) [AD246JN](#) [AD246JY](#) [AD9508SCPZ-EP](#) [AD9510BCPZ](#) [AD9510BCPZ-REEL7](#) [AD9511BCPZ](#) [AD9511BCPZ-REEL7](#)
[AD9512BCPZ](#) [AD9512UCPZ-EP](#) [AD9514BCPZ](#) [AD9514BCPZ-REEL7](#) [AD9515BCPZ](#) [AD9515BCPZ-REEL7](#) [AD9572ACPZLVD](#)
[AD9572ACPZPEC](#) [AD9513BCPZ-REEL7](#) [AD9553BCPZ](#) [HMC940LC4B](#) [CSPUA877ABVG8](#) [9P936AFLFT](#) [49FCT805CTQG](#)
[74FCT3807EQGI](#) [74FCT388915TEPYG](#) [853S013AMILF](#) [853S058AGILF](#) [8V79S680NLGI](#) [ISPPAC-CLK5312S-01TN48I](#) [ISPPAC-](#)
[CLK5520V-01TN100I](#) [ISPPAC-CLK5510V-01TN48C](#) [83905AMLFT](#) [8S73034AMILF](#) [8538BG-31LF](#) [49FCT805BTPYG](#)
[49FCT20805PYGI](#) [MAX9320BEUA+](#) [MAX9325EQI](#)