

1:4 Differential LVDS Fanout Buffer with Selectable Clock Input

Features

- Select one of two differential (LVPECL, LVDS, HCSL, or CML) input pairs to distribute to four LVDS output pairs
- Translates any single-ended input signal to 3.3 V LVDS levels with resistor bias on INx# input
- 30 ps maximum output-to-output skew
- 480 ps maximum propagation delay
- 0.11 ps maximum additive RMS phase jitter at 156.25 MHz (12 kHz to 20 MHz offset)
- Up to 1.5 GHz operation
- Output enable and synchronous clock enable functions
- 20-pin TSSOP
- 2.5 V or 3.3 V operating voltage ^[1]
- Commercial and industrial operating temperature range

Functional Description

The CY2DL1504 is an ultra-low noise, low-skew, low-propagation delay 1:4 differential LVDS fanout buffer targeted to meet the requirements of high-speed clock distribution applications. The CY2DL1504 can select between two separate differential (LVPECL, LVDS, HCSL, or CML) input clock pairs using the IN_SEL pin. The synchronous clock enable function ensures glitch-free output transitions during enable and disable periods. The output enable function allows the outputs to be asynchronously driven to a high-impedance state. The device has a fully differential internal architecture that is optimized to achieve low-additive jitter and low-skew at operating frequencies of up to 1.5 GHz.

For a complete list of related documentation, [click here](#).

Logic Block Diagram

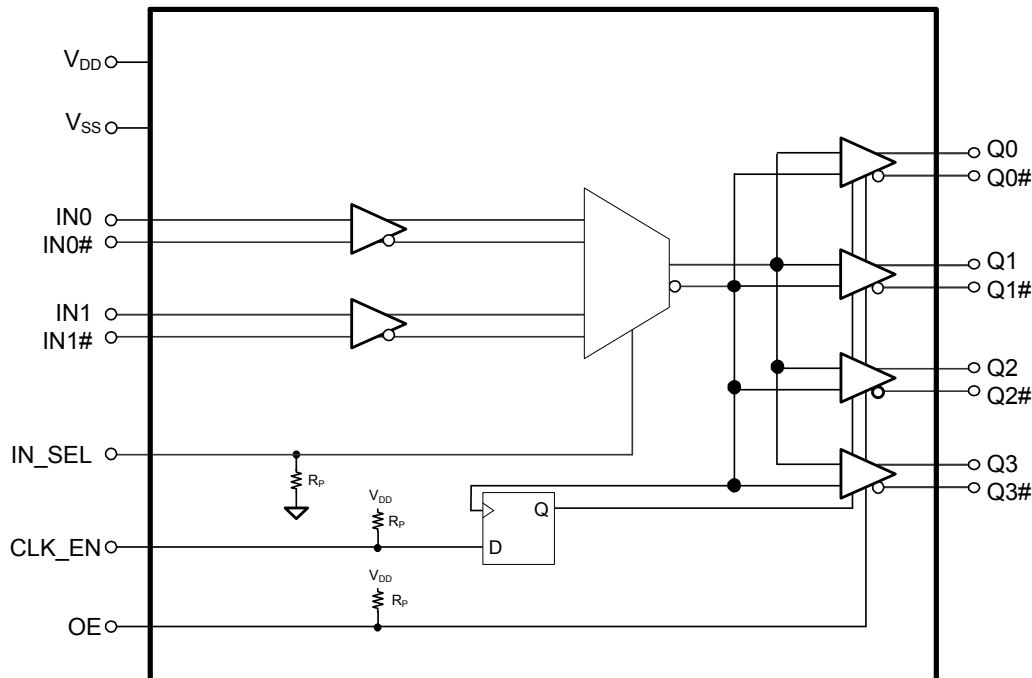

Note

1. Input AC-coupling capacitors are required for voltage-translation applications.

Contents

Pinouts	3	Package Diagram	12
Pin Definitions	3	Acronyms	13
Absolute Maximum Ratings	4	Document Conventions	13
Operating Conditions	4	Units of Measure	13
DC Electrical Specifications	5	Document History Page	14
Thermal Resistance	5	Sales, Solutions, and Legal Information	16
AC Electrical Specifications	6	Worldwide Sales and Design Support	16
Switching Waveforms	8	Products	16
Application Information	10	PSoC@Solutions	16
Ordering Information	11	Cypress Developer Community	16
Ordering Code Definitions	11	Technical Support	16

Pinouts

Figure 1. 20-pin TSSOP pinout

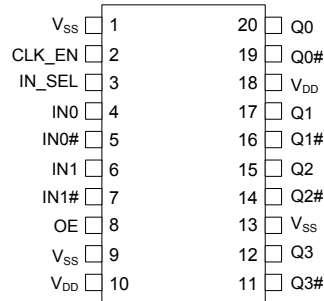

Pin Definitions

Pin No.	Pin Name	Pin Type	Description
1, 9, 13	V _{SS}	Power	Ground
2	CLK_EN	Input	Synchronous clock enable. LVCMOS/LVTTL; When CLK_EN = Low, Q(0:3) outputs are held low and Q(0:3)# outputs are held high
3	IN_SEL	Input	Input clock select pin. LVCMOS/LVTTL; When IN_SEL = Low, the IN0/IN0# differential input pair is active When IN_SEL = High, the IN1/IN1# differential input pair is active
4	IN0	Input	Differential (LVPECL, HCSSL, LVDS, or CML) input clock. Active when IN_SEL = Low
5	IN0#	Input	Differential (LVPECL, HCSSL, LVDS, or CML) complementary input clock. Active when IN_SEL = Low
6	IN1	Input	Differential (LVPECL, HCSSL, LVDS, or CML) input clock. Active when IN_SEL = High
7	IN1#	Input	Differential (LVPECL, HCSSL, LVDS, or CML) complementary input clock. Active when IN_SEL = High
8	OE	Input	Output enable. LVCMOS/LVTTL; When OE = Low, Q(0:3) and Q(0:3)# outputs are disabled (see I _{OZ})
10, 18	V _{DD}	Power	Power supply
11, 14, 16, 19	Q(0:3)#	Output	LVDS complementary output clocks
12, 15, 17, 20	Q(0:3)	Output	LVDS output clocks

Absolute Maximum Ratings

Parameter	Description	Condition	Min	Max	Unit
V_{DD}	Supply voltage	Nonfunctional	-0.5	4.6	V
$V_{IN}^{[2]}$	Input voltage, relative to V_{SS}	Nonfunctional	-0.5	Lesser of 4.0 or $V_{DD} + 0.4$	V
$V_{OUT}^{[2]}$	DC output or I/O voltage, relative to V_{SS}	Nonfunctional	-0.5	Lesser of 4.0 or $V_{DD} + 0.4$	V
T_S	Storage temperature	Nonfunctional	-55	150	°C
ESD_{HBM}	Electrostatic discharge (ESD) protection (Human body model)	JEDEC STD 22-A114-B	2000	-	V
L_U	Latch up		Meets or exceeds JEDEC Spec JESD78B IC latch up test		
UL-94	Flammability rating	At 1/8 in.	V-0		
MSL	Moisture sensitivity level		3		

Operating Conditions

Parameter	Description	Condition	Min	Max	Unit
V_{DD}	Supply voltage	2.5 V supply	2.375	2.625	V
		3.3 V supply	3.135	3.465	V
T_A	Ambient operating temperature	Commercial	0	70	°C
		Industrial	-40	85	°C
t_{PU}	Power ramp time	Power-up time for V_{DD} to reach minimum specified voltage. (Power ramp must be monotonic)	0.05	500	ms

Note

2. The voltage on any I/O pin cannot exceed the power pin during power-up. Power supply sequencing is not required.

DC Electrical Specifications

($V_{DD} = 3.3\text{ V} \pm 5\%$ or $2.5\text{ V} \pm 5\%$; $T_A = 0\text{ }^\circ\text{C}$ to $70\text{ }^\circ\text{C}$ (Commercial) or $-40\text{ }^\circ\text{C}$ to $85\text{ }^\circ\text{C}$ (Industrial))

Parameter	Description	Condition	Min	Max	Unit
I_{DD}	Operating supply current	All LVDS outputs terminated with a load of $100\ \Omega$ [3, 4]	–	61	mA
V_{IH1}	Input high voltage, differential input clocks, IN0, IN0#, IN1, and IN1#		–	$V_{DD} + 0.3$	V
V_{IL1}	Input low voltage, differential input clocks, IN0, IN0#, IN1, and IN1#		–0.3	–	V
V_{IH2}	Input high voltage, CLK_EN, IN_SEL, and OE	$V_{DD} = 3.3\text{ V}$	2.0	$V_{DD} + 0.3$	V
V_{IL2}	Input low voltage, CLK_EN, IN_SEL, and OE	$V_{DD} = 3.3\text{ V}$	–0.3	0.8	V
V_{IH3}	Input high voltage, CLK_EN, IN_SEL, and OE	$V_{DD} = 2.5\text{ V}$	1.7	$V_{DD} + 0.3$	V
V_{IL3}	Input low voltage, CLK_EN, IN_SEL, and OE	$V_{DD} = 2.5\text{ V}$	–0.3	0.7	V
V_{ID_LVDS} [5]	LVDS input differential amplitude	See Figure 3 on page 8	0.4	0.8	V
V_{ID_LVPECL} [5]	LVPECL/CML/HCSL input differential amplitude	See Figure 3 on page 8	0.4	1.0	V
V_{ICM}	Input common mode voltage	See Figure 3 on page 8	0.2	$V_{DD} - 0.2$	V
I_{IH}	Input high current, All inputs	Input = V_{DD} [6]	–	150	μA
I_{IL}	Input low current, All inputs	Input = V_{SS} [6]	–150	–	μA
V_{PP}	LVDS differential output voltage peak to Peak, Single-ended	$V_{DD} = 3.3\text{ V}$ or 2.5 V , $R_{TERM} = 100\ \Omega$ between Q and Q# pairs [3, 7]	250	470	mV
V_{OCM}	LVDS differential output common mode voltage	$V_{DD} = 3.3\text{ V}$ or 2.5 V , $R_{TERM} = 100\ \Omega$ between Q and Q# pairs [3, 7]	1.125	1.375	V
ΔV_{OCM}	Change in V_{OCM} between complementary output states	$V_{DD} = 3.3\text{ V}$ or 2.5 V , $R_{TERM} = 100\ \Omega$ between Q and Q# pairs [3, 7]	–	50	mV
I_{OZ}	Output leakage current	$OE = V_{SS}$, $V_{OUT} = 0.75\text{ V} - 1.75\text{ V}$	–15	15	μA
R_P	Internal pull-up/pull-down resistance, LVCMOS logic inputs	CLK_EN has pull-up only IN_SEL has pull-down only OE has pull-up only	60	165	$\text{k}\Omega$
C_{IN}	Input capacitance	Measured at 10 MHz; per pin	–	3	pF

Thermal Resistance

Parameter [8]	Description	Test Conditions	20-pin TSSOP	Unit
θ_{JA}	Thermal resistance (junction to ambient)	Test conditions follow standard test methods and procedures for measuring thermal impedance, in accordance with EIA/JESD51.	80	$^\circ\text{C}/\text{W}$
θ_{JC}	Thermal resistance (junction to case)		16	$^\circ\text{C}/\text{W}$

Notes

- Refer to Figure 2 on page 8.
- I_{DD} includes current that is dissipated externally in the output termination resistors.
- V_{ID} minimum of 400 mV is required to meet all output AC Electrical Specifications. The device is functional with V_{ID} minimum of greater than 200 mV.
- Positive current flows into the input pin, negative current flows out of the input pin.
- Refer to Figure 4 on page 8.
- These parameters are guaranteed by design and are not tested.

AC Electrical Specifications

($V_{DD} = 3.3\text{ V} \pm 5\%$ or $2.5\text{ V} \pm 5\%$; $T_A = 0\text{ }^\circ\text{C}$ to $70\text{ }^\circ\text{C}$ (Commercial) or $-40\text{ }^\circ\text{C}$ to $85\text{ }^\circ\text{C}$ (Industrial))

Parameter	Description	Condition	Min	Typ	Max	Unit
F _{IN}	Input frequency	Differential Input	DC	–	1.5	GHz
		Single ended input ^[9]	DC	–	250	MHz
F _{OUT}	Output frequency	F _{OUT} = F _{IN} , Differential Input	DC	–	1.5	GHz
		F _{OUT} = F _{IN} , Single ended input ^[9]	DC	–	250	MHz
t _{PD} ^[10]	Propagation delay differential input pair to differential output pair	Input rise/fall time < 1.5 ns (20% to 80%)	–	–	480	ps
t _{ODC} ^[11]	Output duty cycle	Diff input at 50% duty cycle Frequency range up to 1 GHz	48	–	52	%
		50% duty cycle at input, Frequency range up to 250MHz, Single ended input ^[9]	45	–	55	%
t _{SK1} ^[12]	Output-to-output skew	Any output to any output, with same load conditions at DUT	–	–	30	ps
t _{SK1 D} ^[12]	Device-to-device output skew	Any output to any output between two or more devices. Devices must have the same input and have the same output load.	–	–	150	ps
PN _{ADD}	Additive RMS phase noise 156.25 MHz Input Rise/fall time < 150 ps (20% to 80%) V _{ID} > 400 mV or Input Swing = 3.0 V ^[9]	Offset = 1 kHz	–	–	–120	dBc/Hz
		Offset = 10 kHz	–	–	–135	dBc/Hz
		Offset = 100 kHz	–	–	–135	dBc/Hz
		Offset = 1 MHz	–	–	–150	dBc/Hz
		Offset = 10 MHz	–	–	–154	dBc/Hz
		Offset = 20 MHz	–	–	–155	dBc/Hz

Notes

9. Refer to [Application Information](#) on page 10.
10. Refer to [Figure 5](#) on page 8.
11. Refer to [Figure 6](#) on page 8.
12. Refer to [Figure 7](#) on page 9.

AC Electrical Specifications (continued)

 $(V_{DD} = 3.3\text{ V} \pm 5\%$ or $2.5\text{ V} \pm 5\%$; $T_A = 0\text{ }^\circ\text{C}$ to $70\text{ }^\circ\text{C}$ (Commercial) or $-40\text{ }^\circ\text{C}$ to $85\text{ }^\circ\text{C}$ (Industrial))

Parameter	Description	Condition	Min	Typ	Max	Unit
$t_{JIT}^{[13]}$	Additive RMS phase jitter (Random)	156.25 MHz, 12 kHz to 20 MHz offset; input rise/fall time < 150 ps (20% to 80%), $V_{ID} > 400\text{ mV}$	–	–	0.11	ps
		156.25 MHz Sinewave, 12 kHz to 20 MHz offset, input rise/fall time < 150 ps (20% to 80%), Input Swing = 3.0 V ^[14]	–	–	0.11	ps
$t_R, t_F^{[15]}$	Output rise/fall time, single-ended	50% duty cycle at input, 20% to 80% of full swing (V_{OL} to V_{OH}) Input rise/fall time < 1.5 ns (20% to 80%) Measured at 1 GHz.	–	–	300	ps
t_{SOD}	Time from clock edge to outputs disabled	Synchronous clock enable (CLK_EN) switched low	–	–	700	ps
t_{SOE}	Time from clock edge to outputs enabled	Synchronous clock enable (CLK_EN) switched high	–	–	700	ps

Notes

 13. Refer to [Figure 8](#) on page 9.

 14. Refer to [Application Information](#) on page 10.

 15. Refer to [Figure 9](#) on page 9.

Switching Waveforms

Figure 2. LVDS Output Termination

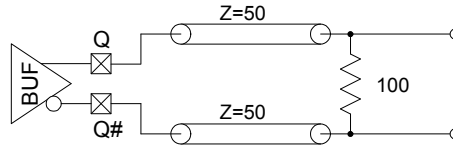

Figure 3. Input Differential and Common Mode Voltages

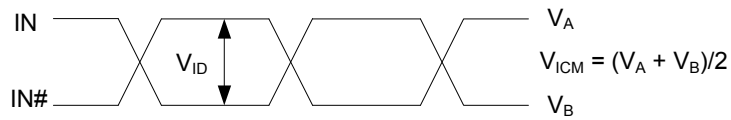

Figure 4. Output Differential and Common Mode Voltages

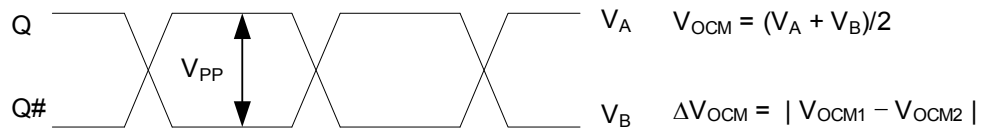

Figure 5. Input to Any Output Pair Propagation Delay

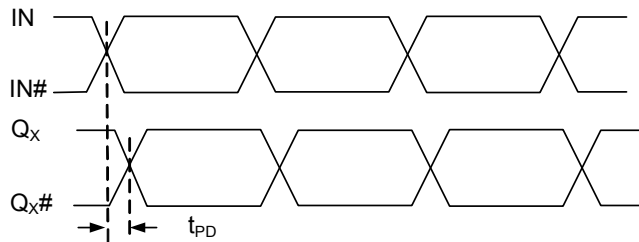
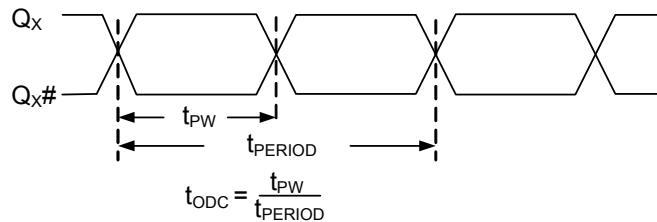

Figure 6. Output Duty Cycle



Switching Waveforms (continued)

Figure 7. Output-to-output and Device-to-device Skew

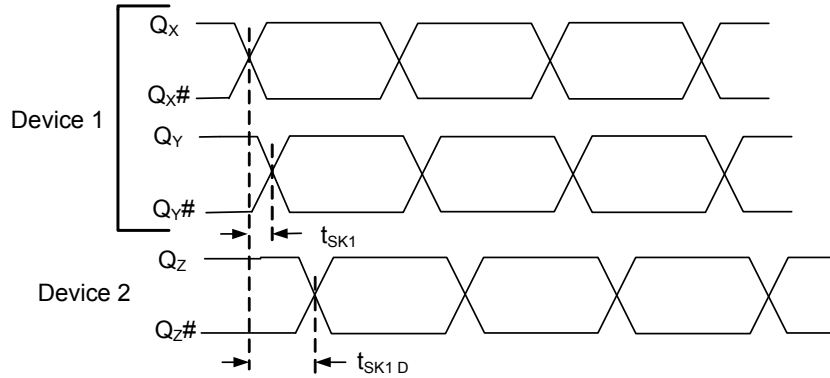

Figure 8. RMS Phase Jitter

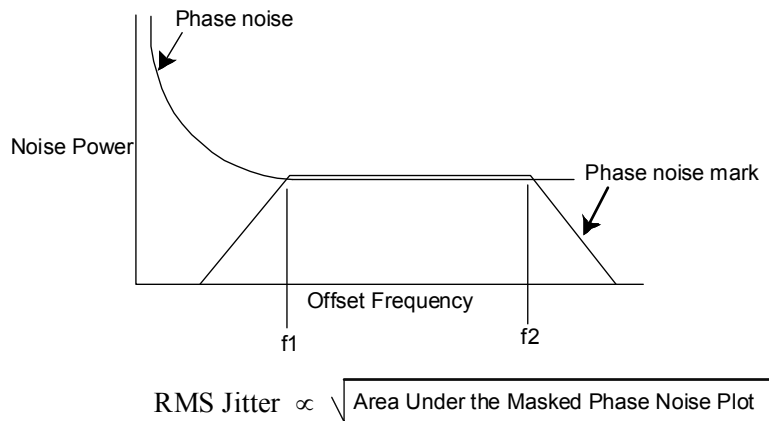
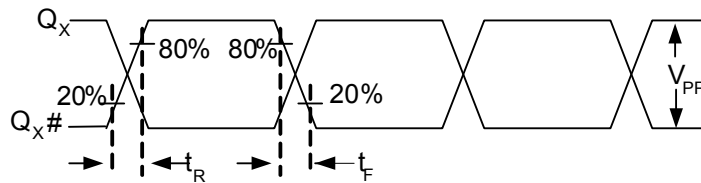
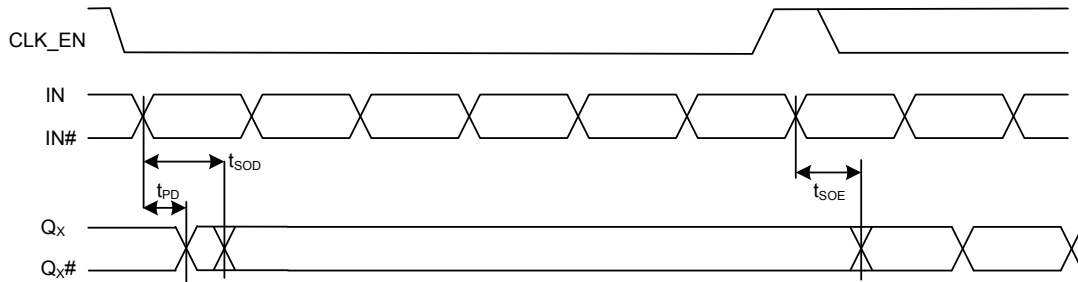

Figure 9. Output Rise/Fall Time



Switching Waveforms (continued)

Figure 10. Synchronous Clock Enable Timing



Application Information

CY2DL1504 can be used with a single ended CMOS input by biasing the Complementary Input Clock (INx#). “True” input pins (INx) of differential input pair can be fed with a single ended CMOS input signal. The “complementary” input pin (INx#) of the same differential input pair can be biased with Vref.

Figure 11 shows the schematic which can be used to give single ended CMOS input to the CY2DL1504.

The reference voltage $V_{ref} = VDD/2$ is generated by the bias resistors R1, R2 and capacitor C0. This bias circuit should be located as close as possible to the input pin. The ratio of R1 and R2 might need to be adjusted to position the Vref in the center of the input voltage swing. For example, if the input clock swing is 2.5 V and $VDD = 3.3$ V, V_{ref} should be 1.25 V and $R2/R1 = 0.609$.

Figure 11. Single ended CMOS input given to the CY2DL1504

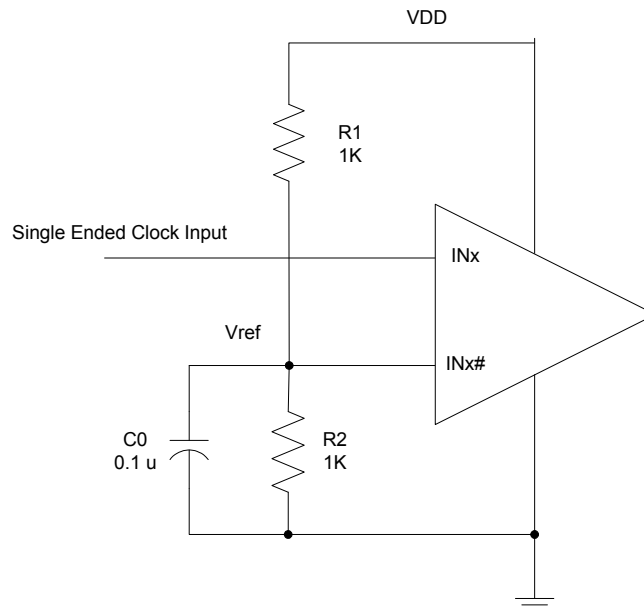

Ordering Information

Part Number	Type	Production Flow
Pb-free		
CY2DL1504ZXC	20-pin TSSOP	Commercial, 0 °C to 70 °C
CY2DL1504ZXCT	20-pin TSSOP	Commercial, 0 °C to 70 °C
CY2DL1504ZXI	20-pin TSSOP	Industrial, -40 °C to 85 °C
CY2DL1504ZXIT	20-pin TSSOP	Industrial, -40 °C to 85 °C

Ordering Code Definitions

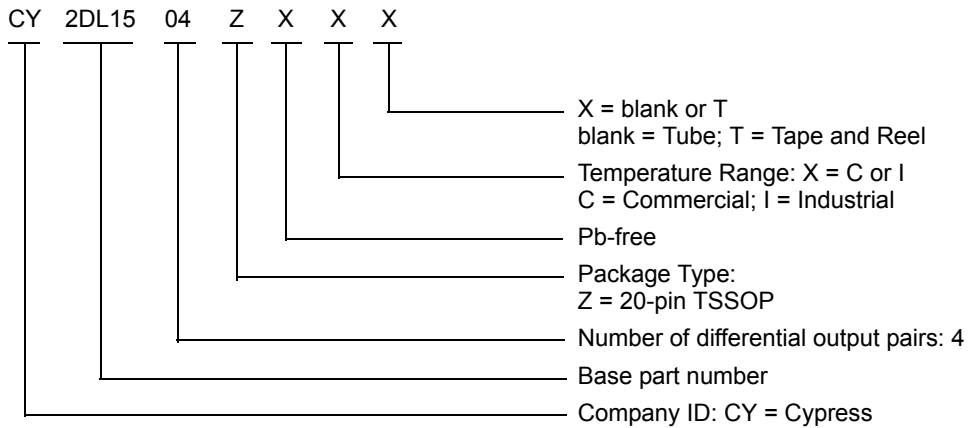

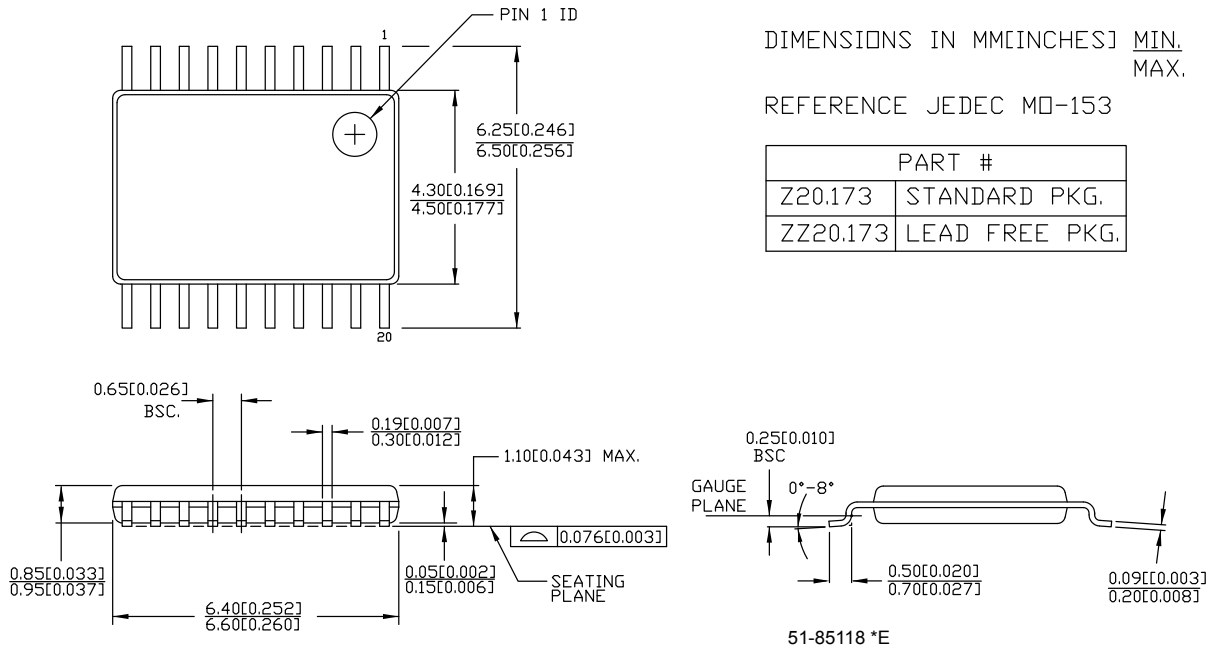
Package Diagram
Figure 12. 20-pin TSSOP (4.40 mm Body) Z20.173/ZZ20.173 Package Outline, 51-85118

Acronyms

Acronym	Description
ESD	electrostatic discharge
HBM	human body model
HCSL	high-speed current steering logic
JEDEC	joint electron devices engineering council
LVDS	low-voltage differential signal
LVC MOS	low-voltage complementary metal oxide semiconductor
LVPECL	low-voltage positive emitter-coupled logic
LV TTL	low-voltage transistor-transistor logic
OE	output enable
RMS	root mean square
TSSOP	thin shrunk small outline package

Document Conventions

Units of Measure

Symbol	Unit of Measure
°C	degree Celsius
dBc	decibels relative to the carrier
GHz	gigahertz
Hz	hertz
kΩ	kilohm
MHz	megahertz
μA	microampere
μF	microfarad
μs	microsecond
mA	milliampere
ms	millisecond
mV	millivolt
ns	nanosecond
Ω	ohm
pF	picofarad
ps	picosecond
V	volt
W	watt

Document History Page

Document Title: CY2DL1504, 1:4 Differential LVDS Fanout Buffer with Selectable Clock Input				
Document Number: 001-56312				
Revision	ECN	Orig. of Change	Submission Date	Description of Change
**	2782891	CXQ	10/09/09	New data sheet.
*A	2838613	CXQ	01/05/2010	<p>Changed status from Advance to Preliminary.</p> <p>Changed from 0.34 ps to 0.25 ps maximum additive jitter in "Features" on page 1 and in t_{JIT} in the AC Electrical Specs table on page 5.</p> <p>Added t_{PU} spec to the Operating Conditions table on page 3.</p> <p>Changed max I_{DD} spec in the DC Electrical Specs table on page 4 from 60 mA to 61 mA.</p> <p>Removed V_{OD} and ΔV_{OD} specs from the DC Electrical Specs table on page 4.</p> <p>Changed I_{OZ} in the DC Electrical Specs table on page 4 from min of -10 uA to -15 uA and from max of 10 uA to 15 uA.</p> <p>Added R_P spec in the DC Electrical Specs table on page 4. Min = 60 kΩ, Max = 140 kΩ.</p> <p>Added a measurement definition for C_{IN} in the DC Electrical Specs table on page 4.</p> <p>Added V_{PP} and ΔV_{PP} specs to the AC Electrical Specs table on page 5. V_{PP} min = 250 mV and max = 470 mV; ΔV_{PP} max = 50 mV.</p> <p>Changed letter case and some names of all the timing parameters in the AC Electrical Specs table on page 5 to be consistent with EROS.</p> <p>Lowered all additive phase noise mask specs by 3 dB in the AC Electrical Specs table on page 5.</p> <p>Added condition to t_R and t_F specs in the AC Electrical specs table on page 5 that input rise/fall time must be less than 1.5 ns (20% to 80%).</p> <p>Changed letter case and some names of all the timing parameters in Figures 4, 5, 6, 7 and 9, to be consistent with EROS. Updated Figure 4 with definition for V_{PP} and ΔV_{PP}.</p>
*B	3010332	CXQ	08/18/2010	<p>Changed from 0.25 ps to 0.11 ps maximum additive jitter in "Features" on page 1 and in t_{JIT} in the AC Electrical Specs table on page 5.</p> <p>Added "Functional equivalent to ICS8543i" to the "Features" section.</p> <p>Changed pin 13 in Figure 1 and Table 1 from V_{DD} to V_{SS}.</p> <p>Changed pin 8 description in Table 1 from "high impedance" to "disabled".</p> <p>Added note 6 to describe I_{IH} and I_{IL} specs.</p> <p>Removed reference to data distribution from "Functional Description".</p> <p>Changed R_P for diff inputs from 100 kΩ to 150 kΩ in the Logic Block Diagram and from 60 kΩ min / 140 kΩ max to 90 kΩ min / 210 kΩ max in the DC Electrical Specs table.</p> <p>Split V_{ID} into separate specs in DC Electrical Specs table: 0.4 V min and 0.8 V max for LVDS, 0.4 V min and 1.0 V max for LVPECL.</p> <p>Updated phase noise specs for 1 k/10 k/100 k/1 M/10 M/20 MHz offset to -120/-130/-135/-150/-150/-150dBc/Hz, respectively, in the AC Electrical Specs table.</p> <p>Added "Frequency range up to 1 GHz" condition to t_{ODC} spec.</p> <p>Changed t_{OD} in the AC Electrical Specs table from 3 ns max to 5 ns max.</p> <p>Added Acronyms and Ordering Code Definition.</p>

Document History Page (continued)

Document Title: CY2DL1504, 1:4 Differential LVDS Fanout Buffer with Selectable Clock Input				
Document Number: 001-56312				
Revision	ECN	Orig. of Change	Submission Date	Description of Change
*C	3090644	CXQ	11/19/2010	<p>Changed V_{IN} and V_{OUT} specs from 4.0V to "lesser of 4.0 or $V_{DD} + 0.4$"</p> <p>Removed 200mA min LU spec, replaced with "Meets or exceeds JEDEC Spec JESD78B IC Latchup Test"</p> <p>Added "$V_{OUT} = 0.75V - 1.75V$" to I_{OZ} comments.</p> <p>Moved V_{PP} from AC spec table to DC spec table, removed ΔV_{PP}.</p> <p>Removed R_P spec for differential input clock pins IN_X and $IN_{X\#}$.</p> <p>Changed C_{IN} condition to "Measured at 10 MHz".</p> <p>Changed PN_{ADD} specs for 10kHz, 10MHz, and 20MHz offsets.</p> <p>Added "Measured at 1 GHz" to t_R, t_F spec condition.</p> <p>Removed specs t_S, t_H, t_{OD}, and t_{OE} from AC spec table.</p> <p>Removed ΔV_{PP} reference from Figure 4.</p>
*D	3135189	CXQ	01/12/2011	<p>Changed status from Preliminary to Final.</p> <p>Removed "Functional equivalent" bullet on page 1.</p> <p>Added "(see I_{OZ})" note to pin 8 description in Pin Definitions.</p> <p>Fixed typo and removed resistors from $IN_X/IN_{X\#}$ in Logic Block Diagram.</p> <p>Added Figure 10 to describe T_{SOE} and T_{SOD}.</p>
*E	3090938	CXQ	02/25/11	Post to external web.
*F	3208968	CXQ	03/29/2011	Changed R_P max from 140 k Ω to 165 k Ω and updated R_P in Logic Block Diagram .
*G	3308039	CXQ	07/11/2011	Updated supported differential input clock types to include CML in Features , Functional Description , Pin Definitions , and DC specs table sections.
*H	3395868	PURU	10/05/11	<p>Updated supported differential input clock types to include HCSL in Features, Pinouts, and DC Electrical Specifications table.</p> <p>Changed Min value of V_{ICM}.</p>
*I	3892255	PURU	02/01/2013	<p>Updated Features (Added "Translates any single-ended input signal to 3.3 V LVPECL levels with resistor bias on $IN_{X\#}$ input").</p> <p>Updated AC Electrical Specifications:</p> <p>Added Note 9 and Note 14.</p> <p>Added F_{IN} parameter values for "Single Ended Input" condition (Minimum value = DC, Maximum value = 250 MHz).</p> <p>Added F_{OUT} parameter values for "Single Ended Input" condition (Minimum value = DC, Maximum value = 250 MHz).</p> <p>Added t_{ODC} parameter values for "Single Ended Input" condition (Minimum value = 45%, Maximum value = 55%).</p> <p>Updated Description of PN_{ADD} parameter (Replaced "Additive RMS phase noise, 156.25-MHz input, Rise/fall time < 150 ps (20% to 80%), $V_{ID} > 400$ mV" with "Additive RMS phase noise, 156.25-MHz input, Rise/fall time < 150 ps (20% to 80%), $V_{ID} > 400$ mV or Input Swing = 3.0 V^[9]").</p> <p>Added t_{JIT} parameter values for the Condition "156.25 MHz Sinewave, 12 kHz to 20 MHz offset, input rise/fall time < 150 ps (20% to 80%), Input Swing = 3.0 V^[14]" (Maximum value = 0.11 ps).</p> <p>Added Application Information.</p> <p>Updated to new template.</p>
*J	4587249	PURU	12/04/2014	<p>Updated Functional Description:</p> <p>Added "For a complete list of related documentation, click here." at the end.</p> <p>Updated Package Diagram:</p> <p>spec 51-85118 – Changed revision from *D to *E.</p>
*K	5267558	PSR	05/13/2016	<p>Added Thermal Resistance.</p> <p>Updated to new template.</p>
*L	5962077	AESATMP8	11/09/2017	Updated logo and Copyright.

Sales, Solutions, and Legal Information

Worldwide Sales and Design Support

Cypress maintains a worldwide network of offices, solution centers, manufacturer's representatives, and distributors. To find the office closest to you, visit us at [Cypress Locations](#).

Products

ARM [®] Cortex [®] Microcontrollers	cypress.com/arm
Automotive	cypress.com/automotive
Clocks & Buffers	cypress.com/clocks
Interface	cypress.com/interface
Internet of Things	cypress.com/iot
Memory	cypress.com/memory
Microcontrollers	cypress.com/mcu
PSoC	cypress.com/psoc
Power Management ICs	cypress.com/pmic
Touch Sensing	cypress.com/touch
USB Controllers	cypress.com/usb
Wireless Connectivity	cypress.com/wireless

PSoC[®] Solutions

[PSoC 1](#) | [PSoC 3](#) | [PSoC 4](#) | [PSoC 5LP](#) | [PSoC 6](#)

Cypress Developer Community

[Forums](#) | [WICED IOT Forums](#) | [Projects](#) | [Video](#) | [Blogs](#) | [Training](#) | [Components](#)

Technical Support

cypress.com/support

© Cypress Semiconductor Corporation, 2009-2017. This document is the property of Cypress Semiconductor Corporation and its subsidiaries, including Spansion LLC ("Cypress"). This document, including any software or firmware included or referenced in this document ("Software"), is owned by Cypress under the intellectual property laws and treaties of the United States and other countries worldwide. Cypress reserves all rights under such laws and treaties and does not, except as specifically stated in this paragraph, grant any license under its patents, copyrights, trademarks, or other intellectual property rights. If the Software is not accompanied by a license agreement and you do not otherwise have a written agreement with Cypress governing the use of the Software, then Cypress hereby grants you a personal, non-exclusive, nontransferable license (without the right to sublicense) (1) under its copyright rights in the Software (a) for Software provided in source code form, to modify and reproduce the Software solely for use with Cypress hardware products, only internally within your organization, and (b) to distribute the Software in binary code form externally to end users (either directly or indirectly through resellers and distributors), solely for use on Cypress hardware product units, and (2) under those claims of Cypress's patents that are infringed by the Software (as provided by Cypress, unmodified) to make, use, distribute, and import the Software solely for use with Cypress hardware products. Any other use, reproduction, modification, translation, or compilation of the Software is prohibited.

TO THE EXTENT PERMITTED BY APPLICABLE LAW, CYPRESS MAKES NO WARRANTY OF ANY KIND, EXPRESS OR IMPLIED, WITH REGARD TO THIS DOCUMENT OR ANY SOFTWARE OR ACCOMPANYING HARDWARE, INCLUDING, BUT NOT LIMITED TO, THE IMPLIED WARRANTIES OF MERCHANTABILITY AND FITNESS FOR A PARTICULAR PURPOSE. To the extent permitted by applicable law, Cypress reserves the right to make changes to this document without further notice. Cypress does not assume any liability arising out of the application or use of any product or circuit described in this document. Any information provided in this document, including any sample design information or programming code, is provided only for reference purposes. It is the responsibility of the user of this document to properly design, program, and test the functionality and safety of any application made of this information and any resulting product. Cypress products are not designed, intended, or authorized for use as critical components in systems designed or intended for the operation of weapons, weapons systems, nuclear installations, life-support devices or systems, other medical devices or systems (including resuscitation equipment and surgical implants), pollution control or hazardous substances management, or other uses where the failure of the device or system could cause personal injury, death, or property damage ("Unintended Uses"). A critical component is any component of a device or system whose failure to perform can be reasonably expected to cause the failure of the device or system, or to affect its safety or effectiveness. Cypress is not liable, in whole or in part, and you shall and hereby do release Cypress from any claim, damage, or other liability arising from or related to all Unintended Uses of Cypress products. You shall indemnify and hold Cypress harmless from and against all claims, costs, damages, and other liabilities, including claims for personal injury or death, arising from or related to any Unintended Uses of Cypress products.

Cypress, the Cypress logo, Spansion, the Spansion logo, and combinations thereof, WICED, PSoC, CapSense, EZ-USB, F-RAM, and Traveo are trademarks or registered trademarks of Cypress in the United States and other countries. For a more complete list of Cypress trademarks, visit cypress.com. Other names and brands may be claimed as property of their respective owners.

X-ON Electronics

Largest Supplier of Electrical and Electronic Components

Click to view similar products for [Clock Drivers & Distribution](#) category:

Click to view products by [Cypress](#) manufacturer:

Other Similar products are found below :

[8501BYLF](#) [P9090-0NLGI8](#) [854110AKILF](#) [83210AYLF](#) [NB6VQ572MMNG](#) [4RCD0232KC1ATG](#) [6ES7390-1AF30-0AA0](#)
[CDCVF2505IDRQ1](#) [NB7L572MNR4G](#) [SY100EP33VKG](#) [HMC7043LP7FETR](#) [ISPPAC-CLK5520V-01T100C](#) [EC4P-221-MRXD1](#)
[6EP1332-1SH71](#) [AD246JN](#) [AD246JY](#) [AD9508SCPZ-EP](#) [AD9510BCPZ](#) [AD9510BCPZ-REEL7](#) [AD9511BCPZ](#) [AD9511BCPZ-REEL7](#)
[AD9512BCPZ](#) [AD9512UCPZ-EP](#) [AD9514BCPZ](#) [AD9514BCPZ-REEL7](#) [AD9515BCPZ](#) [AD9515BCPZ-REEL7](#) [AD9572ACPZLVD](#)
[AD9572ACPZPEC](#) [AD9513BCPZ-REEL7](#) [AD9553BCPZ](#) [HMC940LC4B](#) [CSPUA877ABVG8](#) [9P936AFLFT](#) [49FCT805CTQG](#)
[74FCT3807EQGI](#) [74FCT388915TEPYG](#) [853S013AMILF](#) [853S058AGILF](#) [8V79S680NLGI](#) [ISPPAC-CLK5312S-01TN48I](#) [ISPPAC-](#)
[CLK5520V-01TN100I](#) [ISPPAC-CLK5510V-01TN48C](#) [83905AMLFT](#) [8S73034AMILF](#) [8538BG-31LF](#) [49FCT805BTPYG](#)
[49FCT20805PYGI](#) [MAX9320BEUA+](#) [MAX9325EQI](#)