

## 4-Mbit (256K words × 16-bit) Static RAM with Error-Correcting Code (ECC)

### Features

- High speed: 45 ns/55 ns
- Ultra-low standby power
  - Typical standby current: 3.5  $\mu$ A
  - Maximum standby current: 8.7  $\mu$ A
- Embedded ECC for single-bit error correction<sup>[1, 2]</sup>
- Wide voltage range: 1.65 V to 2.2 V, 2.2 V to 3.6 V, and 4.5 V to 5.5 V
- 1.0-V data retention
- TTL-compatible inputs and outputs
- Error indication (ERR) pin to indicate 1-bit error detection and correction
- Pb-free 48-ball VFBGA and 44-pin TSOP II packages

### Functional Description

CY62147G and CY62147GE are high-performance CMOS low-power (MoBL) SRAM devices with embedded ECC. Both devices are offered in single and dual chip enable options and in multiple pin configurations. The CY62147GE device includes an ERR pin that signals an error-detection and correction event during a read cycle.

Devices with a single chip enable input are accessed by asserting the chip enable ( $\overline{CE}$ ) input LOW. Dual chip enable devices are accessed by asserting both chip enable inputs –  $\overline{CE}_1$  as low and  $CE_2$  as HIGH.

Data writes are performed by asserting the Write Enable ( $\overline{WE}$ ) input LOW, while providing the data on I/O<sub>0</sub> through I/O<sub>15</sub> and address on A<sub>0</sub> through A<sub>17</sub> pins. The Byte High Enable ( $\overline{BHE}$ ) and Byte Low Enable ( $\overline{BLE}$ ) inputs control write operations to the upper and lower bytes of the specified memory location.  $\overline{BHE}$  controls I/O<sub>8</sub> through I/O<sub>15</sub> and  $\overline{BLE}$  controls I/O<sub>0</sub> through I/O<sub>7</sub>.

Data reads are performed by asserting the Output Enable ( $\overline{OE}$ ) input and providing the required address on the address lines. Read data is accessible on the I/O lines (I/O<sub>0</sub> through I/O<sub>15</sub>). Byte accesses can be performed by asserting the required byte enable signal ( $\overline{BHE}$  or  $\overline{BLE}$ ) to read either the upper byte or the lower byte of data from the specified address location.

All I/Os (I/O<sub>0</sub> through I/O<sub>15</sub>) are placed in a HI-Z state when the device is deselected ( $\overline{CE}$  HIGH for a single chip enable device and  $\overline{CE}_1$  HIGH/ $CE_2$  LOW for a dual chip enable device), or control signals are de-asserted ( $\overline{OE}$ ,  $\overline{BLE}$ ,  $\overline{BHE}$ ).

The device also has a unique Byte Power down feature, where, if both the Byte Enables ( $\overline{BHE}$  and  $\overline{BLE}$ ) are disabled, the devices seamlessly switch to standby mode irrespective of the state of the chip enables, thereby saving power.

On the CY62147GE devices, the detection and correction of a single-bit error in the accessed location is indicated by the assertion of the ERR output (ERR = HIGH)<sup>[1]</sup>. See the [Truth Table – CY62147G/CY62147GE on page 16](#) for a complete description of read and write modes.

The logic block diagrams are on page 2.

### Product Portfolio

Product <sup>[3]</sup>	Features and Options (see the Pin Configurations section)	Range	V <sub>CC</sub> Range (V)	Speed (ns)	Power Dissipation			
					Operating I <sub>CC</sub> (mA)		Standby, I <sub>SB2</sub> ( $\mu$ A)	
					f = f <sub>max</sub>			
					Typ <sup>[4]</sup>	Max	Typ <sup>[4]</sup>	Max
CY62147G(E)18	Single or dual Chip Enables	Industrial	1.65 V–2.2 V	55	15	20	3.5	10
CY62147G(E)30 CY621472G30			2.2 V–3.6 V	45	15	20	3.5	8.7
CY62147G(E)	Optional ERR pin		4.5 V–5.5 V					

#### Notes

1. This device does not support automatic write-back on error detection.
2. SER FIT Rate <0.1 FIT/Mb. Refer [AN88889](#) for details.
3. The ERR pin is available only for devices which have ERR option "E" in the ordering code. Refer [Ordering Information on page 17](#).
4. Typical values are included for reference only and are not guaranteed or tested. Typical values are measured at V<sub>CC</sub> = 1.8 V (for a V<sub>CC</sub> range of 1.65 V–2.2 V), V<sub>CC</sub> = 3 V (for V<sub>CC</sub> range of 2.2 V–3.6 V), and V<sub>CC</sub> = 5 V (for V<sub>CC</sub> range of 4.5 V–5.5 V), T<sub>A</sub> = 25 °C.

**Logic Block Diagram – CY62147G**

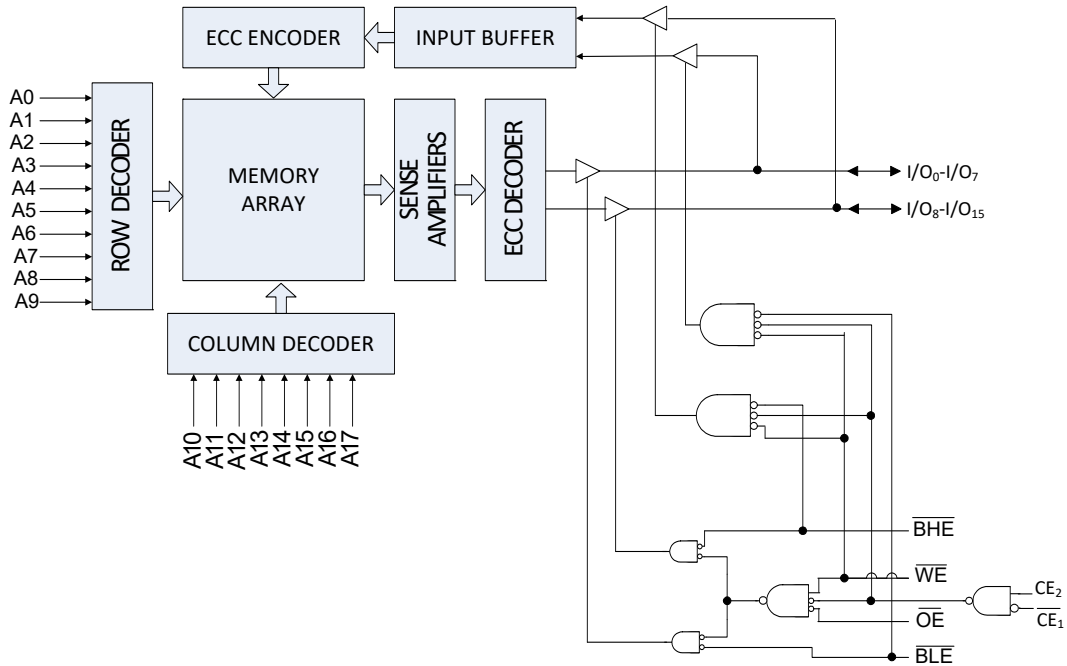

**Logic Block Diagram – CY62147GE**

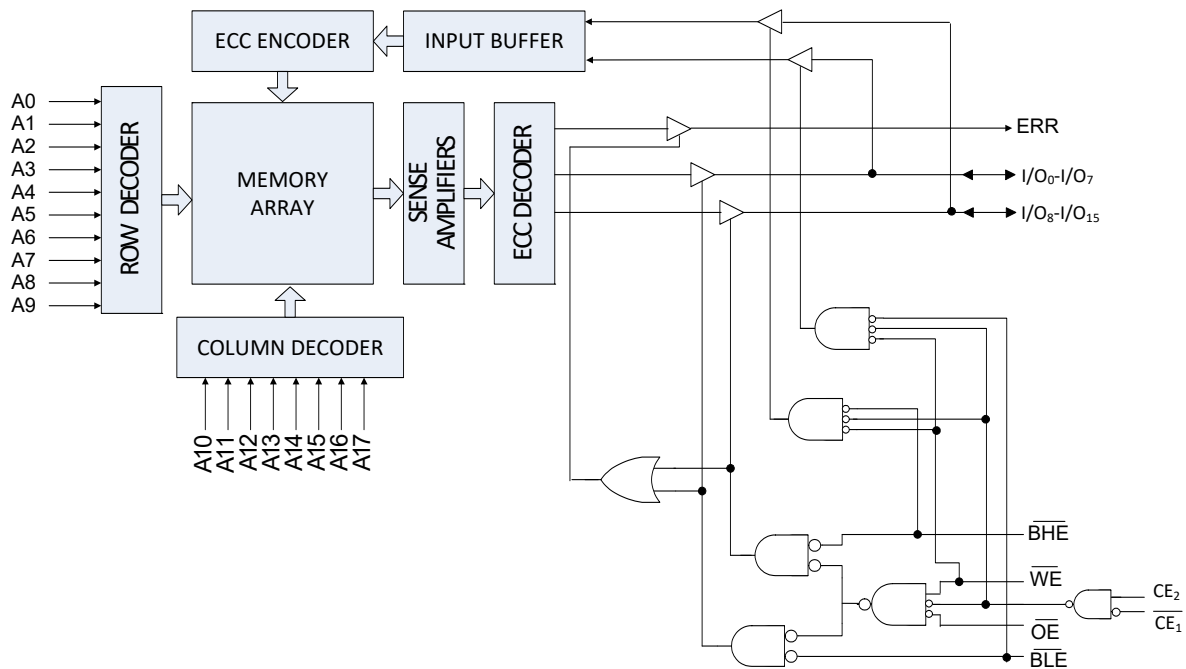

## Contents

<b>Pin Configuration – CY62147G</b> .....	<b>4</b>	<b>Ordering Information</b> .....	<b>17</b>
<b>Pin Configuration – CY62147GE</b> .....	<b>5</b>	Ordering Code Definitions .....	18
<b>Pin Configuration – CY621472G</b> .....	<b>6</b>	<b>Package Diagrams</b> .....	<b>19</b>
<b>Maximum Ratings</b> .....	<b>7</b>	<b>Acronyms</b> .....	<b>20</b>
<b>Operating Range</b> .....	<b>7</b>	<b>Document Conventions</b> .....	<b>20</b>
<b>DC Electrical Characteristics</b> .....	<b>7</b>	Units of Measure .....	20
<b>Capacitance</b> .....	<b>9</b>	<b>Document History Page</b> .....	<b>21</b>
<b>Thermal Resistance</b> .....	<b>9</b>	<b>Sales, Solutions, and Legal Information</b> .....	<b>22</b>
<b>AC Test Loads and Waveforms</b> .....	<b>9</b>	Worldwide Sales and Design Support .....	22
<b>Data Retention Characteristics</b> .....	<b>10</b>	Products .....	22
<b>Data Retention Waveform</b> .....	<b>10</b>	PSoC <sup>®</sup> Solutions .....	22
<b>AC Switching Characteristics</b> .....	<b>11</b>	Cypress Developer Community .....	22
<b>Switching Waveforms</b> .....	<b>12</b>	Technical Support .....	22
<b>Truth Table – CY62147G/CY62147GE</b> .....	<b>16</b>		
<b>ERR Output – CY62147GE</b> .....	<b>16</b>		

### Pin Configuration – CY62147G

Figure 1. 48-ball VFBGA pinout (Dual Chip Enable without ERR), CY62147G [5]

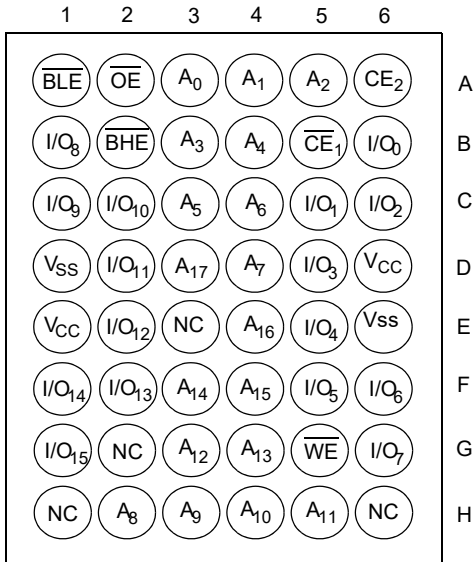

Figure 2. 48-ball VFBGA pinout (Single Chip Enable without ERR), CY62147G [5]

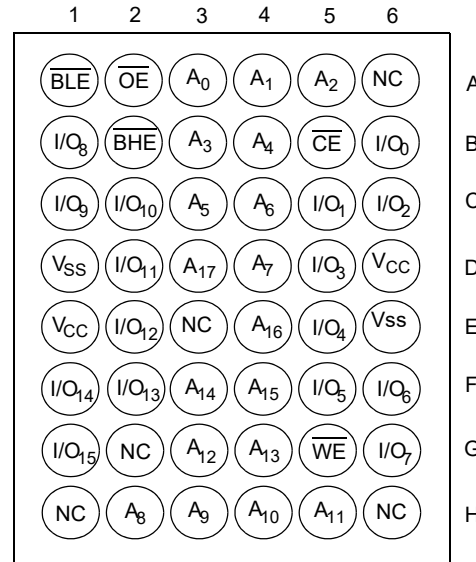
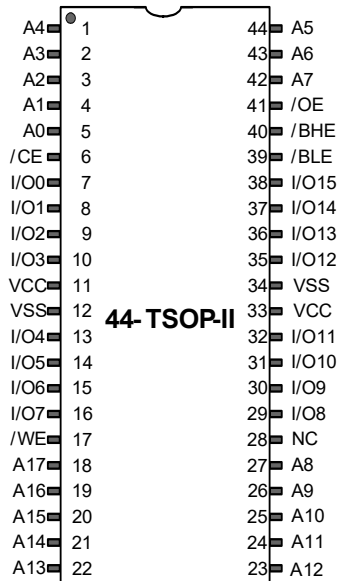

Figure 3. 44-pin TSOP II pinout (Single Chip Enable without ERR), CY62147G [5]



**Notes**

5. NC pins are not connected internally to the die and are typically used for address expansion to a higher-density device. Refer to the respective datasheets for pin configuration.

### Pin Configuration – CY62147GE

**Figure 4. 48-ball VFBGA pinout (Dual Chip Enable with ERR), CY62147GE** [6, 7]

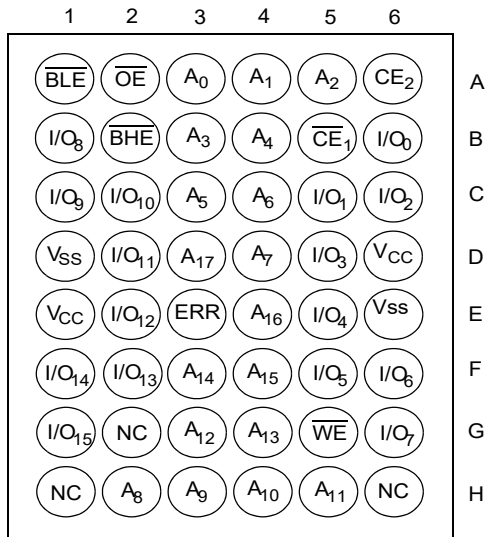

**Figure 5. 48-ball VFBGA pinout (Single Chip Enable with ERR), CY62147GE** [6, 7]

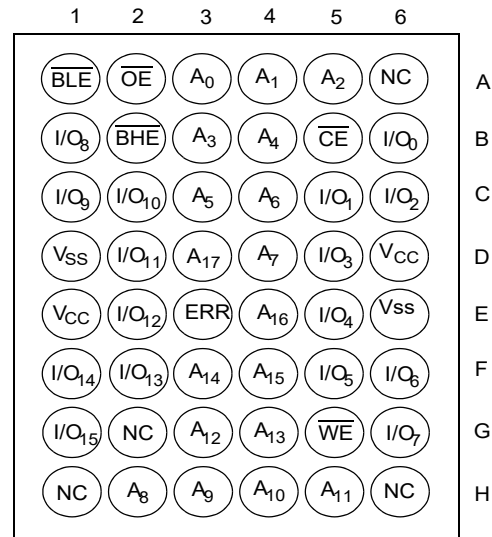

**Figure 6. 44-pin TSOP II pinout (Single Chip Enable with ERR), CY62147GE** [6, 7]

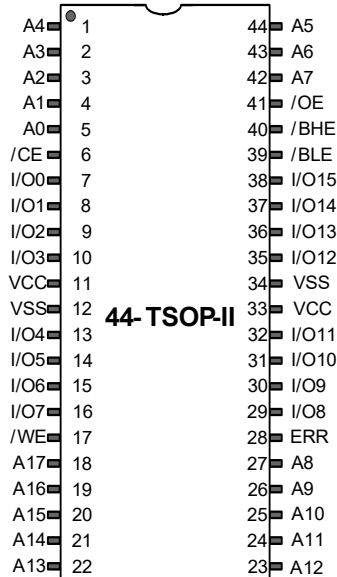

**Notes**

- 6. NC pins are not connected internally to the die and are typically used for address expansion to a higher-density device. Refer to the respective datasheets for pin configuration.
- 7. ERR is an output pin.

## Pin Configuration – CY621472G

Figure 7. 44-pin TSOP II pinout (Dual Chip Enable without ERR), CY621472G

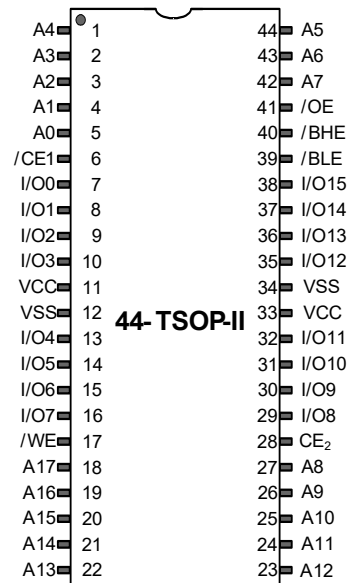

## Maximum Ratings

Exceeding maximum ratings may shorten the useful life of the device. User guidelines are not tested.

Storage temperature ..... -65 °C to + 150 °C

Ambient temperature  
with power applied ..... -55 °C to + 125 °C

Supply voltage  
to ground potential <sup>[8]</sup> ..... -0.5 V to V<sub>CC</sub> + 0.5 V

DC voltage applied to outputs  
in HI-Z state <sup>[8]</sup> ..... -0.5 V to V<sub>CC</sub> + 0.5 V

DC input voltage <sup>[8]</sup> ..... -0.5 V to V<sub>CC</sub> + 0.5 V

Output current into outputs (in low state) ..... 20 mA

Static discharge voltage  
(MIL-STD-883, Method 3015) ..... >2001 V

Latch-up current ..... >140 mA

## Operating Range

Grade	Ambient Temperature	V <sub>CC</sub>
Industrial	-40 °C to +85 °C	1.65 V to 2.2 V, 2.2 V to 3.6 V, 4.5 V to 5.5 V

## DC Electrical Characteristics

Over the operating range of -40 °C to 85 °C

Parameter	Description	Test Conditions	45 ns / 55 ns			Unit	
			Min	Typ	Max		
V <sub>OH</sub>	Output HIGH voltage	1.65 V to 2.2 V	V <sub>CC</sub> = Min, I <sub>OH</sub> = -0.1 mA	1.4	-	-	V
		2.2 V to 2.7 V	V <sub>CC</sub> = Min, I <sub>OH</sub> = -0.1 mA	2	-	-	
		2.7 V to 3.6 V	V <sub>CC</sub> = Min, I <sub>OH</sub> = -1.0 mA	2.4	-	-	
		4.5 V to 5.5 V	V <sub>CC</sub> = Min, I <sub>OH</sub> = -1.0 mA	2.4	-	-	
		4.5 V to 5.5 V	V <sub>CC</sub> = Min, I <sub>OH</sub> = -0.1 mA	V <sub>CC</sub> - 0.5 <sup>[9]</sup>	-	-	
V <sub>OL</sub>	Output LOW voltage	1.65 V to 2.2 V	V <sub>CC</sub> = Min, I <sub>OL</sub> = 0.1 mA	-	-	0.2	V
		2.2 V to 2.7 V	V <sub>CC</sub> = Min, I <sub>OL</sub> = 0.1 mA	-	-	0.4	
		2.7 V to 3.6 V	V <sub>CC</sub> = Min, I <sub>OL</sub> = 2.1 mA	-	-	0.4	
		4.5 V to 5.5 V	V <sub>CC</sub> = Min, I <sub>OL</sub> = 2.1 mA	-	-	0.4	
V <sub>IH</sub>	Input HIGH voltage	1.65 V to 2.2 V	-	1.4	-	V <sub>CC</sub> + 0.2 <sup>[8]</sup>	V
		2.2 V to 2.7 V	-	1.8	-	V <sub>CC</sub> + 0.3 <sup>[8]</sup>	
		2.7 V to 3.6 V	-	2	-	V <sub>CC</sub> + 0.3 <sup>[8]</sup>	
		4.5 V to 5.5 V	-	2.2	-	V <sub>CC</sub> + 0.5 <sup>[8]</sup>	
V <sub>IL</sub>	Input LOW voltage	1.65 V to 2.2 V	-	-0.2 <sup>[8]</sup>	-	0.4	V
		2.2 V to 2.7 V	-	-0.3 <sup>[8]</sup>	-	0.6	
		2.7 V to 3.6 V	-	-0.3 <sup>[8]</sup>	-	0.8	
		4.5 V to 5.5 V	-	-0.5 <sup>[8]</sup>	-	0.8	
I <sub>IX</sub>	Input leakage current	GND ≤ V <sub>IN</sub> ≤ V <sub>CC</sub>	-1	-	+1	μA	
I <sub>OZ</sub>	Output leakage current	GND ≤ V <sub>OUT</sub> ≤ V <sub>CC</sub> , Output disabled	-1	-	+1	μA	
I <sub>CC</sub>	V <sub>CC</sub> operating supply current	Max V <sub>CC</sub> , I <sub>OUT</sub> = 0 mA, CMOS levels	f = 22.22 MHz (45 ns)	-	15	20	mA
			f = 18.18 MHz (55 ns)	-	15	20	mA
			f = 1 MHz	-	3.5	6	mA

### Notes

8. V<sub>IL(min)</sub> = -2.0 V and V<sub>IH(max)</sub> = V<sub>CC</sub> + 2 V for pulse durations of less than 20 ns.

9. This parameter is guaranteed by design and not tested.

## DC Electrical Characteristics (continued)

Over the operating range of -40 °C to 85 °C

Parameter	Description	Test Conditions	45 ns / 55 ns			Unit	
			Min	Typ	Max		
$I_{SB1}^{[10]}$	Automatic power down current – CMOS inputs; $V_{CC} = 2.2\text{ V to }3.6\text{ V and }4.5\text{ V to }5.5\text{ V}$	$\overline{CE}_1 \geq V_{CC} - 0.2\text{ V or }CE_2 \leq 0.2\text{ V},$ $(\overline{BHE} \text{ and } \overline{BLE}) \geq V_{CC} - 0.2\text{ V},$	–	3.5	8.7	$\mu\text{A}$	
	Automatic power down current – CMOS inputs $V_{CC} = 1.65\text{ V to }2.2\text{ V}$	$V_{IN} \geq V_{CC} - 0.2\text{ V}, V_{IN} \leq 0.2\text{ V},$ $f = f_{max}$ (address and data only), $f = 0$ ( $\overline{OE}$ , and $\overline{WE}$ ), Max $V_{CC}$	–	–	10		
$I_{SB2}^{[10]}$	Automatic power down current – CMOS inputs $V_{CC} = 2.2\text{ V to }3.6\text{ V and }4.5\text{ V to }5.5\text{ V}$	$\overline{CE}_1 \geq V_{CC} - 0.2\text{V or }CE_2 \leq 0.2\text{ V},$ $(\overline{BHE} \text{ and } \overline{BLE}) \geq V_{CC} - 0.2\text{ V},$ $V_{IN} \geq V_{CC} - 0.2\text{ V or }V_{IN} \leq 0.2\text{ V},$ $f = 0, \text{ Max } V_{CC}$	25 °C [11]	–	3.5	3.7	$\mu\text{A}$
			40 °C [11]	–	–	4.8	
			70 °C [11]	–	–	7	
			85 °C	–	–	8.7	
	Automatic power down current – CMOS inputs $V_{CC} = 1.65\text{ V to }2.2\text{ V}$	$\overline{CE}_1 \geq V_{CC} - 0.2\text{V or }CE_2 \leq 0.2\text{ V or }(\overline{BHE} \text{ and } \overline{BLE}) \geq V_{CC} - 0.2\text{ V},$ $V_{IN} \geq V_{CC} - 0.2\text{ V or }V_{IN} \leq 0.2\text{ V},$ $f = 0, \text{ Max } V_{CC}$	25 °C [11]	–	3.5	4.3	
			40 °C [11]	–	–	5	
			70 °C [11]	–	–	7.5	
			85 °C	–	–	10	

### Notes

10. Chip enables ( $\overline{CE}_1$  and  $CE_2$ ) must be tied to CMOS levels to meet the  $I_{SB1} / I_{SB2} / I_{CCDR}$  spec. Other inputs can be left floating.  
11. The  $I_{SB2}$  limits at 25 °C, 40 °C, 70 °C, and typical limit at 85 °C are guaranteed by design and not 100% tested.



## Capacitance

Parameter <sup>[12]</sup>	Description	Test Conditions	Max	Unit
C <sub>IN</sub>	Input capacitance	T <sub>A</sub> = 25 °C, f = 1 MHz, V <sub>CC</sub> = V <sub>CC(typ)</sub>	10	pF
C <sub>OUT</sub>	Output capacitance		10	pF

## Thermal Resistance

Parameter <sup>[12]</sup>	Description	Test Conditions	48-ball VFBGA	44-pin TSOP II	Unit
Θ <sub>JA</sub>	Thermal resistance (junction to ambient)	Still air, soldered on a 3 × 4.5 inch, four-layer printed circuit board	31.35	68.85	°C/W
Θ <sub>JC</sub>	Thermal resistance (junction to case)		14.74	15.97	°C/W

## AC Test Loads and Waveforms

Figure 8. AC Test Loads and Waveforms<sup>[13]</sup>

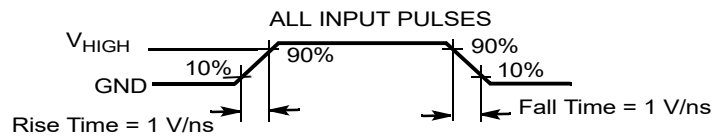
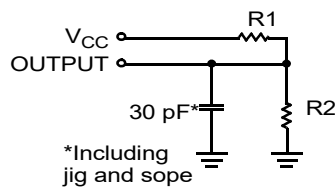

Equivalent to: THÉVENIN EQUIVALENT

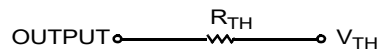

Parameters	1.8 V	2.5 V	3.0 V	5.0 V	Unit
R <sub>1</sub>	13500	16667	1103	1800	Ω
R <sub>2</sub>	10800	15385	1554	990	Ω
R <sub>TH</sub>	6000	8000	645	639	Ω
V <sub>TH</sub>	0.80	1.20	1.75	1.77	V

### Notes

12. Tested initially and after any design or process changes that may affect these parameters.
13. Full-device operation requires linear V<sub>CC</sub> ramp from V<sub>DR</sub> to V<sub>CC(min)</sub> ≥ 100 μs or stable at V<sub>CC(min)</sub> ≥ 100 μs.

## Data Retention Characteristics

Over the Operating range

Parameter	Description	Conditions	Min	Typ <sup>[14]</sup>	Max	Unit
$V_{DR}$	$V_{CC}$ for data retention		1	–	–	V
$I_{CCDR}$ <sup>[15, 16]</sup>	Data retention current	$V_{CC} = 1.2\text{ V}$ $\overline{CE}_1 \geq V_{CC} - 0.2\text{ V}$ or $CE_2 \leq 0.2\text{ V}$ or $(\overline{BHE}$ and $\overline{BLE}) \geq V_{CC} - 0.2\text{ V}$ , $V_{IN} \geq V_{CC} - 0.2\text{ V}$ or $V_{IN} \leq 0.2\text{ V}$	–	–	13	$\mu\text{A}$
$t_{CDR}$ <sup>[17]</sup>	Chip deselect to data retention time		0	–	–	ns
$t_R$ <sup>[18]</sup>	Operation recovery time		45/55	–	–	ns

## Data Retention Waveform

Figure 9. Data Retention Waveform<sup>[19]</sup>

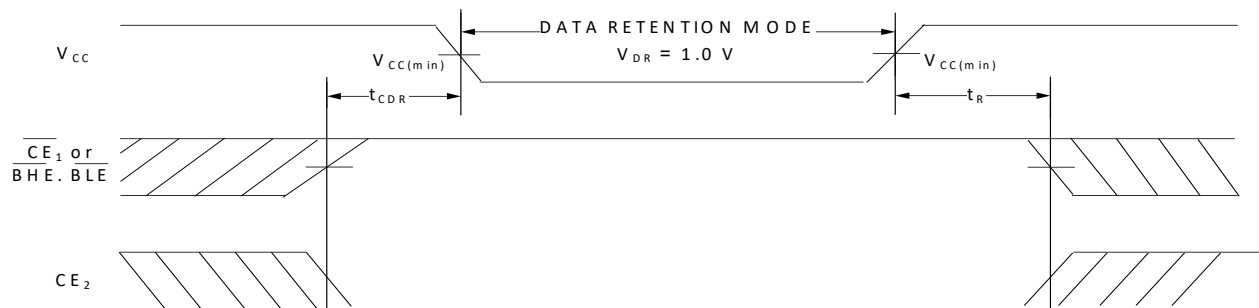

### Notes

14. Typical values are included only for reference and are not guaranteed or tested. Typical values are measured at  $V_{CC} = 1.8\text{ V}$  (for  $V_{CC}$  range of 1.65 V–2.2 V),  $V_{CC} = 3\text{ V}$  (for  $V_{CC}$  range of 2.2 V–3.6 V), and  $V_{CC} = 5\text{ V}$  (for  $V_{CC}$  range of 4.5 V–5.5 V),  $T_A = 25\text{ }^\circ\text{C}$ .
15. Chip enables ( $\overline{CE}_1$  and  $CE_2$ ) must be tied to CMOS levels to meet the  $I_{SB1} / I_{SB2} / I_{CCDR}$  spec. Other inputs can be left floating.
16.  $I_{CCDR}$  is guaranteed only after device is first powered up to  $V_{CC(min)}$  and then brought down to  $V_{DR}$ .
17. These parameters are guaranteed by design.
18. Full-device operation requires linear  $V_{CC}$  ramp from  $V_{DR}$  to  $V_{CC(min)} \geq 100\text{ }\mu\text{s}$  or stable at  $V_{CC(min)} \geq 100\text{ }\mu\text{s}$ .
19.  $\overline{BHE}.\overline{BLE}$  is the AND of both  $\overline{BHE}$  and  $\overline{BLE}$ . Deselect the chip by either disabling the chip enable signals or by disabling both  $\overline{BHE}$  and  $\overline{BLE}$ .

## AC Switching Characteristics

Parameter <sup>[20, 21]</sup>	Description	45 ns		55 ns		Unit
		Min	Max	Min	Max	
<b>Read Cycle</b>						
$t_{RC}$	Read cycle time	45	–	55	–	ns
$t_{AA}$	Address to data valid / Address to ERR valid	–	45	–	55	ns
$t_{OHA}$	Data hold from address change / ERR hold from address change	10	–	10	–	ns
$t_{ACE}$	$\overline{CE}_1$ LOW and $CE_2$ HIGH to data valid / $\overline{CE}$ LOW to ERR valid	–	45	–	55	ns
$t_{DOE}$	$\overline{OE}$ LOW to data valid / $\overline{OE}$ LOW to ERR valid	–	22	–	25	ns
$t_{LZOE}$	$\overline{OE}$ LOW to Low impedance <sup>[21, 23]</sup>	5	–	5	–	ns
$t_{HZOE}$	$\overline{OE}$ HIGH to HI-Z <sup>[21, 22, 23]</sup>	–	18	–	18	ns
$t_{LZCE}$	$\overline{CE}_1$ LOW and $CE_2$ HIGH to Low impedance <sup>[21, 23]</sup>	10	–	10	–	ns
$t_{HZCE}$	$\overline{CE}_1$ HIGH and $CE_2$ LOW to HI-Z <sup>[21, 22, 23]</sup>	–	18	–	18	ns
$t_{PU}$	$\overline{CE}_1$ LOW and $CE_2$ HIGH to power-up <sup>[23]</sup>	0	–	0	–	ns
$t_{PD}$	$\overline{CE}_1$ HIGH and $CE_2$ LOW to power-down <sup>[23]</sup>	–	45	–	55	ns
$t_{DBE}$	$\overline{BLE}$ / $\overline{BHE}$ LOW to data valid	–	45	–	55	ns
$t_{LZBE}$	$\overline{BLE}$ / $\overline{BHE}$ LOW to Low impedance <sup>[21, 23]</sup>	5	–	5	–	ns
$t_{HZBE}$	$\overline{BLE}$ / $\overline{BHE}$ HIGH to HI-Z <sup>[21, 22, 23]</sup>	–	18	–	18	ns
<b>Write Cycle<sup>[24, 25]</sup></b>						
$t_{WC}$	Write cycle time	45	–	55	–	ns
$t_{SCE}$	$\overline{CE}_1$ LOW and $CE_2$ HIGH to write end	35	–	45	–	ns
$t_{AW}$	Address setup to write end	35	–	45	–	ns
$t_{HA}$	Address hold from write end	0	–	0	–	ns
$t_{SA}$	Address setup to write start	0	–	0	–	ns
$t_{PWE}$	$\overline{WE}$ pulse width	35	–	40	–	ns
$t_{BW}$	$\overline{BLE}$ / $\overline{BHE}$ LOW to write end	35	–	45	–	ns
$t_{SD}$	Data setup to write end	25	–	25	–	ns
$t_{HD}$	Data hold from write end	0	–	0	–	ns
$t_{HZWE}$	$\overline{WE}$ LOW to HI-Z <sup>[21, 22, 23]</sup>	–	18	–	20	ns
$t_{LZWE}$	$\overline{WE}$ HIGH to Low impedance <sup>[21, 23]</sup>	10	–	10	–	ns

### Notes

20. Test conditions assume a signal transition time (rise/fall) of 3 ns or less, timing reference levels of 1.5 V (for  $V_{CC} \geq 3$  V) and  $V_{CC}/2$  (for  $V_{CC} < 3$  V), and input pulse levels of 0 to 3 V (for  $V_{CC} \geq 3$  V) and 0 to  $V_{CC}$  (for  $V_{CC} < 3$  V). Test conditions for the read cycle use output loading shown in AC Test Loads and Waveforms section, unless specified otherwise.
21. At any temperature and voltage condition,  $t_{HZCE}$  is less than  $t_{LZCE}$ ,  $t_{HZBE}$  is less than  $t_{LZBE}$ ,  $t_{HZOE}$  is less than  $t_{LZOE}$ , and  $t_{HZWE}$  is less than  $t_{LZWE}$  for any device.
22.  $t_{HZOE}$ ,  $t_{HZCE}$ ,  $t_{HZBE}$ , and  $t_{HZWE}$  transitions are measured when the outputs enter a high-impedance state.
23. These parameters are guaranteed by design.
24. The internal write time of the memory is defined by the overlap of  $\overline{WE} = V_{IL}$ ,  $\overline{CE}_1 = V_{IL}$ ,  $\overline{BHE}$  or  $\overline{BLE}$ , or both =  $V_{IL}$ , and  $CE_2 = V_{IH}$ . All signals must be ACTIVE to initiate a write and any of these signals can terminate a write by going INACTIVE. The data input setup and hold timing must refer to the edge of the signal that terminates the write.
25. The minimum pulse width in Write Cycle No. 3 ( $\overline{WE}$  Controlled,  $\overline{OE}$  LOW) should be equal to sum of  $t_{SD}$  and  $t_{HZWE}$ .

## Switching Waveforms

Figure 10. Read Cycle No. 1 of CY62147G (Address Transition Controlled) [26, 27]

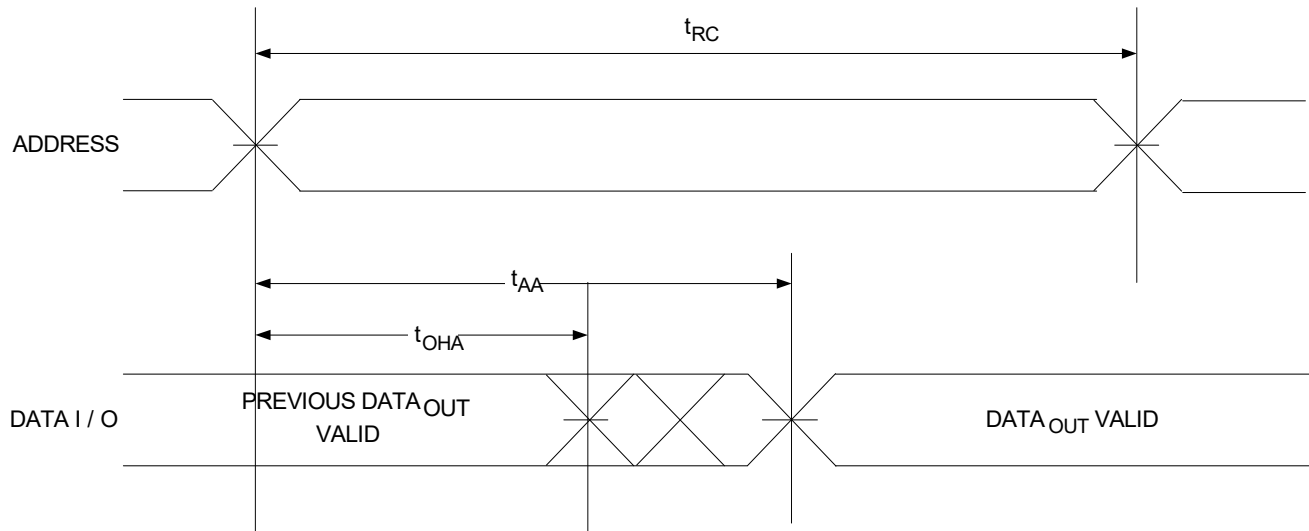
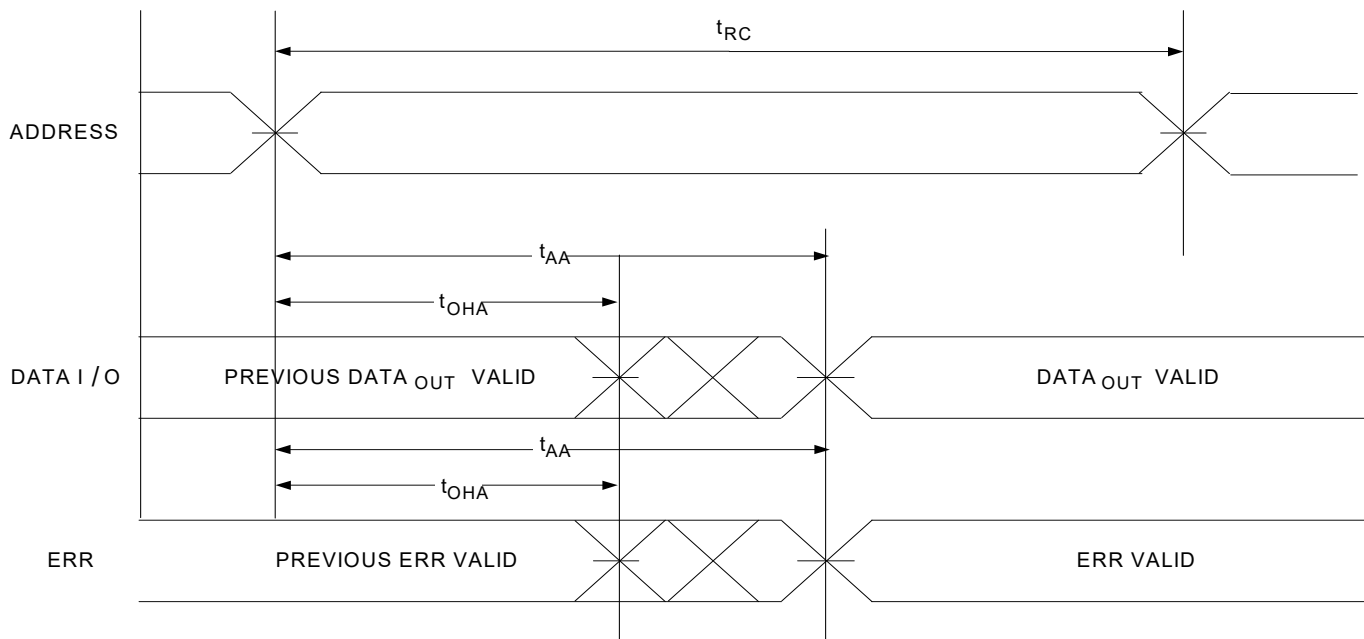

Figure 11. Read Cycle No. 1 of CY62147GE (Address Transition Controlled) [26, 27]



### Notes

26. The device is continuously selected.  $\overline{OE} = V_{IL}$ ,  $\overline{CE} = V_{IL}$ ,  $\overline{BHE}$  or  $\overline{BLE}$  or both =  $V_{IL}$ .  
27.  $\overline{WE}$  is HIGH for Read cycle.

Switching Waveforms (continued)

Figure 12. Read Cycle No. 2 ( $\overline{OE}$  Controlled) [28, 29, 30]

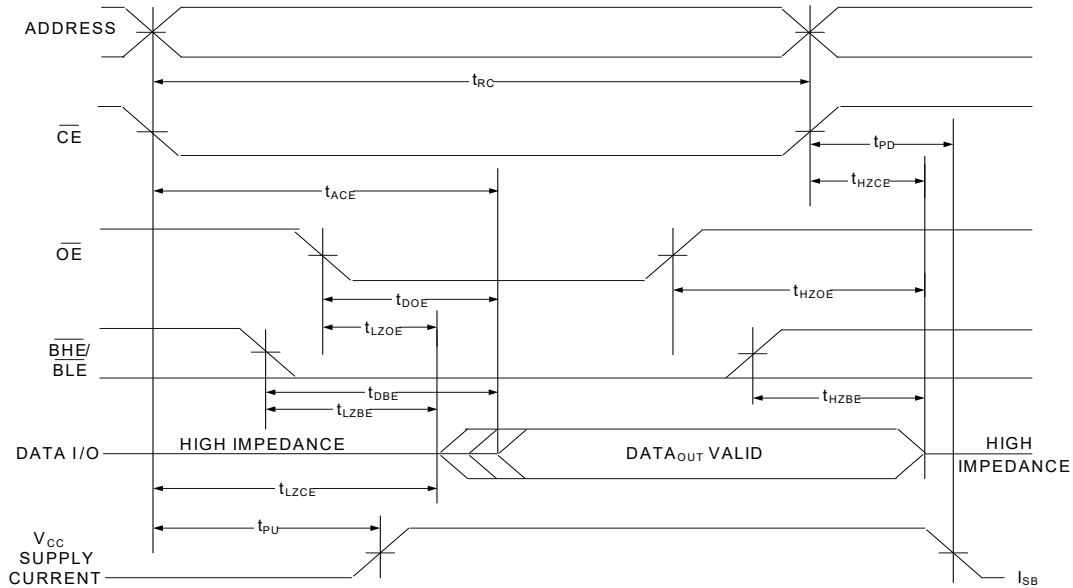
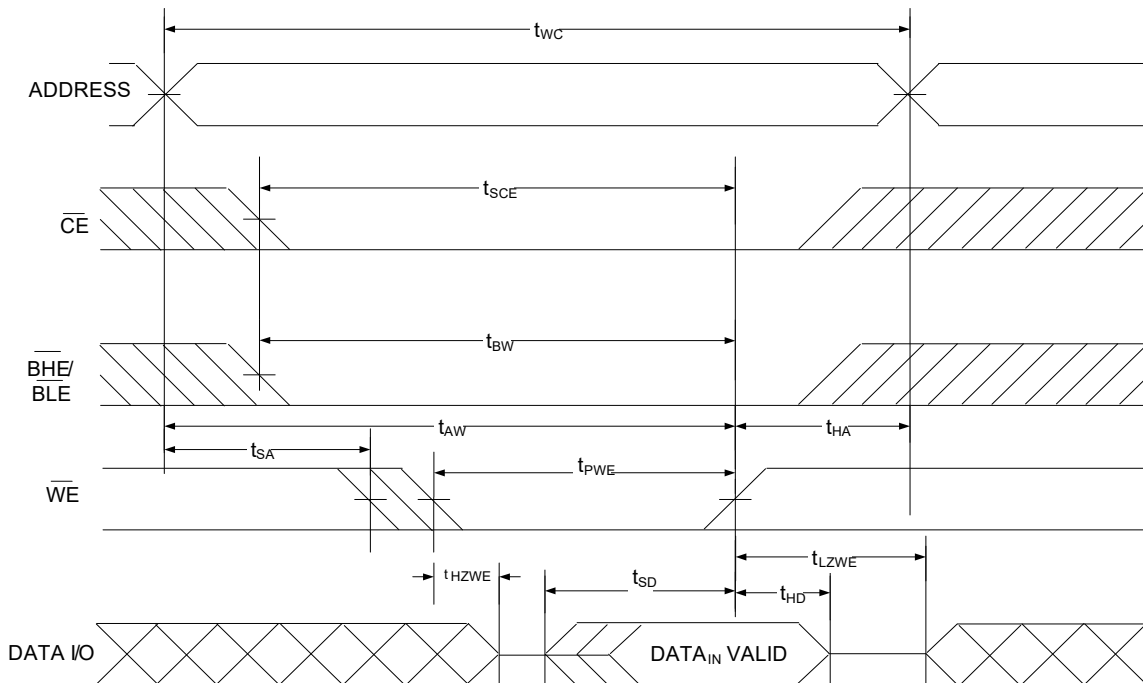

Figure 13. Write Cycle No. 1 ( $\overline{WE}$  Controlled) [29, 31, 32]



Notes

28.  $\overline{WE}$  is HIGH for Read cycle.
29. For all dual chip enable devices,  $\overline{CE}$  is the logical combination of  $\overline{CE}_1$  and  $CE_2$ . When  $\overline{CE}_1$  is LOW and  $CE_2$  is HIGH,  $\overline{CE}$  is LOW; when  $\overline{CE}_1$  is HIGH or  $CE_2$  is LOW,  $\overline{CE}$  is HIGH.
30. Address valid prior to or coincident with  $\overline{CE}$  LOW transition.
31. The internal write time of the memory is defined by the overlap of  $\overline{WE} = V_{IL}$ ,  $\overline{CE}_1 = V_{IL}$ ,  $\overline{BHE}$  or  $\overline{BLE}$  or both =  $V_{IL}$ , and  $CE_2 = V_{IH}$ . All signals must be ACTIVE to initiate a write and any of these signals can terminate a write by going INACTIVE. The data input setup and hold timing must refer to the edge of the signal that terminates the write.
32. Data I/O is in a HI-Z state if  $\overline{CE} = V_{IH}$ , or  $\overline{OE} = V_{IH}$  or  $\overline{BHE}$ , and/or  $\overline{BLE} = V_{IH}$ .

Switching Waveforms (continued)

Figure 14. Write Cycle No. 2 ( $\overline{CE}$  Controlled) [33, 34, 35]

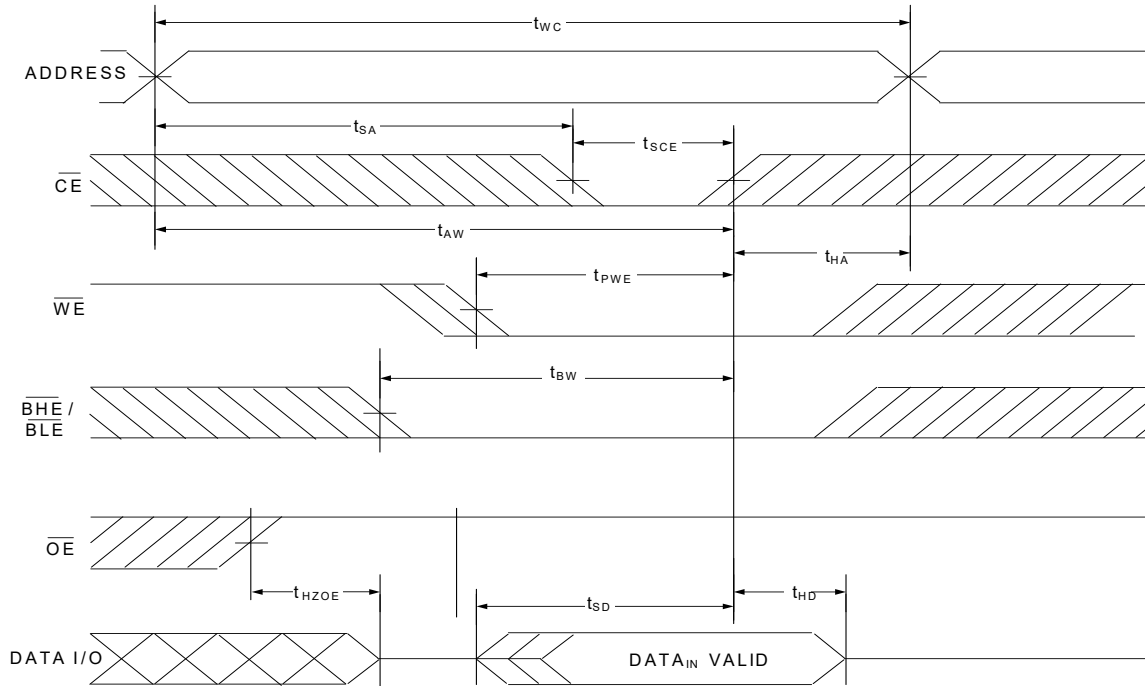
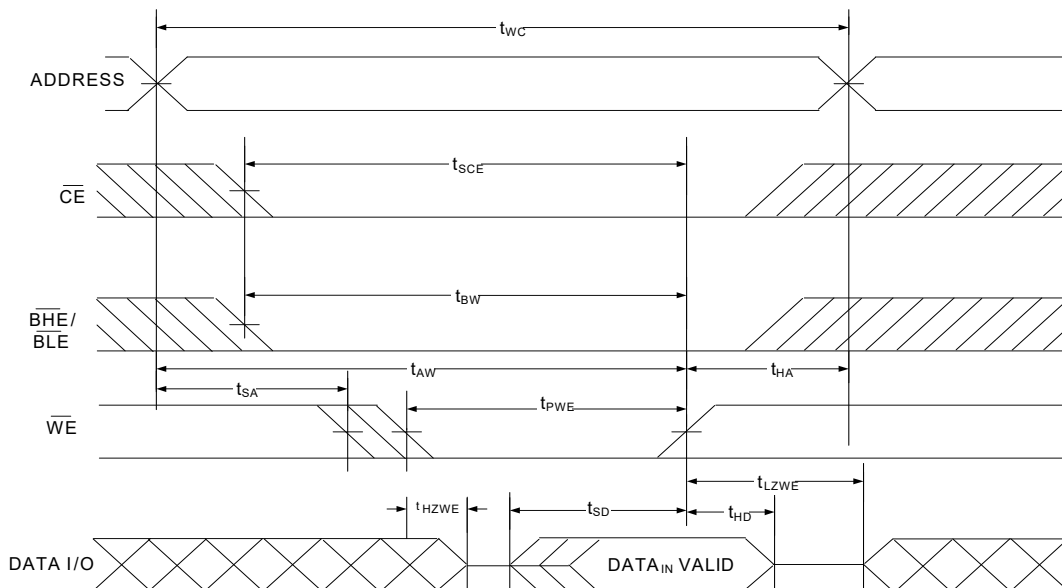

Figure 15. Write Cycle No. 3 ( $\overline{WE}$  Controlled,  $\overline{OE}$  LOW) [33, 34, 35, 36]



Notes

33. For all dual chip enable devices,  $\overline{CE}$  is the logical combination of  $\overline{CE}_1$  and  $CE_2$ . When  $\overline{CE}_1$  is LOW and  $CE_2$  is HIGH,  $\overline{CE}$  is LOW; when  $\overline{CE}_1$  is HIGH or  $CE_2$  is LOW,  $\overline{CE}$  is HIGH.
34. The internal write time of the memory is defined by the overlap of  $\overline{WE} = V_{IL}$ ,  $\overline{CE}_1 = V_{IL}$ ,  $\overline{BHE}$  or  $\overline{BLE}$  or both =  $V_{IL}$ , and  $CE_2 = V_{IH}$ . All signals must be ACTIVE to initiate a write and any of these signals can terminate a write by going INACTIVE. The data input setup and hold timing must refer to the edge of the signal that terminates the write.
35. Data I/O is in HI-Z state if  $\overline{CE} = V_{IH}$ , or  $\overline{OE} = V_{IH}$  or  $\overline{BHE}$ , and/or  $\overline{BLE} = V_{IH}$ .
36. The minimum write pulse width for Write Cycle No. 3 ( $\overline{WE}$  Controlled,  $\overline{OE}$  LOW) should be sum of  $t_{HZWE}$  and  $t_{SD}$ .

Switching Waveforms (continued)

Figure 16. Write Cycle No. 4 ( $\overline{\text{BHE}}/\overline{\text{BLE}}$  Controlled) [37, 38, 39]

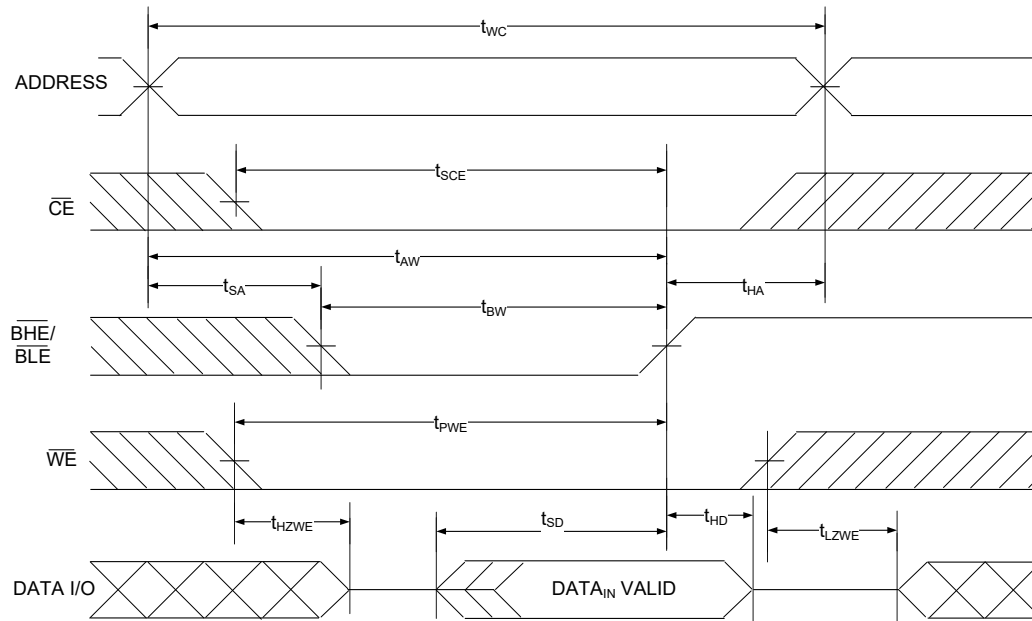

Notes

37. For all dual chip enable devices,  $\overline{\text{CE}}$  is the logical combination of  $\overline{\text{CE}}_1$  and  $\text{CE}_2$ . When  $\overline{\text{CE}}_1$  is LOW and  $\text{CE}_2$  is HIGH,  $\overline{\text{CE}}$  is LOW; when  $\overline{\text{CE}}_1$  is HIGH or  $\text{CE}_2$  is LOW,  $\overline{\text{CE}}$  is HIGH.
38. The internal write time of the memory is defined by the overlap of  $\overline{\text{WE}} = \text{V}_{\text{IL}}$ ,  $\overline{\text{CE}}_1 = \text{V}_{\text{IL}}$ ,  $\overline{\text{BHE}}$  or  $\overline{\text{BLE}}$  or both =  $\text{V}_{\text{IL}}$ , and  $\text{CE}_2 = \text{V}_{\text{IH}}$ . All signals must be ACTIVE to initiate a write and any of these signals can terminate a write by going INACTIVE. The data input setup and hold timing must refer to the edge of the signal that terminates the write.
39. Data I/O is in a HI-Z state if  $\overline{\text{CE}} = \text{V}_{\text{IH}}$ , or  $\overline{\text{OE}} = \text{V}_{\text{IH}}$  or  $\overline{\text{BHE}}$ , and/or  $\overline{\text{BLE}} = \text{V}_{\text{IH}}$ .

### Truth Table – CY62147G/CY62147GE

$\overline{CE}_1/\overline{CE}^{[40]}$	$CE_2^{[40]}$	$\overline{WE}$	$\overline{OE}$	$\overline{BHE}$	$\overline{BLE}$	Inputs/Outputs	Mode	Power
H	X <sup>[41]</sup>	X	X	X	X	HI-Z	Deselect/Power-down	Standby ( $I_{SB}$ )
X	L	X	X	X	X	HI-Z	Deselect/Power-down	Standby ( $I_{SB}$ )
X	X	X	X	H	H	HI-Z	Deselect/Power-down	Standby ( $I_{SB}$ )
L	H	H	L	L	L	Data Out ( $I/O_0$ – $I/O_{15}$ )	Read	Active ( $I_{CC}$ )
L	H	H	L	H	L	Data Out ( $I/O_0$ – $I/O_7$ ); HI-Z ( $I/O_8$ – $I/O_{15}$ )	Read	Active ( $I_{CC}$ )
L	H	H	L	L	H	HI-Z ( $I/O_0$ – $I/O_7$ ); Data Out ( $I/O_8$ – $I/O_{15}$ )	Read	Active ( $I_{CC}$ )
L	H	H	H	L	H	HI-Z	Output disabled	Active ( $I_{CC}$ )
L	H	H	H	H	L	HI-Z	Output disabled	Active ( $I_{CC}$ )
L	H	H	H	L	L	HI-Z	Output disabled	Active ( $I_{CC}$ )
L	H	L	X	L	L	Data In ( $I/O_0$ – $I/O_{15}$ )	Write	Active ( $I_{CC}$ )
L	H	L	X	H	L	Data In ( $I/O_0$ – $I/O_7$ ); HI-Z ( $I/O_8$ – $I/O_{15}$ )	Write	Active ( $I_{CC}$ )
L	H	L	X	L	H	HI-Z ( $I/O_0$ – $I/O_7$ ); Data In ( $I/O_8$ – $I/O_{15}$ )	Write	Active ( $I_{CC}$ )

### ERR Output – CY62147GE

Output <sup>[42]</sup>	Mode
0	Read operation, no single-bit error in the stored data.
1	Read operation, single-bit error detected and corrected.
HI-Z	Device deselected/outputs disabled/Write operation

#### Notes

40. For all dual chip enable devices,  $\overline{CE}$  is the logical combination of  $\overline{CE}_1$  and  $CE_2$ . When  $\overline{CE}_1$  is LOW and  $CE_2$  is HIGH,  $\overline{CE}$  is LOW; when  $\overline{CE}_1$  is HIGH or  $CE_2$  is LOW,  $\overline{CE}$  is HIGH

41. The 'X' (Don't care) state for the chip enables refer to the logic state (either HIGH or LOW). Intermediate voltage levels on these pins is not permitted.

42. ERR is an Output pin. If not used, this pin should be left floating



## Ordering Information

Speed (ns)	Voltage Range	Ordering Code	Package Diagram	Package Type	Operating Range
45	2.2 V–3.6 V	CY62147G30-45BVXI	51-85150	48-ball VFBGA (6 × 8 × 1 mm), Single Chip Enable without ERR	Industrial
		CY62147G30-45BVXIT	51-85150	48-ball VFBGA (6 × 8 × 1 mm), Single Chip Enable without ERR, Tape and Reel	
		CY62147GE30-45BVXI	51-85150	48-ball VFBGA (6 × 8 × 1 mm), Single Chip Enable with ERR	
		CY62147GE30-45BVXIT	51-85150	48-ball VFBGA (6 × 8 × 1 mm), Single Chip Enable with ERR, Tape and Reel	
		CY62147G30-45ZSXI	51-85087	44-pin TSOP II without ERR	
		CY62147G30-45ZSXIT	51-85087	44-pin TSOP II without ERR, Tape and Reel	
		CY62147GE30-45ZSXI	51-85087	44-pin TSOP II with ERR	
		CY62147GE30-45ZSXIT	51-85087	44-pin TSOP II with ERR, Tape and Reel	
		CY62147G30-45B2XI	51-85150	48-ball VFBGA (6 × 8 × 1 mm), Dual Chip Enable without ERR	
		CY62147G30-45B2XIT	51-85150	48-ball VFBGA (6 × 8 × 1 mm), Dual Chip Enable without ERR, Tape and Reel	
		CY621472G30-45ZSXI	51-85087	44-pin TSOP II without ERR, Dual Chip Enable	
		CY621472G30-45ZSXIT	51-85087	44-pin TSOP II without ERR, Dual Chip Enable, Tape and Reel	
	4.5 V–5.5 V	CY62147G-45ZSXI	51-85087	44-pin TSOP II without ERR	
		CY62147G-45ZSXIT	51-85087	44-pin TSOP II without ERR, Tape and Reel	
		CY62147GE-45ZSXI	51-85087	44-pin TSOP II with ERR	
		CY62147GE-45ZSXIT	51-85087	44-pin TSOP II with ERR, Tape and Reel	
		CY62147G-45BVXI	51-85150	48-ball VFBGA (6 × 8 × 1 mm), Single Chip Enable without ERR	
		CY62147G-45BVXIT	51-85150	48-ball VFBGA (6 × 8 × 1 mm), Single Chip Enable without ERR, Tape and Reel	
		CY62147GE-45BVXI	51-85150	48-ball VFBGA (6 × 8 × 1 mm), Single Chip Enable with ERR	
		CY62147GE-45BVXIT	51-85150	48-ball VFBGA (6 × 8 × 1 mm), Single Chip Enable with ERR, Tape and Reel	
55	1.8 V–2.2 V	CY62147G18-55ZSXI	51-85087	44-pin TSOP II without ERR	
		CY62147G18-55ZSXT	51-85087	44-pin TSOP II without ERR, Tape and Reel	
		CY62147G18-55BVXI	51-85150	48-ball VFBGA (6 × 8 × 1 mm), Single Chip Enable without ERR	
		CY62147G18-55BVXIT	51-85150	48-ball VFBGA (6 × 8 × 1 mm), Single Chip Enable without ERR, Tape and Reel	
		CY62147GE18-55ZSXI	51-85087	44-pin TSOP II with ERR	
		CY62147GE18-55ZSXIT	51-85087	44-pin TSOP II with ERR, Tape and Reel	
		CY62147GE18-55BVXI	51-85150	48-ball VFBGA (6 × 8 × 1 mm), Single Chip Enable with ERR	
		CY62147GE18-55BVXIT	51-85150	48-ball VFBGA (6 × 8 × 1 mm), Single Chip Enable with ERR, Tape and Reel	

**Ordering Code Definitions**

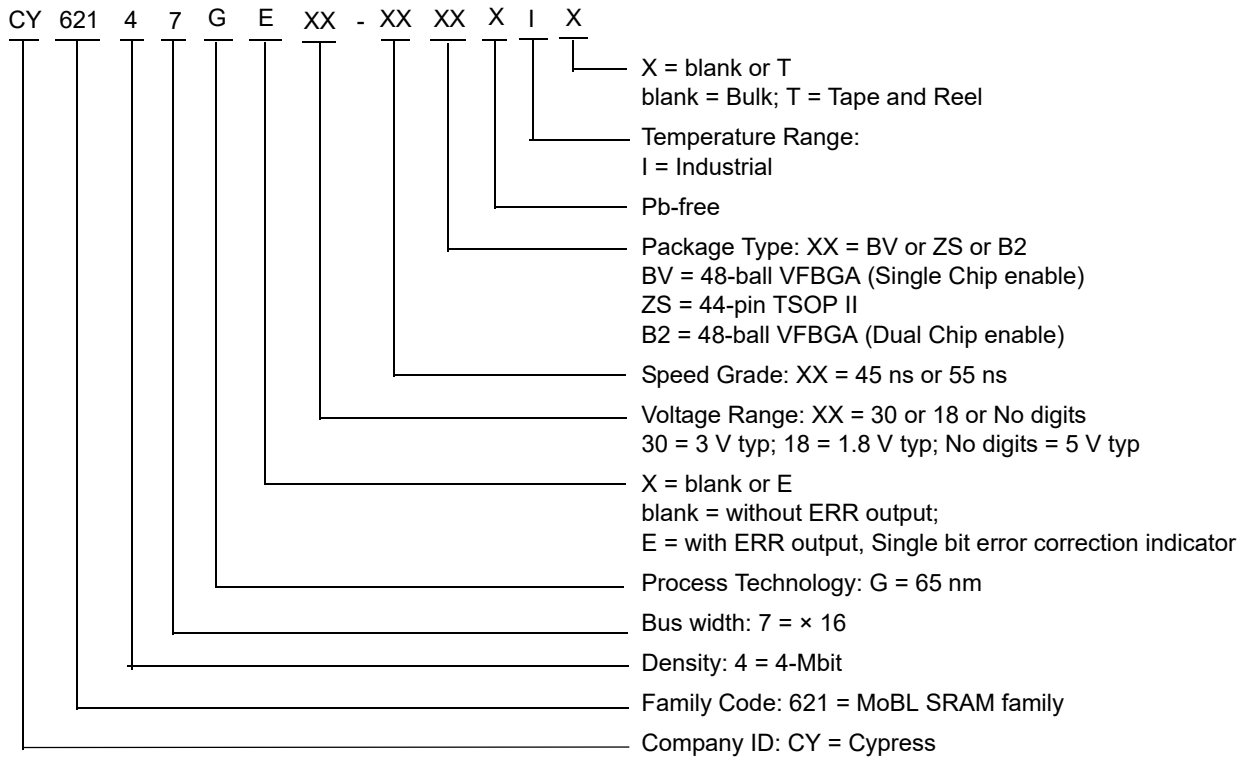

**Package Diagrams**

**Figure 17. 44-pin TSOP II (Z44) Package Outline, 51-85087**

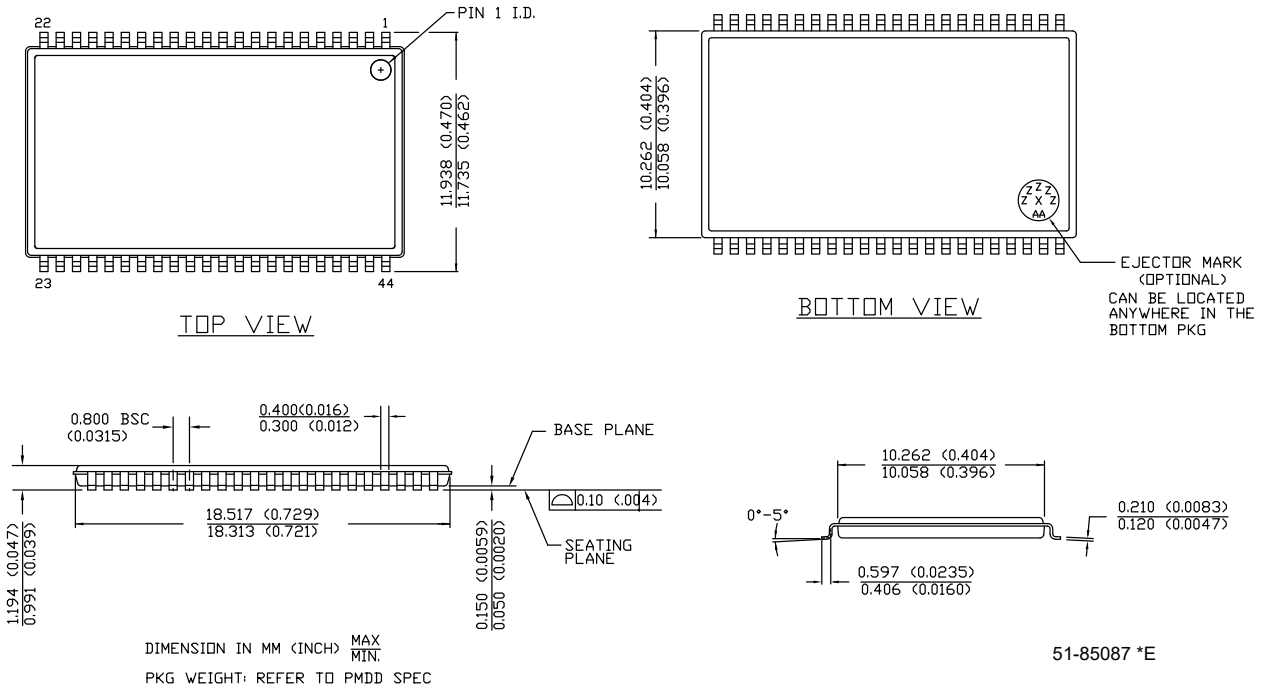

**Figure 18. 48-ball VFBGA (6 × 8 × 1.0 mm) BV48/BZ48 Package Outline, 51-85150**

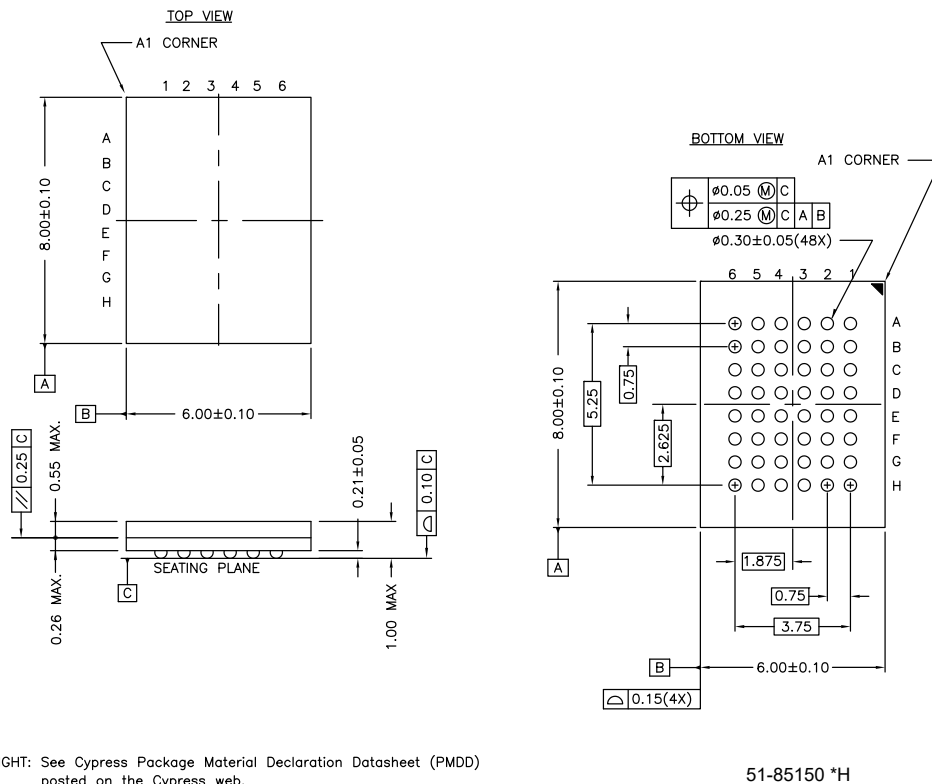

## Acronyms

Acronym	Description
$\overline{\text{BHE}}$	Byte High Enable
$\overline{\text{BLE}}$	Byte Low Enable
$\overline{\text{CE}}$	Chip Enable
CMOS	Complementary Metal Oxide Semiconductor
I/O	Input/Output
$\overline{\text{OE}}$	Output Enable
SRAM	Static Random Access Memory
TSOP	Thin Small Outline Package
VFBGA	Very Fine-Pitch Ball Grid Array
$\overline{\text{WE}}$	Write Enable

## Document Conventions

### Units of Measure

Symbol	Unit of Measure
°C	degree Celsius
MHz	megahertz
μA	microampere
μs	microsecond
mA	milliampere
mm	millimeter
ns	nanosecond
Ω	ohm
%	percent
pF	picofarad
V	volt
W	watt

## Document History Page

Document Title: CY62147G/CY621472G/CY62147GE MoBL®, 4-Mbit (256K words × 16-bit) Static RAM with Error-Correcting Code (ECC)				
Document Number: 001-92847				
Rev.	ECN No.	Orig. of Change	Submission Date	Description of Change
*F	4867081	NILE	07/31/2015	Changed status from Preliminary to Final.
*G	4968879	NILE	10/16/2015	Fixed typo in bookmarks.
*H	5019226	VINI	11/18/2015	Updated <a href="#">Ordering Information</a> : Updated part numbers.
*I	5432584	NILE	09/10/2016	Updated <a href="#">Maximum Ratings</a> : Updated Note 8 (Replaced “2 ns” with “20 ns”). Updated <a href="#">DC Electrical Characteristics</a> : Changed minimum value of $V_{IH}$ parameter from 2.0 V to 1.8 V corresponding to Operating Range “2.2 V to 2.7 V”. Updated <a href="#">Ordering Information</a> : Updated part numbers. Updated to new template.
*J	5787633	NILE	06/27/2017	Updated to new template. Completing Sunset Review.
*K	6245720	NILE	07/13/2018	Updated <a href="#">Features</a> : Added Note 2 and referred the same note in “Embedded ECC for single-bit error correction”. Updated to new template. Completing Sunset Review.

## Sales, Solutions, and Legal Information

### Worldwide Sales and Design Support

Cypress maintains a worldwide network of offices, solution centers, manufacturer's representatives, and distributors. To find the office closest to you, visit us at [Cypress Locations](#).

#### Products

Arm® Cortex® Microcontrollers	<a href="http://cypress.com/arm">cypress.com/arm</a>
Automotive	<a href="http://cypress.com/automotive">cypress.com/automotive</a>
Clocks & Buffers	<a href="http://cypress.com/clocks">cypress.com/clocks</a>
Interface	<a href="http://cypress.com/interface">cypress.com/interface</a>
Internet of Things	<a href="http://cypress.com/iot">cypress.com/iot</a>
Memory	<a href="http://cypress.com/memory">cypress.com/memory</a>
Microcontrollers	<a href="http://cypress.com/mcu">cypress.com/mcu</a>
PSoC	<a href="http://cypress.com/psoc">cypress.com/psoc</a>
Power Management ICs	<a href="http://cypress.com/pmic">cypress.com/pmic</a>
Touch Sensing	<a href="http://cypress.com/touch">cypress.com/touch</a>
USB Controllers	<a href="http://cypress.com/usb">cypress.com/usb</a>
Wireless Connectivity	<a href="http://cypress.com/wireless">cypress.com/wireless</a>

#### PSoC® Solutions

[PSoC 1](#) | [PSoC 3](#) | [PSoC 4](#) | [PSoC 5LP](#) | [PSoC 6 MCU](#)

#### Cypress Developer Community

[Community](#) | [Projects](#) | [Video](#) | [Blogs](#) | [Training](#) | [Components](#)

#### Technical Support

[cypress.com/support](http://cypress.com/support)

© Cypress Semiconductor Corporation, 2014–2018. This document is the property of Cypress Semiconductor Corporation and its subsidiaries, including Spansion LLC ("Cypress"). This document, including any software or firmware included or referenced in this document ("Software"), is owned by Cypress under the intellectual property laws and treaties of the United States and other countries worldwide. Cypress reserves all rights under such laws and treaties and does not, except as specifically stated in this paragraph, grant any license under its patents, copyrights, trademarks, or other intellectual property rights. If the Software is not accompanied by a license agreement and you do not otherwise have a written agreement with Cypress governing the use of the Software, then Cypress hereby grants you a personal, non-exclusive, nontransferable license (without the right to sublicense) (1) under its copyright rights in the Software (a) for Software provided in source code form, to modify and reproduce the Software solely for use with Cypress hardware products, only internally within your organization, and (b) to distribute the Software in binary code form externally to end users (either directly or indirectly through resellers and distributors), solely for use on Cypress hardware product units, and (2) under those claims of Cypress's patents that are infringed by the Software (as provided by Cypress, unmodified) to make, use, distribute, and import the Software solely for use with Cypress hardware products. Any other use, reproduction, modification, translation, or compilation of the Software is prohibited.

TO THE EXTENT PERMITTED BY APPLICABLE LAW, CYPRESS MAKES NO WARRANTY OF ANY KIND, EXPRESS OR IMPLIED, WITH REGARD TO THIS DOCUMENT OR ANY SOFTWARE OR ACCOMPANYING HARDWARE, INCLUDING, BUT NOT LIMITED TO, THE IMPLIED WARRANTIES OF MERCHANTABILITY AND FITNESS FOR A PARTICULAR PURPOSE. No computing device can be absolutely secure. Therefore, despite security measures implemented in Cypress hardware or software products, Cypress does not assume any liability arising out of any security breach, such as unauthorized access to or use of a Cypress product. In addition, the products described in these materials may contain design defects or errors known as errata which may cause the product to deviate from published specifications. To the extent permitted by applicable law, Cypress reserves the right to make changes to this document without further notice. Cypress does not assume any liability arising out of the application or use of any product or circuit described in this document. Any information provided in this document, including any sample design information or programming code, is provided only for reference purposes. It is the responsibility of the user of this document to properly design, program, and test the functionality and safety of any application made of this information and any resulting product. Cypress products are not designed, intended, or authorized for use as critical components in systems designed or intended for the operation of weapons, weapons systems, nuclear installations, life-support devices or systems, other medical devices or systems (including resuscitation equipment and surgical implants), pollution control or hazardous substances management, or other uses where the failure of the device or system could cause personal injury, death, or property damage ("Unintended Uses"). A critical component is any component of a device or system whose failure to perform can be reasonably expected to cause the failure of the device or system, or to affect its safety or effectiveness. Cypress is not liable, in whole or in part, and you shall and hereby do release Cypress from any claim, damage, or other liability arising from or related to all Unintended Uses of Cypress products. You shall indemnify and hold Cypress harmless from and against all claims, costs, damages, and other liabilities, including claims for personal injury or death, arising from or related to any Unintended Uses of Cypress products.

Cypress, the Cypress logo, Spansion, the Spansion logo, and combinations thereof, WICED, PSoC, CapSense, EZ-USB, F-RAM, and Traveo are trademarks or registered trademarks of Cypress in the United States and other countries. For a more complete list of Cypress trademarks, visit [cypress.com](http://cypress.com). Other names and brands may be claimed as property of their respective owners.

## X-ON Electronics

Largest Supplier of Electrical and Electronic Components

*Click to view similar products for [SRAM](#) category:*

*Click to view products by [Cypress](#) manufacturer:*

Other Similar products are found below :

[CY6116A-35DMB](#) [CY7C1049GN-10VXI](#) [CY7C128A-45DMB](#) [GS8161Z36DD-200I](#) [GS88237CB-200I](#) [RMLV0408EGSB-4S2#AA0](#)  
[IDT70V5388S166BG](#) [IS64WV3216BLL-15CTLA3](#) [IS66WVE4M16ECLL-70BLI](#) [PCF8570P](#) [K6F2008V2E-LF70000](#) [K6T4008C1B-GB70](#)  
[CY7C1353S-100AXC](#) [AS6C8016-55BIN](#) [AS7C164A-15PCN](#) [515712X](#) [IDT71V67603S133BG](#) [IS62WV51216EBLL-45BLI](#)  
[IS63WV1288DBLL-10HLI](#) [IS66WVE2M16ECLL-70BLI](#) [70V639S10BCG](#) [IS66WVE4M16EALL-70BLI](#) [IS62WV6416DBLL-45BLI](#)  
[IS61WV102416DBLL-10TLI](#) [CY7C1381KV33-100AXC](#) [CY7C1381KVE33-133AXI](#) [8602501XA](#) [5962-3829425MUA](#) [5962-3829430MUA](#)  
[5962-8855206YA](#) [5962-8866201YA](#) [5962-8866204TA](#) [5962-8866206MA](#) [5962-8866208UA](#) [5962-8872502XA](#) [5962-9062007MXA](#) [5962-](#)  
[9161705MXA](#) [70V3579S6BFI](#) [GS882Z18CD-150I](#) [M38510/28902BVA](#) [8413202RA](#) [5962-9161708MYA](#) [5962-8971203XA](#) [5962-](#)  
[8971202ZA](#) [5962-8872501LA](#) [5962-8866208YA](#) [5962-8866205YA](#) [5962-8866205UA](#) [5962-8866203YA](#) [5962-8855202YA](#)