



The following document contains information on Cypress products. The document has the series name, product name, and ordering part numbering with the prefix “MB”. However, Cypress will offer these products to new and existing customers with the series name, product name, and ordering part number with the prefix “CY”.

How to Check the Ordering Part Number

1. Go to www.cypress.com/pcn.
2. Enter the keyword (for example, ordering part number) in the **SEARCH PCNS** field and click **Apply**.
3. Click the corresponding title from the search results.
4. Download the Affected Parts List file, which has details of all changes

For More Information

Please contact your local sales office for additional information about Cypress products and solutions.

About Cypress

Cypress is the leader in advanced embedded system solutions for the world's most innovative automotive, industrial, smart home appliances, consumer electronics and medical products. Cypress' microcontrollers, analog ICs, wireless and USB-based connectivity solutions and reliable, high-performance memories help engineers design differentiated products and get them to market first. Cypress is committed to providing customers with the best support and development resources on the planet enabling them to disrupt markets by creating new product categories in record time. To learn more, go to www.cypress.com.

MB95410H/470H is a series of general-purpose, single-chip microcontrollers. In addition to a compact instruction set, the microcontrollers of this series contain a variety of peripheral resources.

Features

F²MC-8FX CPU core

Instruction set optimized for controllers

- Multiplication and division instructions
- 16-bit arithmetic operations
- Bit test branch instructions
- Bit manipulation instructions, etc.

Clock

- Selectable main clock source
 - Main OSC clock (up to 16.25 MHz, maximum machine clock frequency: 8.125 MHz)
 - External clock (up to 32.5 MHz, maximum machine clock frequency: 16.25 MHz)
 - Main CR clock (1/8/10/12.5 MHz ±2%, maximum machine clock frequency: 12.5 MHz)
 - Main PLL clock (up to 16.25 MHz, maximum machine clock frequency: 16.25 MHz)
- Selectable subclock source
 - Sub-OSC clock (32.768 kHz)
 - External clock (32.768 kHz)
 - Sub-CR clock (Typ: 100 kHz, Min: 50 kHz, Max: 200 kHz)

Timer

- 8/16-bit composite timer × 2 channels
- 8/16-bit PPG × 2 channels
- 16-bit reload timer × 1 channel
- Event counter × 1 channel
- Time-base timer × 1 channel
- Watch prescaler × 1 channel

UART-SIO

- Capable of clock-asynchronous (UART) serial data transfer and clock-synchronous (SIO) serial data transfer
- Full duplex double buffer

I²C

Built-in wake-up function

External interrupt

- Interrupt by edge detection (rising edge, falling edge, and both edges can be selected)
- Can be used to wake up the device from different low power consumption (standby) modes

8/10-bit A/D converter

- 8-bit or 10-bit resolution can be selected

LCD controller (LCDC)

- On MB95F414H/F414K/F416H/F416K/F418H/F418K, LCD output can be selected from 40 SEG × 4 COM to 36 SEG × 8 COM.
- On MB95F474H/F474K/F476H/F476K/F478H/F478K, LCD output can be selected from 32 SEG × 4 COM to 28 SEG × 8 COM.
- Internal divider resistor whose resistance value can be selected from 10 kΩ or 100 kΩ through software
- Interrupt in sync with the LCD module frame frequency
- Blinking function
- Inverted display function

Low power consumption (standby) modes

- Stop mode
- Sleep mode
- Watch mode
- Time-base timer mode

I/O port

- MB95F414H/F416H/F418H (maximum no. of I/O ports: 74)
 - General-purpose I/O ports (N-ch open drain) : 3
 - General-purpose I/O ports (CMOS I/O) : 71
- MB95F414K/F416K/F418K (maximum no. of I/O ports: 75)
 - General-purpose I/O ports (N-ch open drain) : 4
 - General-purpose I/O ports (CMOS I/O) : 71
- MB95F474H/F476H/F478H (maximum no. of I/O ports: 58)
 - General-purpose I/O ports (N-ch open drain) : 3
 - General-purpose I/O ports (CMOS I/O) : 55
- MB95F474K/F476K/F478K (maximum no. of I/O ports: 59)
 - General-purpose I/O ports (N-ch open drain) : 4
 - General-purpose I/O ports (CMOS I/O) : 55

On-chip debug

- 1-wire serial control
- Serial writing supported (asynchronous mode)

Hardware/software watchdog timer

- Built-in hardware watchdog timer
- Built-in software watchdog timer

Low-voltage detection reset circuit

Built-in low-voltage detector

Clock supervisor counter

Built-in clock supervisor counter function

Programmable port input voltage level

CMOS input level / hysteresis input level

Dual operation Flash memory

The program/erase operation and the read operation can be executed in different banks (upper bank/lower bank) simultaneously.

Flash memory security function

Protects the content of the Flash memory

Contents

Product Line-up	4	I/O Map (MB95470H Series)	39
Oscillation Stabilization Wait Time	8	Interrupt Source Table	45
Packages And Corresponding Products	8	Electrical Characteristics	46
Differences among Products and Notes		Absolute Maximum Ratings	46
on Product Selection	9	Recommended Operating Conditions	48
Pin Assignment	10	DC Characteristics	49
Pin Description (MB95410H Series)	12	AC Characteristics	53
Pin Description (MB95470H Series)	18	A/D Converter	67
I/O Circuit Type	23	Flash Memory Program/Erase Characteristics	71
Notes on Device Handling	28	Sample Characteristics	72
Pin Connection	28	Mask Options	78
Block Diagram (MB95410H Series)	30	Ordering Information	79
Block Diagram (MB95470H Series)	31	Package Dimension	80
CPU Core	32	Major Changes	83
I/O Map (MB95410H Series)	33	Document History	84

1. Product Line-up
MB95410H Series

Part number	MB95F414H	MB95F416H	MB95F418H	MB95F414K	MB95F416K	MB95F418K
Package						
Type	Flash memory product					
Clock supervisor counter	It supervises the main clock oscillation.					
Program ROM capacity	20 Kbyte	36 Kbyte	60 Kbyte	20 Kbyte	36 Kbyte	60 Kbyte
RAM capacity	496 bytes	1008 bytes	2032 bytes	496 bytes	1008 bytes	2032 bytes
Low-voltage detection reset	No			Yes		
Reset input	Dedicated			Selected through software		
CPU functions	<ul style="list-style-type: none"> • Number of basic instructions : 136 • Instruction bit length : 8 bits • Instruction length : 1 to 3 bytes • Data bit length : 1, 8 and 16 bits • Minimum instruction execution time : 61.5 ns (machine clock frequency = 16.25 MHz) • Interrupt processing time : 0.6 μs (machine clock frequency = 16.25 MHz) 					
General-purpose I/O	<ul style="list-style-type: none"> • I/O ports (Max) : 74 • CMOS I/O : 71 • N-ch open drain : 3 			<ul style="list-style-type: none"> • I/O ports (Max) : 75 • CMOS I/O : 71 • N-ch open drain : 4 		
Time-base timer	Interval time: 0.256 ms - 8.3 s (external clock frequency = 4 MHz)					
Hardware/software watchdog timer	<ul style="list-style-type: none"> • Reset generation cycle Main oscillation clock at 10 MHz: 105 ms (Min) • The sub-CR clock can be used as the source clock of the hardware watchdog timer. 					
Wild register	It can be used to replace three bytes of data.					
I ² C	1 channel					
	<ul style="list-style-type: none"> • Master/Slave sending and receiving • Bus error function and arbitration function • Detecting transmitting direction function • Start condition repeated generation and detection functions • Built-in wake-up function 					
UART/SIO	3 channels					
	<ul style="list-style-type: none"> • Data transfer with UART/SIO is enabled. • It has a full duplex double buffer, variable data length (5/6/7/8 bits), a built-in baud rate generator and an error detection function. • It uses the NRZ type transfer format. • LSB-first data transfer and MSB-first data transfer are available to use. • Clock-asynchronous (UART) serial data transfer and clock-synchronous (SIO) serial data transfer is enabled. 					
8/10-bit A/D converter	8 channels					
	8-bit or 10-bit resolution can be selected.					

(Continued)

(Continued)

Part number	MB95F414H	MB95F416H	MB95F418H	MB95F414K	MB95F416K	MB95F418K
Package						
8/16-bit composite timer	2 channels <ul style="list-style-type: none"> Each timer can be configured as an "8-bit timer × 2 channels" or a "16-bit timer × 1 channel". It has built-in timer function, PWC function, PWM function and input capture function. Count clock: it can be selected from internal clocks (seven types) and external clocks. It can output square wave. 					
LCD controller (LCDC)	<ul style="list-style-type: none"> COM output: 4 or 8 (selectable) SEG output: 36 or 40 (selectable) <ul style="list-style-type: none"> If the number of COM outputs is 4, the maximum number of SEG outputs is 40, and the maximum number of pixels that can be displayed 160 (4×40). If the number of COM outputs is 8, the maximum number of SEG outputs is 36, and the maximum number of pixels that can be displayed 288 (8×36). LCD drive power supply (bias) pins: 5 (Max) Duty LCD mode LCD standby mode Blinking function Internal divider resistor whose resistance value can be selected from 10 kΩ or 100 kΩ through software Interrupt in sync with the LCD module frame frequency Inverted display function 					
16-bit reload timer	1 channel <ul style="list-style-type: none"> Two clock modes and two counter operating modes can be selected Square waveform output Count clock: it can be selected from internal clocks (seven types) and external clocks. Counter operating mode: reload mode or one-shot mode can be selected 					
Event counter	By configuring the 16-bit reload timer and the 8/16-bit composite timer ch. 1, event counter function can be implemented. When the event counter function is used, the 16-bit reload timer and the 8/16-bit composite timer ch. 1 are unavailable.					
8/16-bit PPG	2 channels <ul style="list-style-type: none"> Each channel of the PPG can be used as "8-bit PPG × 2 channels" or "16-bit PPG × 1 channel" Counter operating clock: Eight selectable clock sources 					
Watch counter	<ul style="list-style-type: none"> Count clock: Four selectable clock sources (125 ms, 250 ms, 500 ms or 1 s) Counter value can be set from 0 to 63. (Capable of counting for 1 minute when the clock source is 1 second and the counter value is to 60) 					
External interrupt	8 channels <ul style="list-style-type: none"> Interrupt by edge detection (The rising edge, falling edge, or both edges can be selected.) It can be used to wake up the device from the standby mode. 					
On-chip debug	<ul style="list-style-type: none"> 1-wire serial control It supports serial writing. (asynchronous mode) 					
Watch prescaler	Eight different time intervals can be selected. (62.5 ms, 125 ms, 250 ms, 500 ms, 1 s, 2 s, 4 s, 8 s)					
Flash memory	<ul style="list-style-type: none"> It supports automatic programming, Embedded Algorithm, program/erase/erase-suspend/erase-resume commands. It has a flag indicating the completion of the operation of Embedded Algorithm. Number of program/erase cycles: 100000 Data retention time: 20 years Flash security feature for protecting the content of the Flash memory 					
Standby mode	Sleep mode, stop mode, watch mode, time-base timer mode					
Package	FPT-80P-M37					

MB95470H Series

Part number	MB95F474H	MB95F476H	MB95F478H	MB95F474K	MB95F476K	MB95F478K
Package						
Type	Flash memory product					
Clock supervisor counter	It supervises the main clock oscillation.					
Program ROM capacity	20 Kbyte	36 Kbyte	60 Kbyte	20 Kbyte	36 Kbyte	60 Kbyte
RAM capacity	496 bytes	1008 bytes	2032 bytes	496 bytes	1008 bytes	2032 bytes
Low-voltage detection reset	No			Yes		
Reset input	Dedicated			Selected through software		
CPU functions	<ul style="list-style-type: none"> • Number of basic instructions : 136 • Instruction bit length : 8 bits • Instruction length : 1 to 3 bytes • Data bit length : 1, 8 and 16 bits • Minimum instruction execution time : 61.5 ns (machine clock frequency = 16.25 MHz) • Interrupt processing time : 0.6 μs (machine clock frequency = 16.25 MHz) 					
General-purpose I/O	<ul style="list-style-type: none"> • I/O ports (Max) : 58 • CMOS I/O : 55 • N-ch open drain : 3 			<ul style="list-style-type: none"> • I/O ports (Max) : 59 • CMOS I/O : 55 • N-ch open drain : 4 		
Time-base timer	Interval time: 0.256 ms - 8.3 s (external clock frequency = 4 MHz)					
Hardware/software watchdog timer	<ul style="list-style-type: none"> • Reset generation cycle • Main oscillation clock at 10 MHz: 105 ms (Min) • The sub-CR clock can be used as the source clock of the hardware watchdog timer. 					
Wild register	It can be used to replace three bytes of data.					
I ² C	1 channel					
	<ul style="list-style-type: none"> • Master/Slave sending and receiving • Bus error function and arbitration function • Detecting transmitting direction function • Start condition repeated generation and detection functions • Built-in wake-up function 					
UART/SIO	3 channels					
	<ul style="list-style-type: none"> • Data transfer with UART/SIO is enabled. • It has a full duplex double buffer, variable data length (5/6/7/8 bits), a built-in baud rate generator and an error detection function. • It uses the NRZ type transfer format. • LSB-first data transfer and MSB-first data transfer are available to use. • Clock-asynchronous (UART) serial data transfer and clock-synchronous (SIO) serial data transfer is enabled. 					
8/10-bit A/D converter	8 channels					
	8-bit or 10-bit resolution can be selected.					
8/16-bit composite timer	2 channels					
	<ul style="list-style-type: none"> • Each timer can be configured as an "8-bit timer \times 2 channels" or a "16-bit timer \times 1 channel". • It has built-in timer function, PWC function, PWM function and input capture function. • Count clock: it can be selected from internal clocks (seven types) and external clocks. • It can output square wave. 					

(Continued)

(Continued)

Part number	MB95F474H	MB95F476H	MB95F478H	MB95F474K	MB95F476K	MB95F478K
Package						
LCD controller (LCDC)	<ul style="list-style-type: none"> • COM output: 4 or 8 (selectable) • SEG output: 28 or 32 (selectable) <ul style="list-style-type: none"> - If the number of COM outputs is 4, the maximum number of SEG outputs is 32, and the maximum number of pixels that can be displayed 128 (4×32). - If the number of COM outputs is 8, the maximum number of SEG outputs is 28, and the maximum number of pixels that can be displayed 224 (8×28). • LCD drive power supply (bias) pins: 4 (Max) 					
	<ul style="list-style-type: none"> • Duty LCD mode • LCD standby mode • Blinking function • Internal divider resistor whose resistance value can be selected from 10 kΩ or 100 kΩ through software • Inverted display function 					
16-bit reload timer	1 channel <ul style="list-style-type: none"> • Two clock modes and two counter operating modes can be selected • Square waveform output • Count clock: it can be selected from internal clocks (seven types) and external clocks. • Counter operating mode: reload mode or one-shot mode can be selected 					
Event counter	By configuring the 16-bit reload timer and the 8/16-bit composite timer ch. 1, event counter function can be implemented. When the event counter function is used, the 16-bit reload timer and the 8/16-bit composite timer ch. 1 are unavailable.					
8/16-bit PPG	2 channels <ul style="list-style-type: none"> • Each channel of the PPG can be used as “8-bit PPG × 2 channels” or “16-bit PPG × 1 channel” • Counter operating clock: Eight selectable clock sources 					
Watch counter	<ul style="list-style-type: none"> • Count clock: Four selectable clock sources (125 ms, 250 ms, 500 ms or 1 s) • Counter value can be set from 0 to 63. (Capable of counting for 1 minute when the clock source is 1 second and the counter value is to 60) 					
External interrupt	8 channels <p>Interrupt by edge detection (The rising edge, falling edge, or both edges can be selected.)</p> <p>It can be used to wake up the device from the standby mode.</p>					
On-chip debug	<ul style="list-style-type: none"> • 1-wire serial control • It supports serial writing. (asynchronous mode) 					
Watch prescaler	Eight different time intervals can be selected. (62.5 ms, 125 ms, 250 ms, 500 ms, 1 s, 2 s, 4 s, 8 s)					
Flash memory	<ul style="list-style-type: none"> • It supports automatic programming, Embedded Algorithm, program/erase/erase-suspend/erase-resume commands. • It has a flag indicating the completion of the operation of Embedded Algorithm. • Number of program/erase cycles: 100000 • Data retention time: 20 years • Flash security feature for protecting the content of the Flash memory 					
Standby mode	Sleep mode, stop mode, watch mode, time-base timer mode					
Package	FPT-64P-M38 FPT-64P-M39					

2. Oscillation Stabilization Wait Time

The main CR clock oscillation stabilization wait time is fixed to the maximum value. Below is the maximum value.

Oscillation stabilization wait time	Remarks
$(2^{10} - 2) / F_{CRH}$	Approx. 128 μ s (when the main CR clock is 8 MHz)

The main PLL clock oscillation stabilization wait time is fixed to the maximum value. Below is the maximum value.

Oscillation stabilization wait time	Remarks
$(2^{14} - 2) / F_{CH}$	Approx. 14.1 ms (when the main PLL clock is 4 MHz)

3. Packages And Corresponding Products

Part number	MB95F414H	MB95F416H	MB95F418H	MB95F414K	MB95F416K	MB95F418K
Package						
FPT-80P-M37				○		

Part number	MB95F474H	MB95F476H	MB95F478H	MB95F474K	MB95F476K	MB95F478K
Package						
FPT-64P-M38				○		
FPT-64P-M39				○		

○: Available

4. Differences among Products and Notes on Product Selection

Current consumption

When using the on-chip debug function, take account of the current consumption of flash erase/write.

For details of current consumption, see “17. Electrical Characteristics”.

Package

For details of information on each package, see “3. Packages And Corresponding Products” and “21. Package Dimension”.

Operating voltage

The operating voltage varies, depending on whether the on-chip debug function is used or not.

For details of the operating voltage, see “17. Electrical Characteristics”.

On-chip debug function

The on-chip debug function requires that V_{CC} , V_{SS} and 1 serial-wire be connected to an evaluation tool. For details of the connection method, refer to “Chapter 31 Example Of Serial Programming Connection” in the hardware manual of the MB95410H/470H Series.

5. Pin Assignment

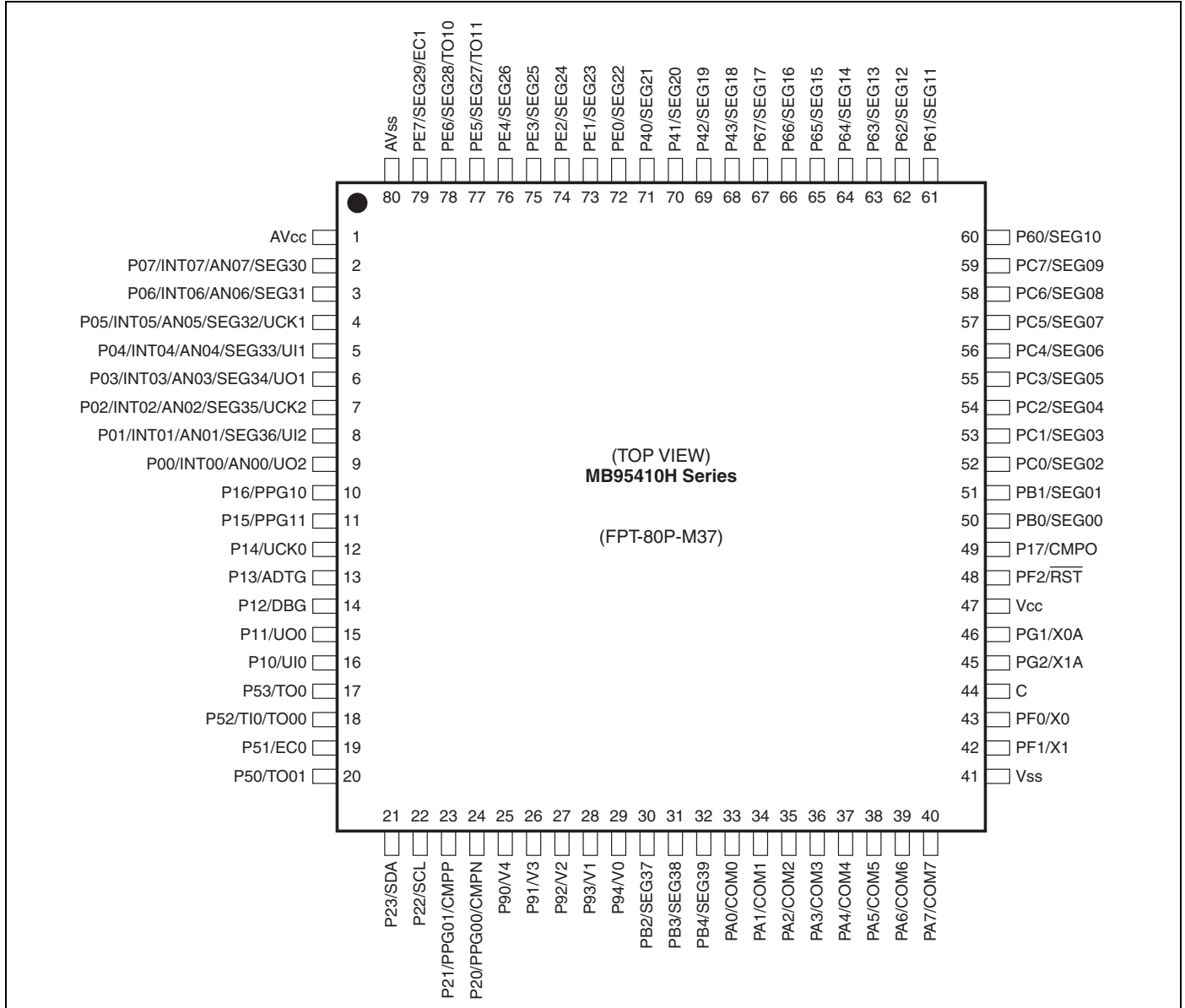

(Continued)

(Continued)

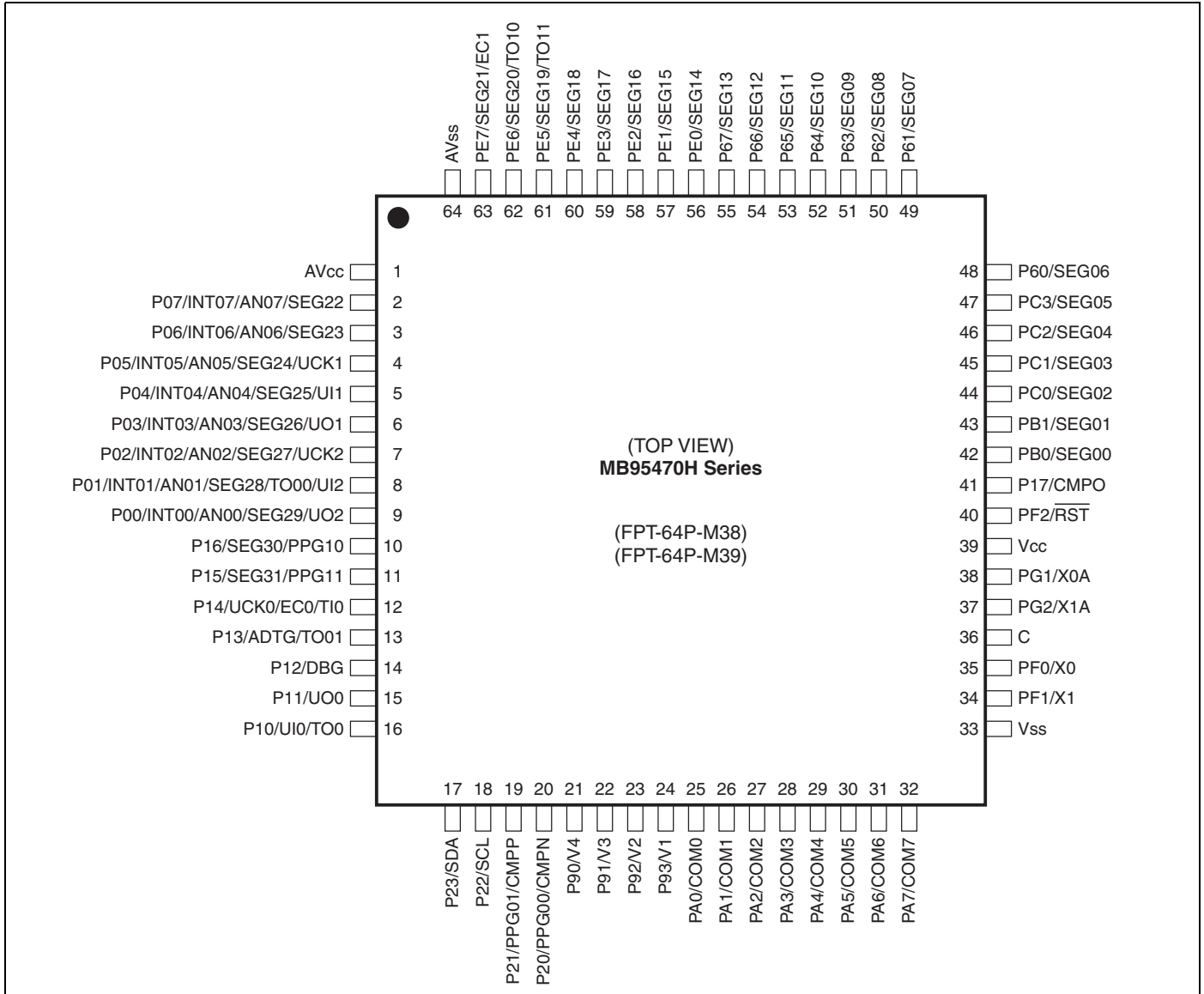

6. Pin Description (MB95410H Series)

Pin no.	Pin name	I/O circuit type*	Function
1	AV _{CC}	—	A/D converter power supply pin
2	P07	S	General-purpose I/O port
	INT07		External interrupt input pin
	AN07		A/D analog input pin
	SEG30		LCDC SEG output pin
3	P06	S	General-purpose I/O port
	INT06		External interrupt input pin
	AN06		A/D analog input pin
	SEG31		LCDC SEG output pin
4	P05	S	General-purpose I/O port
	INT05		External interrupt input pin
	AN05		A/D analog input pin
	SEG32		LCDC SEG output pin
	UCK1		UART/SIO ch. 1 clock I/O pin
5	P04	V	General-purpose I/O port
	INT04		External interrupt input pin
	AN04		A/D analog input pin
	SEG33		LCDC SEG output pin
	UI1		UART/SIO ch. 1 data input pin
6	P03	S	General-purpose I/O port
	INT03		External interrupt input pin
	AN03		A/D analog input pin
	SEG34		LCDC SEG output pin
	UO1		UART/SIO ch. 1 data output pin
7	P02	S	General-purpose I/O port
	INT02		External interrupt input pin
	AN02		A/D analog input pin
	SEG35		LCDC SEG output pin
	UCK2		UART/SIO ch. 2 clock I/O pin
8	P01	V	General-purpose I/O port
	INT01		External interrupt input pin
	AN01		A/D analog input pin
	SEG36		LCDC SEG output pin
	UI2		UART/SIO ch. 2 data input pin

(Continued)

Pin no.	Pin name	I/O circuit type*	Function
9	P00	W	General-purpose I/O port
	INT00		External interrupt input pin
	AN00		A/D analog input pin
	UO2		UART/SIO ch. 2 data output pin
10	P16	Y	General-purpose I/O port
	PPG10		8/16-bit PPG ch. 1 output pin
11	P15	Y	General-purpose I/O port
	PPG11		8/16-bit PPG ch. 1 output pin
12	P14	H	General-purpose I/O port
	UCK0		UART/SIO ch. 0 clock I/O pin
13	P13	H	General-purpose I/O port
	ADTG		A/D trigger input (ADTG) pin
14	P12	D	General-purpose I/O port
	DBG		DBG input pin
15	P11	H	General-purpose I/O port
	UO0		UART/SIO ch. 0 data output pin
16	P10	G	General-purpose I/O port
	UI0		UART/SIO ch. 0 data input pin
17	P53	H	General-purpose I/O port
	TO0		16-bit reload timer output pin
18	P52	H	General-purpose I/O port
	TI0		16-bit reload timer input pin
	TO00		8/16-bit composite timer ch. 0 output pin
19	P51	H	General-purpose I/O port
	EC0		8/16-bit composite timer ch. 0 clock input pin
20	P50	H	General-purpose I/O port
	TO01		8/16-bit composite timer ch. 0 output pin
21	P23	I	General-purpose I/O port
	SDA		I ² C data I/O pin
22	P22	I	General-purpose I/O port
	SCL		I ² C clock I/O pin
23	P21	T	General-purpose I/O port
	PPG01		8/16-bit PPG ch. 0 output pin
	CMPP		Voltage comparator input pin
24	P20	T	General-purpose I/O port
	PPG00		8/16-bit PPG ch. 0 output pin
	CMPN		Voltage comparator input pin

(Continued)

Pin no.	Pin name	I/O circuit type*	Function
25	P90	R	General-purpose I/O port
	V4		LCDC drive power supply pin
26	P91	R	General-purpose I/O port
	V3		LCDC drive power supply pin
27	P92	R	General-purpose I/O port
	V2		LCDC drive power supply pin
28	P93	R	General-purpose I/O port
	V1		LCDC drive power supply pin
29	P94	R	General-purpose I/O port
	V0		LCDC drive power supply pin
30	PB2	M	General-purpose I/O port
	SEG37		LCDC SEG output pin
31	PB3	M	General-purpose I/O port
	SEG38		LCDC SEG output pin
32	PB4	M	General-purpose I/O port
	SEG39		LCDC SEG output pin
33	PA0	M	General-purpose I/O port
	COM0		LCDC COM output pin
34	PA1	M	General-purpose I/O port
	COM1		LCDC COM output pin
35	PA2	M	General-purpose I/O port
	COM2		LCDC COM output pin
36	PA3	M	General-purpose I/O port
	COM3		LCDC COM output pin
37	PA4	M	General-purpose I/O port
	COM4		LCDC COM output pin
38	PA5	M	General-purpose I/O port
	COM5		LCDC COM output pin
39	PA6	M	General-purpose I/O port
	COM6		LCDC COM output pin
40	PA7	M	General-purpose I/O port
	COM7		LCDC COM output pin
41	V _{SS}	—	Power supply pin (GND)
42	PF1	B	General-purpose I/O port
	X1		Main clock oscillation pin
43	PF0	B	General-purpose I/O port
	X0		Main clock oscillation pin

(Continued)

Pin no.	Pin name	I/O circuit type*	Function
44	C	—	Capacitor connection pin
45	PG2	C	General-purpose I/O port
	X1A		Subclock oscillation pin (32 kHz)
46	PG1	C	General-purpose I/O port
	X0A		Subclock oscillation pin (32 kHz)
47	V _{CC}	—	Power supply pin
48	PF2	A	General-purpose I/O port
	RST		Reset pin Dedicate reset pin for MB95F414H/F416H/F418H
49	P17	H	General-purpose I/O port
	CMPO		Voltage comparator output pin
50	PB0	M	General-purpose I/O port
	SEG00		LCDC SEG output pin
51	PB1	M	General-purpose I/O port
	SEG01		LCDC SEG output pin
52	PC0	M	General-purpose I/O port
	SEG02		LCDC SEG output pin
53	PC1	M	General-purpose I/O port
	SEG03		LCDC SEG output pin
54	PC2	M	General-purpose I/O port
	SEG04		LCDC SEG output pin
55	PC3	M	General-purpose I/O port
	SEG05		LCDC SEG output pin
56	PC4	M	General-purpose I/O port
	SEG06		LCDC SEG output pin
57	PC5	M	General-purpose I/O port
	SEG07		LCDC SEG output pin
58	PC6	M	General-purpose I/O port
	SEG08		LCDC SEG output pin
59	PC7	M	General-purpose I/O port
	SEG09		LCDC SEG output pin
60	P60	M	General-purpose I/O port
	SEG10		LCDC SEG output pin
61	P61	M	General-purpose I/O port
	SEG11		LCDC SEG output pin
62	P62	M	General-purpose I/O port
	SEG12		LCDC SEG output pin

(Continued)

Pin no.	Pin name	I/O circuit type*	Function
63	P63	M	General-purpose I/O port
	SEG13		LCDC SEG output pin
64	P64	M	General-purpose I/O port
	SEG14		LCDC SEG output pin
65	P65	M	General-purpose I/O port
	SEG15		LCDC SEG output pin
66	P66	M	General-purpose I/O port
	SEG16		LCDC SEG output pin
67	P67	M	General-purpose I/O port
	SEG17		LCDC SEG output pin
68	P43	M	General-purpose I/O port
	SEG18		LCDC SEG output pin
69	P42	M	General-purpose I/O port
	SEG19		LCDC SEG output pin
70	P41	M	General-purpose I/O port
	SEG20		LCDC SEG output pin
71	P40	M	General-purpose I/O port
	SEG21		LCDC SEG output pin
72	PE0	M	General-purpose I/O port
	SEG22		LCDC SEG output pin
73	PE1	M	General-purpose I/O port
	SEG23		LCDC SEG output pin
74	PE2	M	General-purpose I/O port
	SEG24		LCDC SEG output pin
75	PE3	M	General-purpose I/O port
	SEG25		LCDC SEG output pin
76	PE4	M	General-purpose I/O port
	SEG26		LCDC SEG output pin
77	PE5	M	General-purpose I/O port
	SEG27		LCDC SEG output pin
	TO11		8/16-bit composite timer ch. 1 output pin
78	PE6	M	General-purpose I/O port
	SEG28		LCDC SEG output pin
	TO10		8/16-bit composite timer ch. 1 output pin

(Continued)

(Continued)

Pin no.	Pin name	I/O circuit type*	Function
79	PE7	M	General-purpose I/O port
	SEG29		LCDC SEG output pin
	EC1		8/16-bit composite timer ch. 1 clock input pin
80	AV _{SS}	—	A/D converter power supply pin (GND)

*: For the I/O circuit types, see “8. I/O Circuit Type”.

7. Pin Description (MB95470H Series)

Pin no.	Pin name	I/O circuit type*	Function
1	AV _{CC}	—	A/D converter power supply pin
2	P07	S	General-purpose I/O port
	INT07		External interrupt input pin
	AN07		A/D analog input pin
	SEG22		LCDC SEG output pin
3	P06	S	General-purpose I/O port
	INT06		External interrupt input pin
	AN06		A/D analog input pin
	SEG23		LCDC SEG output pin
4	P05	S	General-purpose I/O port
	INT05		External interrupt input pin
	AN05		A/D analog input pin
	SEG24		LCDC SEG output pin
	UCK1		UART/SIO ch. 1 clock I/O pin
5	P04	V	General-purpose I/O port
	INT04		External interrupt input pin
	AN04		A/D analog input pin
	SEG25		LCDC SEG output pin
	UI1		UART/SIO ch. 1 data input pin
6	P03	S	General-purpose I/O port
	INT03		External interrupt input pin
	AN03		A/D analog input pin
	SEG26		LCDC SEG output pin
	UO1		UART/SIO ch. 1 data output pin
7	P02	S	General-purpose I/O port
	INT02		External interrupt input pin
	AN02		A/D analog input pin
	SEG27		LCDC SEG output pin
	UCK2		UART/SIO ch. 2 clock I/O pin
8	P01	V	General-purpose I/O port
	INT01		External interrupt input pin
	AN01		A/D analog input pin
	SEG28		LCDC SEG output pin
	TO00		8/16-bit composite timer ch. 0 output pin
	UI2		UART/SIO ch. 2 data input pin

(Continued)

Pin no.	Pin name	I/O circuit type*	Function
9	P00	S	General-purpose I/O port
	INT00		External interrupt input pin
	AN00		A/D analog input pin
	SEG29		LCDC SEG output pin
	UO2		UART/SIO ch. 2 data output pin
10	P16	M	General-purpose I/O port
	SEG30		LCDC SEG output pin
	PPG10		8/16-bit PPG ch. 1 output pin
11	P15	M	General-purpose I/O port
	SEG31		LCDC SEG output pin
	PPG11		8/16-bit PPG ch. 1 output pin
12	P14	H	General-purpose I/O port
	UCK0		UART/SIO ch. 0 clock I/O pin
	EC0		8/16-bit composite timer ch. 0 clock input pin
	T10		16-bit reload timer input pin
13	P13	H	General-purpose I/O port
	ADTG		A/D trigger input (ADTG) pin
	TO01		8/16-bit composite timer ch. 0 output pin
14	P12	D	General-purpose I/O port
	DBG		DBG input pin
15	P11	H	General-purpose I/O port
	UO0		UART/SIO ch. 0 data output pin
16	P10	G	General-purpose I/O port
	UI0		UART/SIO ch. 0 data input pin
	TO0		16-bit reload timer output pin
17	P23	I	General-purpose I/O port
	SDA		I ² C data I/O pin
18	P22	I	General-purpose I/O port
	SCL		I ² C clock I/O pin
19	P21	T	General-purpose I/O port
	PPG01		8/16-bit PPG ch. 0 output pin
	CMPP		Voltage comparator input pin
20	P20	T	General-purpose I/O port
	PPG00		8/16-bit PPG ch. 0 output pin
	CMPN		Voltage comparator input pin

(Continued)

Pin no.	Pin name	I/O circuit type*	Function
21	P90	R	General-purpose I/O port
	V4		LCDC drive power supply pin
22	P91	R	General-purpose I/O port
	V3		LCDC drive power supply pin
23	P92	R	General-purpose I/O port
	V2		LCDC drive power supply pin
24	P93	R	General-purpose I/O port
	V1		LCDC drive power supply pin
25	PA0	M	General-purpose I/O port
	COM0		LCDC COM output pin
26	PA1	M	General-purpose I/O port
	COM1		LCDC COM output pin
27	PA2	M	General-purpose I/O port
	COM2		LCDC COM output pin
28	PA3	M	General-purpose I/O port
	COM3		LCDC COM output pin
29	PA4	M	General-purpose I/O port
	COM4		LCDC COM output pin
30	PA5	M	General-purpose I/O port
	COM5		LCDC COM output pin
31	PA6	M	General-purpose I/O port
	COM6		LCDC COM output pin
32	PA7	M	General-purpose I/O port
	COM7		LCDC COM output pin
33	V _{SS}	—	Power supply pin (GND)
34	PF1	B	General-purpose I/O port
	X1		Main clock oscillation pin
35	PF0	B	General-purpose I/O port
	X0		Main clock oscillation pin
36	C	—	Capacitor connection pin
37	PG2	C	General-purpose I/O port
	X1A		Subclock oscillation pin (32 kHz)
38	PG1	C	General-purpose I/O port
	X0A		Subclock oscillation pin (32 kHz)
39	V _{CC}	—	Power supply pin
40	PF2	A	General-purpose I/O port
	RST		Reset pin Dedicated reset pin for MB95F474H/F476H/F478H

(Continued)

Pin no.	Pin name	I/O circuit type*	Function
41	P17	H	General-purpose I/O port
	CMPO		Voltage comparator output pin
42	PB0	M	General-purpose I/O port
	SEG00		LCDC SEG output pin
43	PB1	M	General-purpose I/O port
	SEG01		LCDC SEG output pin
44	PC0	M	General-purpose I/O port
	SEG02		LCDC SEG output pin
45	PC1	M	General-purpose I/O port
	SEG03		LCDC SEG output pin
46	PC2	M	General-purpose I/O port
	SEG04		LCDC SEG output pin
47	PC3	M	General-purpose I/O port
	SEG05		LCDC SEG output pin
48	P60	M	General-purpose I/O port
	SEG06		LCDC SEG output pin
49	P61	M	General-purpose I/O port
	SEG07		LCDC SEG output pin
50	P62	M	General-purpose I/O port
	SEG08		LCDC SEG output pin
51	P63	M	General-purpose I/O port
	SEG09		LCDC SEG output pin
52	P64	M	General-purpose I/O port
	SEG10		LCDC SEG output pin
53	P65	M	General-purpose I/O port
	SEG11		LCDC SEG output pin
54	P66	M	General-purpose I/O port
	SEG12		LCDC SEG output pin
55	P67	M	General-purpose I/O port
	SEG13		LCDC SEG output pin
56	PE0	M	General-purpose I/O port
	SEG14		LCDC SEG output pin
57	PE1	M	General-purpose I/O port
	SEG15		LCDC SEG output pin

(Continued)

(Continued)

Pin no.	Pin name	I/O circuit type*	Function
58	PE2	M	General-purpose I/O port
	SEG16		LCDC SEG output pin
59	PE3	M	General-purpose I/O port
	SEG17		LCDC SEG output pin
60	PE4	M	General-purpose I/O port
	SEG18		LCDC SEG output pin
61	PE5	M	General-purpose I/O port
	SEG19		LCDC SEG output pin
	TO11		8/16-bit composite timer ch. 1 output pin
62	PE6	M	General-purpose I/O port
	SEG20		LCDC SEG output pin
	TO10		8/16-bit composite timer ch. 1 output pin
63	PE7	M	General-purpose I/O port
	SEG21		LCDC SEG output pin
	EC1		8/16-bit composite timer ch. 1 clock input pin
64	AV _{SS}	—	A/D converter power supply pin (GND)

*: For the I/O circuit types, see "8. I/O Circuit Type".

8. I/O Circuit Type

Type	Circuit	Remarks
A		<ul style="list-style-type: none"> • N-ch open drain output • Hysteresis input • Reset output
B		<ul style="list-style-type: none"> • Oscillation circuit • High-speed side Feedback resistance: approx. 1 MΩ • CMOS output • Hysteresis input
C		<ul style="list-style-type: none"> • Oscillation circuit • Low-speed side Feedback resistance: approx. 10 MΩ • CMOS output • Hysteresis input • Pull-up control available

(Continued)

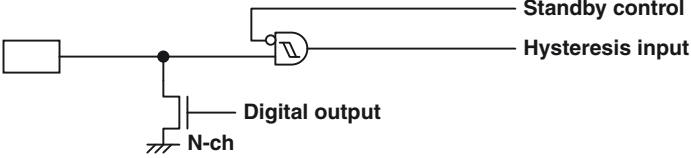
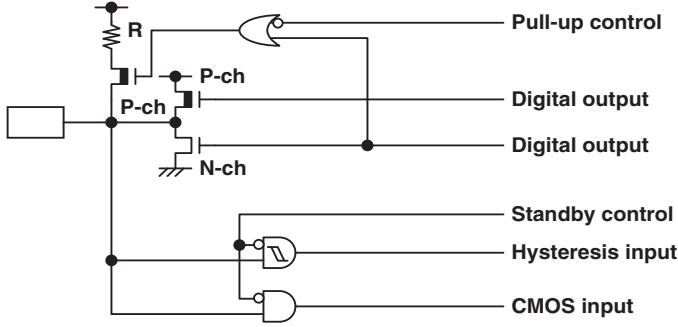
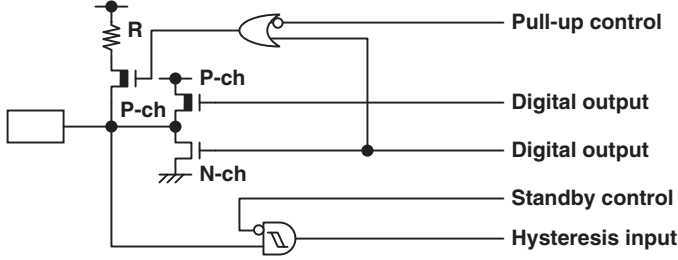
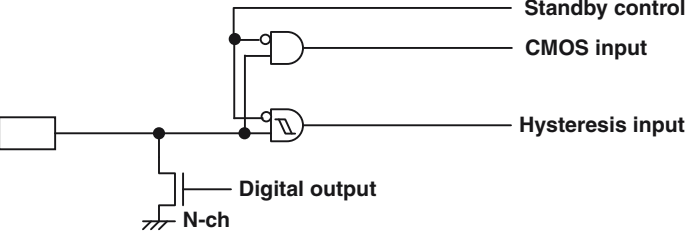
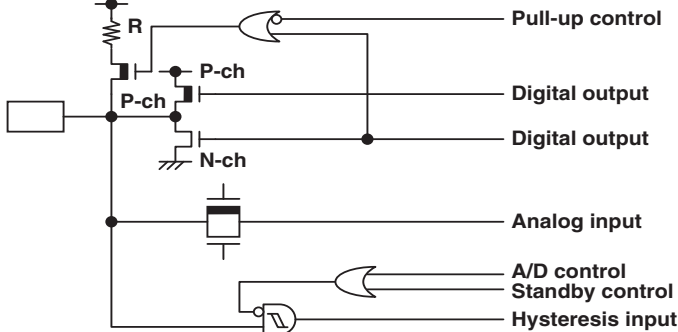
Type	Circuit	Remarks
D		<ul style="list-style-type: none"> • N-ch open drain output • Hysteresis input
G		<ul style="list-style-type: none"> • CMOS output • Hysteresis input • CMOS input • Pull-up control available
H		<ul style="list-style-type: none"> • CMOS output • Hysteresis input • Pull-up control available
I		<ul style="list-style-type: none"> • N-ch open drain output • CMOS input • Hysteresis input
J		<ul style="list-style-type: none"> • CMOS output • Hysteresis input • Analog input • Pull-up control available

(Continued)

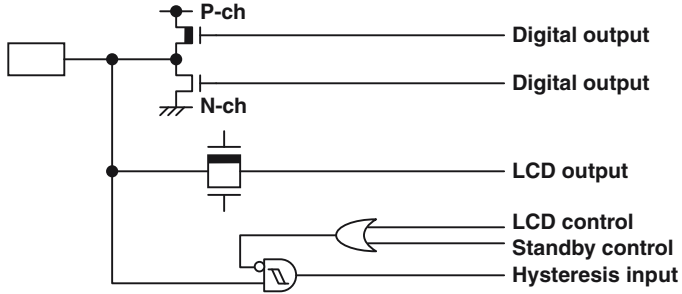
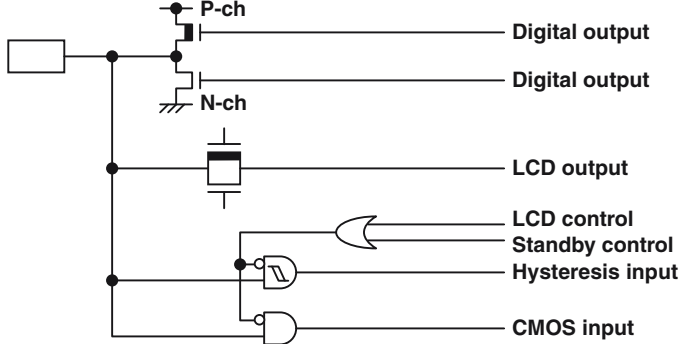
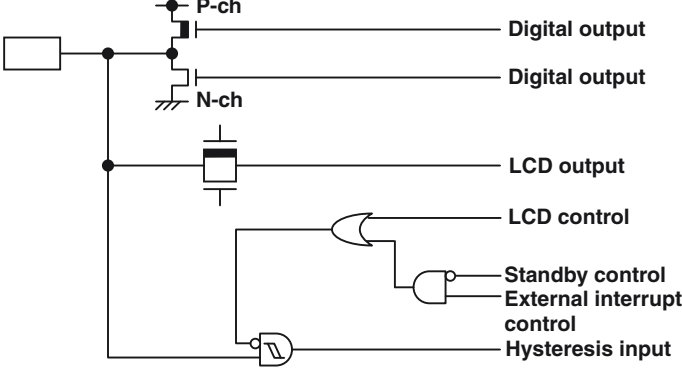
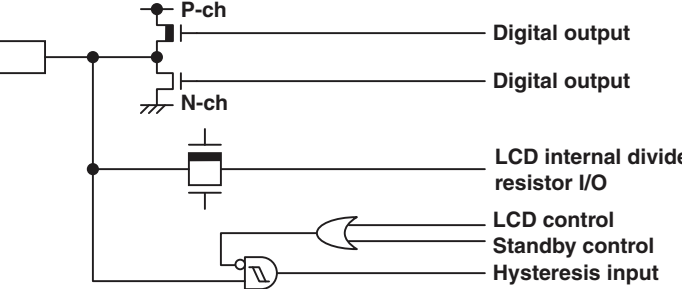
Type	Circuit	Remarks
M		<ul style="list-style-type: none"> • CMOS output • LCD output • Hysteresis input
N		<ul style="list-style-type: none"> • CMOS output • LCD output • Hysteresis input • CMOS input
Q		<ul style="list-style-type: none"> • CMOS output • LCD output • Hysteresis input
R		<ul style="list-style-type: none"> • CMOS output • LCD power supply • Hysteresis input

(Continued)

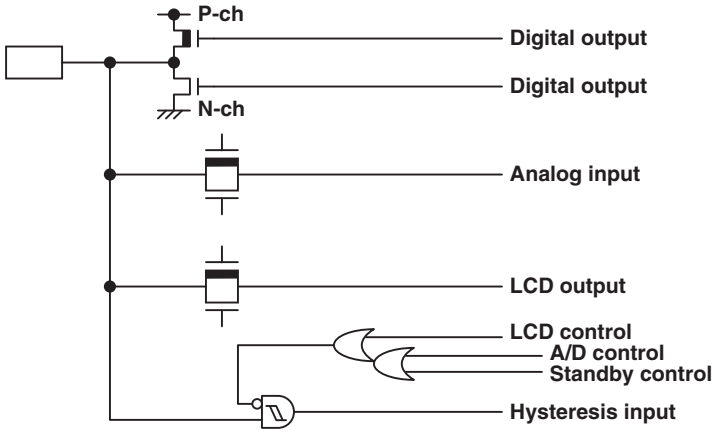
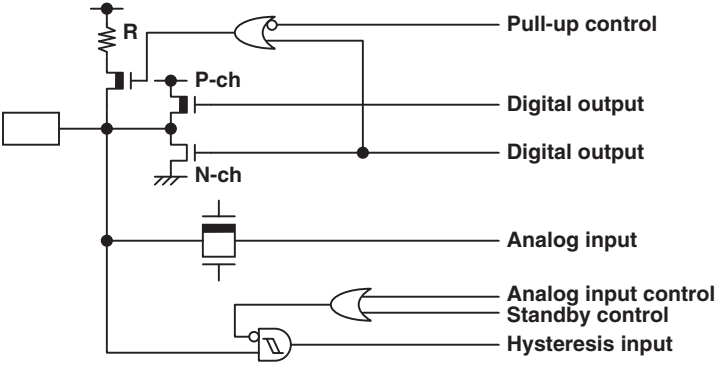
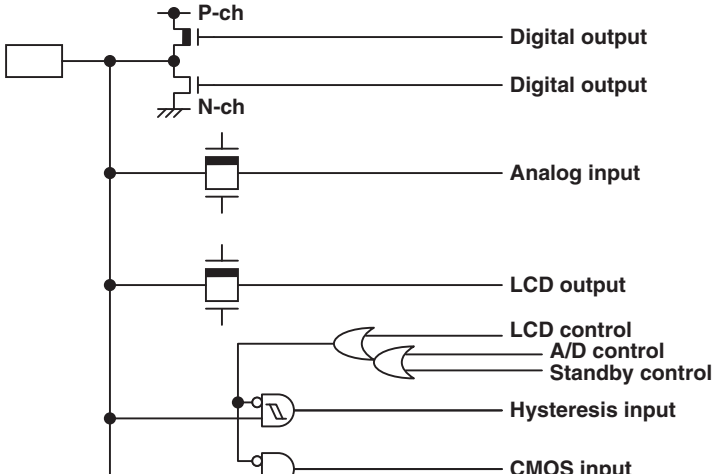
Type	Circuit	Remarks
S		<ul style="list-style-type: none"> • CMOS output • LCD output • Hysteresis input • Analog input
T		<ul style="list-style-type: none"> • CMOS output • Hysteresis input • Analog input • Pull-up control available
V		<ul style="list-style-type: none"> • CMOS output • LCD output • Hysteresis input • Analog input • CMOS input

(Continued)

(Continued)

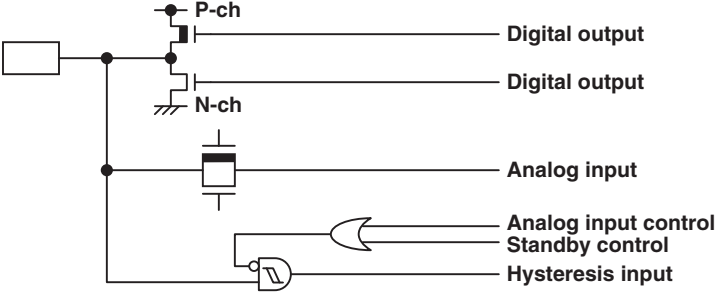
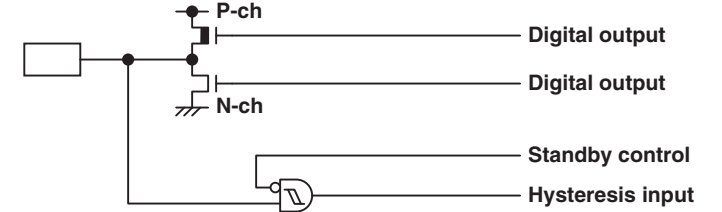
Type	Circuit	Remarks
W	 <p> P-ch Digital output Digital output N-ch Analog input Analog input control Standby control Hysteresis input </p>	<ul style="list-style-type: none"> • CMOS output • Hysteresis input • Analog input
Y	 <p> P-ch Digital output Digital output N-ch Standby control Hysteresis input </p>	<ul style="list-style-type: none"> • CMOS output • Hysteresis input

9. Notes on Device Handling

Preventing latch-ups

When using the device, ensure that the voltage applied does not exceed the maximum voltage rating.

In a CMOS IC, if a voltage higher than V_{CC} or a voltage lower than V_{SS} is applied to an input/output pin that is neither a medium-withstand voltage pin nor a high-withstand voltage pin, or if a voltage out of the rating range of power supply voltage mentioned in "17.1 Absolute Maximum Ratings" of "17. Electrical Characteristics" is applied to the V_{CC} pin or the V_{SS} pin, a latch-up may occur.

When a latch-up occurs, power supply current increases significantly, which may cause a component to be thermally destroyed.

Stabilizing supply voltage

Supply voltage must be stabilized.

A malfunction may occur when power supply voltage fluctuates rapidly even though the fluctuation is within the guaranteed operating range of the V_{CC} power supply voltage.

As a rule of voltage stabilization, suppress voltage fluctuation so that the fluctuation in V_{CC} ripple (p-p value) at the commercial frequency (50 Hz/60 Hz) does not exceed 10% of the standard V_{CC} value, and the transient fluctuation rate does not exceed 0.1 V/ms at a momentary fluctuation such as switching the power supply.

Notes on using the external clock

When an external clock is used, oscillation stabilization wait time is required for power-on reset, wake-up from subclock mode or stop mode.

10. Pin Connection

Treatment of unused input pins

If an unused input pin is left unconnected, a component may be permanently damaged due to malfunctions or latch-ups. Always pull up or pull down an unused input pin through a resistor of at least 2 k Ω . Set an unused input/output pin to the output state and leave it unconnected, or set it to the input state and treat it the same as an unused input pin. If there is an unused output pin, leave it unconnected.

Power supply pins

To reduce unnecessary electro-magnetic emission, prevent malfunctions of strobe signals due to an increase in the ground level, and conform to the total output current standard, always connect the V_{CC} pin and the V_{SS} pin to the power supply and ground outside the device. In addition, connect the current supply source to the V_{CC} pin and the V_{SS} pin with low impedance.

It is also advisable to connect a ceramic capacitor of approximately 0.1 μ F as a bypass capacitor between the V_{CC} pin and the V_{SS} pin at a location close to this device.

DBG pin

Connect the DBG pin directly to an external pull-up resistor.

To prevent the device from unintentionally entering the debug mode due to noise, minimize the distance between the DBG pin and the V_{CC} or V_{SS} pin when designing the layout of the printed circuit board.

The DBG pin should not stay at "L" level after power-on until the reset output is released.

\overline{RST} pin

Connect the \overline{RST} pin directly to an external pull-up resistor.

To prevent the device from unintentionally entering the reset mode due to noise, minimize the distance between the \overline{RST} pin and the V_{CC} or V_{SS} pin when designing the layout of the printed circuit board.

The PF2/ \overline{RST} pin functions as the reset input/output pin after power-on. In addition, the reset output function of the PF2/ \overline{RST} pin can be enabled by the RSTOE bit in the SYSC register, and the reset input function or the general purpose I/O function can be selected by the RSTEN bit in the SYSC register.

Analog power supply

Always set the same potential to AV_{CC} and V_{CC} pins. When V_{CC} is larger than AV_{CC} , the current may flow through the AN00 to AN07 pins.

Treatment of power supply pins on the A/D converter

Ensure that AV_{CC} is equal to V_{CC} and AV_{SS} equal to V_{SS} even when the A/D converter is not in use.

Noise riding on the AV_{CC} pin may cause accuracy degradation. Therefore, connect a ceramic capacitor of 0.1 μF (approx.) as a bypass capacitor between the AV_{CC} pin and the AV_{SS} pin in the vicinity of this device.

C pin

Use a ceramic capacitor or a capacitor with equivalent frequency characteristics. The bypass capacitor for the V_{CC} pin must have a capacitance larger than C_S . For the connection to a smoothing capacitor C_S , see the diagram below. To prevent the device from unintentionally entering an unknown mode due to noise, minimize the distance between the C pin and C_S and the distance between C_S and the V_{SS} pin when designing the layout of a printed circuit board.

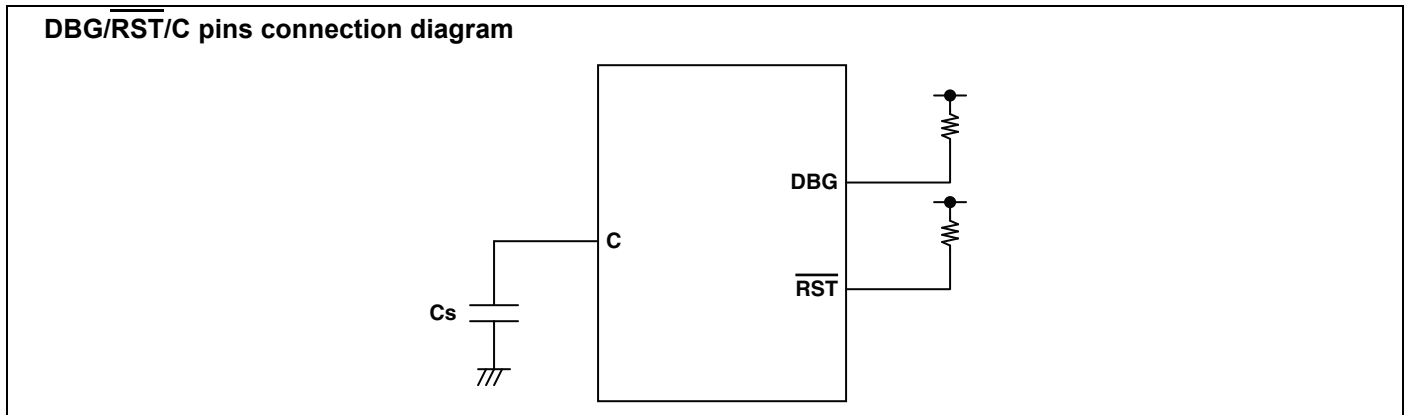

11. Block Diagram (MB95410H Series)

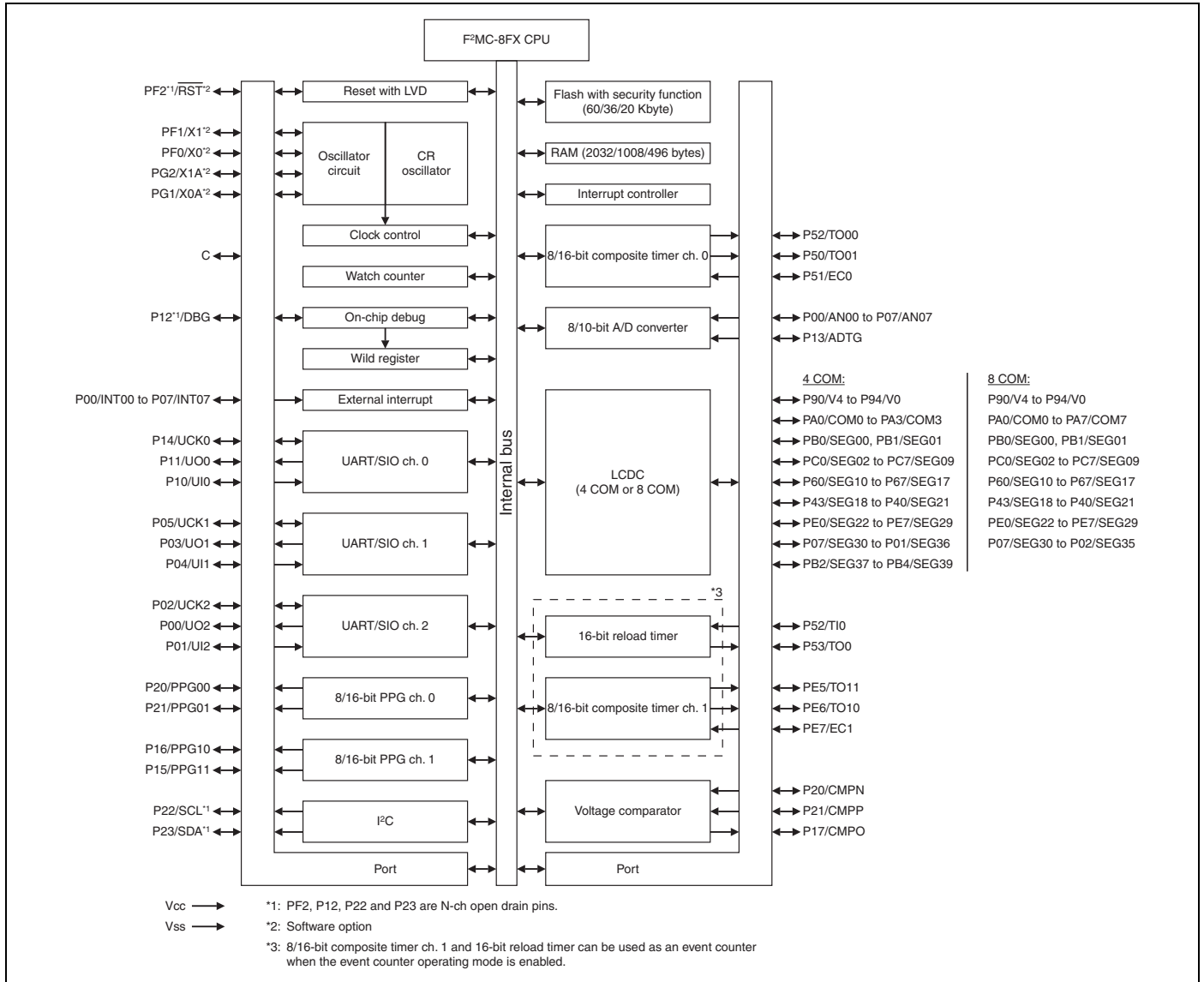

12. Block Diagram (MB95470H Series)

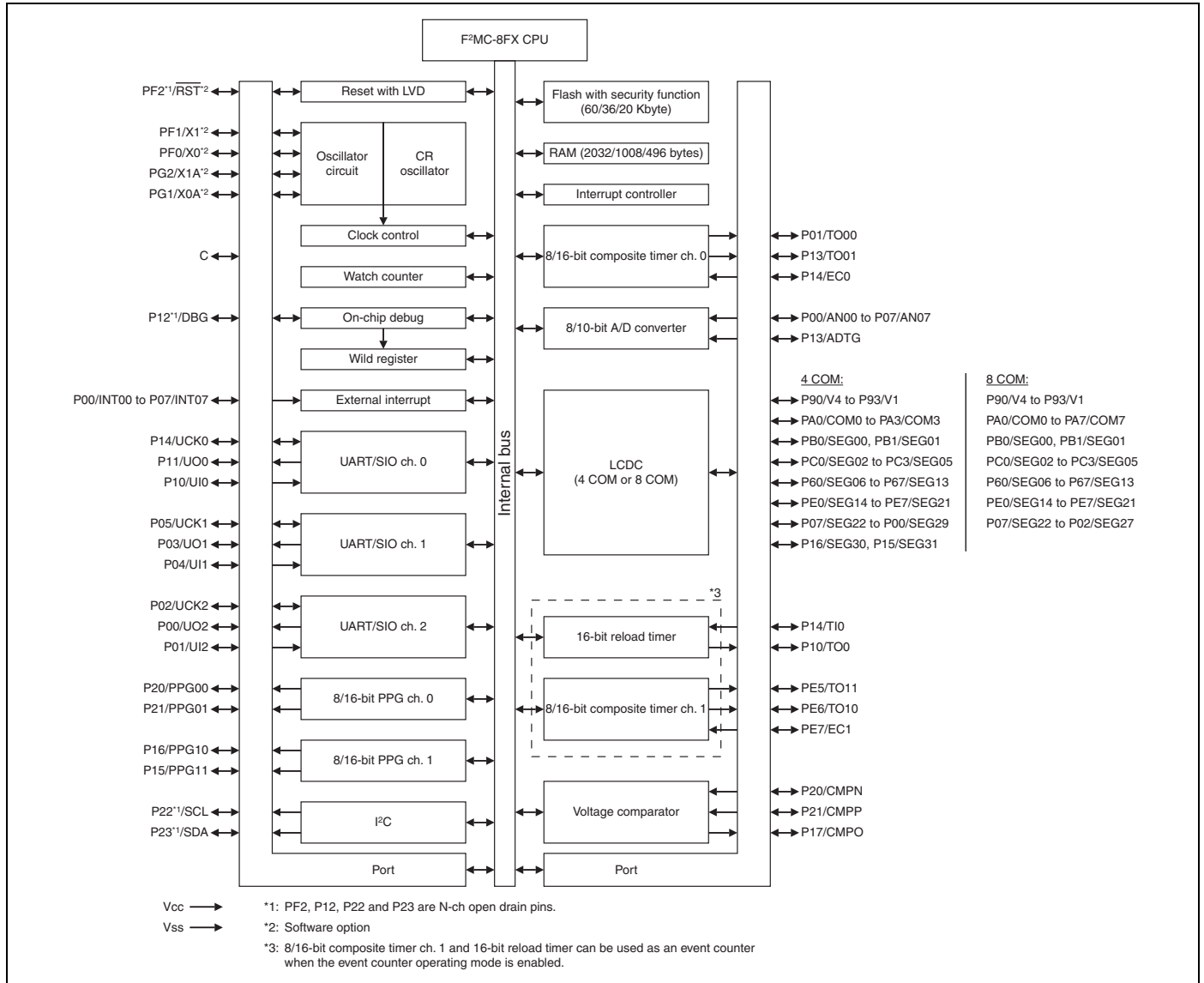

13. CPU Core

Memory Space

The memory space of the MB95410H/470H Series is 64 Kbyte in size, and consists of an I/O area, a data area, and a program area. The memory space includes areas intended for specific purposes such as general-purpose registers and a vector table. The memory maps of the MB95410H/470H Series are shown below.

Memory Maps

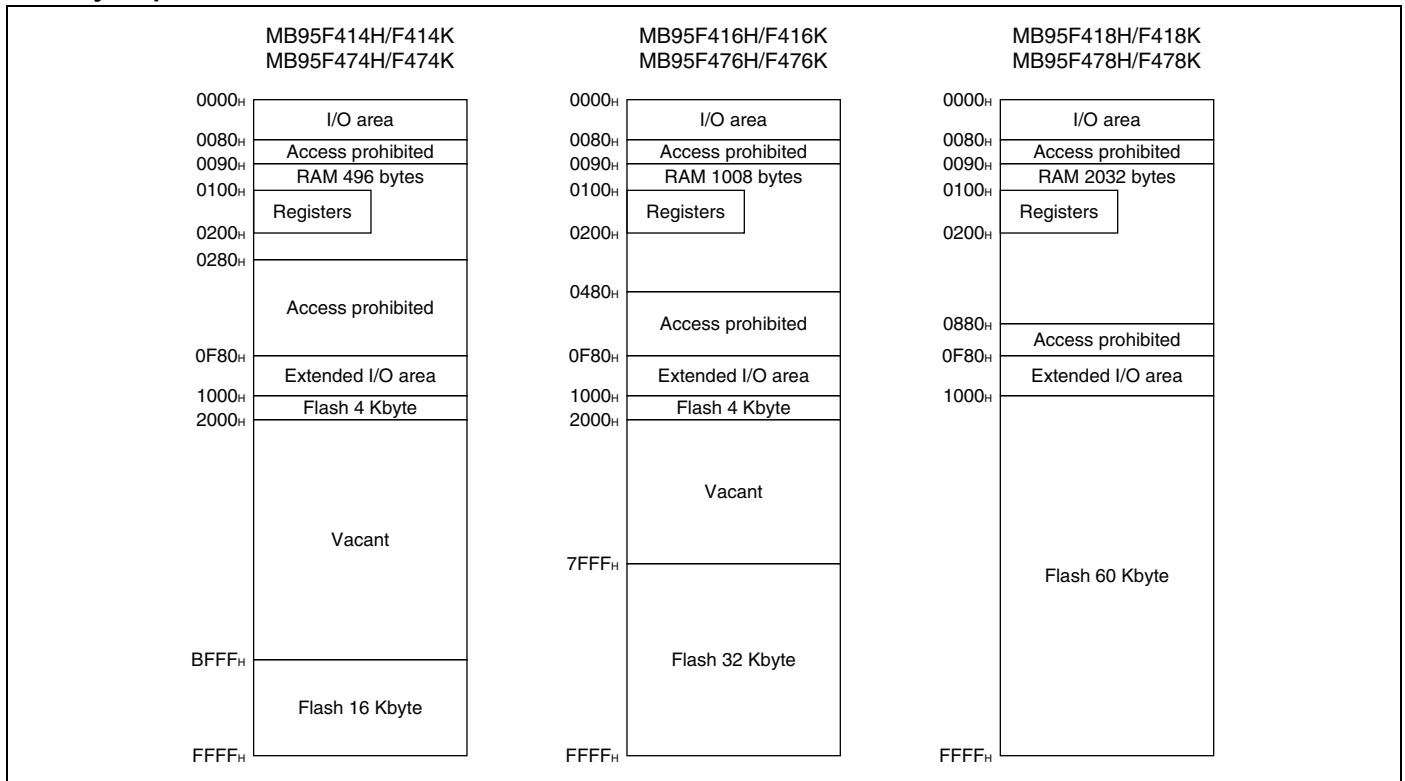

14. I/O Map (MB95410H Series)

Address	Register abbreviation	Register name	R/W	Initial value
0000 _H	PDR0	Port 0 data register	R/W	00000000 _B
0001 _H	DDR0	Port 0 direction register	R/W	00000000 _B
0002 _H	PDR1	Port 1 data register	R/W	00000000 _B
0003 _H	DDR1	Port 1 direction register	R/W	00000000 _B
0004 _H	—	(Disabled)	—	—
0005 _H	WATR	Oscillation stabilization wait time setting register	R/W	11111111 _B
0006 _H	PLLC	PLL control register	R/W	00000000 _B
0007 _H	SYCC	System clock control register	R/W	XXXXXX11 _B
0008 _H	STBC	Standby control register	R/W	0000XXXX _B
0009 _H	RSRR	Reset source register	R/W	00XXXXXX _B
000A _H	TBTC	Time-base timer control register	R/W	00000000 _B
000B _H	WPCR	Watch prescaler control register	R/W	00000000 _B
000C _H	WDTC	Watchdog timer control register	R/W	00000000 _B
000D _H	SYCC2	System clock control register 2	R/W	XX100011 _B
000E _H	PDR2	Port 2 data register	R/W	00000000 _B
000F _H	DDR2	Port 2 direction register	R/W	00000000 _B
0010 _H , 0011 _H	—	(Disabled)	—	—
0012 _H	PDR4	Port 4 data register	R/W	00000000 _B
0013 _H	DDR4	Port 4 direction register	R/W	00000000 _B
0014 _H	PDR5	Port 5 data register	R/W	00000000 _B
0015 _H	DDR5	Port 5 direction register	R/W	00000000 _B
0016 _H	PDR6	Port 6 data register	R/W	00000000 _B
0017 _H	DDR6	Port 6 direction register	R/W	00000000 _B
0018 _H to 001B _H	—	(Disabled)	—	—
001C _H	PDR9	Port 9 data register	R/W	00000000 _B
001D _H	DDR9	Port 9 direction register	R/W	00000000 _B
001E _H	PDRA	Port A data register	R/W	00000000 _B
001F _H	DDRA	Port A direction register	R/W	00000000 _B
0020 _H	PDRB	Port B data register	R/W	00000000 _B
0021 _H	DDRB	Port B direction register	R/W	00000000 _B
0022 _H	PDRC	Port C data register	R/W	00000000 _B
0023 _H	DDRC	Port C direction register	R/W	00000000 _B
0024 _H , 0025 _H	—	(Disabled)	—	—

(Continued)

Address	Register abbreviation	Register name	R/W	Initial value
0026 _H	PDRE	Port E data register	R/W	00000000 _B
0027 _H	DDRE	Port E direction register	R/W	00000000 _B
0028 _H	PDRF	Port F data register	R/W	00000000 _B
0029 _H	DDRF	Port F direction register	R/W	00000000 _B
002A _H	PDRG	Port G data register	R/W	00000000 _B
002B _H	DDRG	Port G direction register	R/W	00000000 _B
002C _H	—	(Disabled)	—	—
002D _H	PUL1	Port 1 pull-up register	R/W	00000000 _B
002E _H	PUL2	Port 2 pull-up register	R/W	00000000 _B
002F _H , 0030 _H	—	(Disabled)	—	—
0031 _H	PUL5	Port 5 pull-up register	R/W	00000000 _B
0032 _H to 0034 _H	—	(Disabled)	—	—
0035 _H	PULG	Port G pull-up register	R/W	00000000 _B
0036 _H	T01CR1	8/16-bit composite timer 01 status control register 1	R/W	00000000 _B
0037 _H	T00CR1	8/16-bit composite timer 00 status control register 1	R/W	00000000 _B
0038 _H	T11CR1	8/16-bit composite timer 11 status control register 1	R/W	00000000 _B
0039 _H	T10CR1	8/16-bit composite timer 10 status control register 1	R/W	00000000 _B
003A _H	PC01	8/16-bit PPG01 control register	R/W	00000000 _B
003B _H	PC00	8/16-bit PPG00 control register	R/W	00000000 _B
003C _H	PC11	8/16-bit PPG11 control register	R/W	00000000 _B
003D _H	PC10	8/16-bit PPG10 control register	R/W	00000000 _B
003E _H	TMCSRH0	16-bit reload timer control status register upper	R/W	00000000 _B
003F _H	TMCSRL0	16-bit reload timer control status register lower	R/W	00000000 _B
0040 _H to 0047 _H	—	(Disabled)	—	—
0048 _H	EIC00	External interrupt circuit control register ch. 0/ch. 1	R/W	00000000 _B
0049 _H	EIC10	External interrupt circuit control register ch. 2/ch. 3	R/W	00000000 _B
004A _H	EIC20	External interrupt circuit control register ch. 4/ch. 5	R/W	00000000 _B
004B _H	EIC30	External interrupt circuit control register ch. 6/ch. 7	R/W	00000000 _B
004C _H to 004E _H	—	(Disabled)	—	—
004F _H	LCDCC2	LCDC control register 2	R/W	00010100 _B
0050 _H	CMR0	Voltage comparator control register	R/W	000X0001 _B
0051 _H to 0055 _H	—	(Disabled)	—	—

(Continued)

Address	Register abbreviation	Register name	R/W	Initial value
0056 _H	SMC10	UART/SIO serial mode control register 1 ch. 0	R/W	00000000 _B
0057 _H	SMC20	UART/SIO serial mode control register 2 ch. 0	R/W	00100000 _B
0058 _H	SSR0	UART/SIO serial status register ch. 0	R/W	00000001 _B
0059 _H	TDR0	UART/SIO serial output data register ch. 0	R/W	00000000 _B
005A _H	RDR0	UART/SIO serial input data register ch. 0	R	00000000 _B
005B _H	SMC11	UART/SIO serial mode control register 1 ch. 1	R/W	00000000 _B
005C _H	SMC21	UART/SIO serial mode control register 2 ch. 1	R/W	00100000 _B
005D _H	SSR1	UART/SIO serial status register ch. 1	R/W	00000001 _B
005E _H	TDR1	UART/SIO serial output data register ch. 1	R/W	00000000 _B
005F _H	RDR1	UART/SIO serial input data register ch. 1	R	00000000 _B
0060 _H	IBCR00	I ² C bus control register 0	R/W	00000001 _B
0061 _H	IBCR10	I ² C bus control register 1	R/W	00000000 _B
0062 _H	IBCR0	I ² C bus status register	R	00000000 _B
0063 _H	IDDR0	I ² C data register	R/W	00000000 _B
0064 _H	IAAR0	I ² C address register	R/W	00000000 _B
0065 _H	ICCR0	I ² C clock control register	R/W	00000000 _B
0066 _H	SMC12	UART/SIO serial mode control register 1 ch. 2	R/W	00000000 _B
0067 _H	SMC22	UART/SIO serial mode control register 2 ch. 2	R/W	00100000 _B
0068 _H	SSR2	UART/SIO serial status register ch. 2	R/W	00000001 _B
0069 _H	TDR2	UART/SIO serial output data register ch. 2	R/W	00000000 _B
006A _H	RDR2	UART/SIO serial input data register ch. 2	R	00000000 _B
006B _H	—	(Disabled)	—	—
006C _H	ADC1	8/10-bit A/D converter control register 1	R/W	00000000 _B
006D _H	ADC2	8/10-bit A/D converter control register 2	R/W	00000000 _B
006E _H	ADDH	8/10-bit A/D converter data register upper	R/W	00000000 _B
006F _H	ADDL	8/10-bit A/D converter data register lower	R/W	00000000 _B
0070 _H	WCSR	Watch counter status register	R/W	00000000 _B
0071 _H	FSR2	Flash memory status register 2	R/W	00000000 _B
0072 _H	FSR	Flash memory status register	R/W	000X0000 _B
0073 _H	SWRE0	Flash memory sector write control register 0	R/W	00000000 _B
0074 _H	FSR3	Flash memory status register 3	R	00000000 _B
0075 _H	—	(Disabled)	—	—
0076 _H	WREN	Wild register address compare enable register	R/W	00000000 _B
0077 _H	WROR	Wild register data test setting register	R/W	00000000 _B
0078 _H	—	Mirror of register bank pointer (RP) and direct bank pointer (DP)	—	—

(Continued)

Address	Register abbreviation	Register name	R/W	Initial value
0079 _H	ILR0	Interrupt level setting register 0	R/W	11111111 _B
007A _H	ILR1	Interrupt level setting register 1	R/W	11111111 _B
007B _H	ILR2	Interrupt level setting register 2	R/W	11111111 _B
007C _H	ILR3	Interrupt level setting register 3	R/W	11111111 _B
007D _H	ILR4	Interrupt level setting register 4	R/W	11111111 _B
007E _H	ILR5	Interrupt level setting register 5	R/W	11111111 _B
007F _H	—	(Disabled)	—	—
0F80 _H	WRARH0	Wild register address setting register (upper) ch. 0	R/W	00000000 _B
0F81 _H	WRARL0	Wild register address setting register (lower) ch. 0	R/W	00000000 _B
0F82 _H	WRDR0	Wild register data setting register ch. 0	R/W	00000000 _B
0F83 _H	WRARH1	Wild register address setting register (upper) ch. 1	R/W	00000000 _B
0F84 _H	WRARL1	Wild register address setting register (lower) ch. 1	R/W	00000000 _B
0F85 _H	WRDR1	Wild register data setting register ch. 1	R/W	00000000 _B
0F86 _H	WRARH2	Wild register address setting register (upper) ch. 2	R/W	00000000 _B
0F87 _H	WRARL2	Wild register address setting register (lower) ch. 2	R/W	00000000 _B
0F88 _H	WRDR2	Wild register data setting register ch. 2	R/W	00000000 _B
0F89 _H to 0F91 _H	—	(Disabled)	—	—
0F92 _H	T01CR0	8/16-bit composite timer 01 status control register 0	R/W	00000000 _B
0F93 _H	T00CR0	8/16-bit composite timer 00 status control register 0	R/W	00000000 _B
0F94 _H	T01DR	8/16-bit composite timer 01 data register	R/W	00000000 _B
0F95 _H	T00DR	8/16-bit composite timer 00 data register	R/W	00000000 _B
0F96 _H	TMCR0	8/16-bit composite timer 00/01 timer mode control register	R/W	00000000 _B
0F97 _H	T11CR0	8/16-bit composite timer 11 status control register 0	R/W	00000000 _B
0F98 _H	T10CR0	8/16-bit composite timer 10 status control register 0	R/W	00000000 _B
0F99 _H	T11DR	8/16-bit composite timer 11 data register	R/W	00000000 _B
0F9A _H	T10DR	8/16-bit composite timer 10 data register	R/W	00000000 _B
0F9B _H	TMCR1	8/16-bit composite timer 10/11 timer mode control register	R/W	00000000 _B
0F9C _H	PPS01	8/16-bit PPG01 cycle setting buffer register	R/W	11111111 _B
0F9D _H	PPS00	8/16-bit PPG00 cycle setting buffer register	R/W	11111111 _B
0F9E _H	PDS01	8/16-bit PPG01 duty setting buffer register	R/W	11111111 _B
0F9F _H	PDS00	8/16-bit PPG00 duty setting buffer register	R/W	11111111 _B
0FA0 _H	PPS11	8/16-bit PPG11 cycle setting buffer register	R/W	11111111 _B
0FA1 _H	PPS10	8/16-bit PPG10 cycle setting buffer register	R/W	11111111 _B
0FA2 _H	PDS11	8/16-bit PPG11 duty setting buffer register	R/W	11111111 _B
0FA3 _H	PDS10	8/16-bit PPG10 duty setting buffer register	R/W	11111111 _B

(Continued)

Address	Register abbreviation	Register name	R/W	Initial value
0FA4 _H	PPGS	8/16-bit PPG start register	R/W	00000000 _B
0FA5 _H	REVC	8/16-bit PPG output inversion register	R/W	00000000 _B
0FA6 _H	TMRH0	16-bit reload timer timer register upper	R/W	00000000 _B
	TMRLRH0	16-bit reload timer reload register upper	R/W	00000000 _B
0FA7 _H	TMRL0	16-bit reload timer timer register lower	R/W	00000000 _B
	TMRLRL0	16-bit reload timer reload register lower	R/W	00000000 _B
0FA8 _H	PSSR0	UART/SIO dedicated baud rate generator prescaler select register ch. 0	R/W	00000000 _B
0FA9 _H	BRSR0	UART/SIO dedicated baud rate generator baud rate setting register ch. 0	R/W	00000000 _B
0FAA _H	PSSR1	UART/SIO dedicated baud rate generator prescaler select register ch. 1	R/W	00000000 _B
0FAB _H	BRSR1	UART/SIO dedicated baud rate generator baud rate setting register ch. 1	R/W	00000000 _B
0FAC _H	PSSR2	UART/SIO dedicated baud rate generator prescaler select register ch. 2	R/W	00000000 _B
0FAD _H	BRSR2	UART/SIO dedicated baud rate generator baud rate setting register ch. 2	R/W	00000000 _B
0FAE _H	—	(Disabled)	—	—
0FAF _H	AIDRL	A/D input disable register (lower)	R/W	00000000 _B
0FB0 _H	LCDCC1	LCDC control register 1	R/W	00000000 _B
0FB1 _H	—	(Disabled)	—	—
0FB2 _H	LCDCE1	LCDC enable register 1	R/W	00111110 _B
0FB3 _H	LCDCE2	LCDC enable register 2	R/W	00000000 _B
0FB4 _H	LCDCE3	LCDC enable register 3	R/W	00000000 _B
0FB5 _H	LCDCE4	LCDC enable register 4	R/W	00000000 _B
0FB6 _H	LCDCE5	LCDC enable register 5	R/W	00000000 _B
0FB7 _H	LCDCE6	LCDC enable register 6	R/W	00000000 _B
0FB8 _H	LCDCE7	LCDC enable register 7	R/W	00000000 _B
0FB9 _H	LCDCB1	LCDC blinking setting register 1	R/W	00000000 _B
0FBA _H	LCDCB2	LCDC blinking setting register 2	R/W	00000000 _B
0FBB _H , 0FBC _H	—	(Disabled)	—	—
0FBD _H to 0FE0 _H	LCDRAM	LCDC display RAM (36 bytes)	R/W	00000000 _B
0FE1 _H	—	(Disabled)	—	—
0FE2 _H	EVCR	Event counter control register	R/W	00000000 _B
0FE3 _H	WCDR	Watch counter data register	R/W	00111111 _B

(Continued)

(Continued)

Address	Register abbreviation	Register name	R/W	Initial value
0FE4 _H	CRTH	Main CR clock trimming register (upper)	R/W	0XXXXXXX _B
0FE5 _H	CRTL	Main CR clock trimming register (lower)	R/W	00XXXXXX _B
0FE6 _H , 0FE7 _H	—	(Disabled)	—	—
0FE8 _H	SYSC	System configuration register	R/W	11000011 _B
0FE9 _H	CMCR	Clock monitoring control register	R/W	XX000000 _B
0FEA _H	CMDR	Clock monitoring data register	R	00000000 _B
0FEB _H	WDTH	Watchdog timer selection ID register (upper)	R	XXXXXXXX _B
0FEC _H	WDTL	Watchdog timer selection ID register (lower)	R	XXXXXXXX _B
0FED _H	—	(Disabled)	—	—
0FEE _H	ILSR	Input level select register	R/W	00000000 _B
0FEF _H	WICR	Interrupt pin control register	R/W	01000000 _B
0FF0 _H to 0FFF _H	—	(Disabled)	—	—

R/W access symbols

R/W : Readable / Writable

R : Read only

Initial value symbols

0 : The initial value of this bit is "0".

1 : The initial value of this bit is "1".

X : The initial value of this bit is indeterminate.

Note: Do not write to an address that is "(Disabled)". If a "(Disabled)" address is read, an indeterminate value is returned.

15. I/O Map (MB95470H Series)

Address	Register abbreviation	Register name	R/W	Initial value
0000 _H	PDR0	Port 0 data register	R/W	00000000 _B
0001 _H	DDR0	Port 0 direction register	R/W	00000000 _B
0002 _H	PDR1	Port 1 data register	R/W	00000000 _B
0003 _H	DDR1	Port 1 direction register	R/W	00000000 _B
0004 _H	—	(Disabled)	—	—
0005 _H	WATR	Oscillation stabilization wait time setting register	R/W	11111111 _B
0006 _H	PLLC	PLL control register	R/W	00000000 _B
0007 _H	SYCC	System clock control register	R/W	XXXXXX11 _B
0008 _H	STBC	Standby control register	R/W	0000XXX _B
0009 _H	RSRR	Reset source register	R/W	000XXXX _B
000A _H	TBTC	Time-base timer control register	R/W	00000000 _B
000B _H	WPCR	Watch prescaler control register	R/W	00000000 _B
000C _H	WDTC	Watchdog timer control register	R/W	00000000 _B
000D _H	SYCC2	System clock control register 2	R/W	XX100011 _B
000E _H	PDR2	Port 2 data register	R/W	00000000 _B
000F _H	DDR2	Port 2 direction register	R/W	00000000 _B
0010 _H to 0015 _H	—	(Disabled)	—	—
0016 _H	PDR6	Port 6 data register	R/W	00000000 _B
0017 _H	DDR6	Port 6 direction register	R/W	00000000 _B
0018 _H to 001B _H	—	(Disabled)	—	—
001C _H	PDR9	Port 9 data register	R/W	00000000 _B
001D _H	DDR9	Port 9 direction register	R/W	00000000 _B
001E _H	PDRA	Port A data register	R/W	00000000 _B
001F _H	DDRA	Port A direction register	R/W	00000000 _B
0020 _H	PDRB	Port B data register	R/W	00000000 _B
0021 _H	DDRB	Port B direction register	R/W	00000000 _B
0022 _H	PDRC	Port C data register	R/W	00000000 _B
0023 _H	DDRC	Port C direction register	R/W	00000000 _B
0024 _H , 0025 _H	—	(Disabled)	—	—
0026 _H	PDRE	Port E data register	R/W	00000000 _B
0027 _H	DDRE	Port E direction register	R/W	00000000 _B
0028 _H	PDRF	Port F data register	R/W	00000000 _B
0029 _H	DDRF	Port F direction register	R/W	00000000 _B
002A _H	PDRG	Port G data register	R/W	00000000 _B
002B _H	DDRG	Port G direction register	R/W	00000000 _B
002C _H	—	(Disabled)	—	—

(Continued)

Address	Register abbreviation	Register name	R/W	Initial value
002D _H	PUL1	Port 1 pull-up register	R/W	00000000 _B
002E _H	PUL2	Port 2 pull-up register	R/W	00000000 _B
002F _H to 0034 _H	—	(Disabled)	—	—
0035 _H	PULG	Port G pull-up register	R/W	00000000 _B
0036 _H	T01CR1	8/16-bit composite timer 01 status control register 1	R/W	00000000 _B
0037 _H	T00CR1	8/16-bit composite timer 00 status control register 1	R/W	00000000 _B
0038 _H	T11CR1	8/16-bit composite timer 11 status control register 1	R/W	00000000 _B
0039 _H	T10CR1	8/16-bit composite timer 10 status control register 1	R/W	00000000 _B
003A _H	PC01	8/16-bit PPG01 control register	R/W	00000000 _B
003B _H	PC00	8/16-bit PPG00 control register	R/W	00000000 _B
003C _H	PC11	8/16-bit PPG11 control register	R/W	00000000 _B
003D _H	PC10	8/16-bit PPG10 control register	R/W	00000000 _B
003E _H	TMCSRH0	16-bit reload timer control status register upper	R/W	00000000 _B
003F _H	TMCSRL0	16-bit reload timer control status register lower	R/W	00000000 _B
0040 _H to 0047 _H	—	(Disabled)	—	—
0048 _H	EIC00	External interrupt circuit control register ch. 0/ch. 1	R/W	00000000 _B
0049 _H	EIC10	External interrupt circuit control register ch. 2/ch. 3	R/W	00000000 _B
004A _H	EIC20	External interrupt circuit control register ch. 4/ch. 5	R/W	00000000 _B
004B _H	EIC30	External interrupt circuit control register ch. 6/ch. 7	R/W	00000000 _B
004C _H to 004E _H	—	(Disabled)	—	—
004F _H	LCDCC2	LCDC control register 2	R/W	00010100 _B
0050 _H	CMR0	Voltage comparator control register	R/W	000X0001 _B
0051 _H to 0055 _H	—	(Disabled)	—	—
0056 _H	SMC10	UART/SIO serial mode control register 1 ch. 0	R/W	00000000 _B
0057 _H	SMC20	UART/SIO serial mode control register 2 ch. 0	R/W	00100000 _B
0058 _H	SSR0	UART/SIO serial status register ch. 0	R/W	00000001 _B
0059 _H	TDR0	UART/SIO serial output data register ch. 0	R/W	00000000 _B
005A _H	RDR0	UART/SIO serial input data register ch. 0	R	00000000 _B
005B _H	SMC11	UART/SIO serial mode control register 1 ch. 1	R/W	00000000 _B
005C _H	SMC21	UART/SIO serial mode control register 2 ch. 1	R/W	00100000 _B
005D _H	SSR1	UART/SIO serial status register ch. 1	R/W	00000001 _B
005E _H	TDR1	UART/SIO serial output data register ch. 1	R/W	00000000 _B

(Continued)

Address	Register abbreviation	Register name	R/W	Initial value
005F _H	RDR1	UART/SIO serial input data register ch. 1	R	00000000 _B
0060 _H	IBCR00	I ² C bus control register 0	R/W	00000001 _B
0061 _H	IBCR10	I ² C bus control register 1	R/W	00000000 _B
0062 _H	IBCR0	I ² C bus status register	R	00000000 _B
0063 _H	IDDR0	I ² C data register	R/W	00000000 _B
0064 _H	IAAR0	I ² C address register	R/W	00000000 _B
0065 _H	ICCR0	I ² C clock control register	R/W	00000000 _B
0066 _H	SMC12	UART/SIO serial mode control register 1 ch. 2	R/W	00000000 _B
0067 _H	SMC22	UART/SIO serial mode control register 2 ch. 2	R/W	00100000 _B
0068 _H	SSR2	UART/SIO serial status register ch. 2	R/W	00000001 _B
0069 _H	TDR2	UART/SIO serial output data register ch. 2	R/W	00000000 _B
006A _H	RDR2	UART/SIO serial input data register ch. 2	R	00000000 _B
006B _H	—	(Disabled)	—	—
006C _H	ADC1	8/10-bit A/D converter control register 1	R/W	00000000 _B
006D _H	ADC2	8/10-bit A/D converter control register 2	R/W	00000000 _B
006E _H	ADDH	8/10-bit A/D converter data register upper	R/W	00000000 _B
006F _H	ADDL	8/10-bit A/D converter data register lower	R/W	00000000 _B
0070 _H	WCSR	Watch counter status register	R/W	00000000 _B
0071 _H	FSR2	Flash memory status register 2	R/W	00000000 _B
0072 _H	FSR	Flash memory status register	R/W	000X0000 _B
0073 _H	SWRE0	Flash memory sector write control register 0	R/W	00000000 _B
0074 _H	FSR3	Flash memory status register 3	R	00000000 _B
0075 _H	—	(Disabled)	—	—
0076 _H	WREN	Wild register address compare enable register	R/W	00000000 _B
0077 _H	WROR	Wild register data test setting register	R/W	00000000 _B
0078 _H	—	Mirror of register bank pointer (RP) and direct bank pointer (DP)	—	—
0079 _H	ILR0	Interrupt level setting register 0	R/W	11111111 _B
007A _H	ILR1	Interrupt level setting register 1	R/W	11111111 _B
007B _H	ILR2	Interrupt level setting register 2	R/W	11111111 _B
007C _H	ILR3	Interrupt level setting register 3	R/W	11111111 _B
007D _H	ILR4	Interrupt level setting register 4	R/W	11111111 _B
007E _H	ILR5	Interrupt level setting register 5	R/W	11111111 _B
007F _H	—	(Disabled)	—	—
0F80 _H	WRARH0	Wild register address setting register (upper) ch. 0	R/W	00000000 _B
0F81 _H	WRARL0	Wild register address setting register (lower) ch. 0	R/W	00000000 _B
0F82 _H	WRDR0	Wild register data setting register ch. 0	R/W	00000000 _B

(Continued)

Address	Register abbreviation	Register name	R/W	Initial value
0F83 _H	WRARH1	Wild register address setting register (upper) ch. 1	R/W	00000000 _B
0F84 _H	WRARL1	Wild register address setting register (lower) ch. 1	R/W	00000000 _B
0F85 _H	WRDR1	Wild register data setting register ch. 1	R/W	00000000 _B
0F86 _H	WRARH2	Wild register address setting register (upper) ch. 2	R/W	00000000 _B
0F87 _H	WRARL2	Wild register address setting register (lower) ch. 2	R/W	00000000 _B
0F88 _H	WRDR2	Wild register data setting register ch. 2	R/W	00000000 _B
0F89 _H to 0F91 _H	—	(Disabled)	—	—
0F92 _H	T01CR0	8/16-bit composite timer 01 status control register 0	R/W	00000000 _B
0F93 _H	T00CR0	8/16-bit composite timer 00 status control register 0	R/W	00000000 _B
0F94 _H	T01DR	8/16-bit composite timer 01 data register	R/W	00000000 _B
0F95 _H	T00DR	8/16-bit composite timer 00 data register	R/W	00000000 _B
0F96 _H	TMCR0	8/16-bit composite timer 00/01 timer mode control register	R/W	00000000 _B
0F97 _H	T11CR0	8/16-bit composite timer 11 status control register 0	R/W	00000000 _B
0F98 _H	T10CR0	8/16-bit composite timer 10 status control register 0	R/W	00000000 _B
0F99 _H	T11DR	8/16-bit composite timer 11 data register	R/W	00000000 _B
0F9A _H	T10DR	8/16-bit composite timer 10 data register	R/W	00000000 _B
0F9B _H	TMCR1	8/16-bit composite timer 10/11 timer mode control register	R/W	00000000 _B
0F9C _H	PPS01	8/16-bit PPG01 cycle setting buffer register	R/W	11111111 _B
0F9D _H	PPS00	8/16-bit PPG00 cycle setting buffer register	R/W	11111111 _B
0F9E _H	PDS01	8/16-bit PPG01 duty setting buffer register	R/W	11111111 _B
0F9F _H	PDS00	8/16-bit PPG00 duty setting buffer register	R/W	11111111 _B
0FA0 _H	PPS11	8/16-bit PPG11 cycle setting buffer register	R/W	11111111 _B
0FA1 _H	PPS10	8/16-bit PPG10 cycle setting buffer register	R/W	11111111 _B
0FA2 _H	PDS11	8/16-bit PPG11 duty setting buffer register	R/W	11111111 _B
0FA3 _H	PDS10	8/16-bit PPG10 duty setting buffer register	R/W	11111111 _B
0FA4 _H	PPGS	8/16-bit PPG start register	R/W	00000000 _B
0FA5 _H	REVC	8/16-bit PPG output inversion register	R/W	00000000 _B
0FA6 _H	TMRH0	16-bit reload timer timer register upper	R/W	00000000 _B
	TMRLRH0	16-bit reload timer reload register upper	R/W	00000000 _B
0FA7 _H	TMRL0	16-bit reload timer timer register lower	R/W	00000000 _B
	TMRLRL0	16-bit reload timer reload register lower	R/W	00000000 _B
0FA8 _H	PSSR0	UART/SIO dedicated baud rate generator prescaler select register ch. 0	R/W	00000000 _B
0FA9 _H	BRSR0	UART/SIO dedicated baud rate generator baud rate setting register ch. 0	R/W	00000000 _B
0FAA _H	PSSR1	UART/SIO dedicated baud rate generator prescaler select register ch. 1	R/W	00000000 _B
0FAB _H	BRSR1	UART/SIO dedicated baud rate generator baud rate setting register ch. 1	R/W	00000000 _B

(Continued)

Address	Register abbreviation	Register name	R/W	Initial value
0FAC _H	PSSR2	UART/SIO dedicated baud rate generator prescaler select register ch. 2	R/W	00000000 _B
0FAD _H	BRSR2	UART/SIO dedicated baud rate generator baud rate setting register ch. 2	R/W	00000000 _B
0FAE _H	—	(Disabled)	—	—
0FAF _H	AIDRL	A/D input disable register (lower)	R/W	00000000 _B
0FB0 _H	LCDCC1	LCDC control register 1	R/W	00000000 _B
0FB1 _H	—	(Disabled)	—	—
0FB2 _H	LCDCE1	LCDC enable register 1	R/W	00111100 _B
0FB3 _H	LCDCE2	LCDC enable register 2	R/W	00000000 _B
0FB4 _H	LCDCE3	LCDC enable register 3	R/W	00000000 _B
0FB5 _H	LCDCE4	LCDC enable register 4	R/W	00000000 _B
0FB6 _H	LCDCE5	LCDC enable register 5	R/W	00000000 _B
0FB7 _H	LCDCE6	LCDC enable register 6	R/W	00000000 _B
0FB8 _H	—	(Disabled)	—	—
0FB9 _H	LCDCB1	LCDC blinking setting register 1	R/W	00000000 _B
0FBA _H	LCDCB2	LCDC blinking setting register 2	R/W	00000000 _B
0FBB _H , 0FBC _H	—	(Disabled)	—	—
0FBD _H to 0FD8 _H	LCDRAM	LCDC display RAM (28 bytes)	R/W	00000000 _B
0FD9 _H to 0FE1 _H	—	(Disabled)	—	—
0FE2 _H	EVCR	Event counter control register	R/W	00000000 _B
0FE3 _H	WCDR	Watch counter data register	R/W	00111111 _B
0FE4 _H	CRT _H	Main CR clock trimming register (upper)	R/W	0XXXXXXXX _B
0FE5 _H	CRT _L	Main CR clock trimming register (lower)	R/W	00XXXXXXXX _B
0FE6 _H , 0FE7 _H	—	(Disabled)	—	—
0FE8 _H	SYSC	System configuration register	R/W	11000011 _B
0FE9 _H	CMCR	Clock monitoring control register	R/W	XX000000 _B
0FEA _H	CMDR	Clock monitoring data register	R	00000000 _B
0FEB _H	WDTH	Watchdog timer selection ID register (upper)	R	XXXXXXXX _B
0FEC _H	WDTL	Watchdog timer selection ID register (lower)	R	XXXXXXXX _B

(Continued)

(Continued)

Address	Register abbreviation	Register name	R/W	Initial value
0FED _H	—	(Disabled)	—	—
0FEE _H	ILSR	Input level select register	R/W	00000000 _B
0FEF _H	WICR	Interrupt pin control register	R/W	01000000 _B
0FF0 _H to 0FFF _H	—	(Disabled)	—	—

R/W access symbols

R/W : Readable / Writable

R : Read only

Initial value symbols

0 : The initial value of this bit is “0”.

1 : The initial value of this bit is “1”.

X : The initial value of this bit is indeterminate.

Note: Do not write to an address that is “(Disabled)”. If a “(Disabled)” address is read, an indeterminate value is returned.

16. Interrupt Source Table

Interrupt source	Interrupt request number	Vector table address		Bit name of interrupt level setting register	Priority order of interrupt sources of the same level (occurring simultaneously)
		Upper	Lower		
External interrupt ch. 0	IRQ00	FFFA _H	FFFB _H	L00 [1:0]	High  ↓ Low
External interrupt ch. 4					
External interrupt ch. 1	IRQ01	FFF8 _H	FFF9 _H	L01 [1:0]	
External interrupt ch. 5					
External interrupt ch. 2	IRQ02	FFF6 _H	FFF7 _H	L02 [1:0]	
External interrupt ch. 6					
External interrupt ch. 3	IRQ03	FFF4 _H	FFF5 _H	L03 [1:0]	
External interrupt ch. 7					
UART/SIO ch. 0	IRQ04	FFF2 _H	FFF3 _H	L04 [1:0]	
8/16-bit composite timer ch. 0 (lower)	IRQ05	FFF0 _H	FFF1 _H	L05 [1:0]	
8/16-bit composite timer ch. 0 (upper)	IRQ06	FFEE _H	FFEF _H	L06 [1:0]	
UART/SIO ch. 2	IRQ07	FFEC _H	FFED _H	L07 [1:0]	
LCD controller	IRQ08	FFEA _H	FFEB _H	L08 [1:0]	
8/16-bit PPG ch. 1 (lower)	IRQ09	FFE8 _H	FFE9 _H	L09 [1:0]	
UART/SIO ch. 1					
8/16-bit PPG ch. 1 (upper)	IRQ10	FFE6 _H	FFE7 _H	L10 [1:0]	
16-bit reload timer ch. 0	IRQ11	FFE4 _H	FFE5 _H	L11 [1:0]	
8/16-bit PPG ch. 0 (upper)	IRQ12	FFE2 _H	FFE3 _H	L12 [1:0]	
8/16-bit PPG ch. 0 (lower)	IRQ13	FFE0 _H	FFE1 _H	L13 [1:0]	
8/16-bit composite timer ch. 1 (upper)	IRQ14	FFDE _H	FFDF _H	L14 [1:0]	
Voltage comparator	IRQ15	FFDC _H	FFDD _H	L15 [1:0]	
I ² C	IRQ16	FFDA _H	FFDB _H	L16 [1:0]	
—	IRQ17	FFD8 _H	FFD9 _H	L17 [1:0]	
8/10-bit A/D converter	IRQ18	FFD6 _H	FFD7 _H	L18 [1:0]	
Time-base timer	IRQ19	FFD4 _H	FFD5 _H	L19 [1:0]	
Watch prescaler	IRQ20	FFD2 _H	FFD3 _H	L20 [1:0]	
Watch counter					
—	IRQ21	FFD0 _H	FFD1 _H	L21 [1:0]	
8/16-bit composite timer ch. 1 (lower)	IRQ22	FFCE _H	FFCF _H	L22 [1:0]	
Flash memory	IRQ23	FFCC _H	FFCD _H	L23 [1:0]	

17. Electrical Characteristics

17.1 Absolute Maximum Ratings

Parameter	Symbol	Rating		Unit	Remarks
		Min	Max		
Power supply voltage* ¹	V_{CC}	$V_{SS} - 0.3$	$V_{SS} + 6$	V	
Input voltage* ¹	V_I	$V_{SS} - 0.3$	$V_{SS} + 6$	V	*2
Output voltage* ¹	V_O	$V_{SS} - 0.3$	$V_{SS} + 6$	V	*2
Maximum clamp current	I_{CLAMP}	-2	+2	mA	Applicable to specific pins* ³
Total maximum clamp current	$\Sigma I_{CLAMP} $	—	20	mA	Applicable to specific pins* ³
“L” level maximum output current	I_{CL}	—	15	mA	
“L” level average current	I_{CLAV}	—	4	mA	Average output current = operating current × operating ratio (1 pin)
“L” level total maximum output current	ΣI_{OL}	—	100	mA	
“L” level total average output current	ΣI_{OLAV}	—	50	mA	Total average output current = operating current × operating ratio (Total number of pins)
“H” level maximum output current	I_{CH}	—	-15	mA	
“H” level average current	I_{CHAV}	—	-4	mA	Average output current = operating current × operating ratio (1 pin)
“H” level total maximum output current	ΣI_{OH}	—	-100	mA	
“H” level total average output current	ΣI_{OHAV}	—	-50	mA	Total average output current = operating current × operating ratio (Total number of pins)
Power consumption	P_d	—	320	mW	
Operating temperature	T_A	-40	+85	°C	
Storage temperature	T_{stg}	-55	+150	°C	

*1: These parameters are based on the condition that $V_{SS} = 0.0$ V.

*2: V_I and V_O must not exceed $V_{CC} + 0.3$ V. V_I must not exceed the rated voltage. However, if the maximum current to/from an input is limited by means of an external component, the I_{CLAMP} rating is used instead of the V_I rating.

(Continued)

(Continued)

*3: Applicable to the following pins: P00 to P07, P10, P11, P13 to P16, P20 to P22, P40 to P43, P50 to P53, P60 to P67, P90 to P94, PA0 to PA7, PB0 to PB4, PC0 to PC7, PE0 to PE7, PF0, PF1, PG1 and PG2 (P40 to P43, P50 to P53, P94, PB2 to PB4 and PC4 to PC7 are only available on the MB95410H Series.)

- Use under recommended operating conditions.
- Use with DC voltage (current).
- The HV (High Voltage) signal is an input signal exceeding the V_{CC} voltage. Always connect a limiting resistor between the HV (High Voltage) signal and the microcontroller before applying the HV (High Voltage) signal.
- The value of the limiting resistance should be set so that when the HV (High Voltage) signal is applied the input current to the microcontroller pin does not exceed rated values, either instantaneously or for prolonged periods.
- When the microcontroller drive current is low, such as in low power consumption modes, the HV (High Voltage) input potential may pass through the protective diode to increase the potential of the V_{CC} pin, and thus affects other devices.
- If the HV (High Voltage) signal is input when the microcontroller power supply is off (not fixed at 0 V), since power is supplied from the pins, incomplete operations may be executed.
- If the HV (High Voltage) input is input after power-on, since power is supplied from the pins, the voltage of power supply may not be sufficient to enable a power-on reset.
- Do not leave the HV (High Voltage) input pin unconnected.
- Example of a recommended circuit

Input/Output equivalent circuit

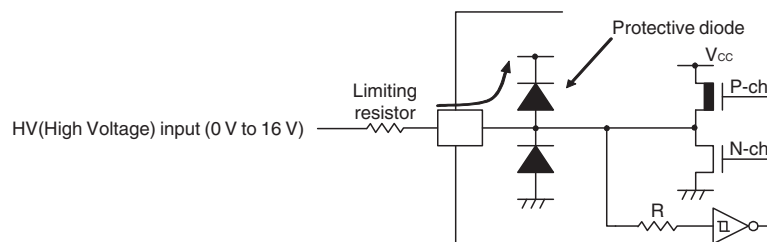

WARNING: Semiconductor devices can be permanently damaged by application of stress (voltage, current, temperature, etc.) in excess of absolute maximum ratings. Do not exceed these ratings.

17.2 Recommended Operating Conditions

 (V_{SS} = 0.0 V)

Parameter	Symbol	Value		Unit	Remarks	
		Min	Max			
Power supply voltage	V _{CC} , AV _{CC}	2.4*1*2	5.5*1	V	In normal operation	Other than on-chip debug mode
		2.3	5.5		Hold condition in stop mode	
		2.9	5.5		In normal operation	On-chip debug mode
		2.3	5.5		Hold condition in stop mode	
Smoothing capacitor	C _S	0.022	1	μF	*3	
Operating temperature	T _A	-40	+85	°C	Other than on-chip debug mode	
		+5	+35		On-chip debug mode	

*1: The value varies depending on the operating frequency, the machine clock and the analog guaranteed range.

*2: The value is initially 2.88 V when the low-voltage detection reset is used.

*3: Use a ceramic capacitor or a capacitor with equivalent frequency characteristics. The bypass capacitor for the V_{CC} pin must have a capacitance larger than C_S. For the connection to a smoothing capacitor C_S, see the diagram below. To prevent the device from unintentionally entering an unknown mode due to noise, minimize the distance between the C pin and C_S and the distance between C_S and the V_{SS} pin when designing the layout of a printed circuit board.

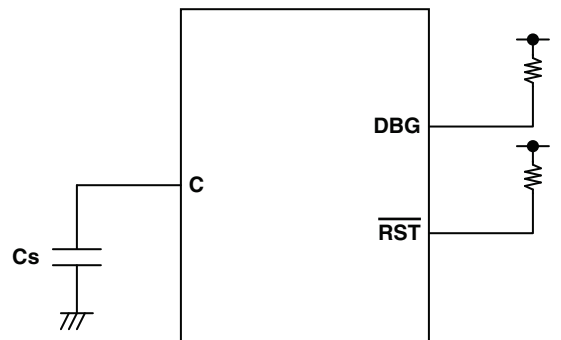
DBG / $\overline{\text{RST}}$ / C pins connection diagram

*: Since the DBG pin becomes a communication pin in on-chip debug mode, set a pull-up resistor value suiting the input/output specifications of P12/DBG.

WARNING: The recommended operating conditions are required in order to ensure the normal operation of the semiconductor device. All of the device's electrical characteristics are warranted when the device is operated within these ranges.

Always use semiconductor devices within their recommended operating condition ranges.

Operation outside these ranges may adversely affect reliability and could result in device failure.

No warranty is made with respect to uses, operating conditions, or combinations not represented on the data sheet. Users considering application outside the listed conditions are advised to contact their representatives beforehand.

17.3 DC Characteristics
 $(V_{CC} = 5.0\text{ V} \pm 10\%, V_{SS} = 0.0\text{ V}, T_A = -40^\circ\text{C to } +85^\circ\text{C})$

Parameter	Symbol	Pin name	Condition	Value			Unit	Remarks
				Min	Typ	Max		
"H" level input voltage	V_{IHI}	P01, P04, P10, P22, P23	*1	$0.7 V_{CC}$	—	$V_{CC} + 0.3$	V	When CMOS input level (hysteresis input) is selected
	V_{IHS}	P00 to P07, P10 to P17, P20 to P23, P40 to P43 ^{*2} , P50 to P53 ^{*2} , P60 to P67, P90 to P93, P94 ^{*2} , PA0 to PA7, PB0, PB1, PB2 to PB4 ^{*2} , PC0 to PC3, PC4 to PC7 ^{*2} , PE0 to PE7, PF0, PF1, PG1, PG2	*1	$0.8 V_{CC}$	—	$V_{CC} + 0.3$	V	Hysteresis input
	V_{IHM}	PF2	—	$0.7 V_{CC}$	—	$V_{CC} + 0.3$	V	Hysteresis input
"L" level input voltage	V_{IL}	P01, P04, P10, P22, P23	*1	$V_{SS} - 0.3$	—	$0.3 V_{CC}$	V	When CMOS input level (hysteresis input) is selected
	V_{ILS}	P00 to P07, P10 to P17, P20 to P23, P40 to P43 ^{*2} , P50 to P53 ^{*2} , P60 to P67, P90 to P93, P94 ^{*2} , PA0 to PA7, PB0, PB1, PB2 to PB4 ^{*2} , PC0 to PC3, PC4 to PC7 ^{*2} , PE0 to PE7, PF0, PF1, PG1, PG2	*1	$V_{SS} - 0.3$	—	$0.2 V_{CC}$	V	Hysteresis input
	V_{ILM}	PF2	—	$V_{SS} - 0.3$	—	$0.3 V_{CC}$	V	Hysteresis input
Open-drain output application voltage	V_D	P12, P22, P23, PF2	—	$V_{SS} - 0.3$	—	$V_{SS} + 5.5$	V	
"H" level output voltage	V_{OH1}	Output pins other than P12, P22, P23, PF2	$I_{OH} = -4\text{ mA}$	$V_{CC} - 0.5$	—	—	V	

(Continued)

$(V_{CC} = 5.0\text{ V} \pm 10\%, V_{SS} = 0.0\text{ V}, T_A = -40^\circ\text{C to } +85^\circ\text{C})$

Parameter	Symbol	Pin name	Condition	Value			Unit	Remarks
				Min	Typ ^{*4}	Max		
"L" level output voltage	V_{OL1}	All output pins	$I_{OL} = 4\text{ mA}$	—	—	0.4	V	
Input leak current (Hi-Z output leak current)	I_{LI}	All input pins	$0.0\text{ V} < V_I < V_{CC}$	-5	—	+5	μA	When pull-up resistance is disabled
Pull-up resistance	R_{PULL}	P10, P11, P13, P14, P17, P20, P21, P50 to P53 ^{*2} , PG1, PG2	$V_I = 0\text{ V}$	25	50	100	$\text{k}\Omega$	When pull-up resistance is enabled
Input capacitance	C_{IN}	Other than V_{CC} and V_{SS}	$f = 1\text{ MHz}$	—	5	15	pF	
Power supply current ^{*3}	I_{CC}	V_{CC} (External clock operation)	$V_{CC} = 5.5\text{ V}$ $F_{CH} = 32\text{ MHz}$ $F_{MP} = 16\text{ MHz}$ Main clock mode (divided by 2)	—	14.1	17	mA	Except during Flash memory programming and erasing
				—	20	39.5	mA	During Flash memory programming and erasing
	I_{CCS}		$V_{CC} = 5.5\text{ V}$ $F_{CH} = 32\text{ MHz}$ $F_{MP} = 16\text{ MHz}$ Main sleep mode (divided by 2)	—	6.6	9	mA	
	I_{CCL}		$V_{CC} = 5.5\text{ V}$ $F_{CL} = 32\text{ kHz}$ $F_{MPL} = 16\text{ kHz}$ Subclock mode (divided by 2) $T_A = +25^\circ\text{C}$	—	60	153	μA	
	I_{CCLS}		$V_{CC} = 5.5\text{ V}$ $F_{CL} = 32\text{ kHz}$ $F_{MPL} = 16\text{ kHz}$ Subsleep mode (divided by 2) $T_A = +25^\circ\text{C}$	—	9	84	μA	
I_{CCT}	$V_{CC} = 5.5\text{ V}$ $F_{CL} = 32\text{ kHz}$ Watch mode Main stop mode $T_A = +25^\circ\text{C}$	—	4.3	30	μA			

(Continued)

$(V_{CC} = 5.0\text{ V} \pm 10\%, V_{SS} = 0.0\text{ V}, T_A = -40^\circ\text{C to } +85^\circ\text{C})$

Parameter	Symbol	Pin name	Condition	Value			Unit	Remarks
				Min	Typ* ⁴	Max		
Power supply current* ³	I _{CCMPLL}	V _{CC} (External clock operation)	V _{CC} = 5.5 V F _{CH} = 4 MHz F _{MP} = 10 MHz Main PLL mode (multiplied by 2.5) T _A = +25°C	—	9.7	12.5	mA	
			V _{CC} = 5.5 V F _{CH} = 6.44 MHz F _{MP} = 16 MHz Main PLL mode (multiplied by 2.5) T _A = +25°C	—	13.9	20	mA	
	I _{CCMCR}	V _{CC}	V _{CC} = 5.5 V F _{CRH} = 12.5 MHz F _{MP} = 12.5 MHz Main CR clock mode	—	11	13.2	mA	
	I _{CCSCR}		V _{CC} = 5.5 V Sub-CR clock mode (multiplied by 2.5) T _A = +25°C	—	112	410	μA	
	I _{CCTS}	V _{CC} (External clock operation)	V _{CC} = 5.5 V F _{CH} = 32 MHz Time-base timer mode T _A = +25°C	—	1	3	mA	
	I _{CCH}		V _{CC} = 5.5 V Substop mode T _A = +25°C	—	3.1	22.5	μA	Main stop mode with one clock selected
	I _A	AV _{CC}	Current consumption for A/D conversion at 16 MHz	—	1.5	4.7	mA	
	I _{AH}		Current consumption for stopping A/D conversion at 16 MHz	—	1	5	μA	
	I _V		Current consumption of voltage comparator at 16 MHz	—	113	350	μA	

(Continued)

(Continued)

($V_{CC} = 5.0\text{ V} \pm 10\%$, $V_{SS} = 0.0\text{ V}$, $T_A = -40^\circ\text{C}$ to $+85^\circ\text{C}$)

Parameter	Symbol	Pin name	Condition	Value			Unit	Remarks
				Min	Typ*4	Max		
Power supply current*3	I_{LVD}	V_{CC}	Current consumption of the low-voltage detection circuit	—	31	54	μA	
	I_{CRH}		Current consumption of the main CR oscillator	—	0.5	0.6	mA	
	I_{CRL}		Current consumption of the sub-CR oscillator oscillating at 100 kHz	—	20	72	μA	
LCD internal division resistance	R_{LCD}	—	Between V_4 and V_{SS}	—	400	—	$\text{k}\Omega$	
				—	40	—	$\text{k}\Omega$	
COM0 to COM7 output impedance	R_{VCOM}	COM0 to COM7	V_1 to $V_4 = 4.1\text{ V}$	—	—	5	$\text{k}\Omega$	
SEG00 to SEG39 output impedance	R_{VSEG}	SEG00 to SEG39		—	—	7	$\text{k}\Omega$	
LCD leakage current	I_{LCDL}	V_0 to V_4 , COM0 to COM7, SEG00 to SEG39	—	-1	—	+1	μA	

*1: The input levels of P01, P04, P10, P22 and P23 can be switched between “CMOS input level” and “hysteresis input level”. The input level selection register (ILSR) is used to switch between the two input levels.

*2: P40 to P43, P50 to P53, P94, PB2 to PB4 and PC4 to PC7 are only available on the MB95410H Series.

*3: • The power supply current is determined by the external clock. When the low-voltage detection option is selected, the power-supply current will be the sum of adding the current consumption of the low-voltage detection circuit (I_{LVD}) to one of the value from I_{CC} to I_{CCH} . In addition, when both the low-voltage detection option and the CR oscillator are selected, the power supply current will be the sum of adding up the current consumption of the low-voltage detection circuit, the current consumption of the CR oscillators (I_{CRH} , I_{CRL}) and a specified value. In on-chip debug mode, the CR oscillator (I_{CRH}) and the low-voltage detection circuit are always enabled, and current consumption therefore increases accordingly.

• See “17.4. AC Characteristics: 17.4.1. Clock Timing” for F_{CH} and F_{CL} .

• See “17.4. AC Characteristics: 17.4.2. Source Clock/Machine Clock” for F_{MP} and F_{MPL} .

*4: $V_{CC} = 5.0\text{ V}$, $T_A = +25^\circ\text{C}$

17.4 AC Characteristics
17.4.1 Clock Timing
 $(V_{CC} = 2.4\text{ V to } 5.5\text{ V}, V_{SS} = 0.0\text{ V}, T_A = -40^\circ\text{C to } +85^\circ\text{C})$

Parameter	Symbol	Pin name	Condition	Value			Unit	Remarks
				Min	Typ	Max		
Clock frequency	F_{CH}	X0, X1	—	1	—	16.25	MHz	When the main oscillation circuit is used
		X0	X1: open	1	—	12	MHz	When the main external clock is used
		X0, X1	*	1	—	32.5	MHz	Main PLL multiplied by 2
			—	3	—	8.13	MHz	Main PLL multiplied by 2.5
			—	3	—	6.5	MHz	Main PLL multiplied by 2.5
			—	3	—	4.06	MHz	Main PLL multiplied by 4
	F_{CRH}	—	—	12.25	12.5	12.75	MHz	Operating conditions: • The main CR clock is used. • $T_A = -10^\circ\text{C to } +85^\circ\text{C}$
				9.8	10	10.2	MHz	
				7.84	8	8.16	MHz	
				0.98	1	1.02	MHz	
		—	—	12.1875	12.5	12.8125	MHz	Operating conditions: • The main CR clock is used. • $T_A = -40^\circ\text{C to } -10^\circ\text{C}$
				9.75	10	10.25	MHz	
				7.8	8	8.2	MHz	
				0.975	1	1.025	MHz	
F_{CL}	X0A, X1A	—	—	32.768	—	kHz	When the sub-oscillation circuit is used	
			—	32.768	—	kHz	When the sub-external clock is used	
F_{CRL}	—	—	—	50	100	200	kHz	When the sub-CR clock is used
Clock cycle time	t_{HCYL}	X0, X1	—	61.5	—	1000	ns	When the main oscillation circuit is used
		X0	X1: open	83.4	—	1000	ns	When the external clock is used
		X0, X1	*	30.8	—	1000	ns	
	t_{LCYL}	X0A, X1A	—	—	30.5	—	μs	When the subclock is used
Input clock pulse width	t_{WH1}	X0	X1: open	33.4	—	—	ns	When the external clock is used, the duty ratio should range between 40% and 60%.
	t_{WL1}	X0, X1	*	12.4	—	—	ns	
	t_{WH2} t_{WL2}	X0A	—	—	15.2	—	μs	
Input clock rise time and fall time	t_{CR}	X0	X1: open	—	—	5	ns	When the external clock is used
	t_{CF}	X0, X1	*	—	—	5	ns	
CR oscillation start time	t_{CRHWK}	—	—	—	—	80	μs	When the main CR clock is used
	t_{CRLWK}	—	—	—	—	10	μs	When the sub-CR clock is used

*: The external clock signal is input to X0 and the inverted external clock signal to X1.

Input waveform generated when an external clock (main clock) is used

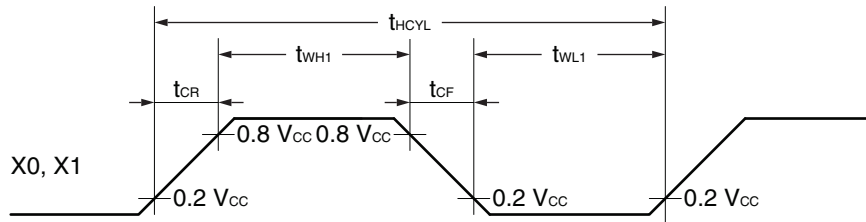
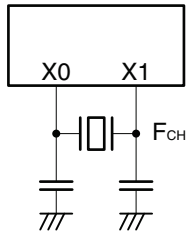
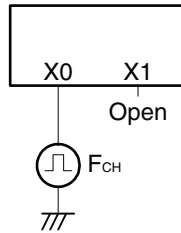

Figure of main clock input port external connection

When a crystal oscillator or a ceramic oscillator is used



When the external clock is used (X1 is open)



When the external clock is used (X0 is open)

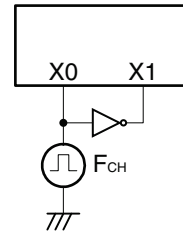

Input waveform generated when an external clock (subclock) is used

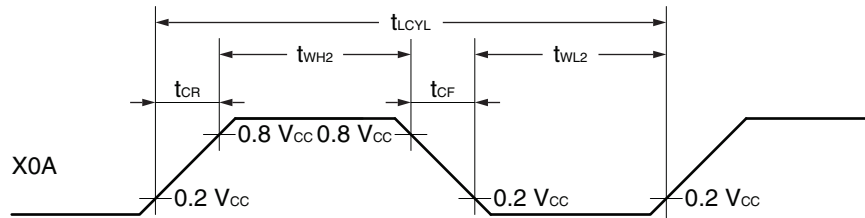
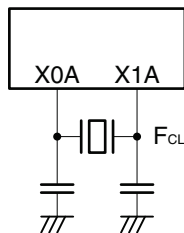
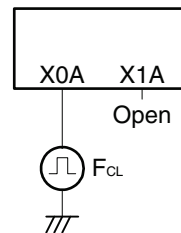

Figure of subclock input port external connection

When a crystal oscillator or a ceramic oscillator is used



When the external clock is used



17.4.2 Source Clock/Machine Clock
 $(V_{CC} = 5.0\text{ V} \pm 10\%, V_{SS} = 0.0\text{ V}, T_A = -40^\circ\text{C to } +85^\circ\text{C})$

Parameter	Symbol	Pin name	Value			Unit	Remarks
			Min	Typ	Max		
Source clock cycle time* ¹	t_{SCLK}	—	61.5	—	2000	ns	When the main oscillation clock is used Min: $F_{CH} = 32.5\text{ MHz}$, divided by 2 Max: $F_{CH} = 1\text{ MHz}$, divided by 2
			61.5	—	2000	ns	When the main oscillation clock is used Min: $F_{CH} = 8.125\text{ MHz}$, multiplied by the PLL multiplier of 2 Max: $F_{CH} = 1\text{ MHz}$, divided by 2
			80	—	1000	ns	When the main CR clock is used Min: $F_{CRH} = 12.5\text{ MHz}$ Max: $F_{CRH} = 1\text{ MHz}$
			—	61	—	μs	When the sub-oscillation clock is used $F_{CL} = 32.768\text{ kHz}$, divided by 2
			—	20	—	μs	When the sub-CR clock is used $F_{CRL} = 100\text{ kHz}$, divided by 2
Source clock frequency	F_{SP}	—	0.50	—	16.25	MHz	When the main oscillation clock is used
			1	—	12.5	MHz	When the main CR clock is used
	—		16.384	—	kHz	When the sub-oscillation clock is used	
	F_{SPL}		—	50	—	kHz	When the sub-CR clock is used $F_{CRL} = 100\text{ kHz}$, divided by 2
Machine clock cycle time* ² (minimum instruction execution time)	t_{MCLK}	—	61.5	—	32000	ns	When the main oscillation clock is used Min: $F_{SP} = 16.25\text{ MHz}$, no division Max: $F_{SP} = 0.5\text{ MHz}$, divided by 16
			80	—	16000	ns	When the main CR clock is used Min: $F_{SP} = 12.5\text{ MHz}$ Max: $F_{SP} = 1\text{ MHz}$, divided by 16
			61	—	976.5	μs	When the sub-oscillation clock is used Min: $F_{SPL} = 16.384\text{ kHz}$, no division Max: $F_{SPL} = 16.384\text{ kHz}$, divided by 16
			20	—	320	μs	When the sub-CR clock is used Min: $F_{SPL} = 50\text{ kHz}$, no division Max: $F_{SPL} = 50\text{ kHz}$, divided by 16
Machine clock frequency	F_{MP}	—	0.031	—	16.25	MHz	When the main oscillation clock is used
			0.0625	—	12.5	MHz	When the main CR clock is used
	F_{MPL}		1.024	—	16.384	kHz	When the sub-oscillation clock is used
	F_{MPL}		3.125	—	50	kHz	When the sub-CR clock is used $F_{CRL} = 100\text{ kHz}$

*1: This is the clock before it is divided according to the division ratio set by the machine clock divide ratio select bits (SYCC:DIV1, DIV0). This source clock is divided to become a machine clock according to the division ratio set by the machine clock divide ratio select bits (SYCC:DIV1, DIV0). In addition, a source clock can be selected from the following.

- Main clock divided by 2
- PLL multiplication of main clock (select from 2, 2.5, 4 multiplication)
- Main CR clock divided by 2
- Subclock divided by 2
- Sub-CR clock divided by 2

(Continued)

(Continued)

*2: This is the operating clock of the microcontroller. A machine clock can be selected from the following.

- Source clock (no division)
- Source clock divided by 4
- Source clock divided by 8
- Source clock divided by 16

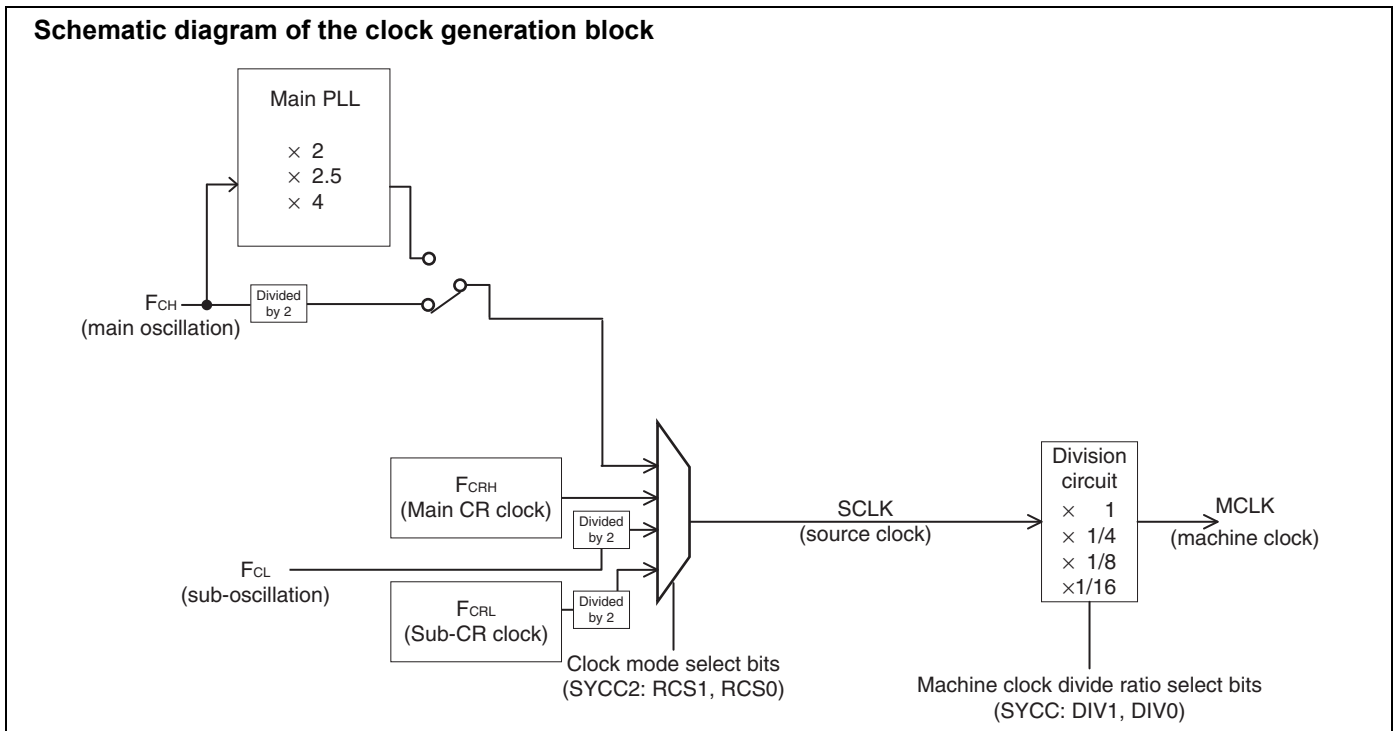

Operating voltage - Operating frequency (When $T_A = -40^\circ\text{C}$ to $+85^\circ\text{C}$)

Without the on-chip debug function

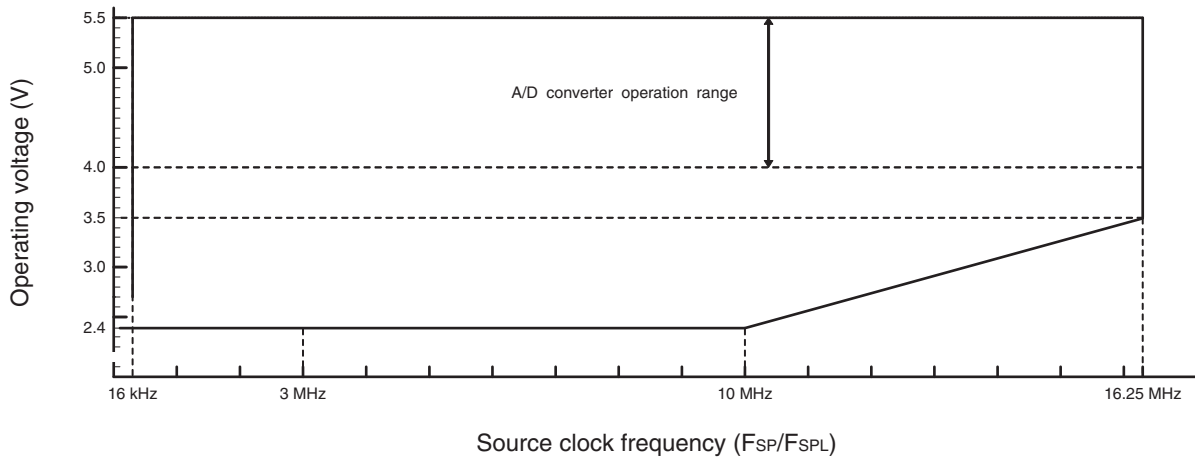

Operating voltage - Operating frequency (When $T_A = -40^\circ\text{C}$ to $+85^\circ\text{C}$)

With the on-chip debug function

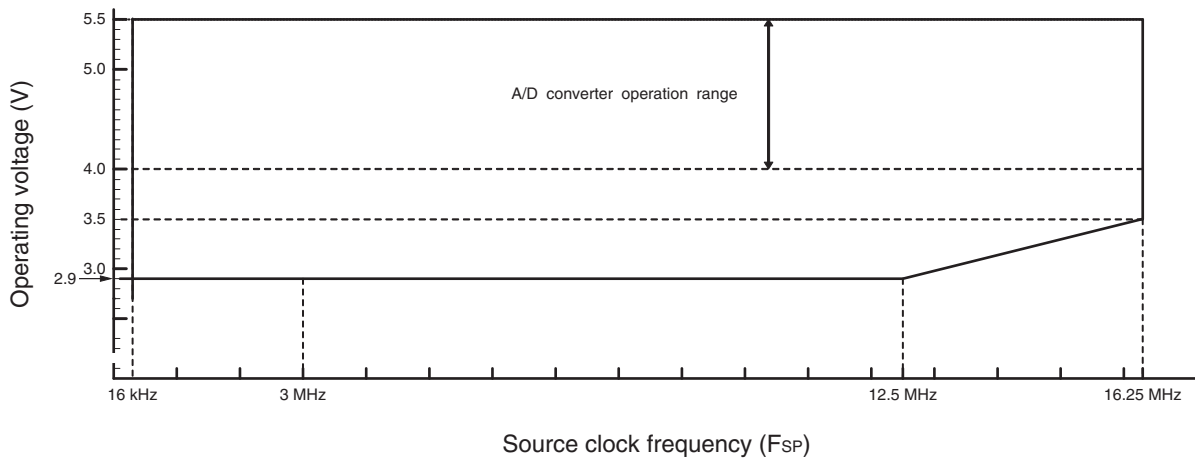

17.4.3 External Reset

($V_{CC} = 5.0\text{ V} \pm 10\%$, $V_{SS} = 0.0\text{ V}$, $T_A = -40^\circ\text{C}$ to $+85^\circ\text{C}$)

Parameter	Symbol	Value		Unit	Remarks
		Min	Max		
$\overline{\text{RST}}$ "L" level pulse width	t_{RSTL}	$2 t_{\text{MCLK}}^{*1}$	—	ns	In normal operation
		Oscillation time of the oscillator ^{*2} + 100	—	μs	In stop mode, subclock mode, subsleep mode, watch mode, and power-on
		100	—	μs	In time-base timer mode

*1: See "17.4.2. Source Clock/Machine Clock" for t_{MCLK} .

*2: The oscillation time of an oscillator is the time for it to reach 90% of its amplitude. The crystal oscillator has an oscillation time of between several ms and tens of ms. The ceramic oscillator has an oscillation time of between hundreds of μs and several ms. The external clock has an oscillation time of 0 ms. The CR oscillator clock has an oscillation time of between several μs and several ms.

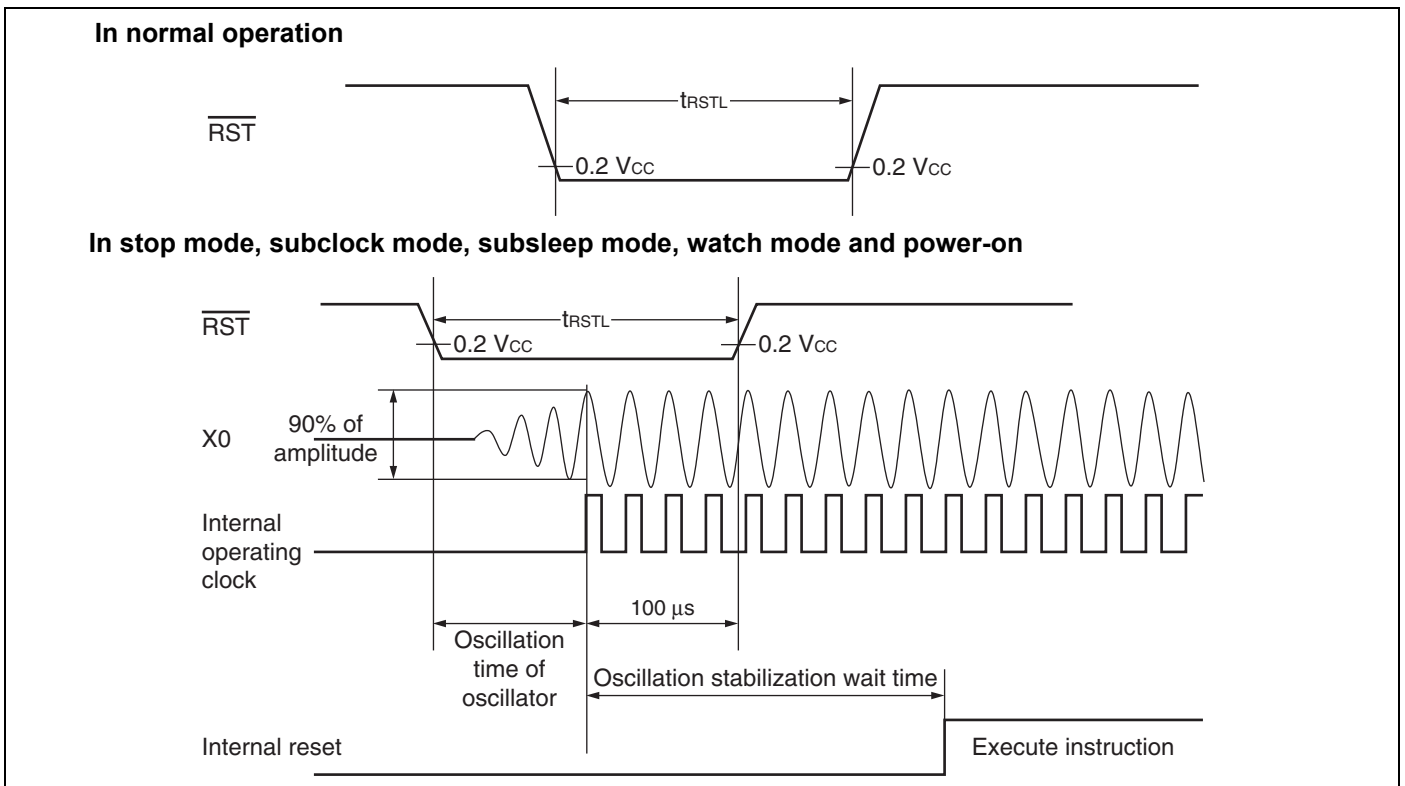

17.4.4 Power-on Reset
 $(V_{SS} = 0.0\text{ V}, T_A = -40^\circ\text{C to } +85^\circ\text{C})$

Parameter	Symbol	Condition	Value		Unit	Remarks
			Min	Max		
Power supply rising time	t_R	—	—	50	ms	
Power supply cutoff time	t_{OFF}	—	1	—	ms	Wait time until power-on

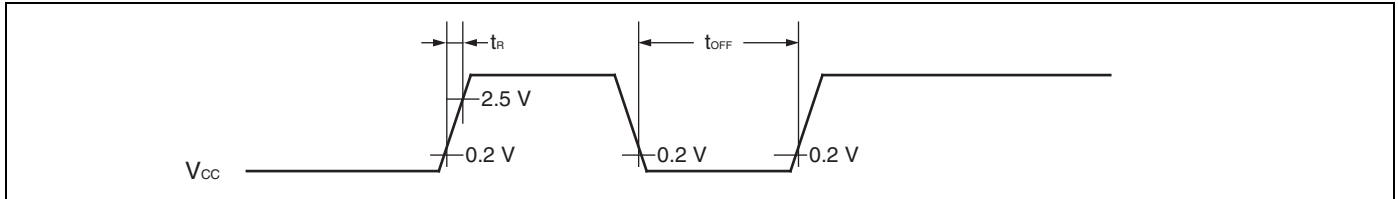

Note: A sudden change of power supply voltage may activate the power-on reset function. When changing the power supply voltage during the operation, set the slope of rising to a value below within 30 mV/ms as shown below.

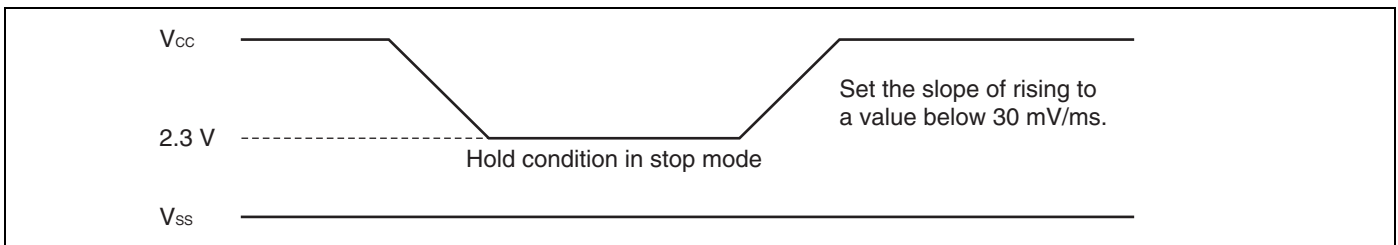
17.4.5 Peripheral Input Timing
 $(V_{CC} = 5.0\text{ V} \pm 10\%, V_{SS} = 0.0\text{ V}, T_A = -40^\circ\text{C to } +85^\circ\text{C})$

Parameter	Symbol	Pin name	Value		Unit
			Min	Max	
Peripheral input "H" pulse width	t_{LH}	INT00 to INT07, EC0, EC1, ADTG	$2 t_{MCLK}^*$	—	ns
Peripheral input "L" pulse width	t_{HL}		$2 t_{MCLK}^*$	—	ns

*: See "17.4.2. Source Clock/Machine Clock" for t_{MCLK} .

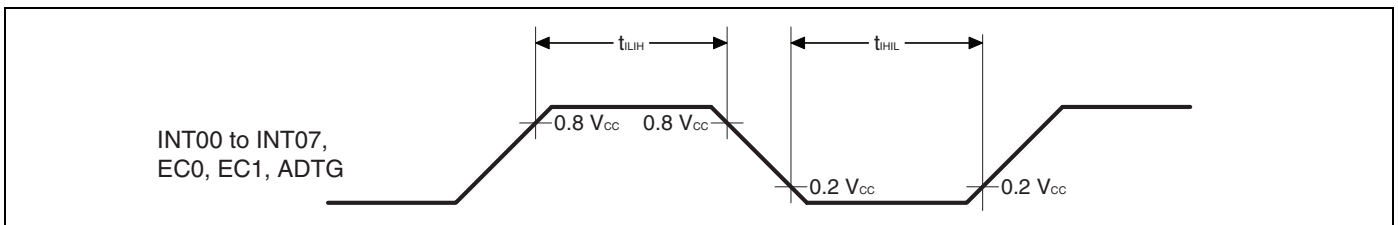

17.4.6 UART/SIO, Serial I/O Timing
 $(V_{CC} = 5.0\text{ V} \pm 10\%, AV_{SS} = V_{SS} = 0.0\text{ V}, T_A = -40^\circ\text{C to } +85^\circ\text{C})$

Parameter	Symbol	Pin name	Condition	Value		Unit
				Min	Max	
Serial clock cycle time	t_{SCYC}	UCK0, UCK1, UCK2	Internal clock operation output pin: $C_L = 80\text{ pF} + 1\text{ TTL}$	$4 t_{MCLK}^*$	—	ns
UCK ↓→ UO time	t_{SLOVI}	UCK0, UCK1, UCK2, UO0, UO1, UO2		-190	+190	ns
Valid UI → UCK ↑	t_{IVSHI}	UCK0, UCK1, UCK2, UI0, UI1, UI2		$2 t_{MCLK}^*$	—	ns
UCK ↑→ valid UI hold time	t_{SHIXI}	UCK0, UCK1, UCK2, UI0, UI1, UI2		$2 t_{MCLK}^*$	—	ns
Serial clock "H" pulse width	t_{SHSL}	UCK0, UCK1, UCK2	External clock operation output pin: $C_L = 80\text{ pF} + 1\text{ TTL}$	$4 t_{MCLK}^*$	—	ns
Serial clock "L" pulse width	t_{SLSH}	UCK0, UCK1, UCK2		$4 t_{MCLK}^*$	—	ns
UCK ↓→ UO time	t_{SLOVE}	UCK0, UCK1, UCK2, UO0, UO1, UO2		—	190	ns
Valid UI → UCK ↑	t_{IVSHE}	UCK0, UCK1, UCK2, UI0, UI1, UI2		$2 t_{MCLK}^*$	—	ns
UCK ↑→ valid UI hold time	t_{SHIXE}	UCK0, UCK1, UCK2, UI0, UI1, UI2		$2 t_{MCLK}^*$	—	ns

*: See "17.4.2. Source Clock/Machine Clock" for t_{MCLK} .

Internal shift clock mode

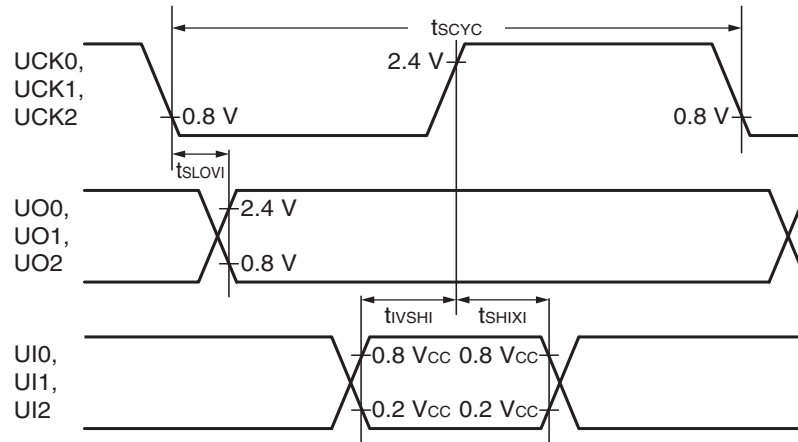

External shift clock mode

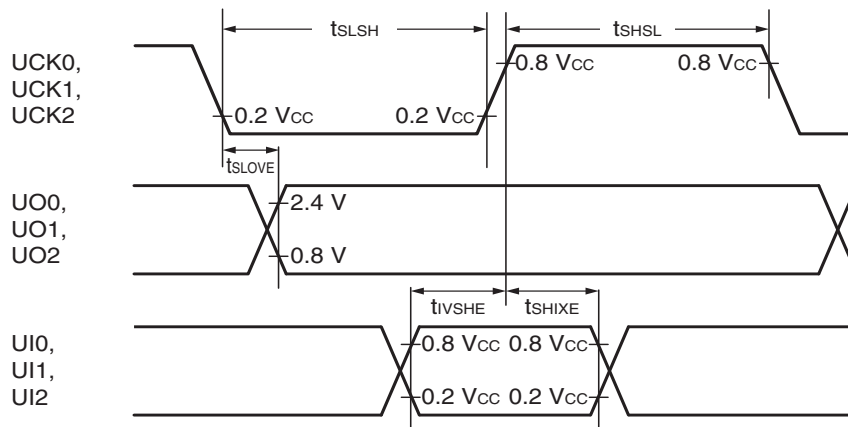

17.4.7 Low-voltage Detection

 ($V_{SS} = 0.0\text{ V}$, $T_A = -40^\circ\text{C}$ to $+85^\circ\text{C}$)

Parameter	Symbol	Value			Unit	Remarks
		Min	Typ	Max		
Release voltage	V_{DL+}	2.52	2.7	2.88	V	At power supply rise
Detection voltage	V_{DL-}	2.42	2.6	2.78	V	At power supply fall
Hysteresis width	V_{HYS}	70	100	—	mV	
Power supply start voltage	V_{off}	—	—	2.3	V	
Power supply end voltage	V_{on}	4.9	—	—	V	
Power supply voltage change time (at power supply rise)	t_r	3000	—	—	μs	Slope of power supply that the reset release signal generates within the rating (V_{DL+})
Power supply voltage change time (at power supply fall)	t_f	300	—	—	μs	Slope of power supply that the reset detection signal generates within the rating (V_{DL-})
Reset release delay time	t_{d1}	—	—	300	μs	
Reset detection delay time	t_{d2}	—	—	20	μs	

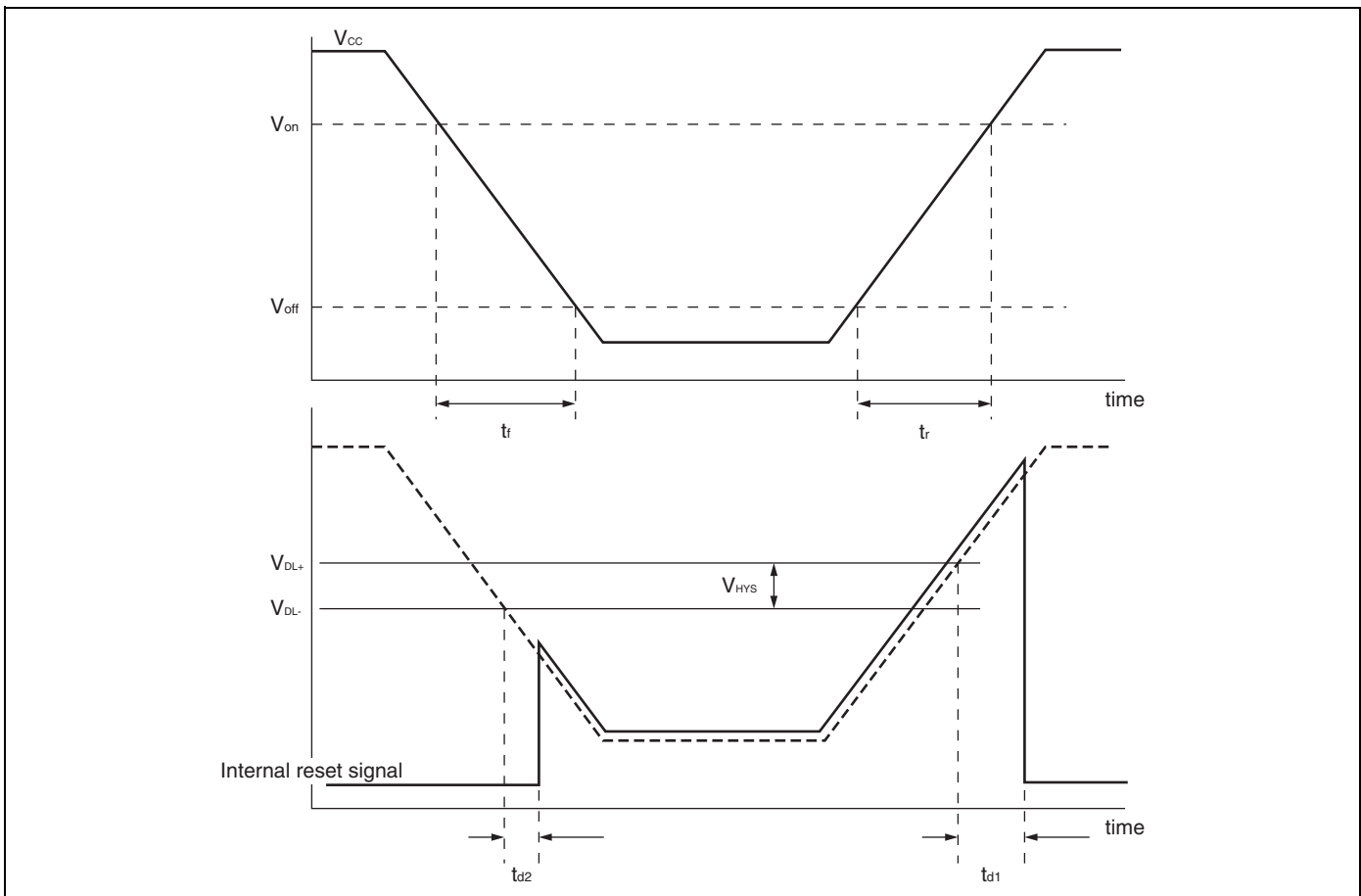

17.4.8 I²C Timing

 (V_{CC} = 5.0 V ±10%, AV_{SS} = V_{SS} = 0.0 V, T_A = -40°C to +85°C)

Parameter	Symbol	Pin name	Conditions	Value				Unit
				Standard-mode		Fast-mode		
				Min	Max	Min	Max	
SCL clock frequency	f _{SCL}	SCL	R = 1.7 kΩ, C = 50 pF*1	0	100	0	400	kHz
(Repeat) Start condition hold time SDA ↓ → SCL ↓	t _{HD;STA}	SCL, SDA		4.0	—	0.6	—	μs
SCL clock "L" width	t _{LOW}	SCL		4.7	—	1.3	—	μs
SCL clock "H" width	t _{HIGH}	SCL		4.0	—	0.6	—	μs
(Repeat) Start condition setup time SCL ↑ → SDA ↓	t _{SU;STA}	SCL, SDA		4.7	—	0.6	—	μs
Data hold time SCL ↓ → SDA ↓ ↑	t _{HD;DAT}	SCL, SDA		0	3.45*2	0	0.9*3	μs
Data setup time SDA ↓ ↑ → SCL ↑	t _{SU;DAT}	SCL, SDA		0.25	—	0.1	—	μs
Stop condition setup time SCL ↑ → SDA ↑	t _{SU;STO}	SCL, SDA		4.0	—	0.6	—	μs
Bus free time between stop condition and start condition	t _{BUF}	SCL, SDA	4.7	—	1.3	—	μs	

*1: R represents the pull-up resistor of the SCL and SDA lines, and C the load capacitor of the SCL and SDA lines.

*2: The maximum t_{HD;DAT} in the Standard-mode is applicable only when the time during which the device is holding the SCL signal at "L" (t_{LOW}) does not extend.

*3: A Fast-mode I²C-bus device can be used in a Standard-mode I²C-bus system, provided that the condition of t_{SU;DAT} ≥ 250 ns is fulfilled.

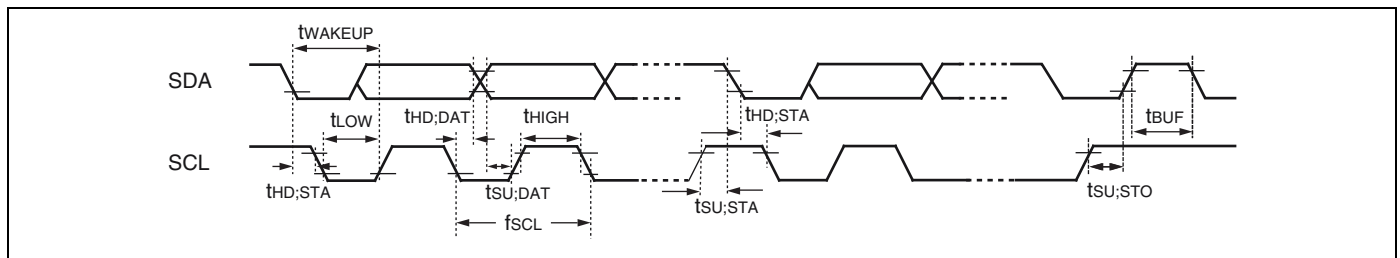

(Continued)

$(V_{CC} = 5.0\text{ V} \pm 10\%, AV_{SS} = V_{SS} = 0.0\text{ V}, T_A = -40^\circ\text{C to } +85^\circ\text{C})$

Parameter	Symbol	Pin name	Conditions	Value*2		Unit	Remarks
				Min	Max		
SCL clock "L" width	t_{LOW}	SCL	R = 1.7 k Ω , C = 50 pF*1	$(2 + nm / 2)t_{MCLK} - 20$	—	ns	Master mode
SCL clock "H" width	t_{HIGH}	SCL		$(nm / 2)t_{MCLK} - 20$	$(nm / 2)t_{MCLK} + 20$	ns	Master mode
Start condition hold time	$t_{HD;STA}$	SCL, SDA		$(-1 + nm / 2)t_{MCLK} - 20$	$(-1 + nm)t_{MCLK} + 20$	ns	Master mode Maximum value is applied when m, n = 1, 8. Otherwise, the minimum value is applied.
Stop condition setup time	$t_{SU;STO}$	SCL, SDA		$(1 + nm / 2)t_{MCLK} - 20$	$(1 + nm / 2)t_{MCLK} + 20$	ns	Master mode
Start condition setup time	$t_{SU;STA}$	SCL, SDA		$(1 + nm / 2)t_{MCLK} - 20$	$(1 + nm / 2)t_{MCLK} + 20$	ns	Master mode
Bus free time between stop condition and start condition	t_{BUF}	SCL, SDA		$(2nm + 4)t_{MCLK} - 20$	—	ns	
Data hold time	$t_{HD;DAT}$	SCL, SDA		$3 t_{MCLK} - 20$	—	ns	Master mode
Data setup time	$t_{SU;DAT}$	SCL, SDA		$(-2 + nm / 2)t_{MCLK} - 20$	$(-1 + nm / 2)t_{MCLK} + 20$	ns	Master mode When assuming that "L" of SCL is not extended, the minimum value is applied to first bit of continuous data. Otherwise, the maximum value is applied.
Setup time between clearing interrupt and SCL rising	$t_{SU;INT}$	SCL		$(nm / 2)t_{MCLK} - 20$	$(1 + nm / 2)t_{MCLK} + 20$	ns	Minimum value is applied to interrupt at 9th SCL \downarrow . Maximum value is applied to interrupt at 8th SCL \downarrow .
SCL clock "L" width	t_{LOW}	SCL		$4 t_{MCLK} - 20$	—	ns	At reception
SCL clock "H" width	t_{HIGH}	SCL		$4 t_{MCLK} - 20$	—	ns	At reception

(Continued)

(Continued)

 $(V_{CC} = 5.0\text{ V} \pm 10\%, AV_{SS} = V_{SS} = 0.0\text{ V}, T_A = -40^\circ\text{C to } +85^\circ\text{C})$

Parameter	Symbol	Pin name	Conditions	Value*2		Unit	Remarks
				Min	Max		
Start condition detection	$t_{HD;STA}$	SCL, SDA	R = 1.7 k Ω , C = 50 pF*1	$2 t_{MCLK} - 20$	—	ns	Not detected when 1 t_{MCLK} is used at reception
Stop condition detection	$t_{SU;STO}$	SCL, SDA		$2 t_{MCLK} - 20$	—	ns	Not detected when 1 t_{MCLK} is used at reception
Restart condition detection condition	$t_{SU;STA}$	SCL, SDA		$2 t_{MCLK} - 20$	—	ns	Not detected when 1 t_{MCLK} is used at reception
Bus free time	t_{BUF}	SCL, SDA		$2 t_{MCLK} - 20$	—	ns	At reception
Data hold time	$t_{HD;DAT}$	SCL, SDA		$2 t_{MCLK} - 20$	—	ns	At slave transmission mode
Data setup time	$t_{SU;DAT}$	SCL, SDA		$t_{LOW} - 3 t_{MCLK} - 20$	—	ns	At slave transmission mode
Data hold time	$t_{HD;DAT}$	SCL, SDA		0	—	ns	At reception
Data setup time	$t_{SU;DAT}$	SCL, SDA		$t_{MCLK} - 20$	—	ns	At reception
SDA \downarrow →SCL \uparrow (at wakeup function)	t_{WAKEUP}	SCL, SDA		Oscillation stabilization wait time $+ 2 t_{MCLK} - 20$	—	ns	

*1: R represents the pull-up resistor of the SCL and SDA lines, and C the load capacitor of the SCL and SDA lines.

*2: • See “17.4.2. Source Clock/Machine Clock” for t_{MCLK} .

- m represents the CS4 bit and CS3 bit (bit4 and bit3) in the I²C clock control register (ICCR0).
- n represents the CS2 bit to CS0 bit (bit2 to bit0) in the I²C clock control register (ICCR0).
- The actual timing of I²C is determined by the values of m and n set by the machine clock (t_{MCLK}) and the CS4 to CS0 bits in the ICCR0 register.
- Standard-mode:
 - m and n can be set to values in the following range: 0.9 MHz < t_{MCLK} (machine clock) < 16.25 MHz.
 - The usable frequencies of the machine clock are determined by the settings of m and n as shown below.
 - (m, n) = (1, 8) : 0.9 MHz < t_{MCLK} ≤ 1 MHz
 - (m, n) = (1, 22), (5, 4), (6, 4), (7, 4), (8, 4) : 0.9 MHz < t_{MCLK} ≤ 2 MHz
 - (m, n) = (1, 38), (5, 8), (6, 8), (7, 8), (8, 8) : 0.9 MHz < t_{MCLK} ≤ 4 MHz
 - (m, n) = (1, 98), (5, 22), (6, 22), (7, 22) : 0.9 MHz < t_{MCLK} ≤ 10 MHz
 - (m, n) = (8, 22) : 0.9 MHz < t_{MCLK} ≤ 16.25 MHz
- Fast-mode:
 - m and n can be set to values in the following range: 3.3 MHz < t_{MCLK} (machine clock) < 16.25 MHz.
 - The usable frequencies of the machine clock are determined by the settings of m and n as shown below.
 - (m, n) = (1, 8) : 3.3 MHz < t_{MCLK} ≤ 4 MHz
 - (m, n) = (1, 22), (5, 4) : 3.3 MHz < t_{MCLK} ≤ 8 MHz
 - (m, n) = (1, 38), (6, 4), (7, 4), (8, 4) : 3.3 MHz < t_{MCLK} ≤ 10 MHz
 - (m, n) = (5, 8) : 3.3 MHz < t_{MCLK} ≤ 16.25 MHz

17.4.9 Voltage Comparator Timing

 (AV_{CC} = 4.0 V to 5.5 V, AV_{SS} = 0.0 V, T_A = -40°C to +85°C)

Parameter	Pin name	Value			Unit	Remarks
		Min	Typ	Max		
Voltage range	CMPP, CMPN	0	—	AV _{CC} - 1.3	V	
Offset voltage	CMPP, CMPN	-10	—	+10	mV	
Delay time	CMPO	—	650	1210	ns	5 mV overdrive
		—	140	420	ns	50 mV overdrive
Power down delay	CMPO	—	—	1210	ns	Power down recovery PD: 1 → 0
		0	—	—	ns	Power down effective PD: 0 → 1 Output: "H" level
Power up stabilization time	CMPO	—	—	1210	ns	Output stabilization time at power up
Bandgap reference voltage	—	1.17	1.22	1.27	V	

17.5 A/D Converter
17.5.1 A/D Converter Electrical Characteristics
 $(AV_{CC} = V_{CC} = 4.0\text{ V to } 5.5\text{ V}, AV_{SS} = V_{SS} = 0.0\text{ V}, T_A = -40^\circ\text{C to } +85^\circ\text{C})$

Parameter	Symbol	Value			Unit	Remarks
		Min	Typ	Max		
Resolution	—	—	—	10	bit	
Total error		-3	—	+3	LSB	
Linearity error		-2.5	—	+2.5	LSB	
Differential linear error		-1.9	—	+1.9	LSB	
Zero transition voltage	V_{OT}	$AV_{SS} - 1.5\text{ LSB}$	$AV_{SS} + 0.5\text{ LSB}$	$AV_{SS} + 2.5\text{ LSB}$	V	
Full-scale transition voltage	V_{FST}	$AV_{CC} - 4.5\text{ LSB}$	$AV_{CC} - 2\text{ LSB}$	$AV_{CC} + 0.5\text{ LSB}$	V	
Compare time	—	0.9	—	16500	μs	$4.5\text{ V} \leq V_{CC} \leq 5.5\text{ V}$
		1.8	—	16500	μs	$4.0\text{ V} \leq V_{CC} < 4.5\text{ V}$
Sampling time	—	0.6	—	∞	μs	$4.5\text{ V} \leq V_{CC} \leq 5.5\text{ V}$, with external impedance < 5.4 k Ω
		1.2	—	∞	μs	$4.0\text{ V} \leq V_{CC} < 4.5\text{ V}$, with external impedance < 2.4 k Ω
Analog input current	I_{AIN}	-0.3	—	+0.3	μA	
Analog input voltage	V_{AIN}	AV_{SS}	—	AV_{CC}	V	

17.5.2 Notes on Using the A/D Converter

External impedance of analog input and its sampling time

The A/D converter has a sample and hold circuit. If the external impedance is too high to keep sufficient sampling time, the analog voltage charged to the capacitor of the internal sample and hold circuit is insufficient, adversely affecting A/D conversion precision. Therefore, to satisfy the A/D conversion precision standard, considering the relationship between the external impedance and minimum sampling time, either adjust the register value and operating frequency or decrease the external impedance so that the sampling time is longer than the minimum value. In addition, if sufficient sampling time cannot be secured, connect a capacitor of about 0.1 μF to the analog input pin.

Analog input equivalent circuit

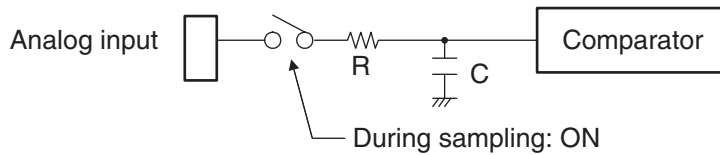

V _{CC}	R	C
4.5 V ≤ V _{CC} ≤ 5.5 V	1.95 kΩ (Max)	17 pF (Max)
4.0 V ≤ V _{CC} < 4.5 V	8.98 kΩ (Max)	17 pF (Max)

Note: The values are reference values.

Relationship between external impedance and minimum sampling time

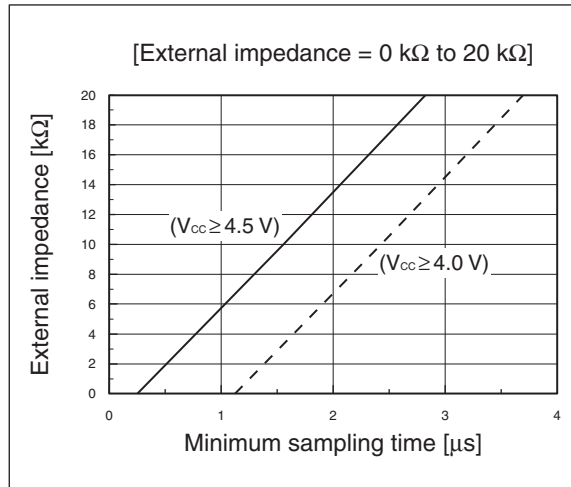
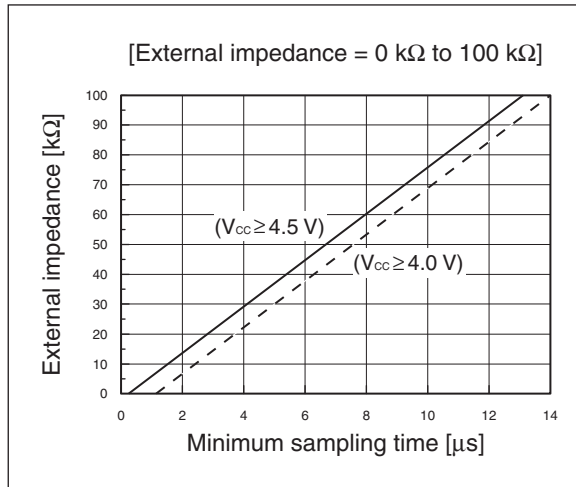

A/D conversion error

As $|V_{CC} - V_{SS}|$ decreases, the A/D conversion error increases proportionately.

17.5.3 Definitions of A/D Converter Terms

Resolution

It indicates the level of analog variation that can be distinguished by the A/D converter. When the number of bits is 10, analog voltage can be divided into $2^{10} = 1024$.

Linearity error (unit: LSB)

It indicates how much an actual conversion value deviates from the straight line connecting the zero transition point ("00 0000 0000" ← → "00 0000 0001") of a device to the full-scale transition point ("11 1111 1111" ← → "11 1111 1110") of the same device.

Differential linear error (unit: LSB)

It indicates how much the input voltage required to change the output code by 1 LSB deviates from an ideal value.

Total error (unit: LSB)

It indicates the difference between an actual value and a theoretical value. The error can be caused by a zero transition error, a full-scale transition errors, a linearity error, a quantum error, or noise.

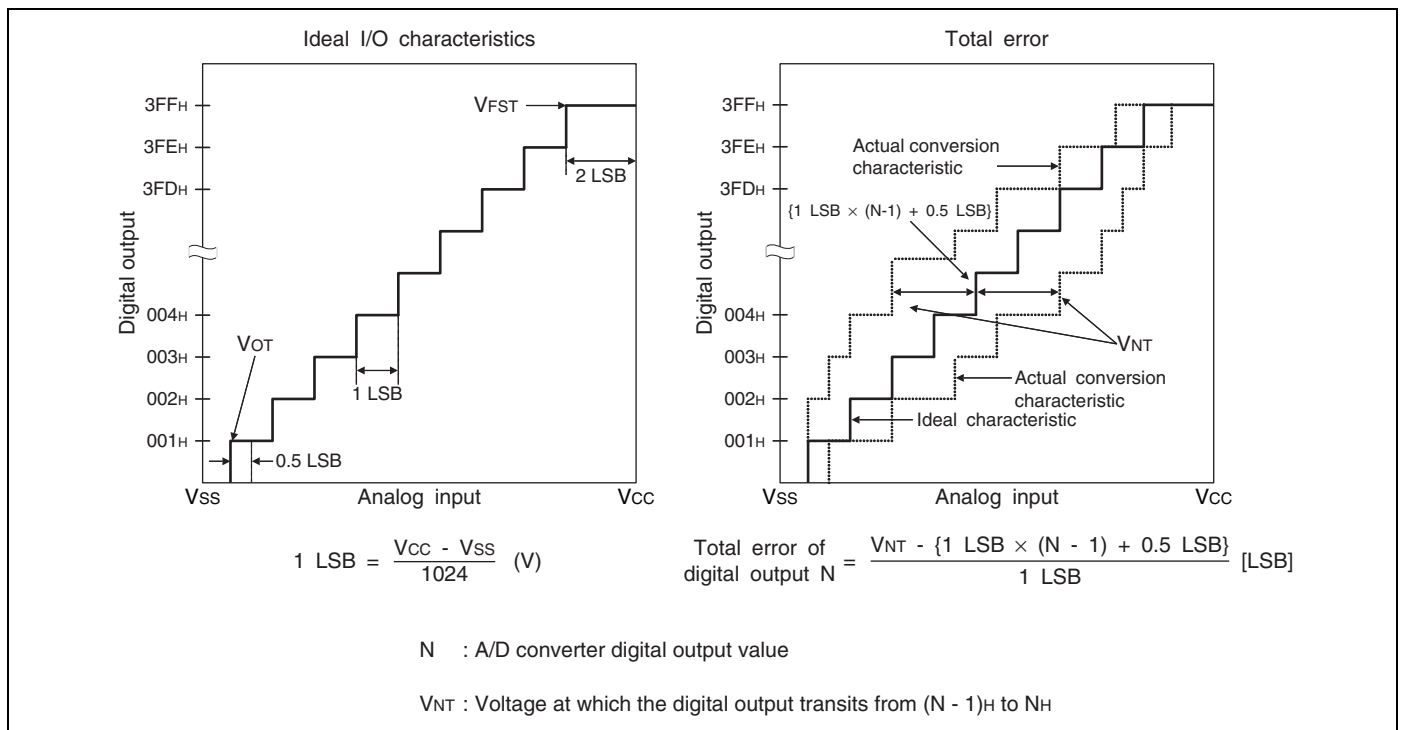

(Continued)

(Continued)

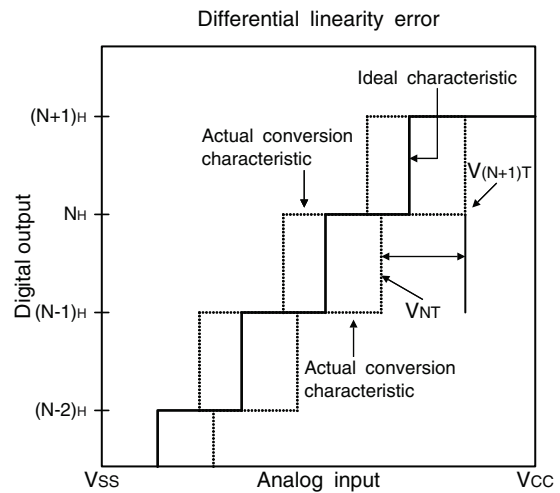
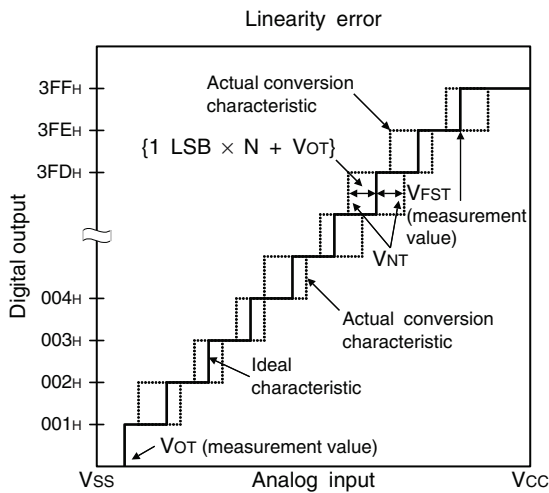
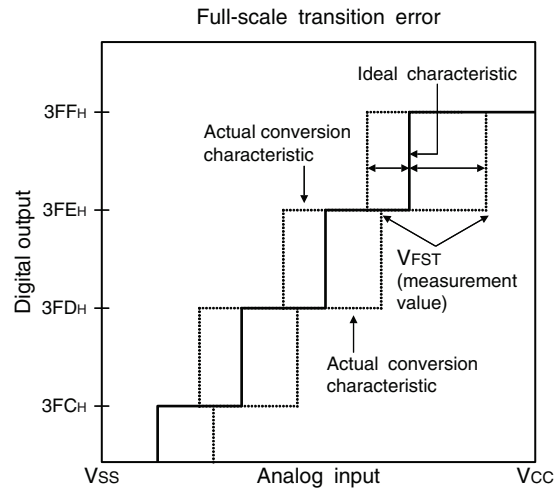
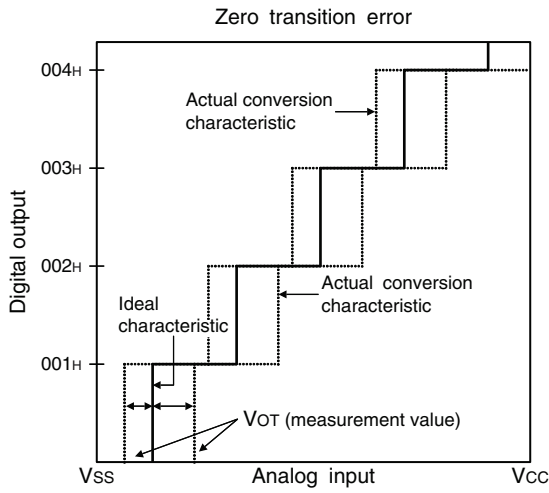

$$\text{Linearity error of digital output } N = \frac{V_{NT} - \{1 \text{ LSB} \times N + V_{OT}\}}{1 \text{ LSB}}$$

$$\text{Differential linear error of digital output } N = \frac{V_{(N+1)T} - V_{NT}}{1 \text{ LSB}} - 1$$

N : A/D converter digital output value

V_{NT} : Voltage at which the digital output transits from (N - 1)_H to N_H

V_{OT} (ideal value) = $V_{SS} + 0.5 \text{ LSB [V]}$

V_{FST} (ideal value) = $V_{CC} - 2 \text{ LSB [V]}$

17.6 Flash Memory Program/Erase Characteristics

Parameter	Value			Unit	Remarks
	Min	Typ	Max		
Sector erase time (2 Kbyte sector)	—	0.2* ¹	0.5* ²	s	The time of writing 00 _H prior to erasure is excluded.
Sector erase time (16 Kbyte sector)	—	0.5* ¹	7.5* ²	s	The time of writing 00 _H prior to erasure is excluded.
Byte writing time	—	21	6100* ²	μs	System-level overhead is excluded.
Program/erase cycle	100000	—	—	cycle	
Power supply voltage at program/erase	3.0	—	5.5	V	
Flash memory data retention time	20* ³	—	—	year	Average T _A = +85°C

*1: T_A = +25°C, V_{CC} = 5.0 V, 100000 cycles

*2: T_A = +85°C, V_{CC} = 3.0 V, 100000 cycles

*3: This value is converted from the result of a technology reliability assessment. (The value is converted from the result of a high temperature accelerated test using the Arrhenius equation with the average temperature being +85°C).

18. Sample Characteristics

Power supply current temperature characteristics

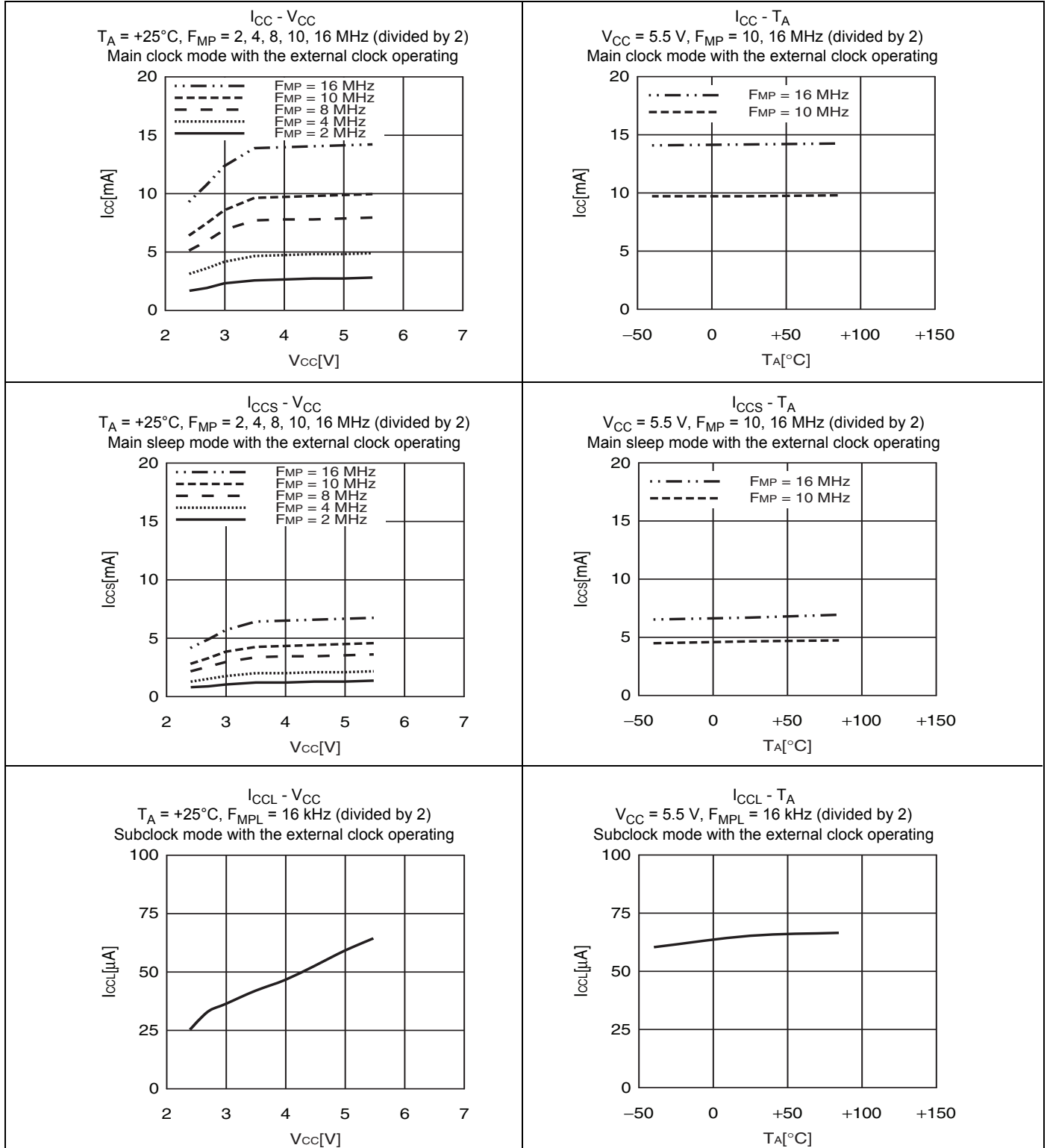

(Continued)

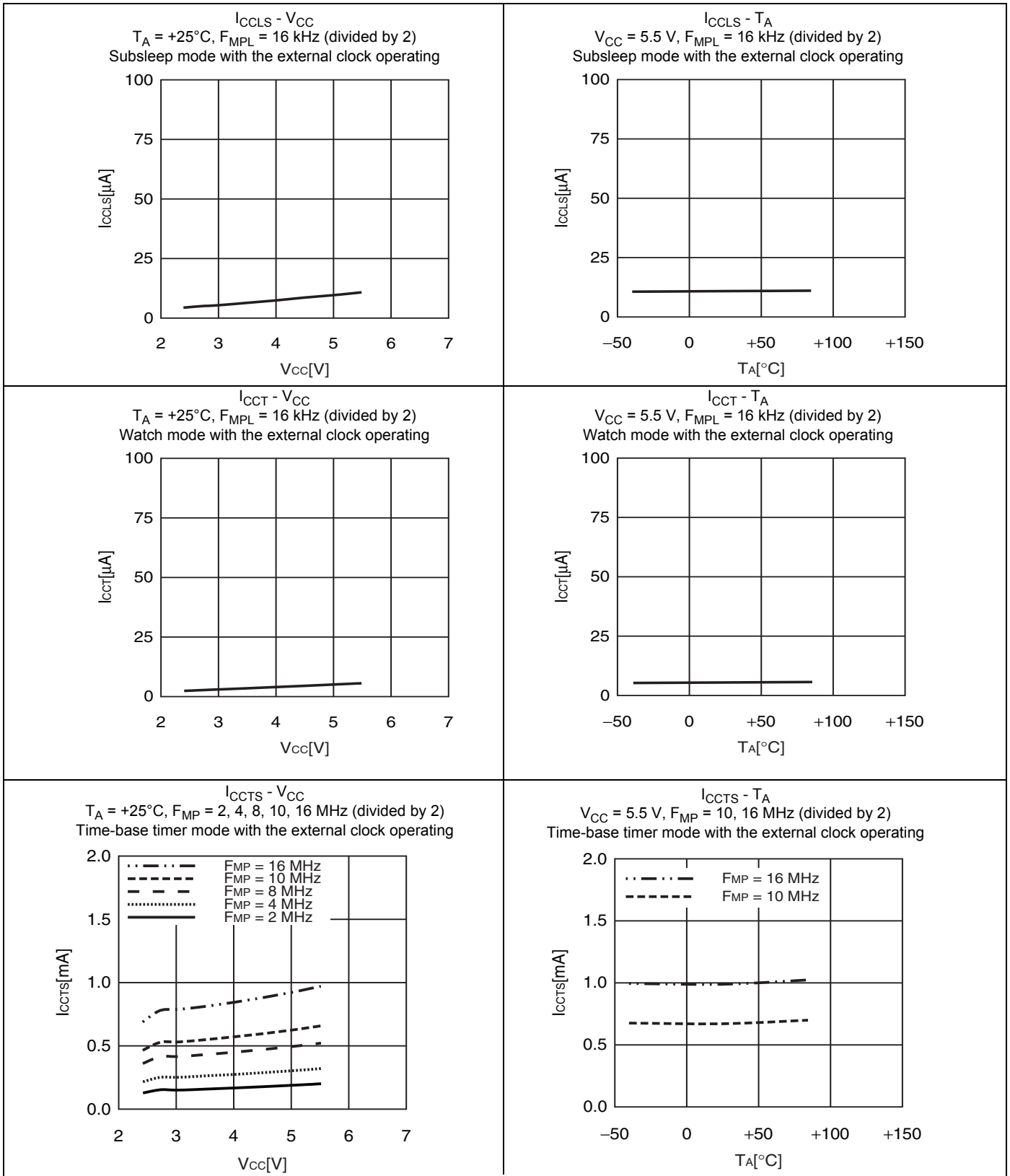

(Continued)

(Continued)

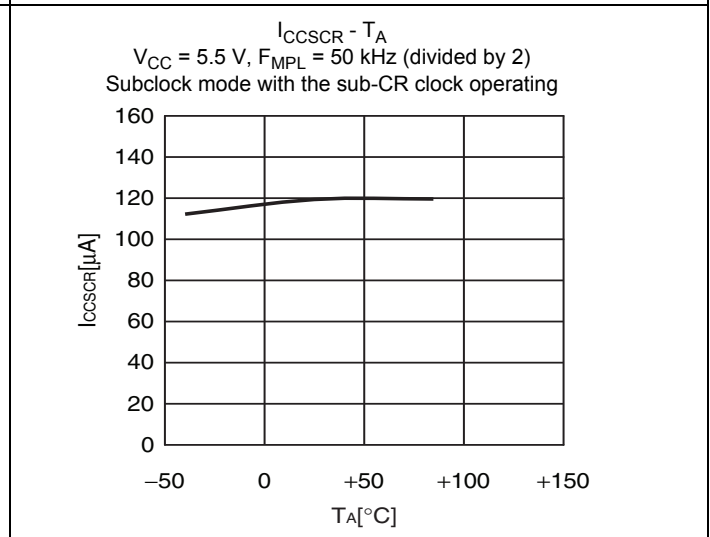
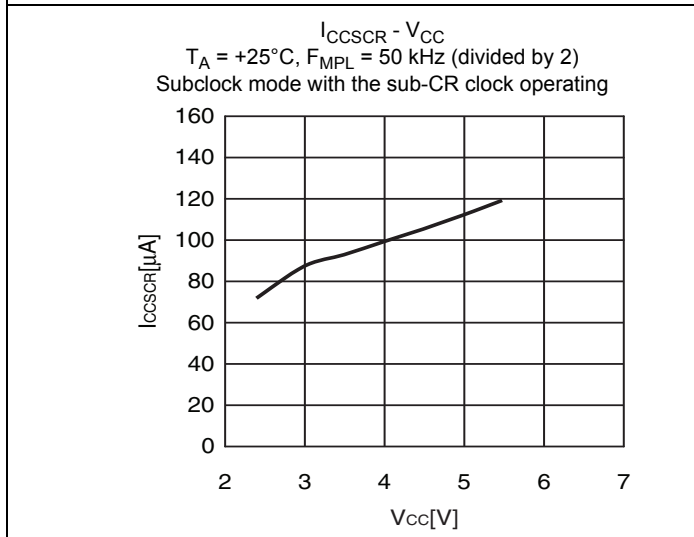
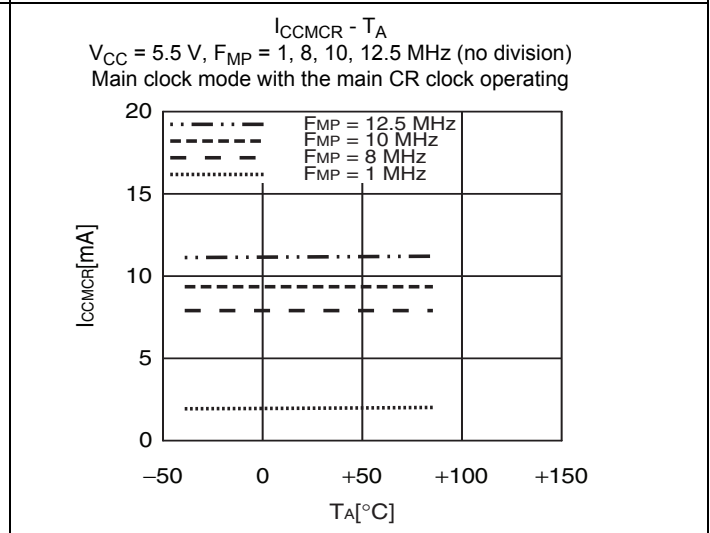
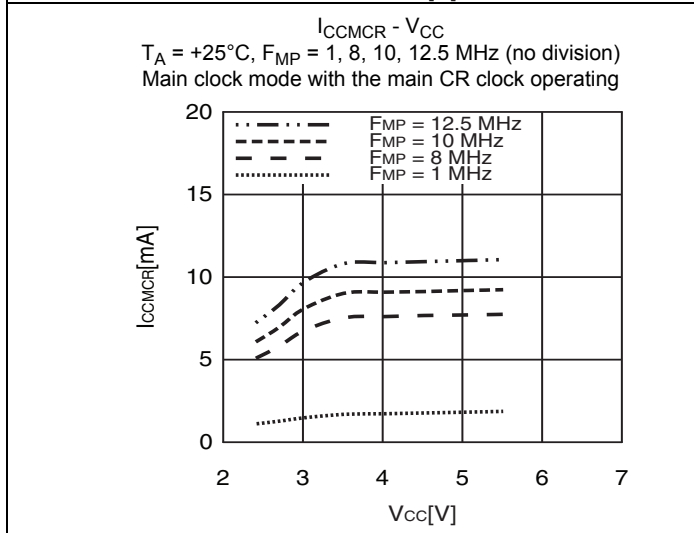
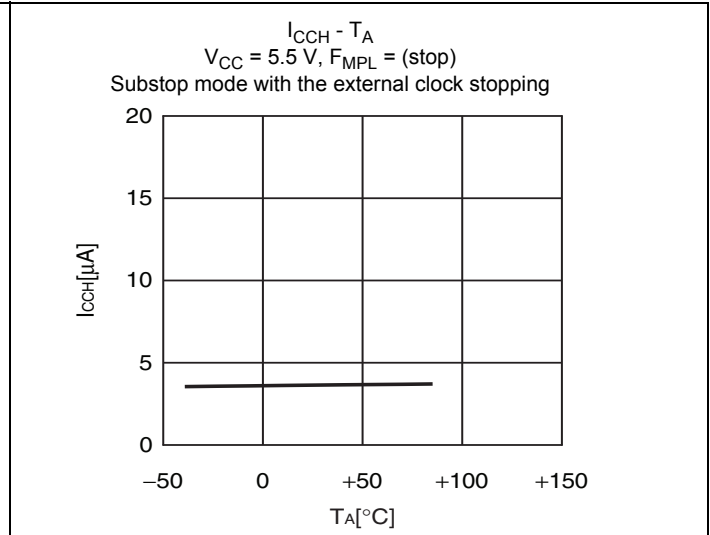
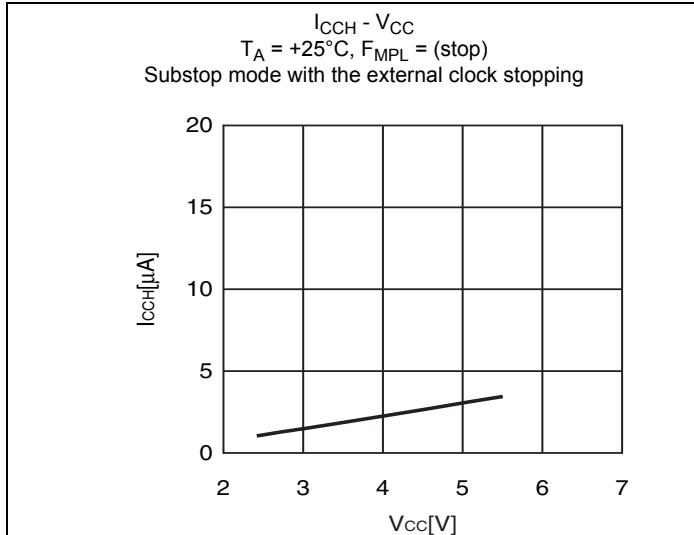

Input voltage characteristics

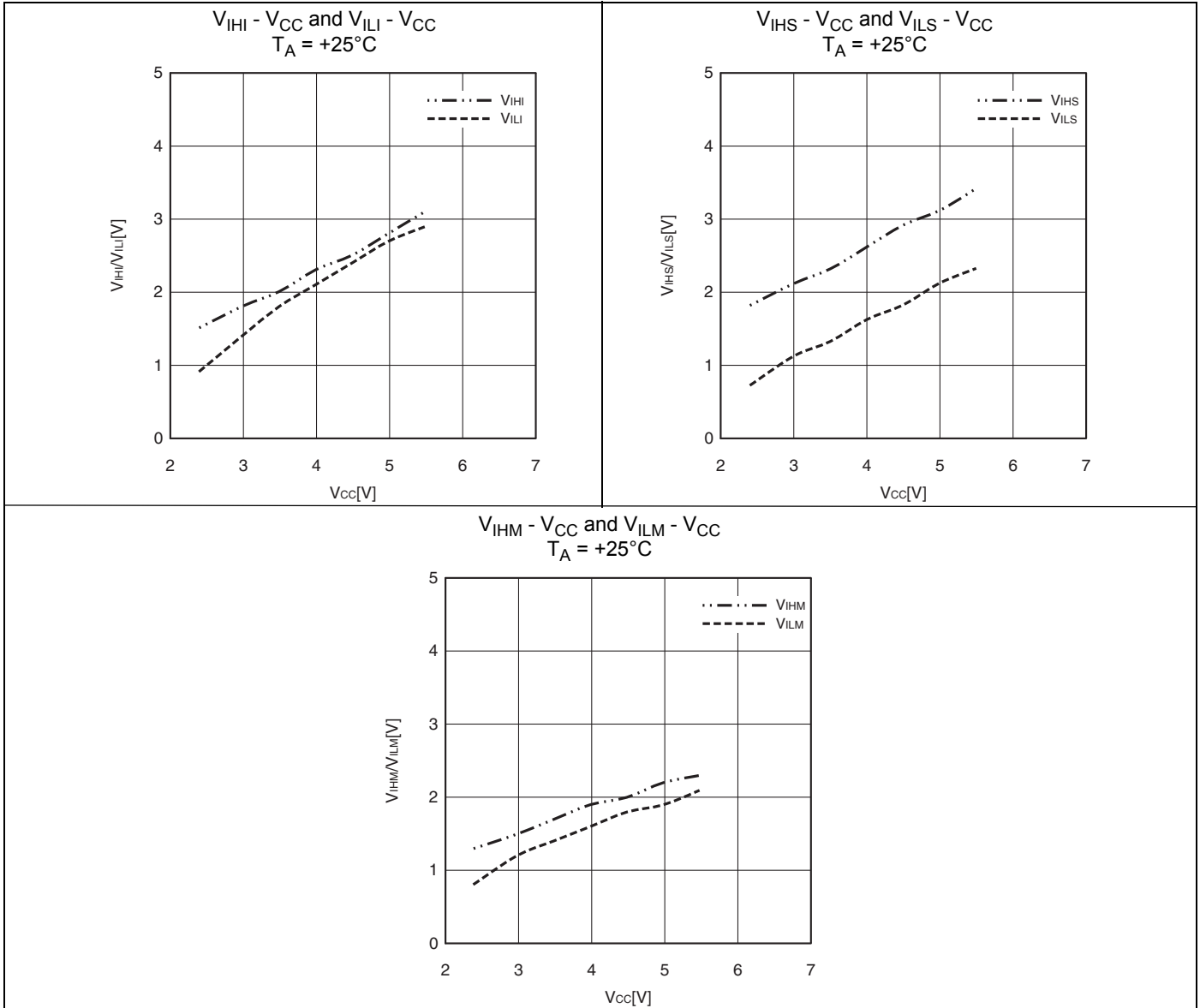

Output voltage characteristics

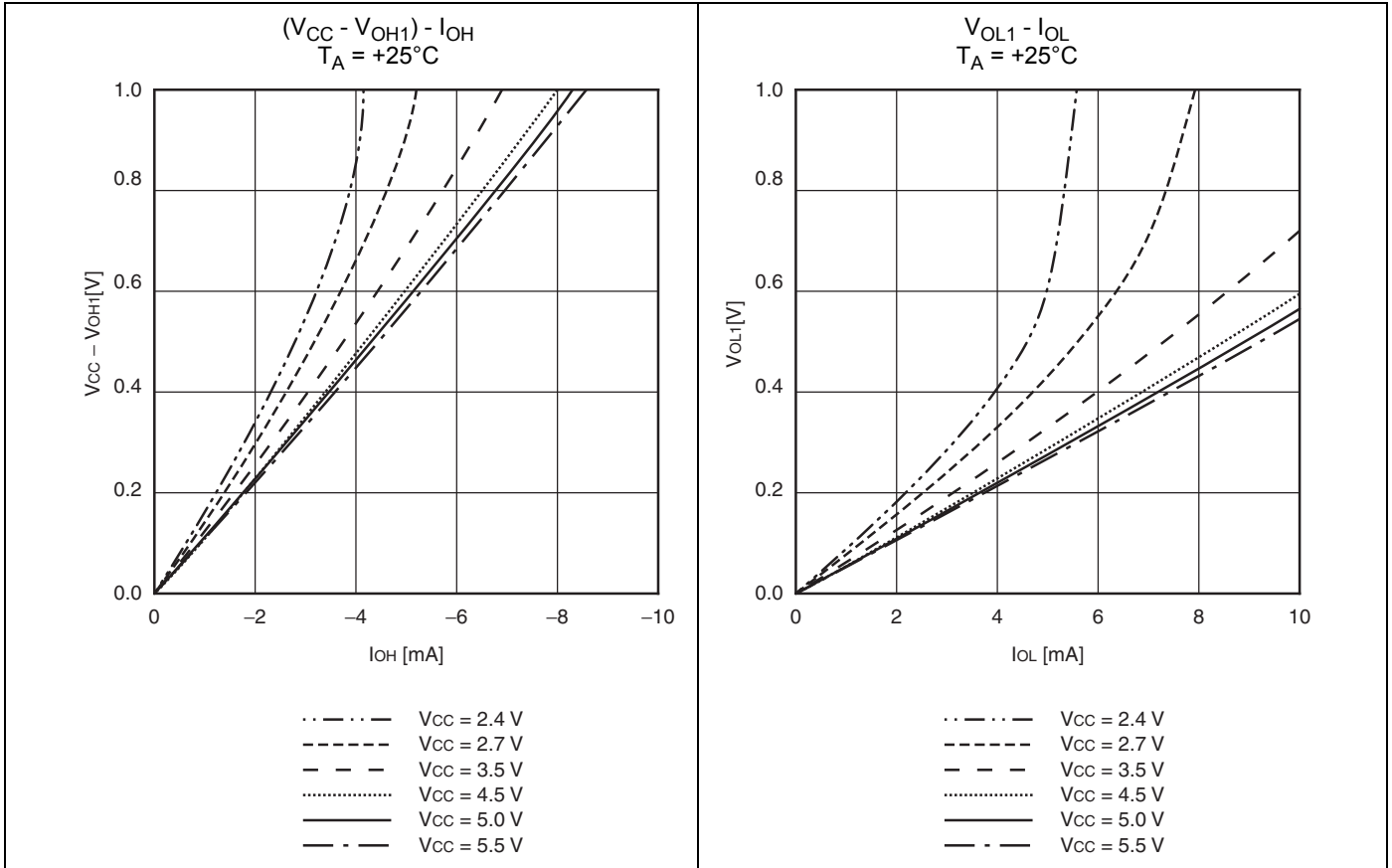

Pull-up characteristics

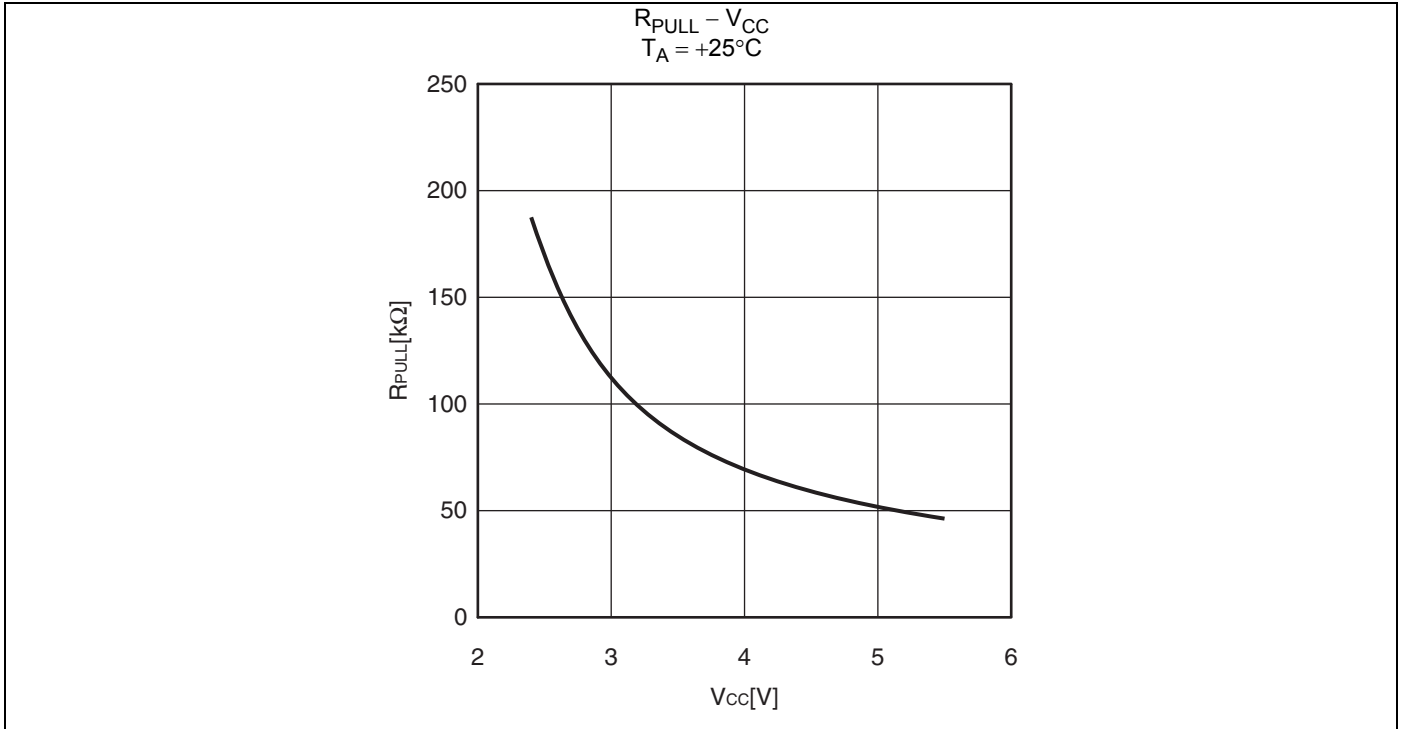

19. Mask Options

No.	Part Number	MB95F414H MB95F416H MB95F418H MB95F474H MB95F476H MB95F478H	MB95F414K MB95F416K MB95F418K MB95F474K MB95F476K MB95F478K
	Selectable/Fixed	Fixed	
1	Low-voltage detection reset	Without low-voltage detection reset	With low-voltage detection reset
2	Reset	With dedicated reset input	Without dedicated reset input

20. Ordering Information

Part Number	Package
MB95F414HPMC-G-SNE2 MB95F414KPMC-G-SNE2 MB95F416HPMC-G-SNE2 MB95F416KPMC-G-SNE2 MB95F418HPMC-G-SNE2 MB95F418KPMC-G-SNE2	80-pin plastic LQFP (FPT-80P-M37)
MB95F474HPMC1-G-SNE2 MB95F474KPMC1-G-SNE2 MB95F476HPMC1-G-SNE2 MB95F476KPMC1-G-SNE2 MB95F478HPMC1-G-SNE2 MB95F478KPMC1-G-SNE2	64-pin plastic LQFP (FPT-64P-M38)
MB95F474HPMC2-G-SNE2 MB95F474KPMC2-G-SNE2 MB95F476HPMC2-G-SNE2 MB95F476KPMC2-G-SNE2 MB95F478HPMC2-G-SNE2 MB95F478KPMC2-G-SNE2	64-pin plastic LQFP (FPT-64P-M39)

21. Package Dimension

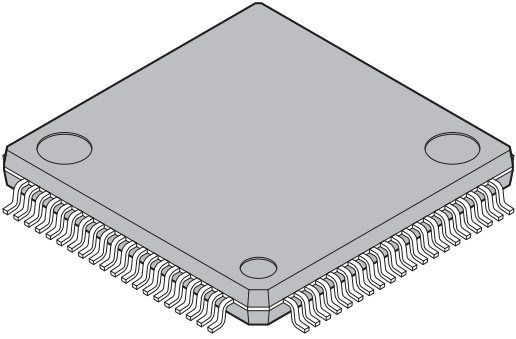
<p style="text-align: center;">80-pin plastic LQFP</p>  <p style="text-align: center;">(FPT-80P-M37)</p>	Lead pitch	0.50 mm
	Package width × package length	12.00 mm × 12.00 mm
	Lead shape	Gullwing
	Lead bend direction	Normal bend
	Sealing method	Plastic mold
	Mounting height	1.70 mm MAX
	Weight	0.47 g

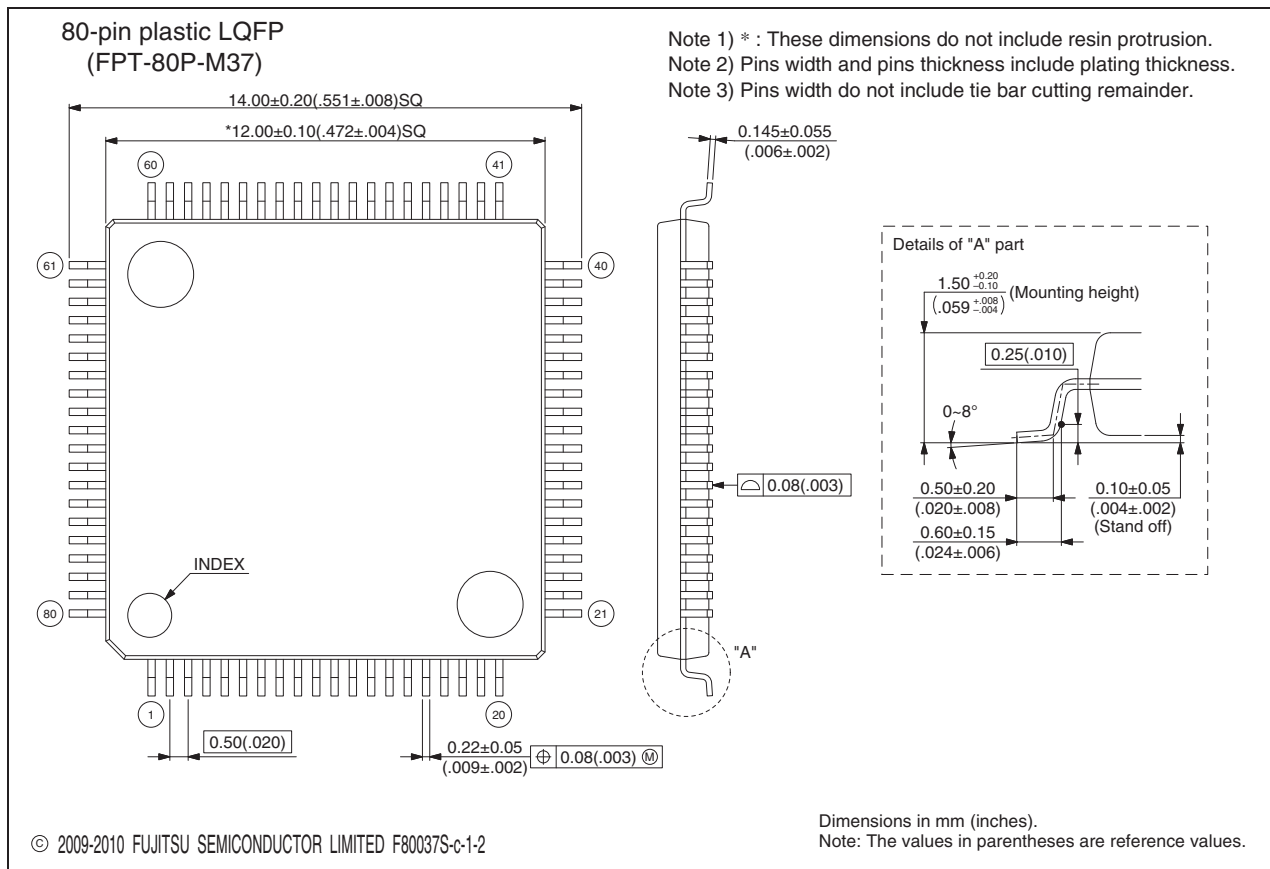

(Continued)

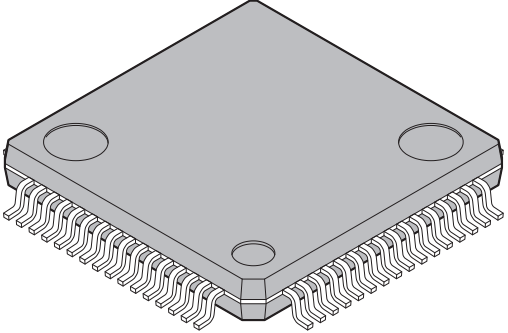
<p style="text-align: center;">64-pin plastic LQFP</p>  <p style="text-align: center;">(FPT-64P-M38)</p>	Lead pitch	0.50 mm
	Package width × package length	10.00 mm × 10.00 mm
	Lead shape	Gullwing
	Lead bend direction	Normal bend
	Sealing method	Plastic mold
	Mounting height	1.70 mm MAX
	Weight	0.32 g

64-pin plastic LQFP (FPT-64P-M38)

Note 1) * : These dimensions do not include resin protrusion.
 Note 2) Pins width and pins thickness include plating thickness.
 Note 3) Pins width do not include tie bar cutting remainder.

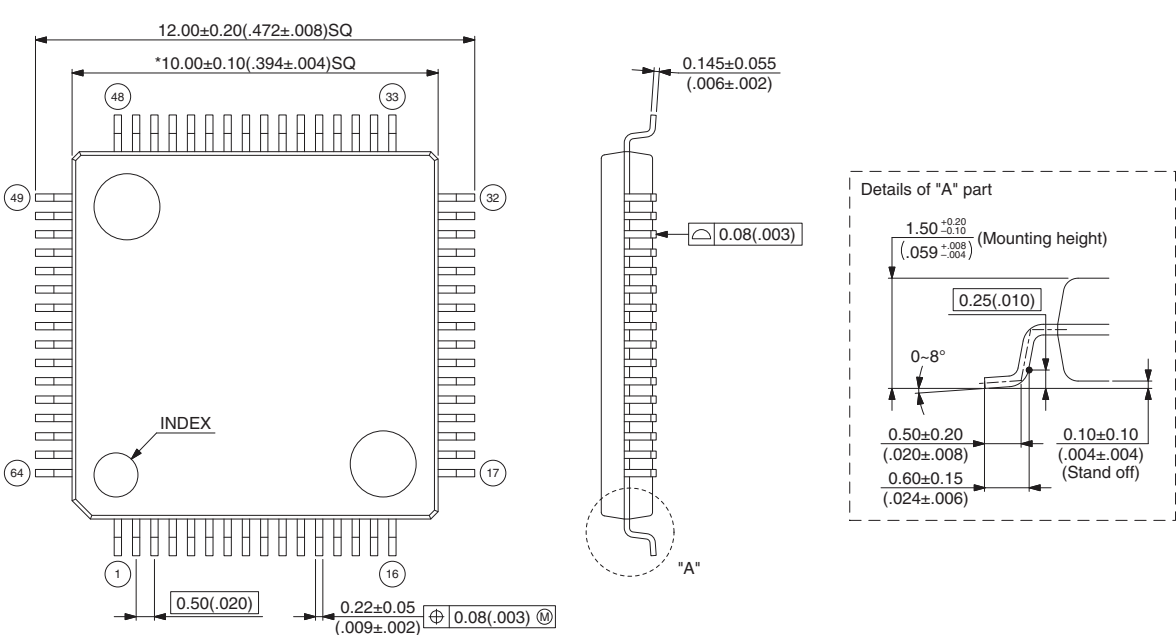

Top view dimensions:
 Overall width: 12.00 ± 0.20 (.472 ± .008) SQ
 Pin pitch: 10.00 ± 0.10 (.394 ± .004) SQ
 Pin 1 location: INDEX
 Pin 16 location: 16
 Pin 17 location: 17
 Pin 32 location: 32
 Pin 33 location: 33
 Pin 48 location: 48
 Pin 49 location: 49
 Pin 64 location: 64

Side view dimensions:
 Lead thickness: 0.145 ± 0.055 (.006 ± .002)
 Lead width: 0.08 (.003)

Details of "A" part:
 Mounting height: $1.50^{+0.20}_{-0.10}$ (.059 $^{+0.008}_{-.004}$)
 Lead thickness: 0.25 (.010)
 Lead angle: 0-8°
 Stand off: 0.10 ± 0.10 (.004 ± .004)
 Pin width: 0.50 ± 0.20 (.020 ± .008)
 Pin thickness: 0.60 ± 0.15 (.024 ± .006)

Bottom view dimensions:
 Pin 1 location: 1
 Pin 16 location: 16
 Pin 17 location: 17
 Pin 32 location: 32
 Pin 33 location: 33
 Pin 48 location: 48
 Pin 49 location: 49
 Pin 64 location: 64
 Pin 16 to 17 distance: 0.22 ± 0.05 (.009 ± .002)
 Pin 17 to 18 distance: 0.50 (.020)
 Pin 18 to 19 distance: 0.08 (.003) Ⓜ

© 2010 FUJITSU SEMICONDUCTOR LIMITED F64038S-c-1-2

Dimensions in mm (inches).
 Note: The values in parentheses are reference values.

(Continued)

(Continued)

<p>64-pin plastic LQFP</p> <p>(FPT-64P-M39)</p>	Lead pitch	0.65 mm
	Package width × package length	12.00 mm × 12.00 mm
	Lead shape	Gullwing
	Sealing method	Plastic mold
	Mounting height	1.70 mm MAX
	Weight	0.47 g

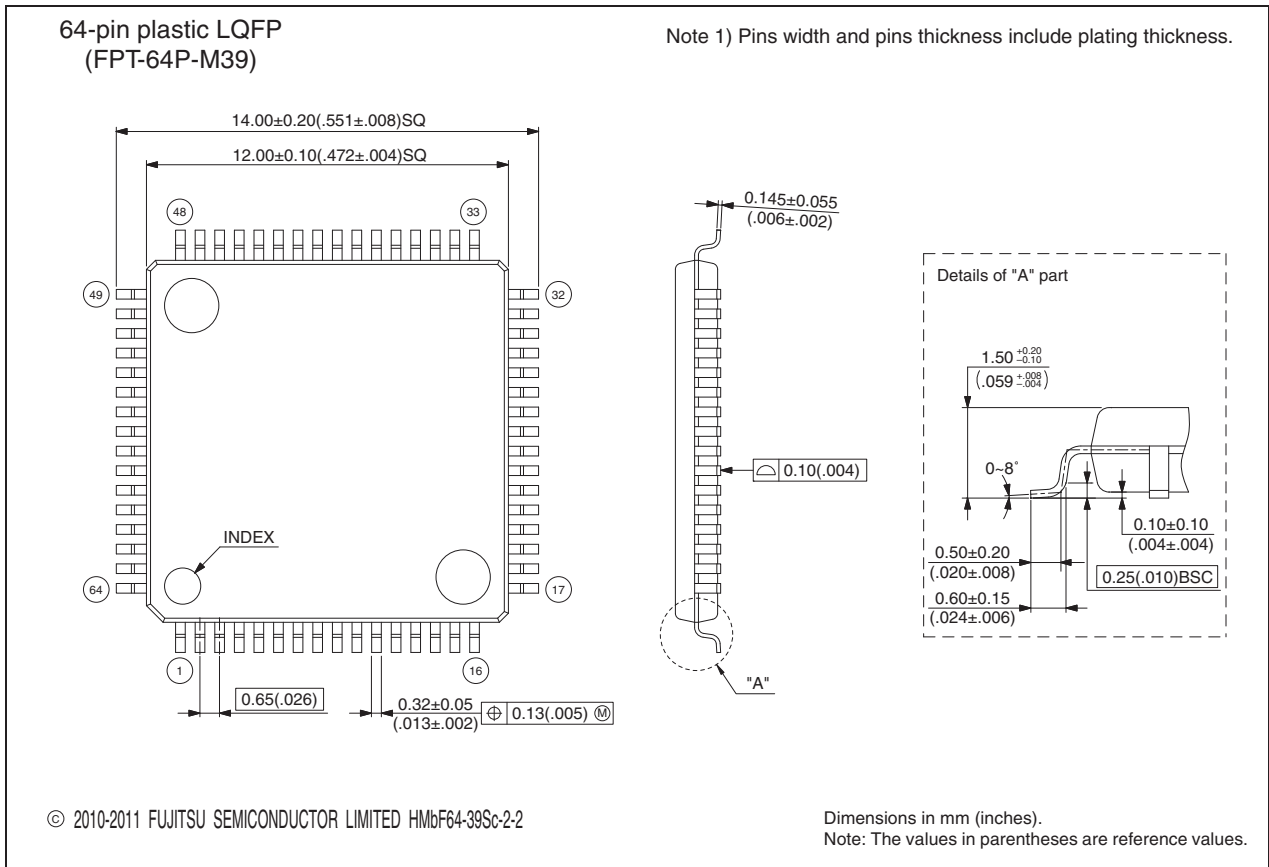

22. Major Changes

Spansion Publication Number: DS702-00004-1v0-E

Page	Section	Details
1	—	Changed the family name. F ² MC-8FX → New 8FX
49 to 51	Electrical Characteristics 3. DC Characteristics	Changed the values of the following power supply current parameters: I _{CC} , I _{CCS} , I _{CCL} , I _{CCLS} , I _{CCT} , I _{CCMPLL} , I _{CCMCR} , I _{CCSCR} , I _{CCTS} , I _{CCH} , I _A , I _V , I _{LVD} .
52	Electrical Characteristics 4. AC Characteristics (1) Clock Timing	Changed the values of the clock frequency (F _{CRH}).
64	Electrical Characteristics 4. AC Characteristics (8) I ² c Timing	Changed the settings related to the machine clock shown in *2.
71 to 76	Sample Characteristics	Added "Sample Characteristics".

NOTE: Please see "Document History" about later revised information.

Document History

Document Title: MB95410H/470H Series New 8FX 8-bit Microcontrollers				
Document Number: 002-07475				
Revision	ECN	Orig. of Change	Submission Date	Description of Change
**	–	AKIH	05/17/2011	Migrated to Cypress and assigned document number 002-07475. No change to document contents or format
*A	5198834	AKIH	04/04/2016	Updated to Cypress format.
*B	5861647	YSAT	08/24/2017	Adapted new Cypress logo

Sales, Solutions, and Legal Information

Worldwide Sales and Design Support

Cypress maintains a worldwide network of offices, solution centers, manufacturer's representatives, and distributors. To find the office closest to you, visit us at [Cypress Locations](#).

Products

ARM® Cortex® Microcontrollers	cypress.com/arm
Automotive	cypress.com/automotive
Clocks & Buffers	cypress.com/clocks
Interface	cypress.com/interface
Internet of Things	cypress.com/iot
Memory	cypress.com/memory
Microcontrollers	cypress.com/mcu
PSoC	cypress.com/psoc
Power Management ICs	cypress.com/pmic
Touch Sensing	cypress.com/touch
USB Controllers	cypress.com/usb
Wireless/RF	cypress.com/wireless

PSoC® Solutions

[PSoC 1](#) | [PSoC 3](#) | [PSoC 4](#) | [PSoC 5LP](#) | [PSoC 6](#)

Cypress Developer Community

[Forums](#) | [WICED IOT Forums](#) | [Projects](#) | [Video](#) | [Blogs](#) | [Training](#) | [Components](#)

Technical Support

cypress.com/support

© Cypress Semiconductor Corporation 2010-2017. This document is the property of Cypress Semiconductor Corporation and its subsidiaries, including Spansion LLC ("Cypress"). This document, including any software or firmware included or referenced in this document ("Software"), is owned by Cypress under the intellectual property laws and treaties of the United States and other countries worldwide. Cypress reserves all rights under such laws and treaties and does not, except as specifically stated in this paragraph, grant any license under its patents, copyrights, trademarks, or other intellectual property rights. If the Software is not accompanied by a license agreement and you do not otherwise have a written agreement with Cypress governing the use of the Software, then Cypress hereby grants you under its copyright rights in the Software, a personal, non-exclusive, nontransferable license (without the right to sublicense) (a) for Software provided in source code form, to modify and reproduce the Software solely for use with Cypress hardware products, only internally within your organization, and (b) to distribute the Software in binary code form externally to end users (either directly or indirectly through resellers and distributors), solely for use on Cypress hardware product units. Cypress also grants you a personal, non-exclusive, nontransferable, license (without the right to sublicense) under those claims of Cypress's patents that are infringed by the Software (as provided by Cypress, unmodified) to make, use, distribute, and import the Software solely to the minimum extent that is necessary for you to exercise your rights under the copyright license granted in the previous sentence. Any other use, reproduction, modification, translation, or compilation of the Software is prohibited.

TO THE EXTENT PERMITTED BY APPLICABLE LAW, CYPRESS MAKES NO WARRANTY OF ANY KIND, EXPRESS OR IMPLIED, WITH REGARD TO THIS DOCUMENT OR ANY SOFTWARE OR ACCOMPANYING HARDWARE, INCLUDING, BUT NOT LIMITED TO, THE IMPLIED WARRANTIES OF MERCHANTABILITY AND FITNESS FOR A PARTICULAR PURPOSE. To the extent permitted by applicable law, Cypress reserves the right to make changes to this document without further notice. Cypress does not assume any liability arising out of the application or use of any product or circuit described in this document. Any information provided in this document, including any sample design information or programming code, is provided only for reference purposes. It is the responsibility of the user of this document to properly design, program, and test the functionality and safety of any application made of this information and any resulting product. Cypress products are not designed, intended, or authorized for use as critical components in systems designed or intended for the operation of weapons, weapons systems, nuclear installations, life-support devices or systems, other medical devices or systems (including resuscitation equipment and surgical implants), pollution control or hazardous substances management, or other uses where the failure of the device or system could cause personal injury, death, or property damage ("Unintended Uses"). A critical component is any component of a device or system whose failure to perform can be reasonably expected to cause the failure of the device or system, or to affect its safety or effectiveness. Cypress is not liable, in whole or in part, and you shall and hereby do release Cypress from any claim, damage, or other liability arising from or related to all Unintended Uses of Cypress products. You shall indemnify and hold Cypress harmless from and against all claims, costs, damages, and other liabilities, including claims for personal injury or death, arising from or related to any Unintended Uses of Cypress products.

Cypress, the Cypress logo, Spansion, the Spansion logo, and combinations thereof, WICED, PSoC, CapSense, EZ-USB, F-RAM, and Traveo are trademarks or registered trademarks of Cypress in the United States and other countries. For a more complete list of Cypress trademarks, visit cypress.com. Other names and brands may be claimed as property of their respective owners.

X-ON Electronics

Largest Supplier of Electrical and Electronic Components

Click to view similar products for [8-bit Microcontrollers - MCU category](#):

Click to view products by [Cypress manufacturer](#):

Other Similar products are found below :

[CY8C20524-12PVXIT](#) [MB95F013KPMC-G-SNE2](#) [MB95F263KPF-G-SNE2](#) [MB95F264KPFT-G-SNE2](#) [MB95F398KPMC-G-SNE2](#)
[MB95F478KPMC2-G-SNE2](#) [MB95F564KPF-G-SNE2](#) [MB95F636KWQN-G-SNE1](#) [MB95F696KPMC-G-SNE2](#) [MB95F698KPMC2-G-SNE2](#)
[MB95F698KPMC-G-SNE2](#) [MB95F818KPMC1-G-SNE2](#) [901015X](#) [CY8C3MFIDOCK-125](#) [403708R](#) [MB95F354EPF-G-SNE2](#)
[MB95F564KWQN-G-SNE1](#) [MB95F636KP-G-SH-SNE2](#) [MB95F694KPMC-G-SNE2](#) [MB95F778JPMC1-G-SNE2](#) [MB95F818KPMC-G-SNE2](#)
[LC87F0G08AUJA-AH](#) [CP8361BT](#) [CG8421AF](#) [MB95F202KPF-G-SNE2](#) [DF36014FPV](#) [5962-8768407MUA](#) [MB95F318EPMC-G-SNE2](#)
[MB94F601APMC1-GSE1](#) [MB95F656EPF-G-SNE2](#) [LC78615E-01US-H](#) [LC87F5WC8AVU-QIP-H](#) [MB95F108AJSPMC-G-JNE1](#) [73S1210F-](#)
[68M/F/PJ](#) [MB89F538-101PMC-GE1](#) [LC87F7DC8AVU-QIP-H](#) [MB95F876KPMC-G-SNE2](#) [MB88386PMC-GS-BNDE1](#) [LC87FBK08AU-](#)
[SSOP-H](#) [LC87F2C64AU-QFP-H](#) [MB95F636KNWQN-G-118-SNE1](#) [MB95F136NBSTPFV-GS-N2E1](#) [LC87F5NC8AVU-QIP-E](#)
[LC87F76C8AU-TQFP-E](#) [LC87F2G08AU-SSOP-E](#) [CP8085AT](#) [MB95F564KPF-G-UNE2](#) [MC9S08QG8CDTE](#) [UPD78F0532AGA\(S\)-HAB-](#)
[AX](#) [PIC12CE674-04/P](#)