



4ch DC/DC Converter with I²C Interface and Internal SW FETs

S6AP413A contains 3ch buck DC/DC converter and 1ch buck-boost DC/DC converter. S6AP413A can supply the main power line in several systems by using only its chip. The current mode control is adopted for the DC/DC converter, and it is possible to use the small chip inductor with the high switching frequency operation which contains internal switching FETs. S6AP413A contains the output setting resistor and the phase compensation circuit, and contributes to reduce the number of external components and its mount area. Also it contains the CTL input pin which can control the ON/OFF for each DC/DC converter, the Power Good signal output pin and I²C communication interface, therefore it is easy to design the power supply sequence. It is possible to tune in the output voltage exactly using the I²C communication.

Features

- Operating input voltage range: 2.5V to 5.5V (Maximum rating: 6.5V)
 - Output voltage setting range: DD1*:0.7V to 1.32V (20mV/step)
DD2*:1.2V to 1.95V (50mV/step)
DD3*:2.8V to 3.5V (100mV/step)
DD4*:0.7V to 1.32V (20mV/step)
 - Maximum output current: DD1:2A, DD2:1.2A, DD3:0.6A, DD4:2A
 - Internal switching FETs, output voltage setting resistor, phase compensation circuit and output discharge resistor (all DC/DC converters)
 - Buck-boost DC/DC converter is seamless to change operation mode
 - Soft start time setting range: 1 ms to 16 ms (approximately 1ms/step)
 - Switching frequency for the DC/DC converter: 3 MHz
 - Communication interface: I²C (ON/OFF, Output voltage, Soft start time)
 - Internal PFM/PWM auto switching mode
 - Each DC/DC converter Power Good function (open drain)
 - Several protection functions: Under voltage lockout (UVLO), Over current protection (OCP), Thermal shut down (TSD)
 - Small package: QFN32 (5mm × 5mm × 0.71mm, 0.5mm pitch)
- *: DD1, DD2, DD3, and DD4: DC/DC converter blocks 1,2,3,4

Applications

Network equipment, Factory automation, Security system, Surveillance camera, Electrical music instrument, Multi-function printer, Scanner, Printer, Copy machine, Home appliances, Data storage (HDD, SSD), Mobile equipment for Li+ battery (1 cell)

Contents

1. Application Circuit Example	4
2. Recommended Application Specification.....	5
3. Pin Configuration.....	8
4. Pin Descriptions.....	9
5. Block Diagram.....	10
6. Absolute Maximum Ratings	11
7. Recommended Operating Conditions.....	12
8. Electrical Characteristics	13
8.1 Reference Control Block.....	13
8.2 DD1	14
8.3 DD2	15
8.4 DD3	16
8.5 DD4	17
8.6 Digital Block.....	18
9. Operation Mode List	19
10. State Transition Diagram.....	20
11. Turning ON and OFF Sequence (AVCC=CTLMAIN, CTL1, CTL2, CTL3, CTL4).....	21
12. Turning ON and OFF Sequence (AVCC →CTLMAIN→CTL1→CTL2→ CTL3→ CTL4).....	22
13. Turning ON and OFF Sequence (AVCC→CTLMAIN→I²C)	23
14. CTL Pin Threshold Voltage	24
15. Protection Operation Sequence.....	25
16. Operation Condition, Stop Circuit and Release Condition for Protection Circuit.....	26
17. DD Soft Start Operation.....	27
18. Discharge Operation.....	28
19. PG Function.....	29
20. I²CInterface	30
20.1 Structure of I ² CInterface	30
20.2 Definition of Signal Lines.....	30
20.3 Validity of Data	31
20.4 Definition of Start and Stop Condition.....	31
20.5 ACK Signal.....	32
20.6 I ² C Interface Input Timing.....	33
20.7 Slave Address	34
20.8 Bit Structure of Data on I ² C Interface	35
21. Structure of I²C Interface and Data.....	37
21.1 About DD1, DD4Output Voltage Setting.....	38
21.2 About DD2 Output Voltage Setting.....	39
21.3 About DD3 Output Voltage Setting.....	40
21.4 About Soft Start Time	41
21.5 DC/DC Operation Mode	42
21.6 ON/OFF for DC/DC	43
21.7 About Error Monitor	44
21.8 About Power Good Monitor	45
22. I/O Pin Equivalent Circuit Diagram	46
23. Measurement Circuit for Characteristics of General Operation	49
24. Reference Data.....	51
25. Ordering Information	63
26. Preset Code List.....	64

27. Layout	65
28. Package Dimensions	66
29. Major Changes	67
Document History.....	68

1. Application Circuit Example

Figure 1. Application Circuit

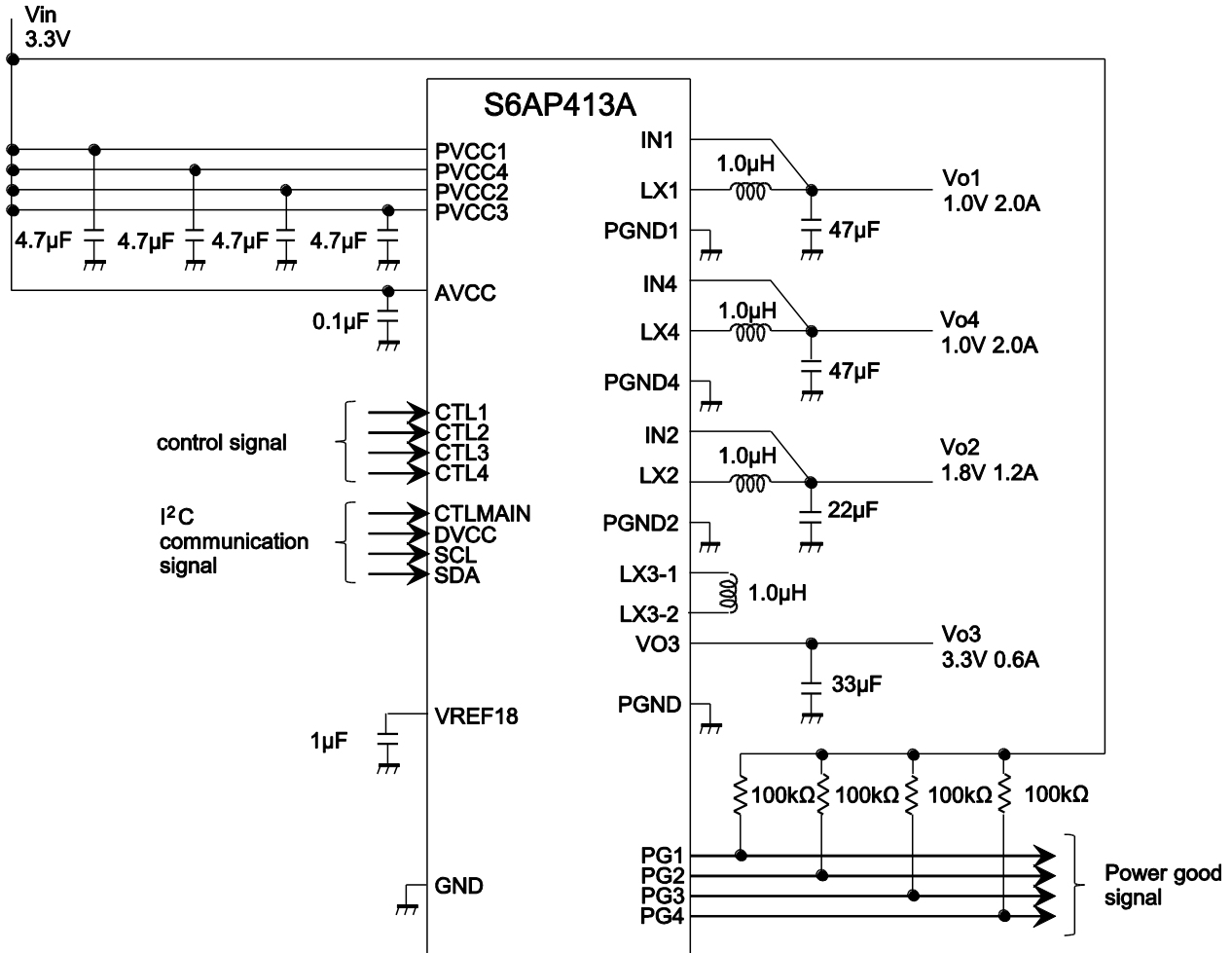

2. Recommended Application Specification

[Input Voltage Range]

Input Voltage Vin(V)		
Min	Typ	Max
2.5	3.3	5.5

[Output specification]

(Ta=+25°C)

Channel	Symbol	Accuracy	Output Voltage (V)			Output Current(mA)	Limit Current(mA)	Mode	Switching Frequency(MHz)	Inductor(μH)	Output Capacitance	Soft-start Time (ms)	Discharge Resistance (kΩ)	Remarks
			Min	Typ	Max	Max	Min							
DD1	VO1	±1.2 %	0.692	0.700	0.708	2000	(2400)	Buck (synchronous rectification) C-mode	3.0	1.0	22	1 to 16ms At the time of 1.0V setting, the details are cf. Contents 17	5.0	Built-in SWFET Built-in output setting resistors Built-in phase compensation circuit
			0.711	0.720	0.729									
			0.731	0.740	0.749									
			0.751	0.760	0.769									
			0.771	0.780	0.789									
			0.790	0.800	0.810									
			0.810	0.820	0.830									
			0.830	0.840	0.850									
			0.850	0.860	0.870									
			0.869	0.880	0.891									
			0.889 (*1)	0.900 (*1)	0.911 (*1)									
			0.909	0.920	0.931									
			0.929	0.940	0.951									
			0.948	0.960	0.972									
			0.968	0.980	0.992									
			0.988 (*1)	1.000 (*1)	1.012 (*1)									
			1.008	1.020	1.032									
			1.028	1.040	1.052									
			1.047	1.060	1.073									
			1.067	1.080	1.093									
			1.087 (*1)	1.100 (*1)	1.113 (*1)									
			1.107	1.120	1.133									
			1.126	1.140	1.154									
1.146	1.160	1.174												
1.166	1.180	1.194												
1.186 (*1)	1.200 (*1)	1.214 (*1)												
1.205	1.220	1.235												
1.225	1.240	1.255												
1.245	1.260	1.275												
1.265	1.280	1.295												
1.284	1.300	1.316												
1.304	1.320	1.336												

Channel	Symbol	Accuracy	Output Voltage (V)			Output Current(mA)	Limit Current(mA)	Mode	Switching Frequency(MHz)	Inductor(μH)	Output Capacitance	Soft-start Time (ms)	Discharge Resistance (kΩ)	Remarks
			Min	Typ	Max	Max	Min							
DD2	VO2	±1.2 %	1.186 (*1)	1.200 (*1)	1.214 (*1)	1200	(1500)	Buck (synchronous rectification) C-mode	3.0	1.0	10	1 to 16ms At the time of 1.8V setting, the details are cf. Contents 17	5.0	Built-in SWFET Built-in output setting resistors Built-in phase compensation circuit
			1.235	1.250	1.265									
			1.284	1.300	1.316									
			1.334 (*1)	1.350 (*1)	1.366 (*1)									
			1.383	1.400	1.417									
			1.433	1.450	1.467									
			1.482 (*1)	1.500 (*1)	1.518 (*1)									
			1.531	1.550	1.569									
			1.581	1.600	1.619									
			1.630	1.650	1.670									
			1.680	1.700	1.720									
			1.729	1.750	1.771									
			1.778 (*1)	1.800 (*1)	1.822 (*1)									
			1.828	1.850	1.872									
1.877	1.900	1.923												
1.927	1.950	1.973												
DD3	VO3	±1.8 %	2.74 (*1)	2.80 (*1)	2.86 (*1)	600	(750)	Buck-boost (synchronous rectification) C-mode	3.0	1.0	22	1 to 16ms At the time of 3.3V setting, the details are cf. Contents 17	5.0	Built-in SWFET Built-in output setting resistors Built-in phase compensation circuit
			2.84	2.90	2.96									
			2.94 (*1)	3.00 (*1)	3.06 (*1)									
			3.04	3.10	3.16									
			3.14	3.20	3.26									
			3.23 (*1)	3.30 (*1)	3.37 (*1)									
			3.33	3.40	3.47									
			3.43 (*1)	3.50 (*1)	3.57 (*1)									

Channel	Symbol	Accuracy	Output Voltage (V)			Output Current(mA)	Limit Current(mA)	Mode	Switching Frequency(MHz)	Inductor(μH)	Output Capacitance	Soft-start Time (ms)	Discharge Resistance (kΩ)	Remarks
			Min	Typ	Max	Max	Min							
DD4	VO4	±1.2 %	0.692	0.700	0.708	2000	(2400)	Buck (synchronous rectification) C-mode	3.0	1.0	22	1 to 16ms At the time of 1.8V setting, the details are cf. Contents 17	5.0	Built-in SWFE T Built-in output setting resistors Built-in phase compensation circuit
			0.711	0.720	0.729									
			0.731	0.740	0.749									
			0.751	0.760	0.769									
			0.771	0.780	0.789									
			0.790	0.800	0.810									
			0.810	0.820	0.830									
			0.830	0.840	0.850									
			0.850	0.860	0.870									
			0.869	0.880	0.891									
			0.889 (*1)	0.900 (*1)	0.911(*1)									
			0.909	0.920	0.931									
			0.929	0.940	0.951									
			0.948	0.960	0.972									
			0.968	0.980	0.992									
			0.988 (*1)	1.000 (*1)	1.012 (*1)									
			1.008	1.020	1.032									
			1.028	1.040	1.052									
			1.047	1.060	1.073									
			1.067	1.080	1.093									
			1.087 (*1)	1.100 (*1)	1.113 (*1)									
			1.107	1.120	1.133									
			1.126	1.140	1.154									
1.146	1.160	1.174												
1.166	1.180	1.194												
1.186 (*1)	1.200 (*1)	1.214 (*1)												
1.205	1.220	1.235												
1.225	1.240	1.255												
1.245	1.260	1.275												
1.265	1.280	1.295												
1.284	1.300	1.316												
1.304	1.320	1.336												

*1:default(It is selectable with the default output voltage)

3. Pin Configuration

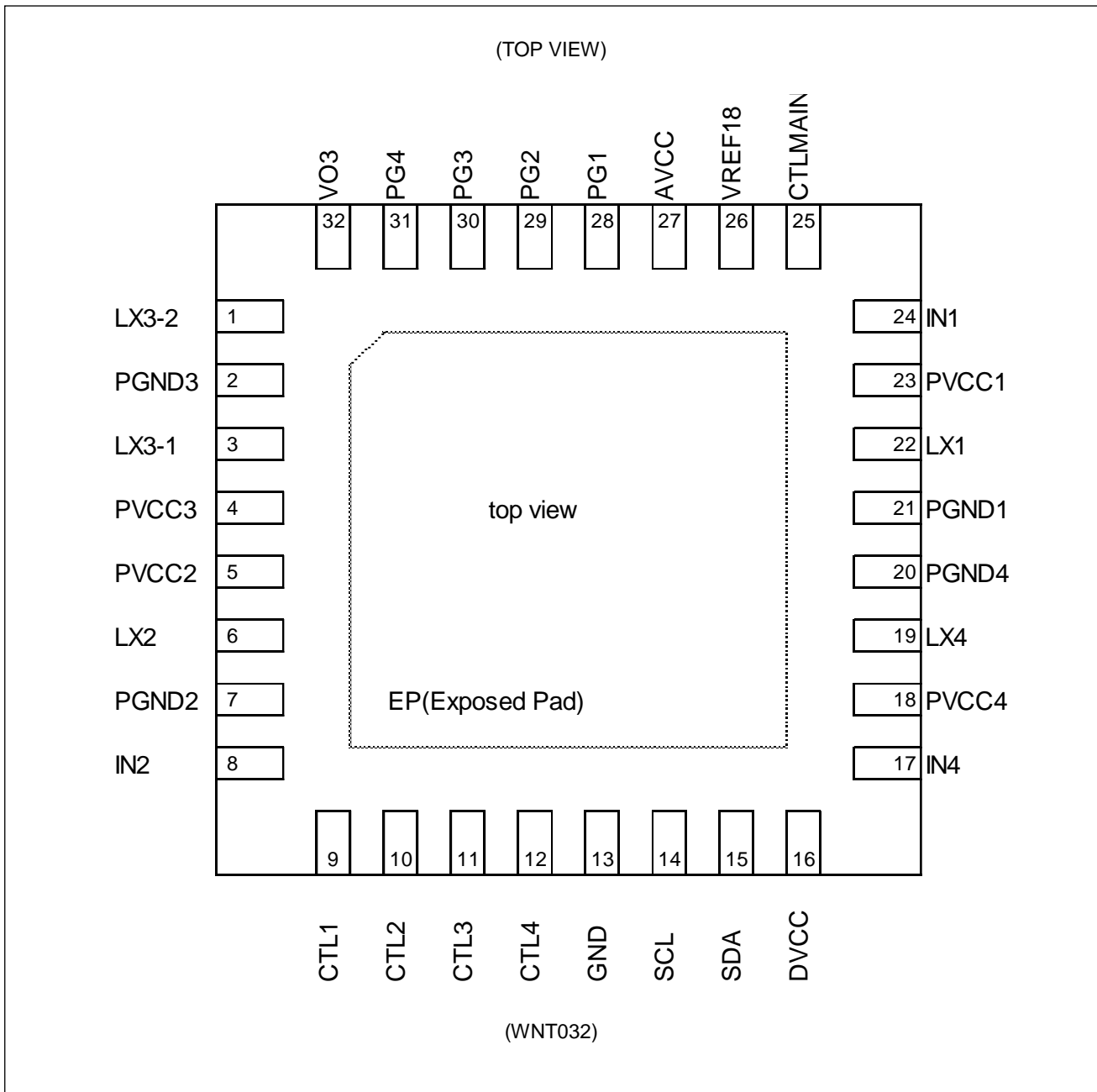

4. Pin Descriptions

Block	Pin Name	Pin Number	I/O	Description	Pull-down Resistor	Unused DD1	Unused DD2	Unused DD3	Unused DD4	Unused I ² C
DD1 Buck	IN1	24	I	DD1 output voltage feedback	-	GND	-	-	-	-
	PVCC1	23	-	DD1 output block power supply	-	AVCC	-	-	-	-
	LX1	22	O	DD1 inductor connection	-	Open	-	-	-	-
	PG1	28	O	DD1 Power Good output	-	GND	-	-	-	-
	PGND1	21	O	DD1 output block ground	-	GND	-	-	-	-
DD2 Buck	IN2	8	I	DD2 output voltage feedback	-	-	GND	-	-	-
	PVCC2	5	-	DD2 output block power supply	-	-	AVCC	-	-	-
	LX2	6	O	DD2 inductor connection	-	-	Open	-	-	-
	PG2	29	O	DD2 Power Good output	-	-	GND	-	-	-
	PGND2	7	-	DD2 output block ground	-	-	GND	-	-	-
DD3 Buck-boost	PVCC3	4	-	Power supply for DD3 output block	-	-	-	AVCC	-	-
	VO3	32	O	Output voltage for DD3	-	-	-	GND	-	-
	LX3-1	3	O	DD3 inductor connection1	-	-	-	Open	-	-
	LX3-2	1	O	DD3 inductor connection2	-	-	-	Open	-	-
	PG3	30	O	Output for DD3 Power Good	-	-	-	GND	-	-
	PGND3	2	-	Ground for DD3 output block	-	-	-	GND	-	-
DD4 Buck	IN4	17	-	DD4 output voltage feedback	-	-	-	-	GND	-
	PVCC4	18	-	DD4 output block power supply	-	-	-	-	AVCC	-
	LX4	19	O	DD4 inductor connection	-	-	-	-	Open	-
	PG4	31	O	DD4 Power Good output	-	-	-	-	GND	-
	PGND4	20	-	DD4 output block ground	-	-	-	-	GND	-
CTL	CTLM AIN	25	I	Control for reference voltage output	Exist	-	-	-	-	-
	CTL1	9	I	DD1 control	Exist	Open	-	-	-	-
	CTL2	10	I	DD2 control	Exist	-	Open	-	-	-
	CTL3	11	I	DD3 control	Exist	-	-	Open	-	-
	CTL4	12	I	DD4 control	Exist	-	-	-	Open	-
I ² C	DVCC	16	I	Power supply for I ² C communication	-	-	-	-	-	GND
	SCL	14	I	Clock for I ² C communication	-	-	-	-	-	Open
	SDA	15	I/O	Data for I ² C communication	Exist	-	-	-	-	Open
Reference control	AVCC	27	-	Power supply for reference voltage	-	-	-	-	-	-
	VREF18	26	O	Output reference voltage	-	-	-	-	-	-
	GND	13	-	Ground for reference voltage	-	-	-	-	-	-
	GND	EP	-	Ground for reference voltage	-	-	-	-	-	-

5. Block Diagram

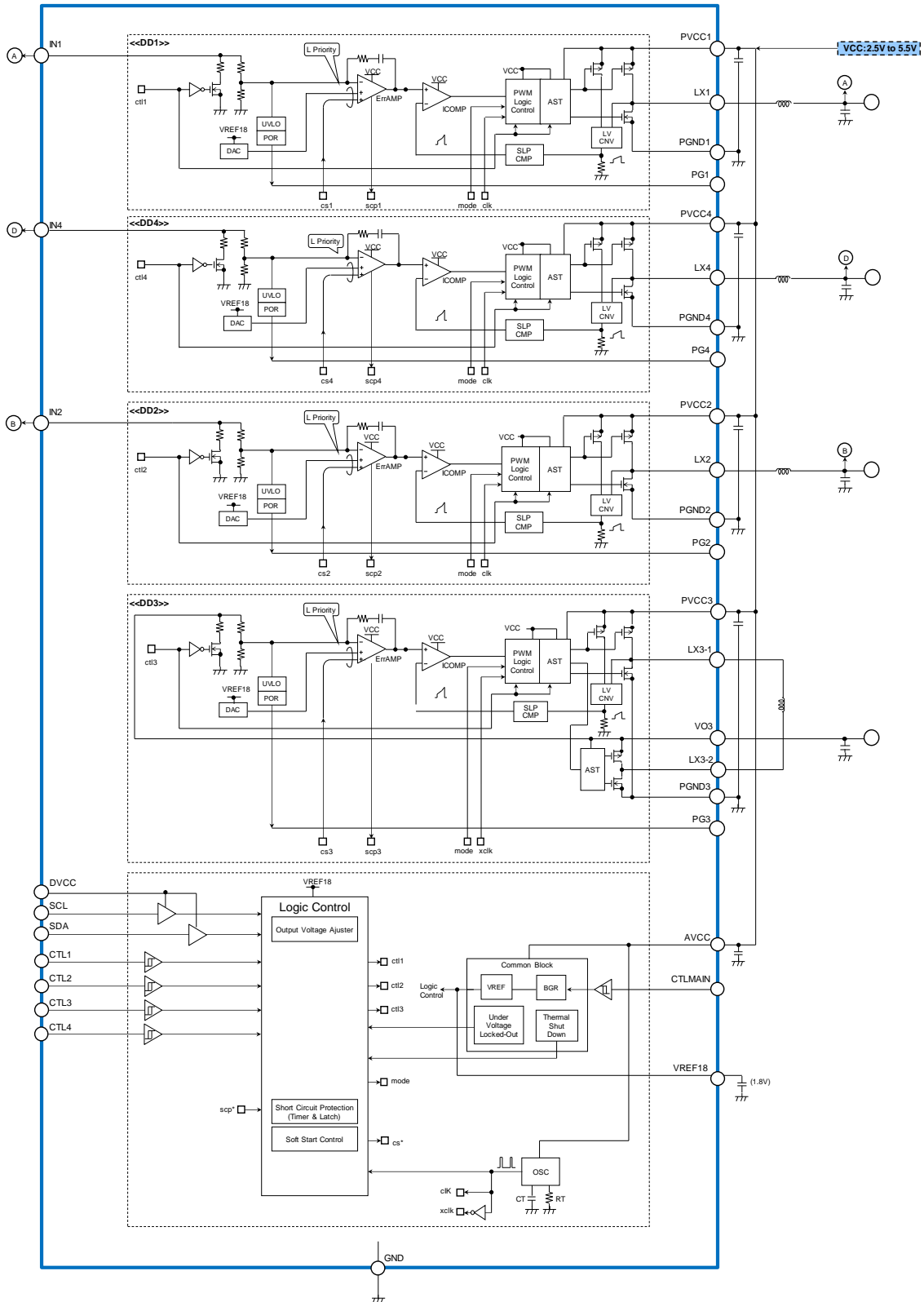

6. Absolute Maximum Ratings

Parameter	Symbol	Condition	Rating		Unit
			Min	Max	
Power supply voltage	V _{VCC1}	AVCC, PVCC input voltage	-0.3	6.5	V
	V _{VCC2}	DVCC input voltage	-0.3	6.5	V
Terminal voltage	V _{CTL1}	CTL1, CTL2, CTL3 input voltage	-0.3	6.5	V
	V _{CTL2}	CTLMAIN input voltage	-0.3	6.5	V
	V _{LOGIC}	SDA, SCL input voltage	-0.3	6.5	V
	V _{PG}	PG1, PG2, PG3, PG4 drain voltage	-0.3	6.5	V
	V _{OUT}	IN1, IN2, IN3, IN4 input voltage	-0.3	6.5	V
LX voltage	V _{LX}	LX1, LX2, LX3, LX4 voltage	-1.0	6.5	V
Permission loss	P _D	T _a ≤ +25°C Thermal resistance(θ _{ja}):(29.2°C /W(*1))	0	3420	mW
Maximum junction temperature	T _{jmax}	-	-	+125	°C
Storage temperature	T _{STG}	-	-55	+125	°C

*1: When the IC is mounted on 74mm x 74mm four-layer square epoxy board. IC is mounted on a four-layer epoxy board, which terminal bias, and the IC's thermal pad is connected to the epoxy board.

WARNING:

- Semiconductor devices may be permanently damaged by application of stress (including, without limitation, voltage, current or temperature) in excess of absolute maximum ratings. Do not exceed any of these ratings.

Figure 2. Power Dissipation vs. Operation Ambient Temperature

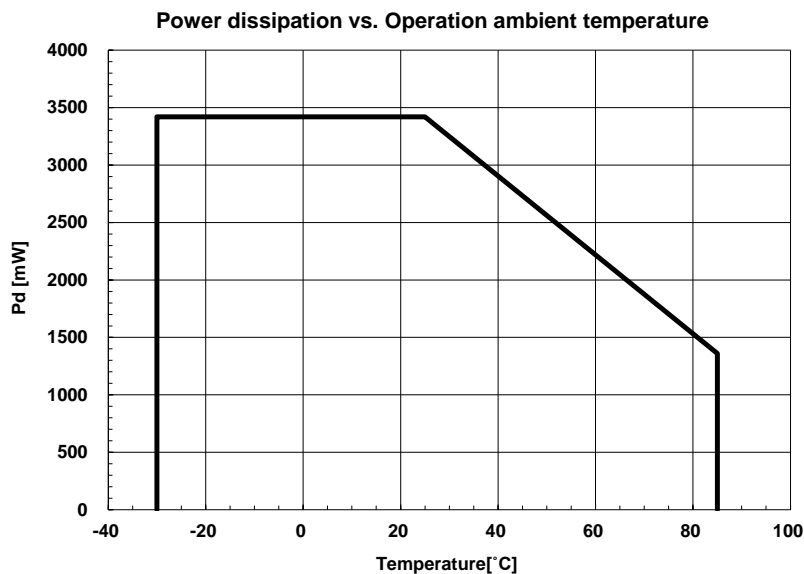

7. Recommended Operating Conditions

Parameter	Symbol	Condition	Value			Unit
			Min	Typ	Max	
1. Reference control block						
Power supply voltage	V _{VCC}	AVCC	2.5	3.3	5.5	V
Output current for reference voltage	I _{REF}	VREF18	-1	-	0	mA
Operating temperature	T _a	-	-30	+25	+85	°C
2. DC/DC channel						
Power supply voltage	V _{VCC}	PVCC1, PVCC2, PVCC3, PVCC4	2.5	3.3	5.5	V
Input voltage	V _{OUT}	IN1, IN2	0	-	AVCC	V
PG input voltage	V _{PG}	PG1, PG2, PG3, PG4	0	-	5.5	V
3. Input block						
Input voltage	V _{CTL} V _{MODE}	CTL1, CTL 2, CTL3, mode CTLMAN	0	-	AVCC	V
4. I ² C communication block						
Power supply voltage	V _{VCC}	DVCC	1.70	-	3.50	V
Input voltage	V _{LOGIC}	SDA, SCL	0	-	DVCC	V

WARNING:

1. The recommended operating conditions are required in order to ensure the normal operation of the semiconductor device. All of the device's electrical characteristics are warranted when the device is operated under these conditions.
2. Any use of semiconductor devices will be under their recommended operating condition.
3. Operation under any conditions other than these conditions may adversely affect reliability of device and could result in device failure.
4. No warranty is made with respect to any use, operating conditions or combinations not represented on this data sheet. If you are considering application under any conditions other than listed herein, please contact sales representatives beforehand.

8. Electrical Characteristics

8.1 Reference Control Block

(AVCC = PVCC1=PVCC2=PVCC3=PVCC4= 3.3V supply,
PGND1=PGND2=PGND3=PGND4=GND = 0V, Ta = +25°C, unless otherwise noted.)

Parameter	Symbol	Condition	Value			Unit
			Min	Typ	Max	
1. Reference voltage [VREF18]						
Output voltage	V _{VREF1}	VREF18 pin = 0mA	1.773	1.800	1.827	V
	V _{VREF2}	AVCC pin = 2.5V to 5.5V VREF18 pin = 0mA	1.768	1.800	1.832	V
	V _{VREF3}	VREF18 pin = 0mA to -1mA	1.768	1.800	1.832	V
2. Under voltage lockout [VCC UVLO]						
Threshold voltage	V _{TH}	AVCC rising	2.156	2.20	2.244	V
Hysteresis width	V _H	-	-	0.20(*1)	-	V
3. Over current protection [OCP]						
Timer	t _{OCP1}	DD1, DD2, DD3, DD4	0.9	1	1.1	ms
4. Thermal shut down [TSD]						
Stop temperature	T _{TSDH}	-	125(*2)	150	-	°C
5. Input block (CTL,mode,CTLMMAIN) [CTL,CTLMMAIN]						
Input voltage	V _{IH}	CTL1, CTL2, CTL3, CTL4 pin CTLMMAIN pin	AVCC ×0.7	-	AVCC	V
Input voltage	V _{IL}	CTL1, CTL2, CTL3, CTL4 pin CTLMMAIN pin	0	-	0.4	V
Input current	I _{CTLH} I _{MODEH}	CTL1, CTL2, CTL3, CTL4 pin = 3.3V CTLMMAIN pin = 3.3V	2.5	3.3	4.7	μA
	I _{CTL} I _{MODEL}	CTL1, CTL2, CTL3, CTL4 pin = 0V CTLMMAIN pin = 0V	-	-	1	μA
Input pull-down resistor	R _P	CTL1, CTL2, CTL3, CTL4 pin CTLMMAIN pin	-	1(*1)	-	MΩ
6. Consumption current (DC/DC converter block)						
Power supply current	I _{VCCS1}	CTL1, CTL2, CTL3, CTL4 pin = 0V CTLMMAIN pin = 0V	-	0	1.0	μA
	I _{VCCS2}	CTL1, CTL2, CTL3, CTL4 pin = 0V CTLMMAIN pin = 3.3V	-	30	45	μA
	I _{VCC}	DD1,DD2,DD3,DD4=ON, All DD are 0mA (operation mode: PFM/PWM mode)	-	450	670	μA
	I _{VCC}	DD1,DD2,DD3,DD4=ON, All DD are 0mA (operation mode: Fixed PWM mode)	-	18	27	mA

*1: This parameter is not be specified. This should be used as a reference to support designing the circuits.

*2: No production tested, ensure by design.

8.2 DD1

(AVCC = PVCC1=PVCC2=PVCC3=PVCC4= 3.3V supply,
PGND1=PGND2=PGND3=PGND4=GND = 0V. Ta = +25°C, unless otherwise noted.)

Parameter	Symbol	Condition	Value			Unit
			Min	Typ	Max	
1. DC/DC converter block [DD1]						
Output voltage	V _{OUT}	I _{OUT} = -10mA, Output voltage setting: 1.0V	0.988	1.000	1.012	V
Input stability	V _{LINE}	I _{OUT} = -10mA, PVCC1= 2.5V to 5.5V	-5	-	+5	mV
Load stability	V _{LOAD}	I _{OUT} = -1mA to -400mA (Fixed PWM mode)	-10	-	+10	mV
Load stability	V _{LOAD}	I _{OUT} = -1mA to -400mA (PFM/PWM mode)	-10	-	+15	mV
IN1 input impedance	R _{IN}	IN1 = 2.0V	-	190(*1)	-	kΩ
SW PMOS-Tr on resistance	R _{PMOS}	LX1 = -30mA	-	120(*1)	-	mΩ
SW NMOS-Tr on resistance	R _{NMOS}	LX1 = 30mA	-	80(*1)	-	mΩ
SW PMOS-Tr leakage current	I _{LEAK}	LX1 = 0V	-3	-	-	μA
SW NMOS-Tr Leakage current	I _{LEAK}	LX1 = 3.3V	-	-	3	μA
Over current protection value	I _{LIMIT}	L=1.0μH	2400(*2)	-	-	mA
PFM/PWM mode changeover current	I _{PFM}	L=1.0μH	-	100(*1)	-	mA
Discharge resistor	R _{DIS}	-	-	5(*1)	-	kΩ
Soft start time	T _{SS}	Soft start time setting: 1ms	0.9	1	1.1	ms
Switching frequency	f _{OSC}	-	2.7	3.0	3.3	MHz

*1: This parameter is not be specified. This should be used as a reference to support designing the circuits.

*2: No production tested, ensure by design.

8.3 DD2

(AVCC = PVCC1=PVCC2=PVCC3=PVCC4= 3.3V supply,
PGND1=PGND2=PGND3=PGND4=GND = 0V. Ta = +25°C, unless otherwise noted.)

Parameter	Symbol	Condition	Value			Unit
			Min	Typ	Max	
2. DC/DC converter block		[DD2]				
Output voltage	V _{OUT}	I _{OUT} = -10mA, Output voltage setting:1.8V	1.778	1.800	1.822	V
Input stability	V _{LINE}	I _{OUT} = -10mA PVCC2= 2.5V to 5.5V	-5	-	+5	mV
Load stability	V _{LOAD}	I _{OUT} = -1mA to -1200mA (Fixed PWM mode)	-10	-	+10	mV
Load stability	V _{LOAD}	I _{OUT} = -1mA to -1200mA (PFM/PWM mode)	-10	-	+20	mV
IN2 input impedance	R _{IN}	IN2 = 2.0V	-	150(*1)	-	kΩ
SW PMOS-Tr on resistance	R _{PMOS}	LX2 = -30mA	-	190(*1)	-	mΩ
SW NMOS-Tr on resistance	R _{NMOS}	LX2 = 30mA	-	135(*1)	-	mΩ
SW PMOS-Tr leakage current	I _{LEAK}	LX2 = 0V	-3	-	-	μA
SW NMOS-Tr leakage current	I _{LEAK}	LX2 = 3.3V	-	-	3	μA
Over current protection value	I _{LIMIT}	L=1.0μH	1500(*2)	-	-	mA
PFM/PWM mode changeover current	I _{PFM}	L=1.0μH	-	65(*1)	-	mA
Discharge resistor	R _{DIS}	-	-	5(*1)	-	kΩ
Soft start time	T _{SS}	Soft start time setting:1ms	0.9	1	1.1	ms
Switching frequency	f _{OSC}	-	2.7	3.0	3.3	MHz

*1: This parameter is not be specified. This should be used as a reference to support designing the circuits.

*2: No production tested, ensure by design.

8.4 DD3

(AVCC = PVCC1=PVCC2=PVCC3=PVCC4= 3.3V supply,
PGND1=PGND2=PGND3=PGND4=GND = 0V. Ta = +25°C, unless otherwise noted.)

Parameter	Symbol	Condition	Value			Unit
			Min	Typ	Max	
3. DC/DC converter block [DD3]						
Output voltage	V _{OUT}	I _{OUT} = -10mA, Output voltage setting:3.3V	3.241	3.300	3.359	V
Input stability	V _{LINE}	I _{OUT} = -10mA, PVCC3= 2.5V to 5.5V	-5	-	+5	mV
Load stability	V _{LOAD}	I _{OUT} = -1mA to -600mA (Fixed PWM mode)	-10	-	+10	mV
Load stability	V _{LOAD}	I _{OUT} = -1mA to -600mA (PFM/PWM mode)	-10	-	+15	mV
VO3 impedance	R _{VO3}	VO3= 2.0V	-	550(*1)	-	kΩ
SW PMOS-Tr on resistance	R _{PMOS}	LX3-1 = -30mA	-	115(*1)	-	mΩ
SW NMOS-Tr on resistance	R _{NMOS}	LX3-1 = 30mA	-	140(*1)	-	mΩ
SW PMOS-Tr on resistance	R _{PMOS}	LX3-2 = -30mA	-	155(*1)	-	mΩ
SW NMOS-Tr on resistance	R _{NMOS}	LX3-2 = 30mA	-	220(*1)	-	mΩ
SW PMOS-Tr leakage current	I _{LEAK}	LX3-1 = 0V	-3	-	-	μA
SW NMOS-Tr leakage current	I _{LEAK}	LX3-1 = 3.3V	-	-	1	μA
SW PMOS-Tr leakage current	I _{LEAK}	LX3-2 = 0V	-3	-	-	μA
SW NMOS-Tr leakage current	I _{LEAK}	LX3-2 = 3.3V	-	-	1	μA
Over current protection value	I _{LIMIT}	L=1.0μH	1000(*2)	-	-	mA
PFM/PWM mode changeover current	I _{PFM}	L=1.0μH	-	200(*1)	-	mA
Discharge resistor	R _{DIS}	-	-	5(*1)	-	kΩ
Soft start time	T _{SS}	Soft start time setting:1ms	0.9	1	1.1	ms
Switching frequency	f _{OSC}	-	2.7	3.0	3.3	MHz

*1: This parameter is not be specified. This should be used as a reference to support designing the circuits.

*2: No production tested, ensure by design.

8.5 DD4

(AVCC = PVCC1=PVCC2=PVCC3=PVCC4= 3.3V supply,
PGND1=PGND2=PGND3=PGND4=GND = 0V. Ta = +25°C, unless otherwise noted.)

Parameter	Symbol	Condition	Value			Unit
			Min	Typ	Max	
4. DC/DC converter block [DD4]						
Output voltage	V _{OUT}	I _{OUT} = -10mA, Output voltage setting: 1.0V	0.988	1.000	1.012	V
Input stability	V _{LINE}	I _{OUT} = -10mA, PVCC4 = 2.5V to 5.5V	-5	-	+5	mV
Load stability	V _{LOAD}	I _{OUT} = -1mA to -400mA (Fixed PWM mode)	-10	-	+10	mV
Load stability	V _{LOAD}	I _{OUT} = -1mA to -400mA (PFM/PWM mode)	-10	-	+15	mV
IN4 input impedance	R _{IN}	IN4 = 2.0V	-	190(*1)	-	kΩ
SW PMOS-Tr on resistance	R _{PMOS}	LX4 = -30mA	-	120(*1)	-	mΩ
SW NMOS-Tr on resistance	R _{NMOS}	LX4 = 30mA	-	80(*1)	-	mΩ
SW PMOS-Tr leakage current	I _{LEAK}	LX4 = 0V	-3	-	-	μA
SW NMOS-Tr Leakage current	I _{LEAK}	LX4 = 3.3V	-	-	3	μA
Over current protection value	I _{LIMIT}	L=1.0μH	2300(*2)	-	-	mA
PFM/PWM mode changeover current	I _{PFM}	L=1.0μH	-	75(*1)	-	mA
Discharge resistor	R _{DIS}	-	-	5(*1)	-	kΩ
Soft start time	T _{SS}	Soft start time setting: 1ms	0.9	1	1.1	ms
Switching frequency	f _{OSC}	-	2.7	3.0	3.3	MHz

*1: This parameter is not be specified. This should be used as a reference to support designing the circuits.

*2: No production tested, ensure by design.

8.6 Digital Block

(AVCC = PVCC1=PVCC2=PVCC3=PVCC4= 3.3V supply,
PGND1=PGND2=PGND3=PGND4=GND = 0V. Ta = +25°C, unless otherwise noted.)

Parameter	Symbol	Condition	Value			Unit
			Min	Typ	Max	
1. Power Good block [Power Good]						
Output voltage	V _{OL}	PG1, PG2, PG3, PG4 I _{OL} = 1mA	-	-	0.4	V
Output current	I _{OL}	PG1, PG2, PG3, PG4	1	-	-	mA
Low voltage detection	V _{TH}	IN1, IN2, IN4 = falling VO3 = falling	-	V _o × 0.90 (*1)	-	V
Power on detection	V _{TH}	IN1, IN2, IN4 = rising VO3 = rising	-	V _o × 0.93 (*1)	-	V
2. I ² C block [I ² C]						
Input voltage	V _{IH}	SCL, SDA	DVCC ×0.7	-	DVCC	V
	V _{IL}	SCL, SDA	0	-	DVCC ×0.3	V
Input current	I _{IH}	SCL, SDA DVCC = 3.3V	-	-	10	μA
	I _{IL}	SCL, SDA DVCC = 3.3V	-10	-	-	μA
Output voltage	V _{OL}	SDA I _{OL} = 3mA	-	-	0.4	V
Output current	I _{OL}	SDA	3	-	-	mA

*1: This parameter is not be specified. This should be used as a reference to support designing the circuits.

9. Operation Mode List

Table 1. Operation Mode List

	Mode	Stand-by	Stand-by2	Normal	Error Detection
CTL signal	CTLMAIN (external)	L	H	H	H
	CTL1 (external/I ² C)	L	L	H/L(*1)	X
	CTL2 (external/I ² C)	L	L	H/L(*1)	X
	CTL3 (external/I ² C)	L	L	H/L(*1)	X
	CTL4 (external/I ² C)	L	L	H/L(*1)	X
Operation Block	Reference	OFF	ON	ON	ON
	Digital	OFF	ON	ON	ON
	DD1	OFF	OFF	ON/OFF	OFF
	DD2	OFF	OFF	ON/OFF	OFF
	DD3	OFF	OFF	ON/OFF	OFF
I ² C communication	I ² C communication	disable	enable	enable	enable
	Thermal shut down (TSD)	Not available	Not available	available	(*2)
Protection operating	Over current protection(OCP)	Not available	Not available	available	(*2)

*1: normal mode means that CTLMAIN pin is "H" level and each DD CTL pin is "H" level

*2: This state is after each err detection. Error state will release, when the power supply voltage or CTLMAIN pin will turn off and on.

Priority of the External CTL Pin and I²C Communication

CTLMAIN (External)	CTL1, CTL2, CTL3, CTL4 (External)	30h Resistor (I ² C)	Relevant Channel
H	H	1	ON
H	H	0	ON
H	L	1	ON
H	L	0	OFF
L	X	disable	OFF

Notes:

- The I²C communication is valid after the reference control block and digital block activation setting the external CTLMAIN pin to "H" level.
- Please attention below note about ON/OFF control of DD1, DD2, DD3, DD4 by I²C communication. When each DD control is turned off by I²C communication and external CTL pin remains "H" level, DCDC converter keep operating.

10. State Transition Diagram

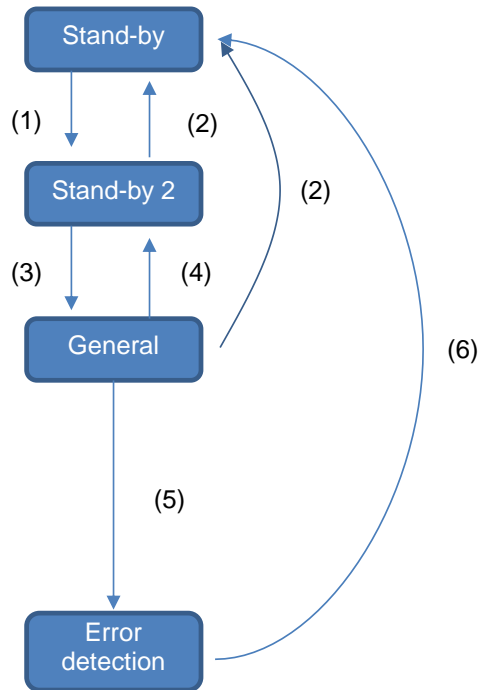

- (1) External CTLMAIN pin is "H" level.
- (2) External CTLMAIN pin is "L" level.
- (3) External CTL pin or I²C communication "relevant CH_ON"
- (4) External CTL pin or I²C communication "relevant CH_OFF"
- (5) Error detection (TSD, OCP 1ms continuation)
- (6) Turning on the power supply again (equal to or less than uvlo_vcc rest voltage) or setting CTLMAIN to "L" level

11. Turning ON and OFF Sequence (AVCC=CTLMAIN, CTL1, CTL2, CTL3, CTL4)

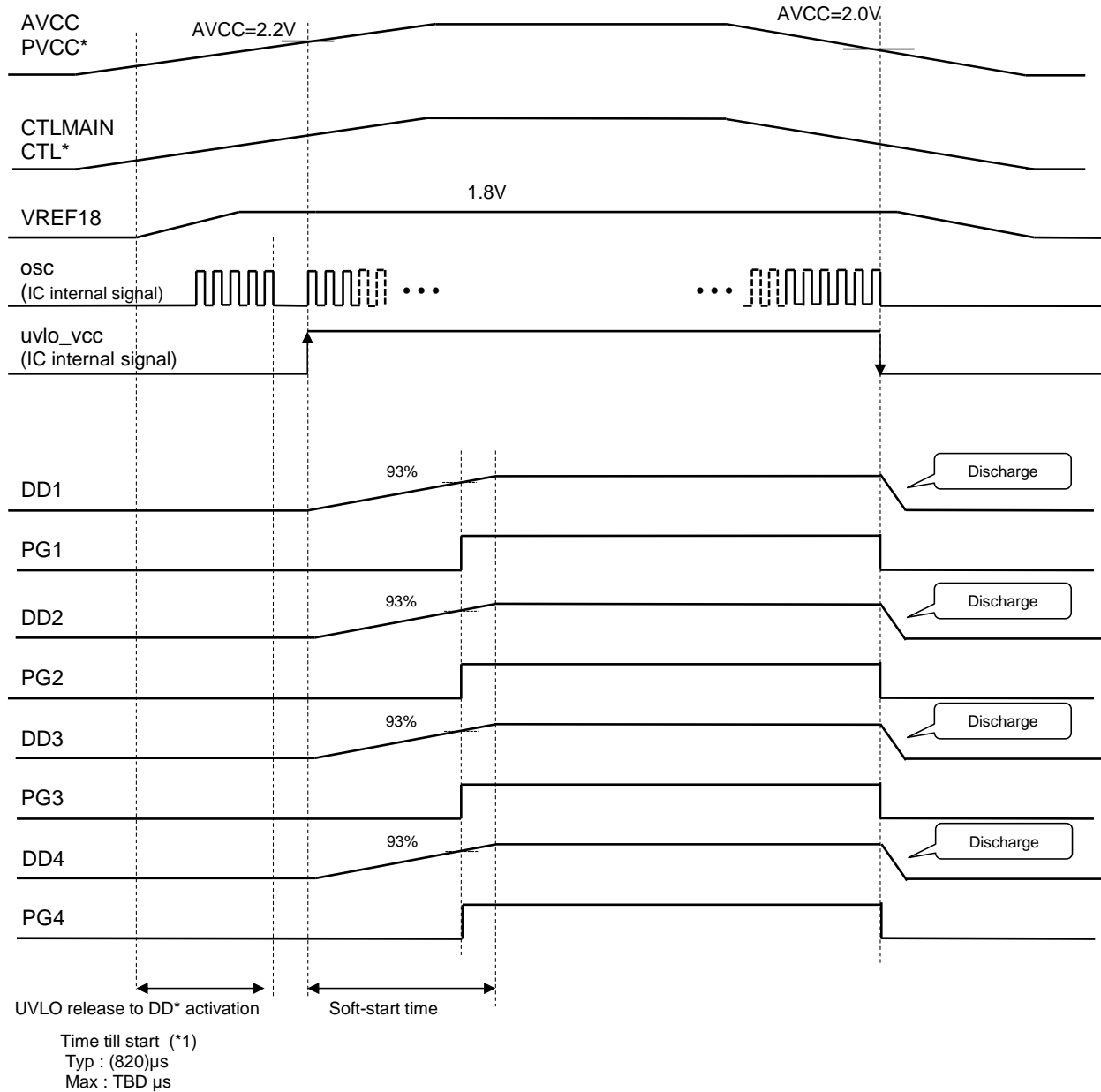

*1: PVCC1, PVCC2, PVCC3, PVCC4

*2: CTL1, CTL2, CTL3, CTL4

*3: DD1, DD2, DD3, DD4

*4: VREF18 activations depend on the VREF18 pin capacitance.
 Time in the sequence figure above is applied for the following condition.
 VREF18 pin capacitance: 1.0μF

12. Turning ON and OFF Sequence (AVCC → CTLMAIN → CTL1 → CTL2 → CTL3 → CTL4)

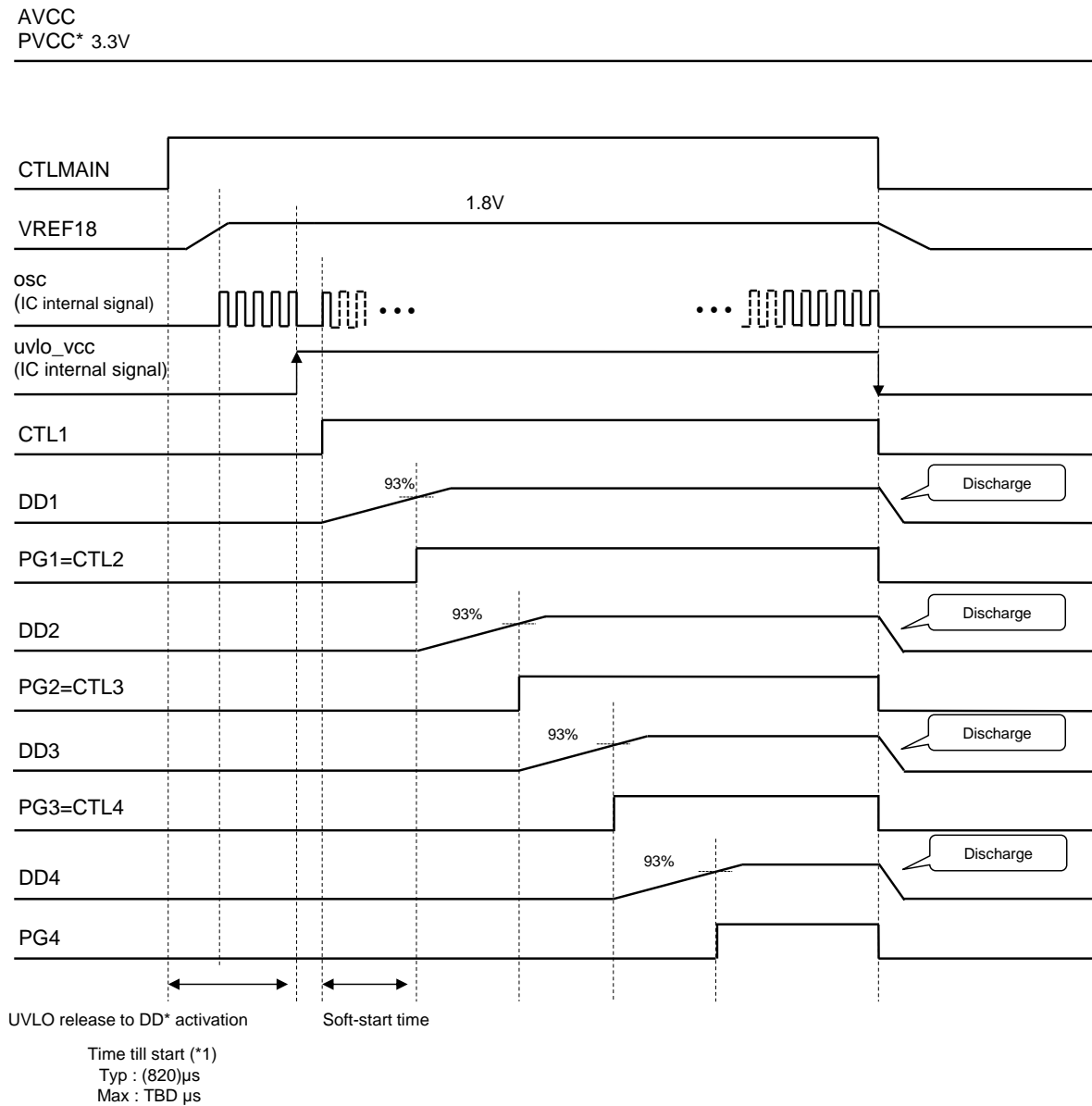

*1: PVCC1, PVCC2, PVCC3, PVCC4

*2: DD1, DD2, DD3, DD4

*3: VREF18 activations depend on the VREF18 pin capacitance.
Time in the sequence figure above is applied for the following condition.
VREF18 pin capacitance: 1.0µF

13. Turning ON and OFF Sequence (AVCC→CTLMAIN→I²C)

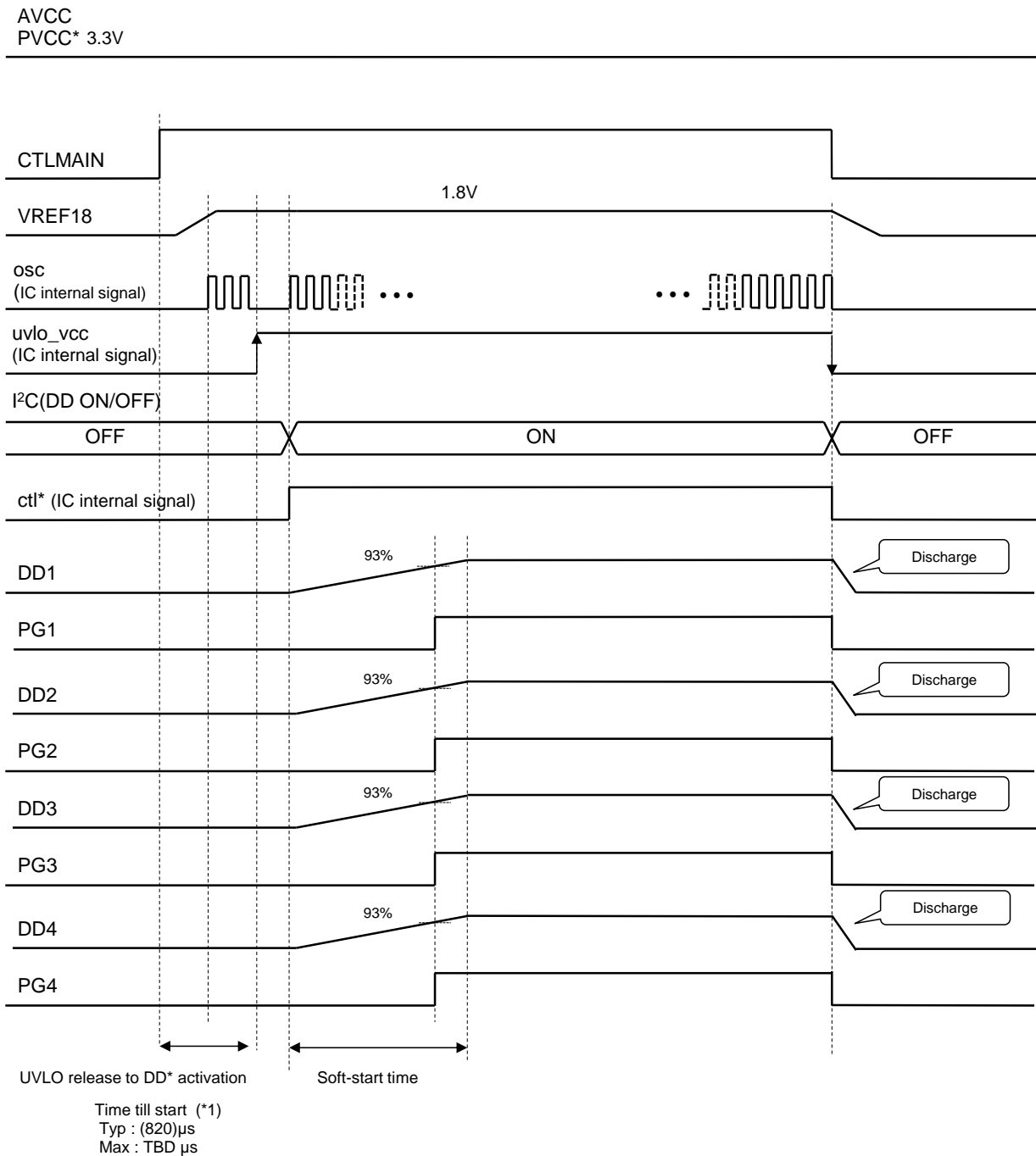

*1: PVCC1, PVCC2, PVCC3, PVCC4

*2: CTL1, CTL2, CTL3

*3: DD1, DD2, DD3

*4: VREF18 activations depend on the VREF18 pin capacitance.

Time in the sequence figure above is applied for the following condition.

VREF18 pin capacitance: 1.0µF

14. CTL Pin Threshold Voltage

The input circuit structure for the CTL(*1) pin is the Schmitt trigger style, and the threshold voltage shows the hysteresis characteristics when CTL(*1) OFF to ON and ON to OFF.

(See "CTL (*1) Pin Equivalent Circuit Diagram" below.)

Also, the threshold voltage level depends on the VCC pin voltage.

Moreover, make sure to input either the "H" level ($>V_{CC} \times 0.7V$) or "L" level ($<0.4V$) to the CTL(*1)pin when in use.

Figure 3. CTL (*1) Pin Equivalent Circuit Diagram

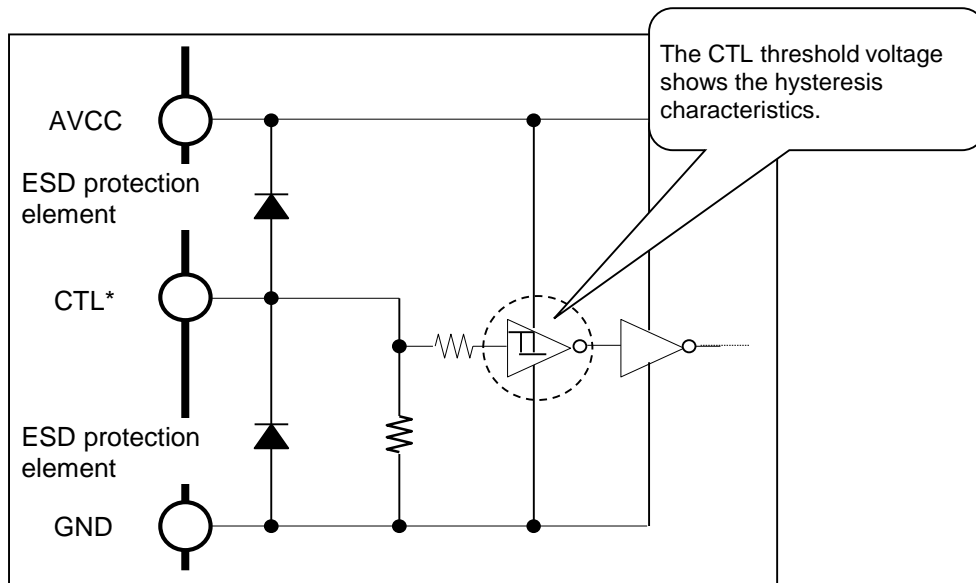

*1: CTLMAN, CTL1, CTL2, CTL3, CTL4

15. Protection Operation Sequence

Over Current Protection (DD channel)

The DD channel monitors the peak current of FET at any time during the operation. When the DD output becomes the over current state, the output voltage is decreased. Afterward, the timer operation is performed and the output stops after about 1ms progress.

When one of each DD channel stops operation by over current protection, all DD channels stop operation.

Thermal Shut Down

If the temperature at the junction part reaches +150°C, the thermal shutdown protection circuit turns all channels off.

Error Detection Sequence

Figure 4. Error Detection Sequence

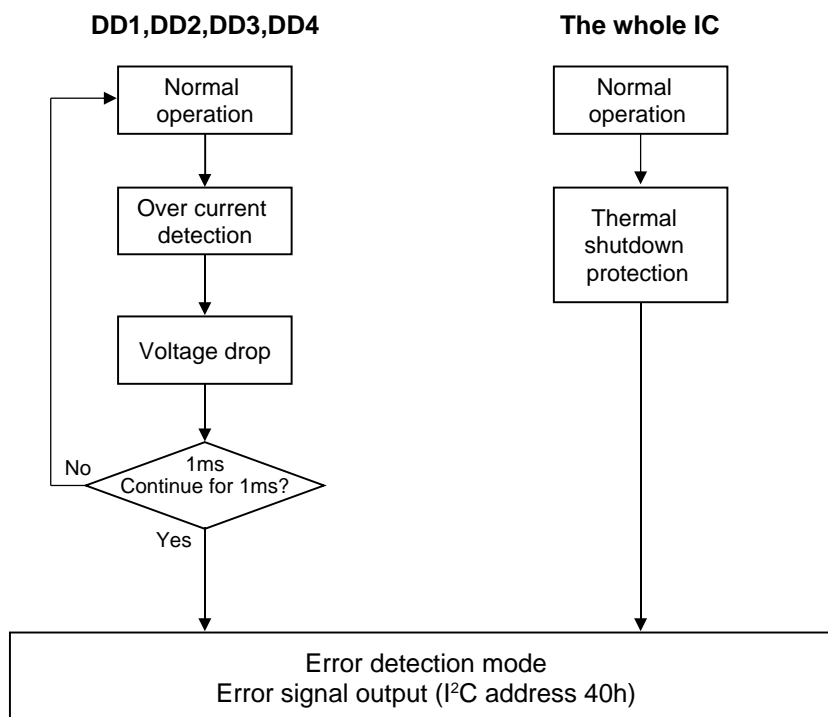

Error Detection Mode Release

It is necessary to turn the power supply turning on again, or to turn CTLMAIN turning on again to release the error detection mode.

16. Operation Condition, Stop Circuit and Release Condition for Protection Circuit

Channel	Operation Whilst Under Protection	Over Current Protection (OCP)	Under Voltage Lockout Protection (UVLO)	Thermal Shutdown Protection (TSD)
DD1,DD2,DD3, DD4	Discharge	<p>Operating condition: After about 1ms progress in the over current condition</p> <p>Process during protection operation: DD1, DD2, DD3, DD4 stop</p> <p>Recovery condition: (1) Power supply reasserted (2) CTLMAIN reasserted</p>	<p>Operating condition: Input voltage drop</p> <p>Process during protection operation: DD1, DD2, DD3, DD4 stop</p> <p>Recovery condition: Input voltage rise</p> <p>UVLO operates only when CTLMAIN is "H" (at VREF18 output).</p>	<p>Operating condition: Chip temperature increment</p> <p>Process during protection operation: DD1, DD2, DD3, DD4 stop</p> <p>Recovery condition: (1) Power supply reasserted (2) CTLMAIN reasserted</p> <p>Only when CTLMAIN is in the "H" state and CTL(*1) is in the "H" state, or when DD(*2) in operating condition by I²C, will operate.</p>
Error output (address 40h)	-	Write "1" when detecting OCP	No change	Write "1" when detecting TSD

Thermal shutdown protection (TSD) operation during over current protection timer operation

When the thermal shutdown protection (TSD) operated during the over current protection (OCP) timer operation, the thermal shutdown protection has priority.

Operation when releasing under voltage lockout protection (UVLO)

- DD1,DD2,DD3,DD4: Activation following the condition for CTL(*1) pin or I²C

Note:

- When VREF18 decreases at the time of UVLO operation, I²C register is reset, and all DD does OFF. It is necessary to let you do ON by CTL(*1) pin and communication again to let DD have ON."

*1: CTL1, CTL2, CTL3, CTL4

*2: DD1, DD2, DD3, DD4

17. DD Soft Start Operation

The soft-start operation for DD1, DD2, DD3 and DD4 is enabled in order to prevent the rush current during the DD activation. The soft-start time can be controlled by I²C.

About output voltage changing option, soft start time is showed by follow equation.

$$T_{ss} = T_{slp} \times V_{set} / V_{def} \text{ (ms)}$$

T_{ss}: soft start time

T_{slp}: slope coefficient of soft start

V_{set}: output voltage setting

V_{def}: DD1=1.0, DD2=1.8, DD3=3.3, DD4=1.0

Figure 5. DD Soft Start

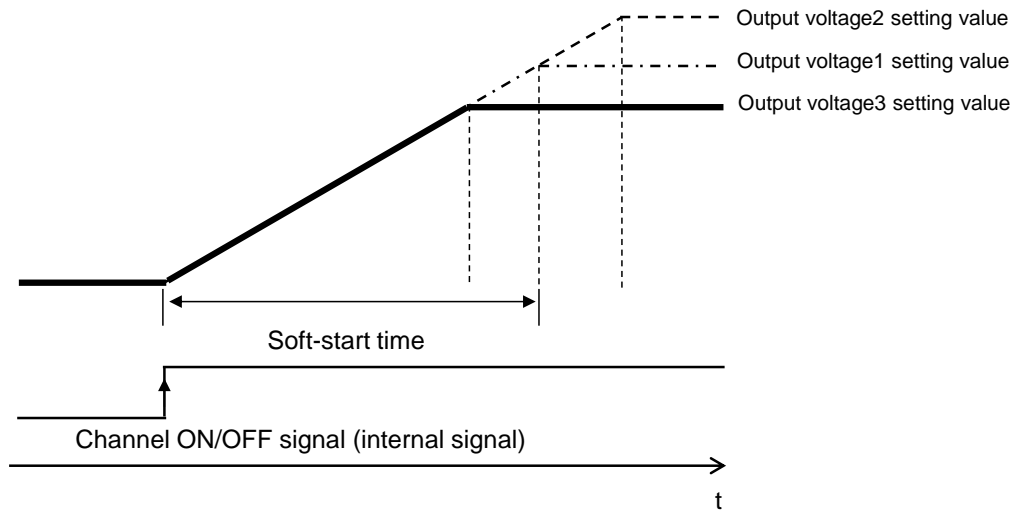

18. Discharge Operation

DD Channel

When executing the DD OFF operation at the channel ON/OFF signal, the DC/DC smooth capacitance charged for each output voltage is discharged using resistor for discharge which is set in the IC and the output voltage is decreased gradually. However, the discharge time changes depending on the DC/DC converter load current.

The discharge time is calculated by the following equation.

Discharge time (time till the output becomes 10% without load)

$$t_{off}(s) \approx 2.3 \times R_{DIS} \times C_{OUT} (F)$$

Note:

- See the table in Electrical Characteristics for the discharge resistor value.

Figure 6. Discharge Function

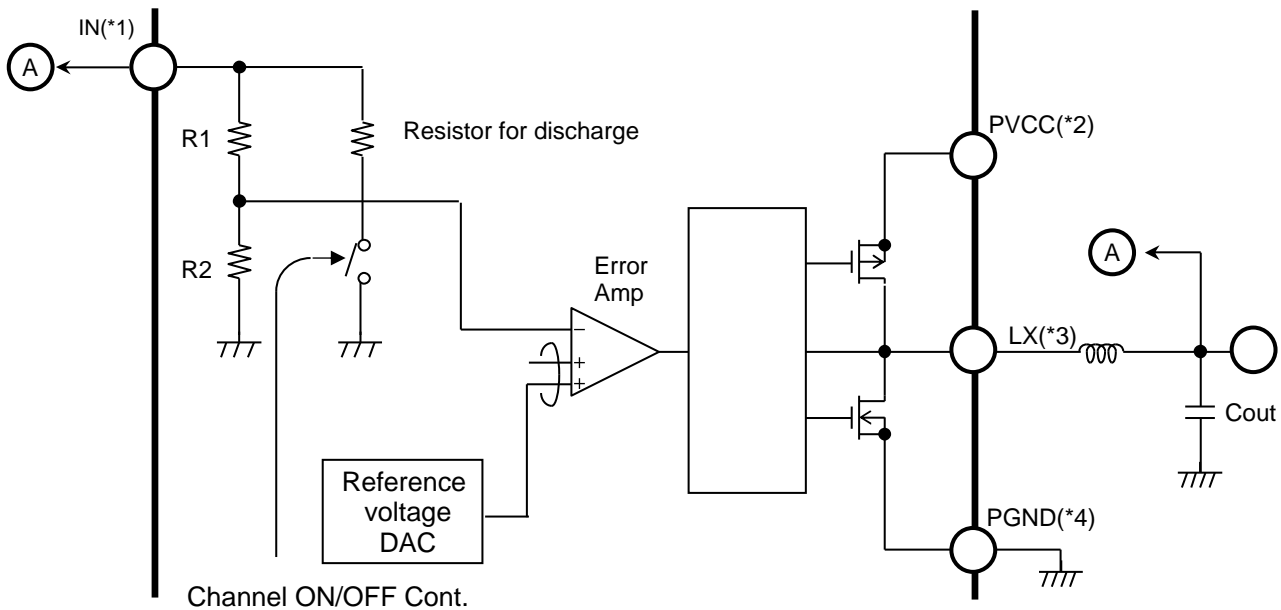

*1: IN1, IN2, IN3, IN4

*2: PVCC1, PVCC2, PVCC3, PVCC4

*3: LX1, LX2, LX3, LX4

*4: PGND1, PGND2, PGND3, PGND4

19. PG Function

The following pins for each channel Power Good output are prepared.

PG1

It is the pin for DD1 Power Good output.

When the output voltage exceeds 93% of the setting value at the DD1 ON mode, "H" is output.

Also, when the output voltage becomes equal or lower than 90% of the setting value after the "H" output, "L" is output. "L" is output at the DD1 OFF mode.

PG2

It is the pin for DD2 Power Good output.

When the output voltage exceeds 93% of the setting value at the DD2 ON mode, "H" is output.

Also, when the output voltage becomes equal or lower than 90% of the setting value after the "H" output, "L" is output. "L" is output at the DD2 OFF mode.

PG3

It is the pin for DD3 Power Good output.

When the output voltage exceeds 93% of the setting value at the DD3 ON mode, "H" is output.

Also, when the output voltage becomes equal or lower than 90% of the setting value after the "H" output, "L" is output. "L" is output at the DD3 OFF mode.

PG4

It is the pin for DD4 Power Good output.

When the output voltage exceeds 93% of the setting value at the DD4 ON mode, "H" is output.

Also, when the output voltage becomes equal or lower than 90% of the setting value after the "H" output, "L" is output. "L" is output at the DD4 OFF mode.

20. I²C Interface

20.1 Structure of I²C Interface

The I²C interface executes the data communication in 1 byte (8-bit) units using two signal lines (bus), a SCL (serial clock line) and a SDA (serial data line).

This bus is connected to multiple devices;

Master: device to generate the clock signal and to control the data transfer (CPU and so on)

Slave: device that an address is specified by a master.

This IC is set as the slave and has no function to be the master.

Each device is defined due to the communication direction as described below.

Transmitter: device to send data to bus

Receiver: device to receive data from bus

The IC has the function both transmitter and receiver.

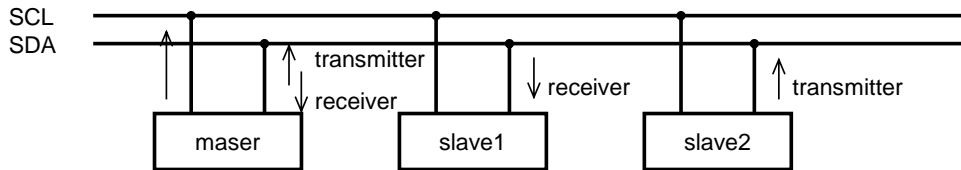

The IC defines the followings;

Write: data is transmitted from master and the IC receives data

Read: The IC transmits data and master receives data.

20.2 Definition of Signal Lines

SCL and SDA are connected to the power supply by the pull-up resistor.

The output circuit is the open Drain output.

When a bus is not used (waiting state), the open "H" is set changing the open Drain to the OFF state.

Note:

- SCL and SDA pins adopt a different ESD protection system from standard I²C specification because of ESD enhancement (See 22.I/O Pin Equivalent Circuit Diagram). When the power supply is in the bus line, do not shut off the power supply for an IC (DVCC).

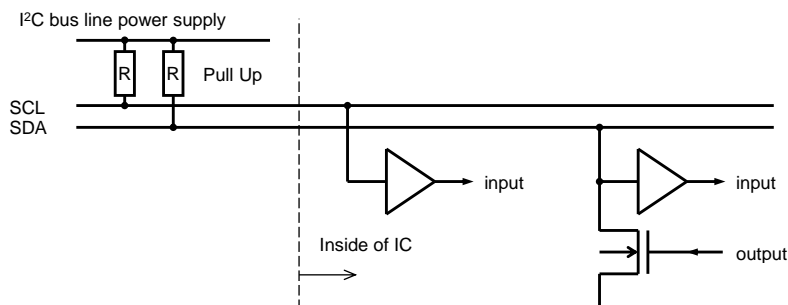

20.3 Validity of Data

Data has the following characteristics;

- Change when SCL is the "L" level
- Valid if the state is kept while SCL is the "H" level.

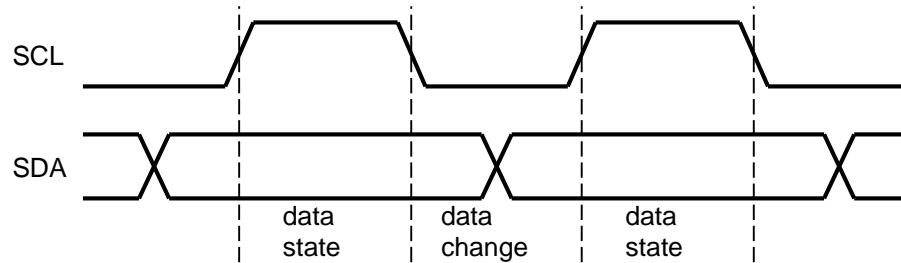

The SDA signal change means the start or stop condition when SCL is the "H" level.

20.4 Definition of Start and Stop Condition

The start and stop conditions are output from the master and shows start and stop of communications to the slave.

- Start: SDA changes from "H" to "L" when SCL is "H".
- Stop: SDA changes from "L" to "H" when SCL is "H".

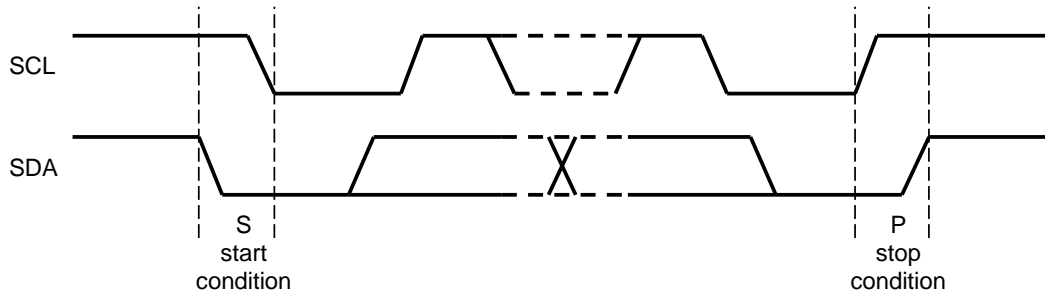

20.5 ACK Signal

This is a signal to confirm the data reception during communication.

The receiver replies the ACK signal to show the data reception to a transmitter every time

1 byte (8-bit) of data is received. The ACK signal is sent in 9clk after sending data 8-bit matching to the SCL signal that the master generates.

- A transmitter keeps SDA output "open H" in SCL9clk.
- A receiver informs the data reception situation to a transmitter outputting the followings in SCL 9 calk ;

When data was received: SDA output "L" (ACK)

When no data was received: SDA output "open H" (NACK)

However, if the master is changed to the receiver, ACK is not replied after the last data reception because the bus keeps open stopping the data transmission to the slave transmitter. In this case, the slave transmitter opens the bus (open H) and is set to the stop condition reception waiting state from the master.

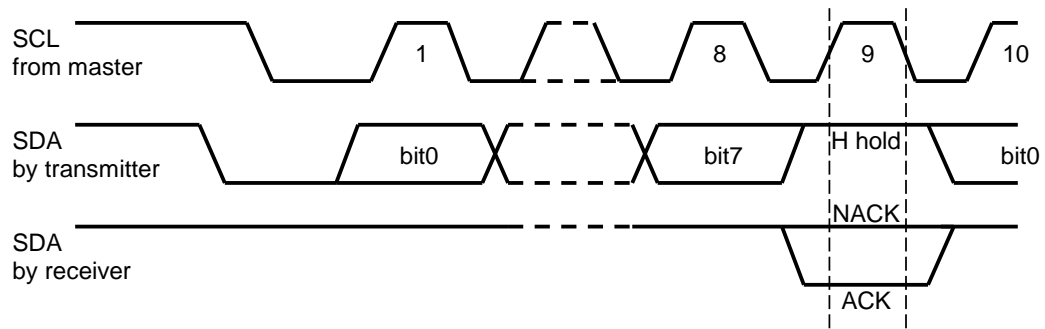

20.6 I²C Interface Input Timing

(Within recommended operating conditions)

Parameter	Symbol	Value				Unit
		SCL=100kHz		SCL=400kHz		
		Min	Max	Min	Max	
SCL clock frequency	f _{SCL}	-	100	-	400	kHz
Start condition hold time	t _{HD:start}	4.0	-	0.6	-	μs
Restart condition setup time	t _{SU:start}	4.7	-	0.6	-	μs
Stop condition setup time	t _{SU:stop}	4.0	-	0.6	-	μs
Stop to Start bus open time	t _{buf}	4.7	-	1.3	-	μs
SCL "L" time	t _{Low}	4.7	-	1.3	-	μs
SCL "H" time	t _{High}	4.0	-	0.6	-	μs
SCL/SDA rising time	t _r	-	1.0	-	0.3	μs
SCL/SDA falling time	t _f	-	0.3	-	0.3	μs
Data hold time	t _{HD:data}	0.0	-	0.0	-	μs
Data setup time	t _{SU:data}	0.25	-	0.10	-	μs
SCL/SDA capacitor load	C _b	-	400	-	400	pF

VIH/VIL level reference

Conform to I²C bus specifications

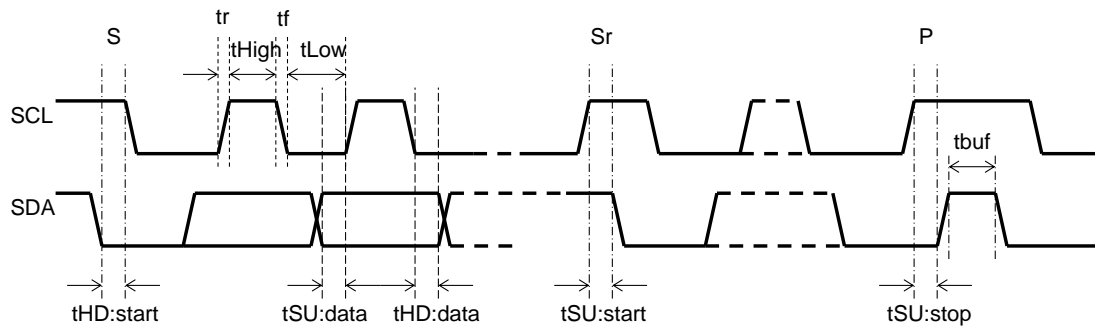

20.7 Slave Address

This is a slave address when communicating with the I²C interface.

The slave address of this IC is set by the first seven bits as shown below.

The eighth bit is called the least significant bit (LSB) and determines the message direction. The bit "0" shows that information will be written from the master to the slave.

The bit "1" shows that the master reads information from the slave.

This does not support the general call address.

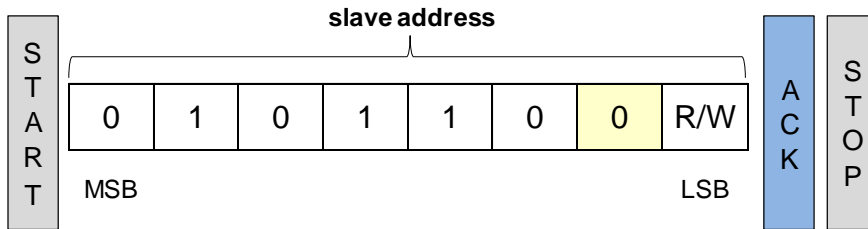

20.8 Bit Structure of Data on I²C Interface

1. Writing Data to Register and Reading Data

The data line is sent/received in the order from the most significant bit (MSB) to the least significant bit (LSB).

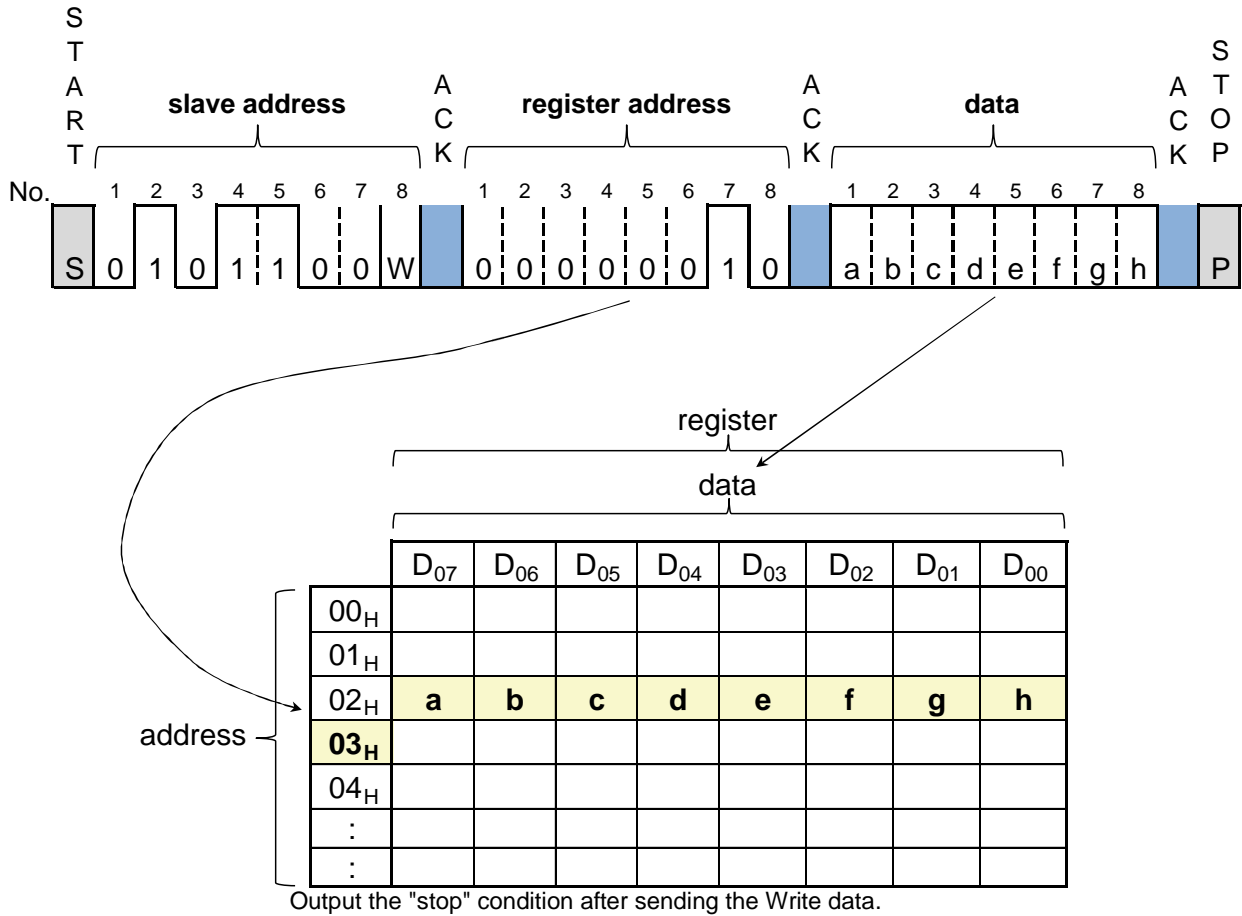

 Signal which a master sends,
  : Signal which this IC sends

2. I²C Interface Data Format

About I²C Communication

1. When a different slave address comes, non-matching ID is informed by not replying ACK after receiving the slave address.
2. All registers write to internal registers in the ACK signal after receiving the 8-bit data of each setting.
3. If a non-existing register address is specified, data is not written to a register.
4. Output the "stop" condition after sending the write data.

<Write (W)>



Write is allowed per one address. (Sequential writing is not allowed.)
Send register address and data as one unit.

⋮ : Signal which a master sends, ⋮ : Signal which this IC sends

<Read(R)>

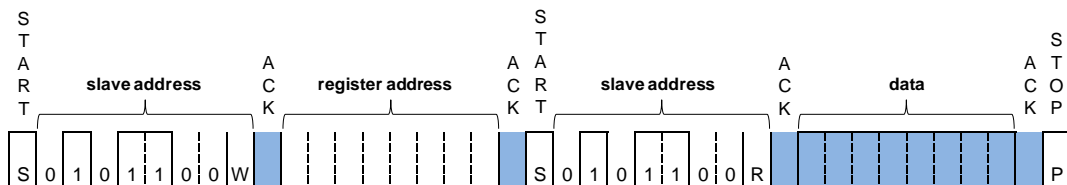

Read is allowed per one address. Be sure to perform read by specifying the register addresses.
(Sequential reading is not allowed.)

⋮ : Signal which a master sends, ⋮ : Signal which this IC sends

21. Structure of I²C Interface and Data

Table 2. Register map

	Address	Data									Writing Timing	Remarks
		d07	d06	d05	d04	d03	d02	d01	d00	Default		
Output voltage	00 _H	0	0	0	D04	D03	D02	D01	D00	0F _H	ACK	DD1 output voltage setting
	01 _H	0	0	0	0	D03	D02	D01	D00	0C _H	ACK	DD2 output voltage setting
	02 _H	0	0	0	0	0	D02	D01	D00	05 _H	ACK	DD3 output voltage setting
	03 _H	0	0	0	D04	D03	D02	D01	D00	0F _H	ACK	DD4 output voltage setting
Soft start	10 _H	0	0	0	0	D03	D02	D01	D00	00 _H	ACK	DD1 soft-start time setting
	11 _H	0	0	0	0	D03	D02	D01	D00	00 _H	ACK	DD2 soft-start time setting
	12 _H	0	0	0	0	D03	D02	D01	D00	00 _H	ACK	DD3 soft-start time setting
	13 _H	0	0	0	0	D03	D02	D01	D00	00 _H	ACK	DD4 soft-start time setting
DD operation mode	20 _H	0	0	0	0	D03	D02	D01	D00	00 _H	ACK	DD operation mode setting "0": Fixed PWM mode, "1":PFM/PWM mode
ON/OFF	30 _H	0	0	0	0	D03	D02	D01	D00	00 _H	ACK	DD output ON/OFF setting "0":Output OFF / "1":Output ON
Error	40 _H	0	0	0	D04	D03	D02	D01	D00	00 _H	-	DD error state monitoring register (read only) "0":Normal / "1":Error detection
PG	50 _H	0	0	0	0	D03	D02	D01	D00	00 _H	-	DD PG state monitoring register (read only) "0":Non-output / "1":output
For test	EX _H	-	-	-	-	-	-	-	-	-	-	Disabled
For test	FX _H	-	-	-	-	-	-	-	-	-	-	Disabled

Note:

- Address FX_H and address EX_H are for test. Do not write/read FX_H and EX_H.

21.1 About DD1, DD4 Output Voltage Setting

- Address 00_H DD1 is allocated as registers for the DC/DC output voltage setting.
Address 03_H DD4 is allocated as registers for the DC/DC output voltage setting.
- The DC/DC output voltage setting of DD1 is controlled by writing data to address 00_H.
The DC/DC output voltage setting of DD4 is controlled by writing data to address 03_H.

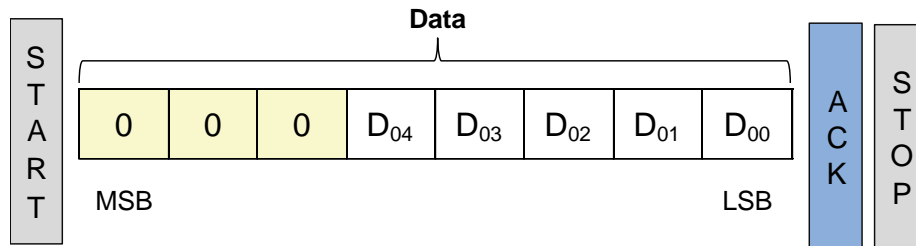

address00_H: For DD1 output voltage setting
 address03_H: For DD4 output voltage setting
 D₀₄ to D₀₀: Set the output voltage

DD1, DD4 Output Voltage Setting Table

Data	Output Voltage (V)	Data	Output Voltage (V)
00 _H	0.700	10 _H	1.020
01 _H	0.720	11 _H	1.040
02 _H	0.740	12 _H	1.060
03 _H	0.760	13 _H	1.080
04 _H	0.780	14 _H	1.100 (*1)
05 _H	0.800	15 _H	1.120
06 _H	0.820	16 _H	1.140
07 _H	0.840	17 _H	1.160
08 _H	0.860	18 _H	1.180
09 _H	0.880	19 _H	1.200 (*1)
0A _H	0.900 (*1)	1A _H	1.220
0B _H	0.920	1B _H	1.240
0C _H	0.940	1C _H	1.260
0D _H	0.960	1D _H	1.280
0E _H	0.980	1E _H	1.300
0F _H	1.000 (*1)	1F _H	1.320

*1: Preset value

21.2 About DD2 Output Voltage Setting

- Address 01_H DD2 is allocated as registers for the DC/DC output voltage setting.
- The DC/DC output voltage setting of DD2 is controlled by writing data to address 01_H.

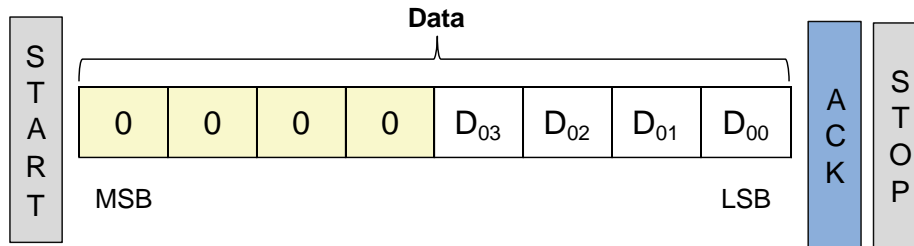

address01_H: For DD2 output voltage setting
 D₀₃ to D₀₀: Set the output voltage

DD2 Output Voltage Setting Table

Data	Output Voltage(V)
00 _H	1.200 (*1)
01 _H	1.250
02 _H	1.300
03 _H	1.350 (*1)
04 _H	1.400
05 _H	1.450
06 _H	1.500 (*1)
07 _H	1.550
08 _H	1.600
09 _H	1.650
0A _H	1.700
0B _H	1.750
0C _H	1.800 (*1)
0D _H	1.850
0E _H	1.900
0F _H	1.950

*1: Preset value

21.3 About DD3 Output Voltage Setting

- Address 02_H DD3 is allocated as registers for the DC/DC output voltage setting.
- The DC/DC output voltage setting of DD3 is controlled by writing data to address 02_H.

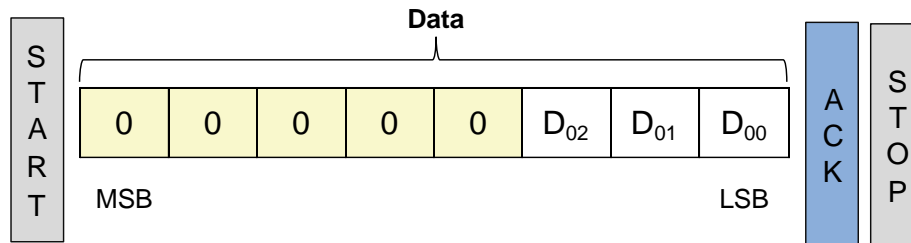

address02_H: For DD3 output voltage setting
 D02 to D00: Set the output voltage

DD3 Output Voltage Setting Table

Data	Output Voltage(V)
00 _H	2.80 (*1)
01 _H	2.90
02 _H	3.00 (*1)
03 _H	3.10
04 _H	3.20
05 _H	3.30 (*1)
06 _H	3.40
07 _H	3.50 (*1)

*1: Preset value

21.4 About Soft Start Time

- Addresses 10_H to 12_H are allocated as registers for the soft start time control.
- The soft start time control is controlled by writing data to addresses 10_H to 12_H.

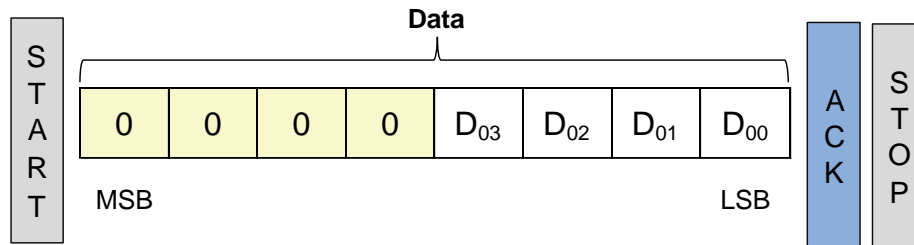

address10_H: For DD1 soft start time setting
 address11_H: For DD2 soft start time setting
 address12_H: For DD3 soft start time setting
 address13_H: For DD4 soft start time setting

D₀₃ to D₀₀: Set the soft start time

$$T_{ss} = T_{slp} \times V_{set} / V_{def} \text{ (ms)}$$

T_{ss}: soft start time

T_{slp}: slope coefficient of soft start: refer to follow table

V_{set}: output voltage setting

V_{def}: DD1=1.0, DD2=1.8, DD3= 3.3, DD4=1.0

Soft Start Time Setting

Data	Tslp	Remarks
00 _H	1.0	DD1,DD2,DD3,DD4 (*1)
01 _H	2.0	
02 _H	3.0	
03 _H	4.0	
04 _H	5.0	
05 _H	6.0	
06 _H	7.0	
07 _H	8.0	
08 _H	9.0	
09 _H	10.0	
0A _H	11.0	
0B _H	12.0	
0C _H	13.0	
0D _H	14.0	
0E _H	15.0	
0F _H	16.0	

*1: Preset value

21.5 DC/DC Operation Mode

- Address 20_H is allocated as a register for the DC/DC operation mode control.
- The DC/DC operation mode is controlled by writing data to address 20_H.

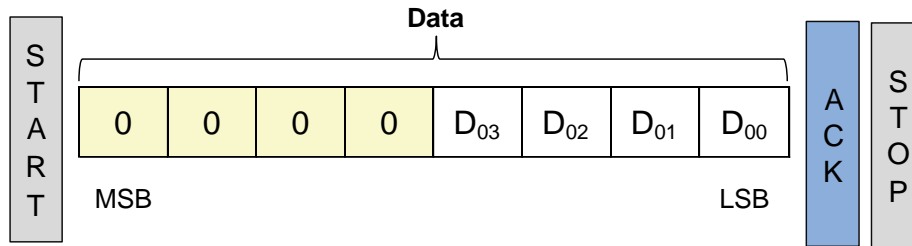

address20_H: For DC/DC operation mode setting
 D₀₁ to D₀₀: Set the DC/DC operation mode

Address	Bit	Description
20 _H	D00	0: DD1 Fixed PWM (*1) 1: DD1 PFM/PWM
20 _H	D01	0: DD2 Fixed PWM (*1) 1: DD2 PFM/PWM
20 _H	D02	0: DD3 Fixed PWM (*1) 1: DD3 PFM/PWM
20 _H	D03	0: DD4 Fixed PWM (*1) 1: DD4 PFM/PWM

*1: Preset value

21.6 ON/OFF for DC/DC

- Address 30_H is allocated as a register for the DC/DC ON/OFF.
- The DC/DC ON/OFF is controlled by writing data to address 30_H.

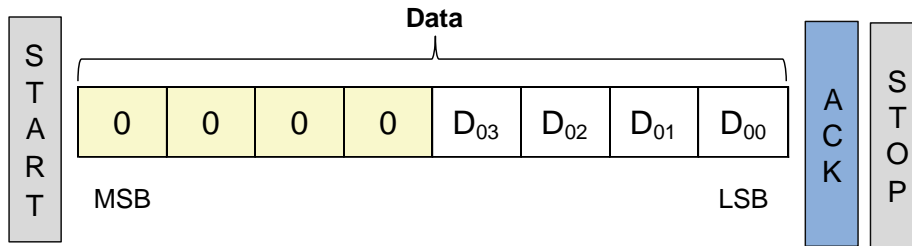

address30_H: For DC/DC ON/OFF
 D₀₂ to D₀₀: Set ON/OFF for DC/DC

Address	Bit	Description
30 _H	D00	0: DD1 output OFF (*1) 1: DD1 output ON
30 _H	D01	0: DD2 output OFF (*1) 1: DD2 output ON
30 _H	D02	0: DD3 output OFF (*1) 1: DD3 output ON
30 _H	D03	0: DD4 output OFF (*1) 1: DD4 output ON

*1: Preset value

21.7 About Error Monitor

- Address 40_H is allocated as error status monitor of each DC/DC output and thermal shut down.
- Address 40_H is read only resistor.

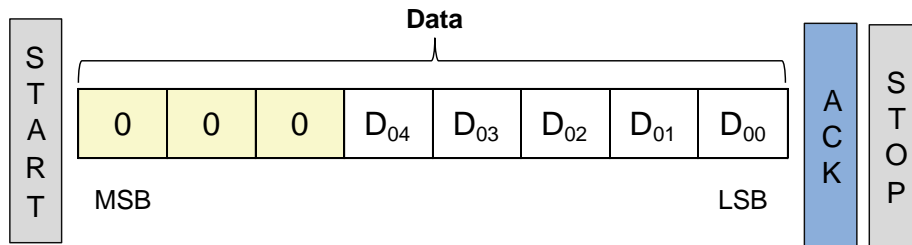

address40_H: For error monitor of each DC/DC output and thermal shut down
 D₀₄ to D₀₀: read only resistor. (Not allowed write resistor)

Address	Bit	Description
40 _H	D00	0: DD1 OCP non detection (*1) 1: DD1 OCP detection
40 _H	D01	0: DD2 OCP non detection (*1) 1: DD2 OCP detection
40 _H	D02	0: DD3 OCP non detection (*1) 1: DD3 OCP detection
40 _H	D03	0: DD4 OCP non detection (*1) 1: DD4 OCP detection
40 _H	D04	0: TSD non detection (*1) 1: TSD detection

*1: Preset value

21.8 About Power Good Monitor

- Address 50_H is allocated as output monitor of each DC/DC output.
- Address 50_H is read only resistor.

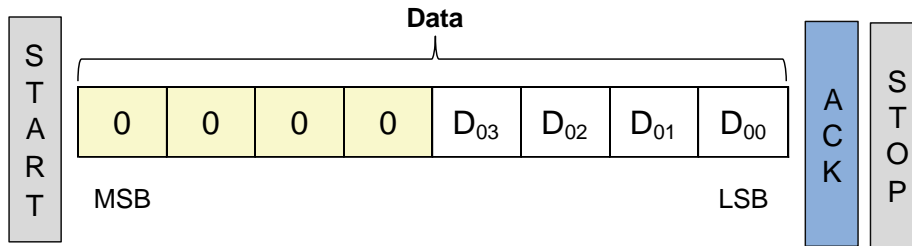

address50_H: For output monitor of each DC/DC output.
 Detection level is over 93% of DCDC output voltage setting.
 D₀₄ to D₀₀: read only resistor. (Not allowed write resistor)

Address	Bit	Description
50 _H	D00	0: DD1 non output (*1) 1: DD1 output
50 _H	D01	0: DD2 non output (*1) 1: DD2 output
50 _H	D02	0: DD3 non output (*1) 1: DD3 output
50 _H	D03	0: DD4 non output (*1) 1: DD4 output

*1: Preset value

22. I/O Pin Equivalent Circuit Diagram

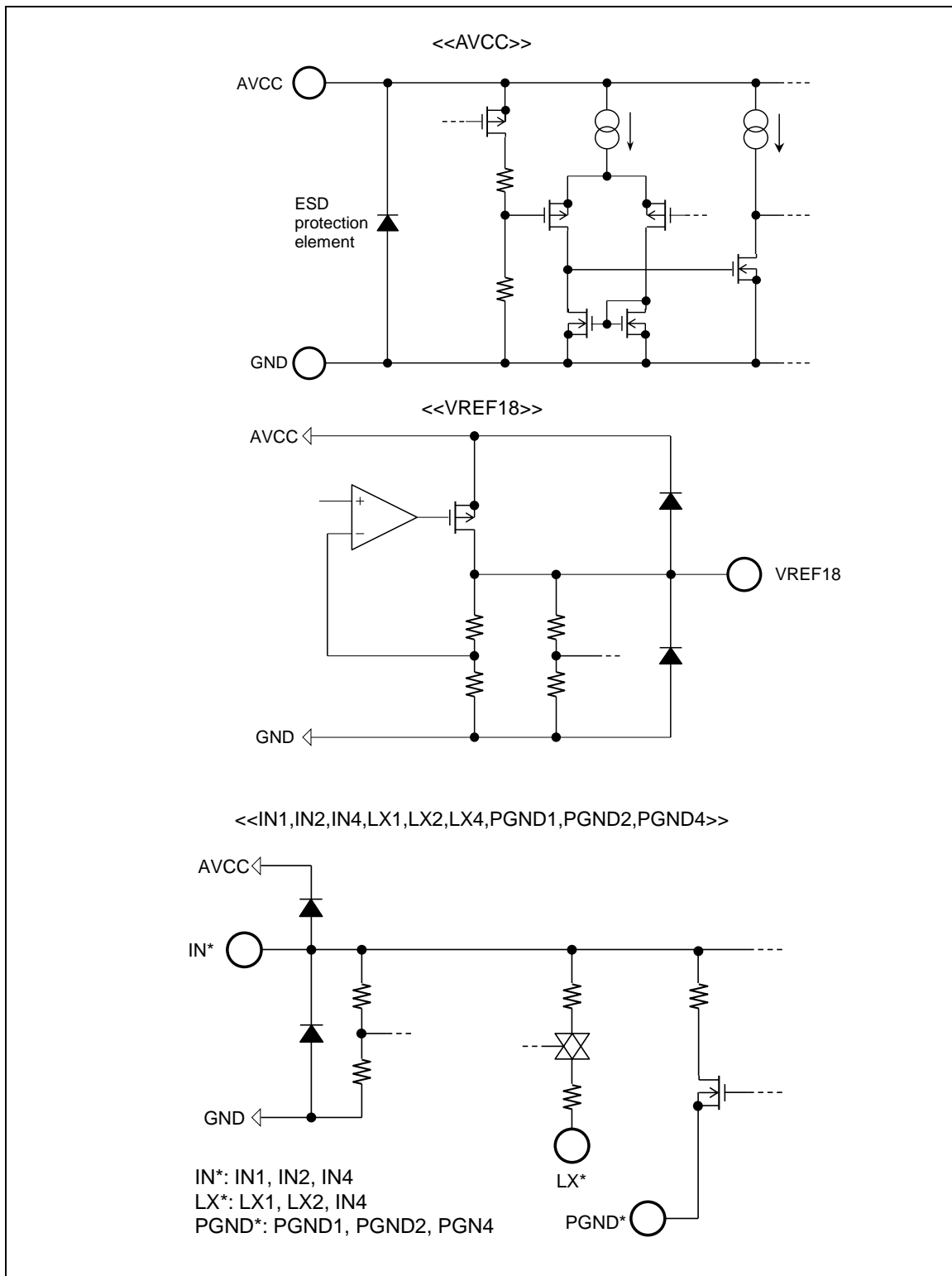

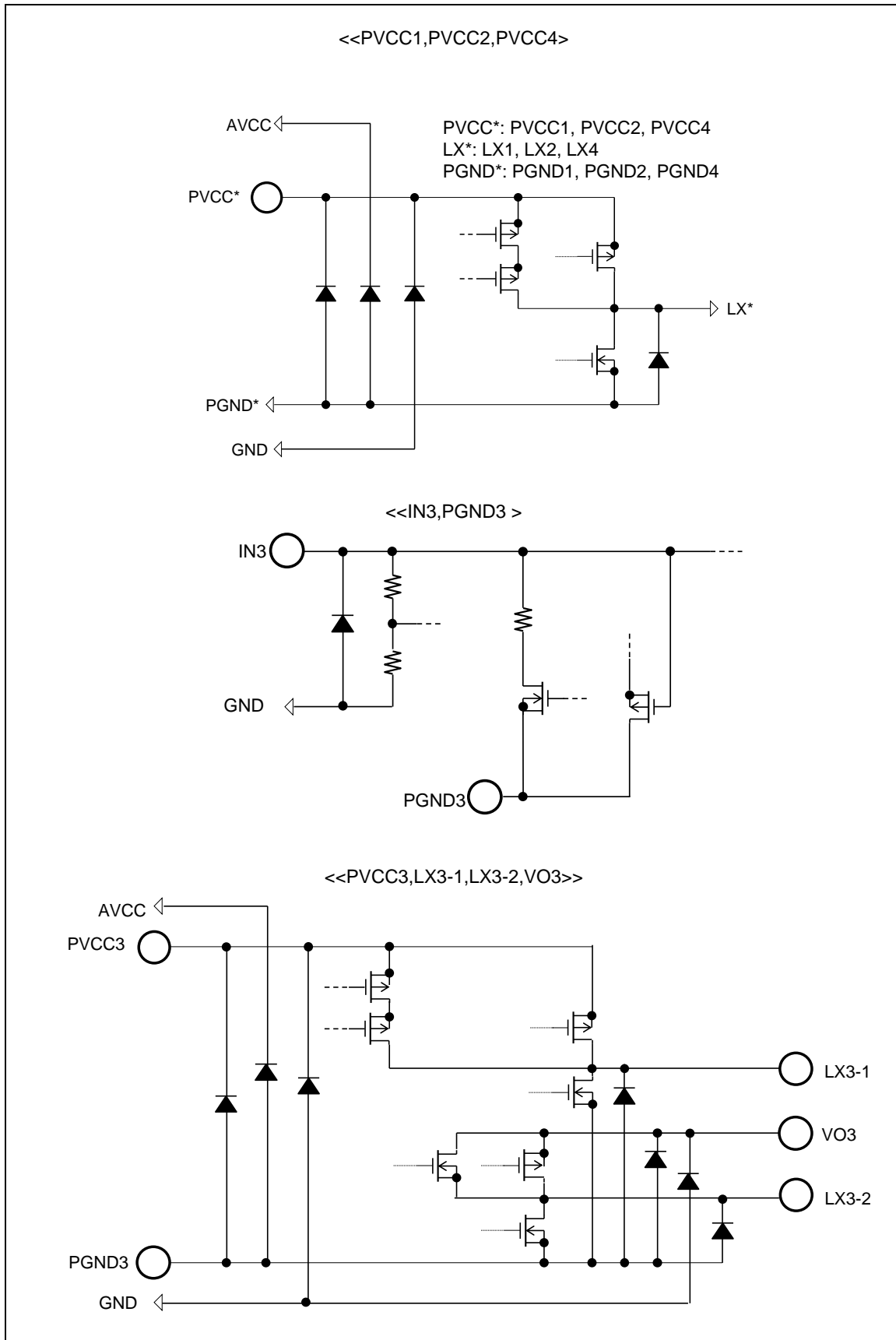

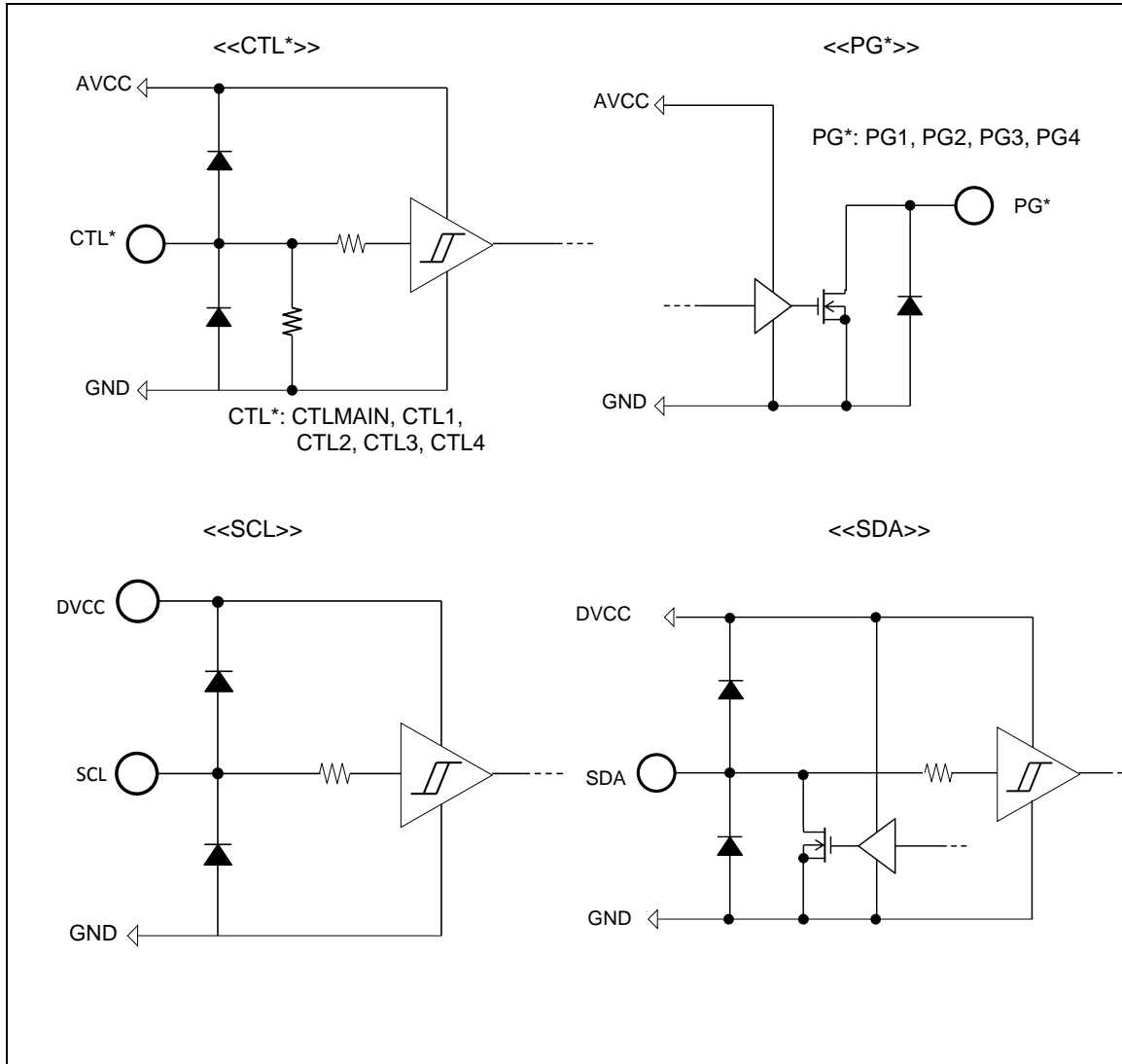

23. Measurement Circuit for Characteristics of General Operation

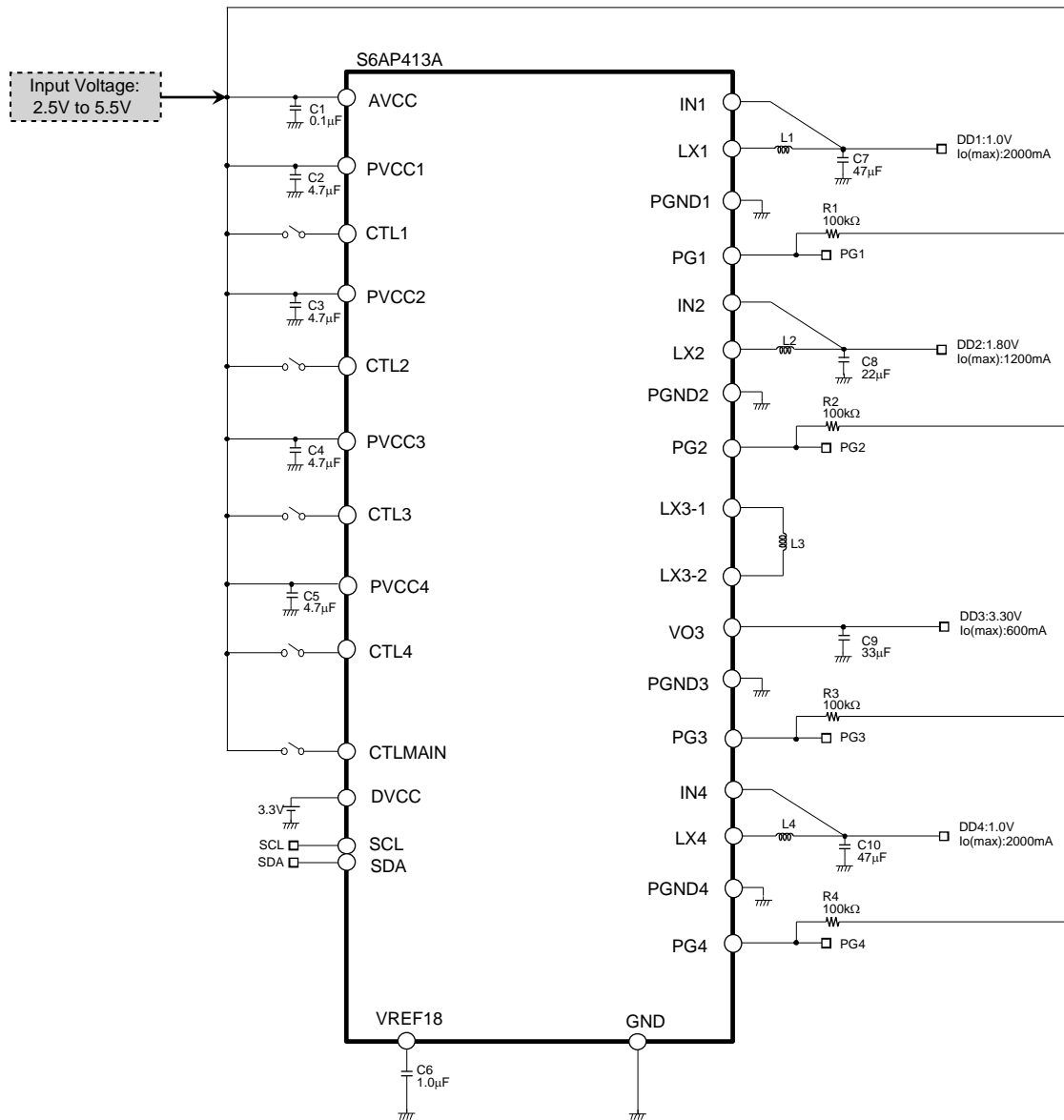

Table 3. Parts list

Symbol	Parts	Part Number	Specifications	Vendor
L1	Inductor	1276AS-H-1R0M	1.0μH	TOKO
L2	Inductor	1276AS-H-1R0M	1.0μH	TOKO
L3	Inductor	1276AS-H-1R0M	1.0μH	TOKO
L4	Inductor	1276AS-H-1R0M	1.0μH	TOKO
C1	Ceramic Capacitor	C1608X5R1H104K	0.1μF	TDK
C2	Ceramic Capacitor	C1608X5R1V475K	4.7μF	TDK
C3	Ceramic Capacitor	C1608X5R1V475K	4.7μF	TDK
C4	Ceramic Capacitor	C1608X5R1V475K	4.7μF	TDK
C5	Ceramic Capacitor	C1608X5R1V475K	4.7μF	TDK
C6	Ceramic Capacitor	C2012X5R1A336M	1.0μF	TDK
C7	Ceramic Capacitor	C2012X5R1A476M	47μF	TDK
C8	Ceramic Capacitor	C1608X5R1A226M	22μF	TDK
C9	Ceramic Capacitor	C2012X5R1A336M	33μF	TDK
C10	Ceramic Capacitor	C2012X5R1A476M	47μF	TDK
R1	Resistor	RR0816P-104-D	100kΩ	SSM
R2	Resistor	RR0816P-104-D	100kΩ	SSM
R3	Resistor	RR0816P-104-D	100kΩ	SSM
R4	Resistor	RR0816P-104-D	100kΩ	SSM

TOKO : TOKO, INC.
 TDK : TDK Corporation
 SSM : SUSUMU CO., LTD.

24. Reference Data

DCDC Convertor Efficiency Data

Inductor and capacitor value refer to section 26.

■ DD1,DD4

Input voltage = 3.3V, Vo = 1.0V setting

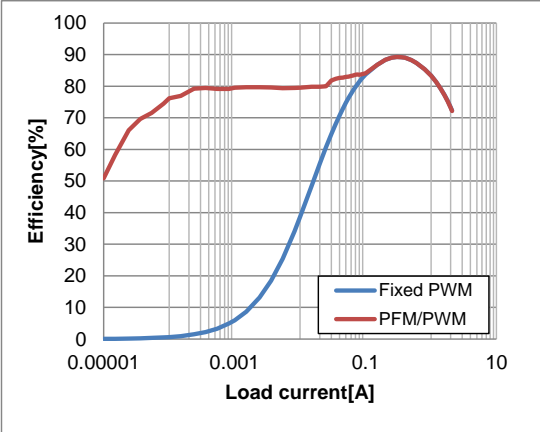

Input voltage = 3.3V, Vo=1.2V setting

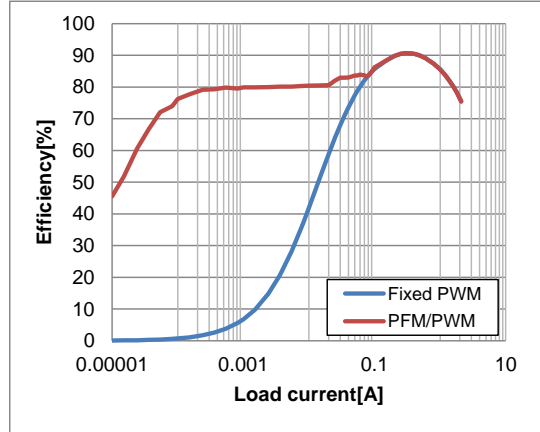

Input voltage = 5.5V, Vo = 1.0V setting

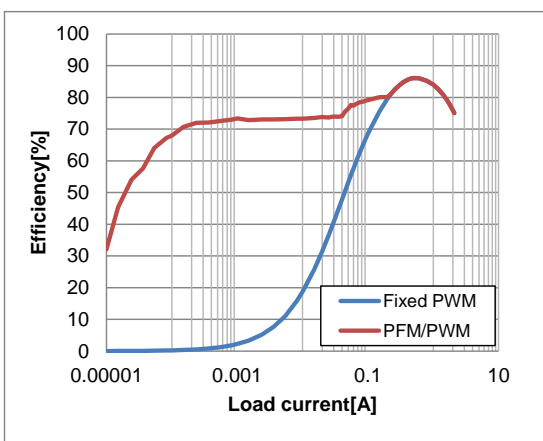

Input voltage = 5.5V, Vo = 1.2V setting

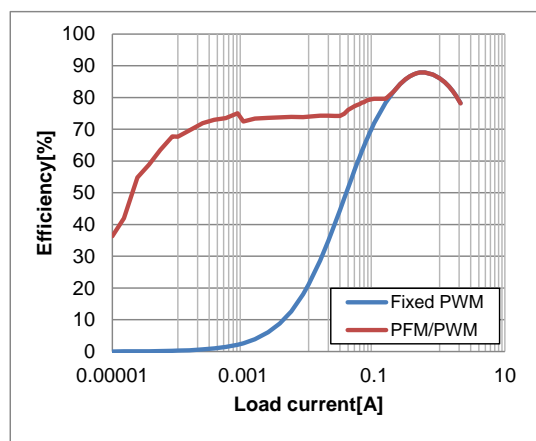

■ DD2

Input Voltage = 3.3V, Vo = 1.5V setting

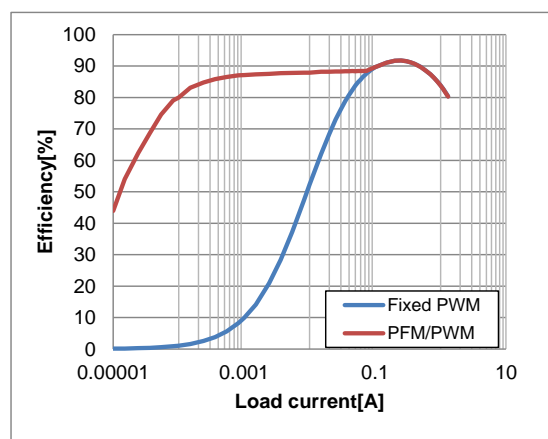

Input voltage = 3.3V, Vo = 1.8V setting

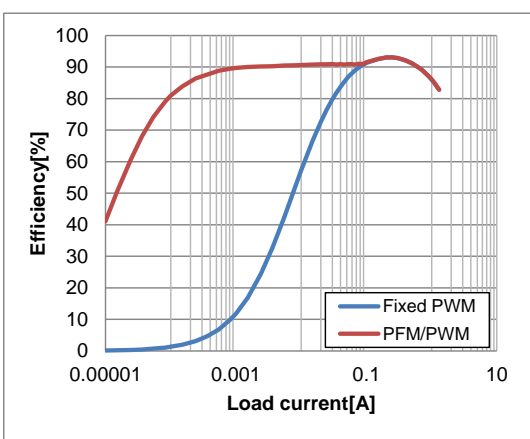

■ DD2

Input voltage = 5.5V, Vo = 1.5V setting

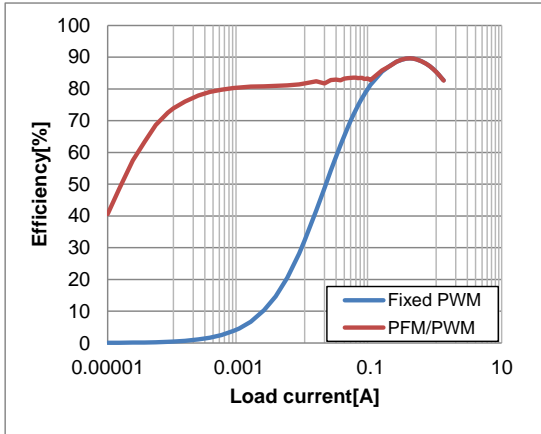

Input Voltage = 5.5V, Vo = 1.8V setting

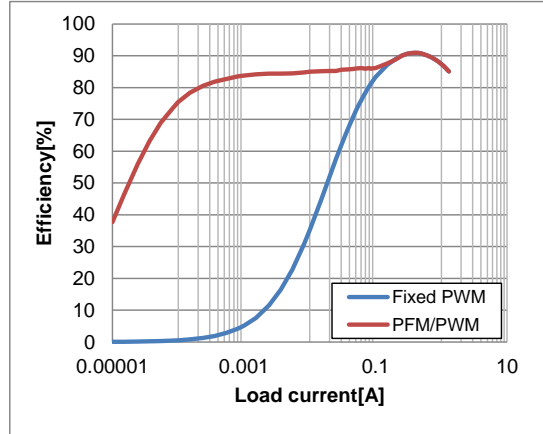

■ DD3

Input voltage = 3.3V, Vo = 3.3V setting

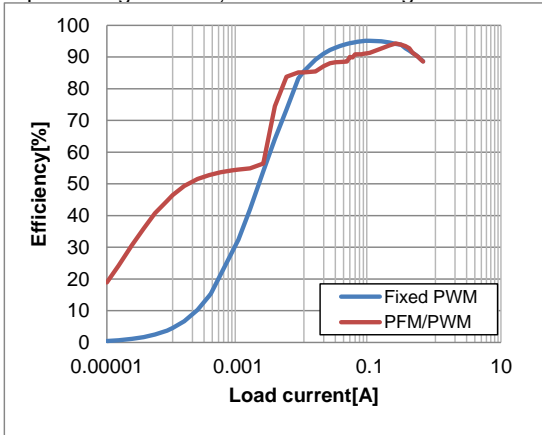

Input Voltage = 5.5V, Vo = 3.3V setting

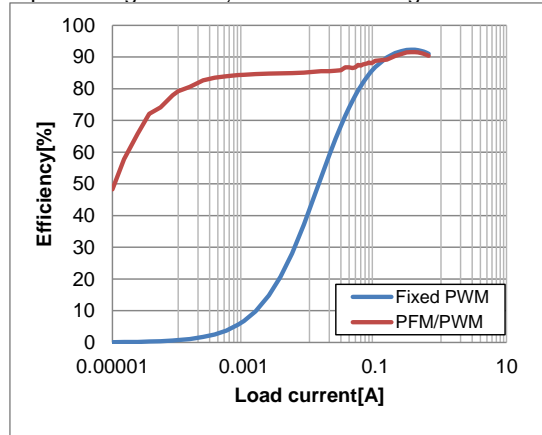

DCDC Converter Regulation Data

■ DD1,DD4

Input voltage = 3.3V, Vo = 1.0V setting

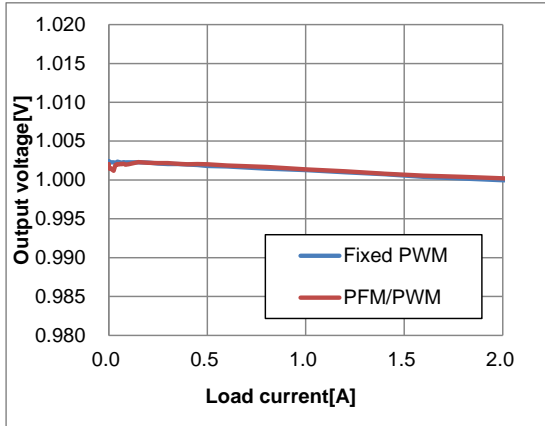

Input voltage = 3.3V, Vo=1.2V setting

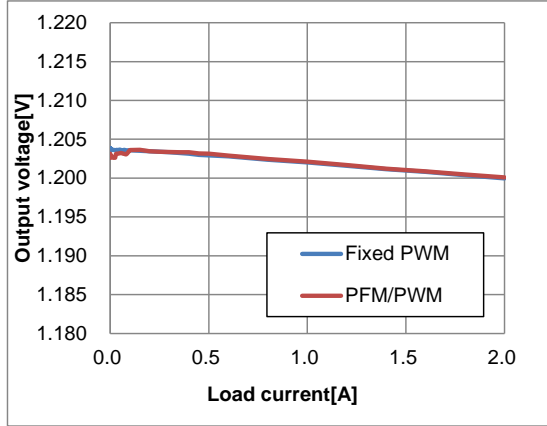

Input voltage = 5.5V, Vo = 1.0V setting

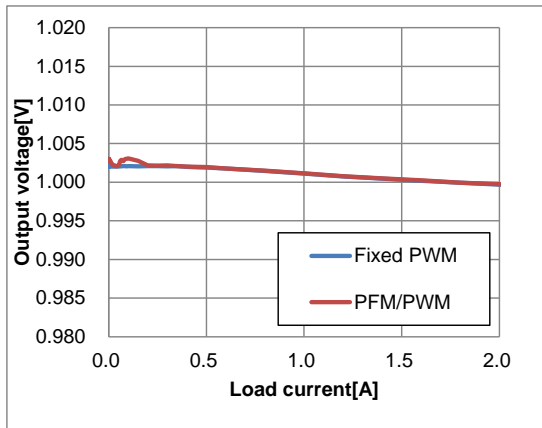

Input voltage = 5.5V, Vo = 1.2V setting

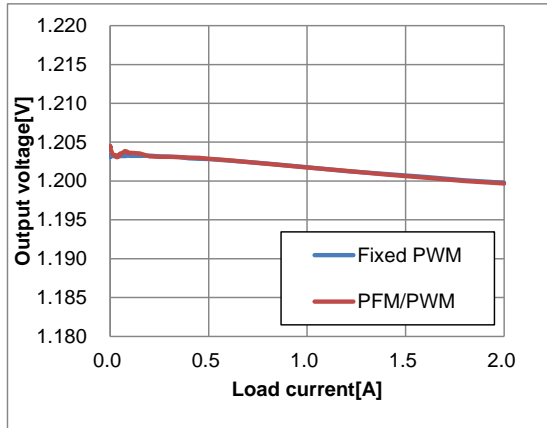

■ DD2

Input Voltage = 3.3V, Vo = 1.5V setting

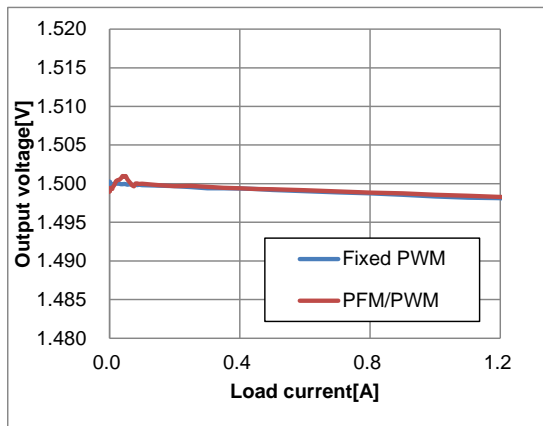

Input voltage = 3.3V, Vo = 1.8V setting

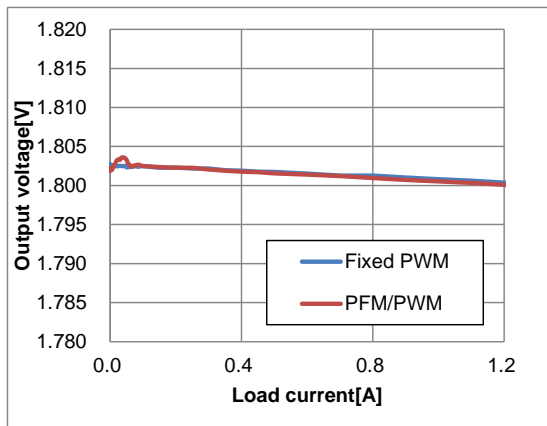

■ DD2

Input voltage = 5.5V, Vo = 1.5V setting

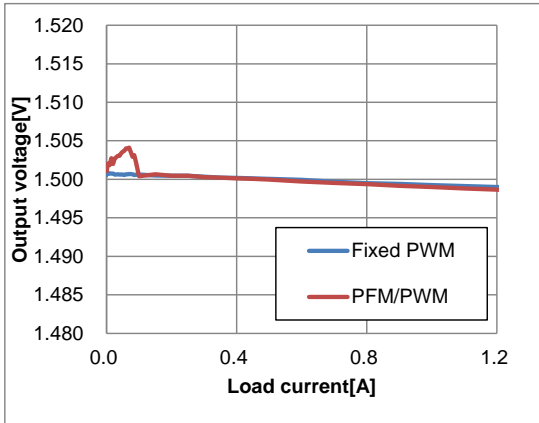

Input Voltage = 5.5V, Vo = 1.8V setting

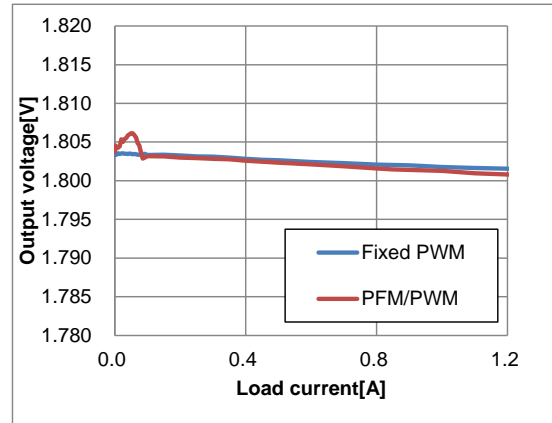

■ DD3

Input voltage = 3.3V, Vo = 3.3V setting

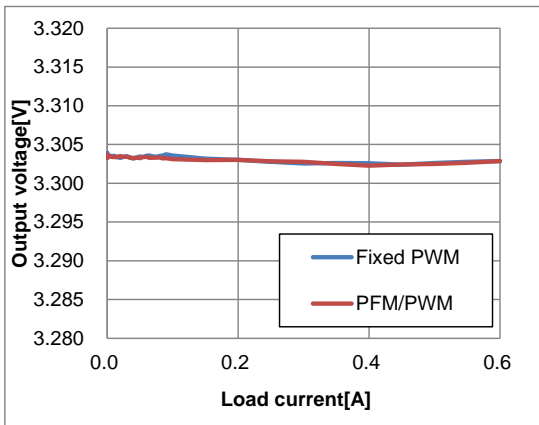

Input Voltage = 5.5V, Vo = 3.3V setting

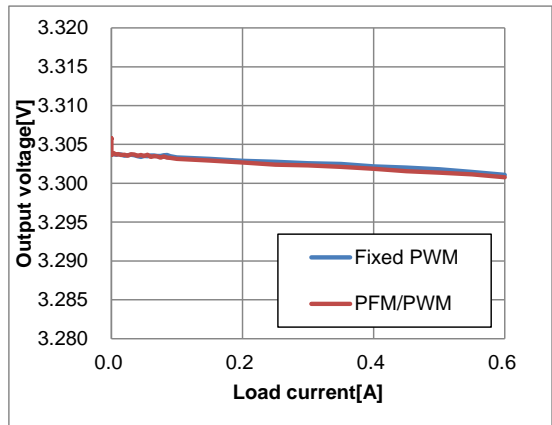

DCDC Converter Output Ripple Voltage

■ **DD1, DD4**

Input voltage = 3.3V, Vo = 1.0V setting
Load current = 0mA , Fixed PWM

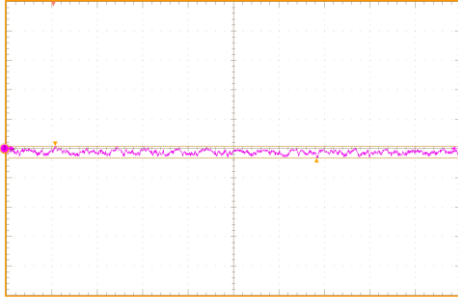

10mV/div, 0.5μs/div

Input voltage = 3.3V, Vo=1.0V setting
Load current = 2000mA, Fixed PWM

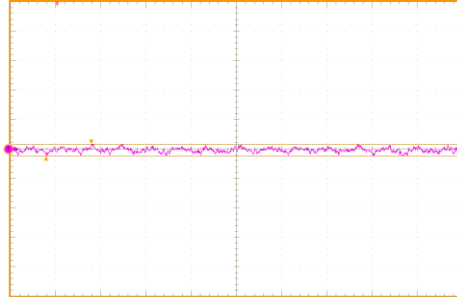

10mV/div, 0.5μs/div

Input voltage = 5.5V, Vo = 1.0V setting
Load current = 0mA , Fixed PWM



10mV/div, 0.5μs/div

Input voltage = 5.5V, Vo = 1.0V setting
Load current = 2000mA, Fixed PWM

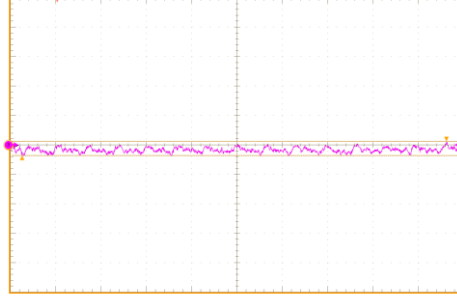

10mV/div, 0.5μs/div

Input voltage = 3.3V, Vo = 1.0V setting
Load current = 0mA , PFM/PWM

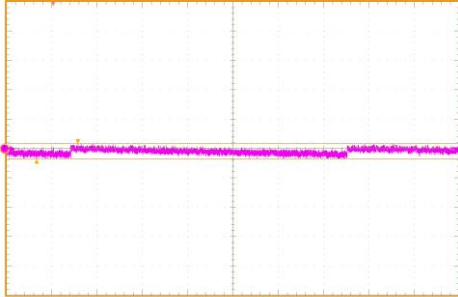

10mV/div, 2ms/div

Input voltage = 3.3V, Vo=1.0V setting
Load current = 2000mA, PFM/PWM

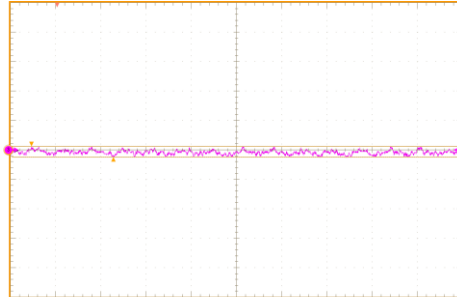

10mV/div, 0.5μs/div

Input voltage = 5.5V, Vo = 1.0V setting
Load current = 0mA , PFM/PWM

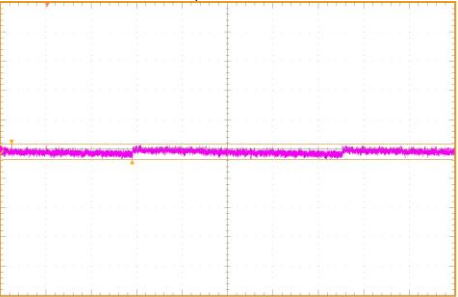

10mV/div, 2ms/div

Input voltage = 5.5V, Vo = 1.0V setting
Load current = 2000mA, PFM/PWM

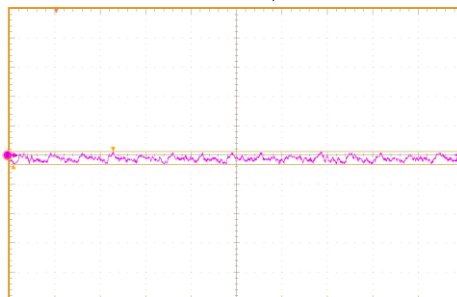

10mV/div, 0.5μs/div

■ DD2

Input voltage = 3.3V, Vo = 1.8V setting
Load current = 0mA , Fixed PWM

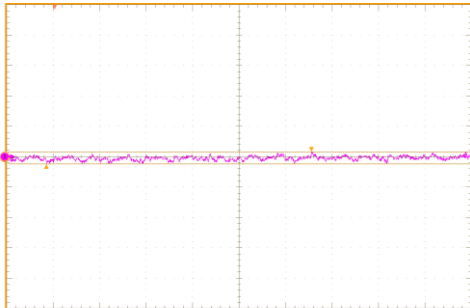

10mV/div, 0.5μs/div

Input voltage = 3.3V, Vo=1.8V setting
Load current = 1200mA, Fixed PWM



10mV/div, 0.5μs/div

Input voltage = 5.5V, Vo = 1.8V setting
Load current = 0mA , Fixed PWM

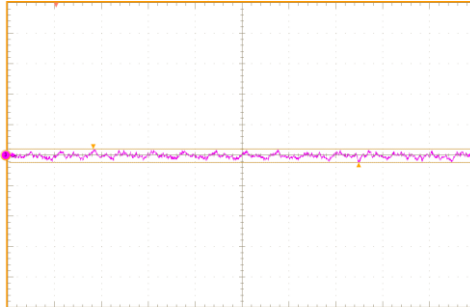

10mV/div, 0.5μs/div

Input voltage = 5.5V, Vo = 1.8V setting
Load current = 1200mA, Fixed PWM

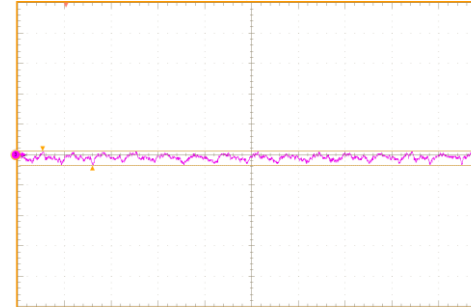

10mV/div, 0.5μs/div

Input voltage = 3.3V, Vo = 1.8V setting
Load current = 0mA , PFM/PWM

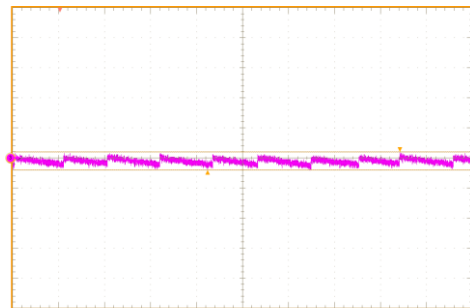

10mV/div, 2ms/div

Input voltage = 3.3V, Vo=1.8V setting
Load current = 1200mA, PFM/PWM

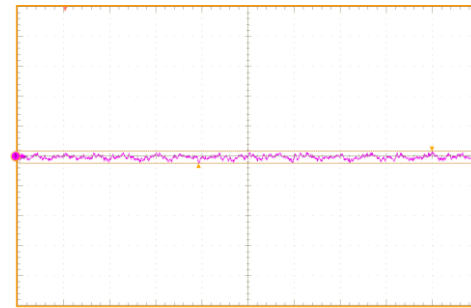

10mV/div, 0.5μs/div

Input voltage = 5.5V, Vo = 1.8V setting
Load current = 0mA , PFM/PWM

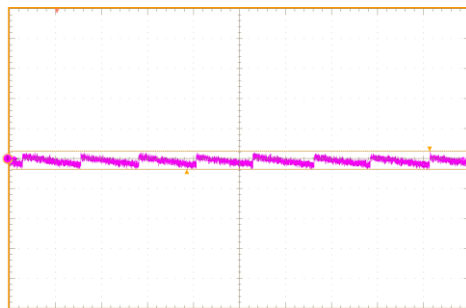

10mV/div, 2ms/div

Input voltage = 5.5V, Vo = 1.8V setting
Load current = 1200mA, PFM/PWM

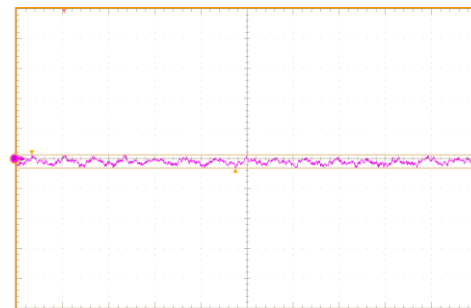

10mV/div, 0.5μs/div

■ DD3

Input voltage = 3.3V, Vo = 3.3V setting
Load current = 0mA , Fixed PWM

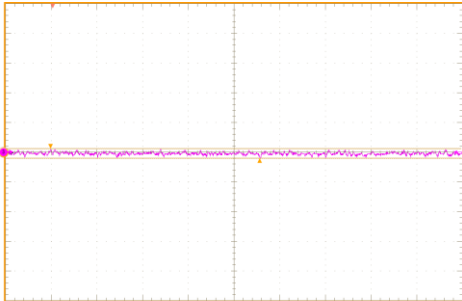

10mV/div, 0.5μs/div

Input voltage = 3.3V, Vo=3.3V setting
Load current = 600mA, Fixed PWM

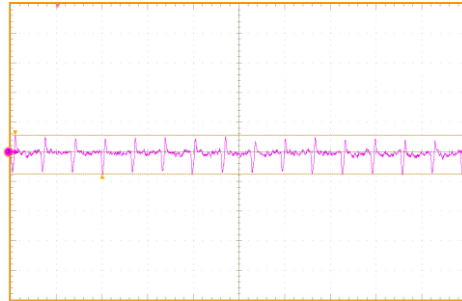

10mV/div, 0.5μs/div

Input voltage = 5.5V, Vo = 3.3V setting
Load current = 0mA , Fixed PWM

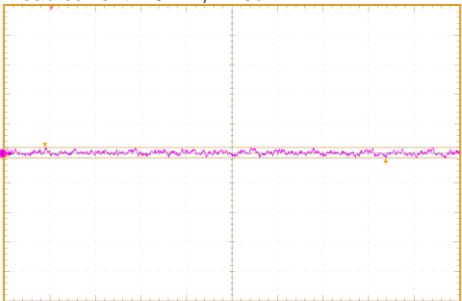

10mV/div, 0.5μs/div

Input voltage = 5.5V, Vo = 3.3V setting
Load current = 600mA, Fixed PWM

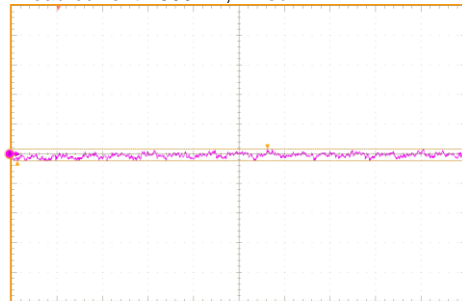

10mV/div, 0.5μs/div

Input voltage = 3.3V, Vo = 3.3V setting
Load current = 0mA , PFM/PWM

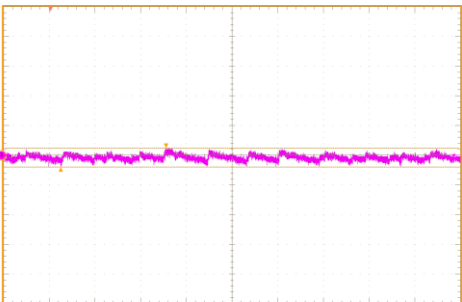

10mV/div, 2ms/div

Input voltage = 3.3V, Vo=3.3V setting
Load current = 600mA, PFM/PWM

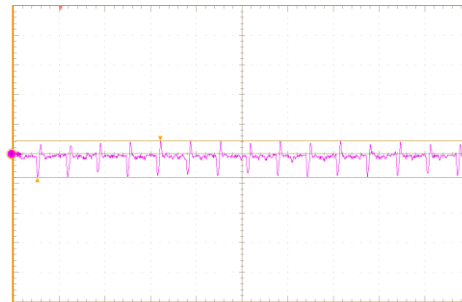

10mV/div, 0.5μs/div

Input voltage = 5.5V, Vo = 1.0V setting
Load current = 0mA , PFM/PWM

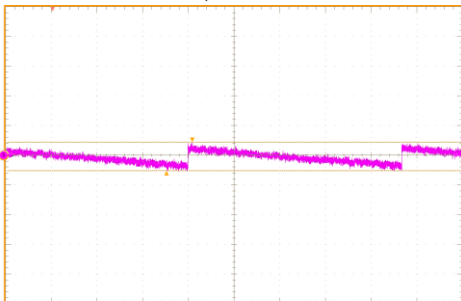

10mV/div, 2ms/div

Input voltage = 3.3V, Vo =3.3V setting
Load current = 600mA, PFM/PWM



10mV/div, 0.5μs/div

DCDC Convertor Enable/disable

■ **DD1,DD4(Fixed PWM)**

Input voltage = 3.3V, Vo = 1.0V setting
Load current = 2000mA, Tss = 1ms setting

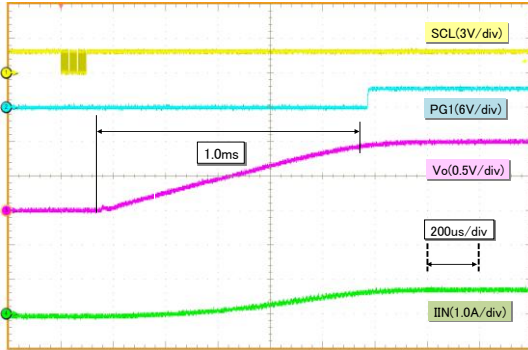

Input voltage = 3.3V, Vo=1.0V setting
Load current = 0mA, Tss = 1ms setting

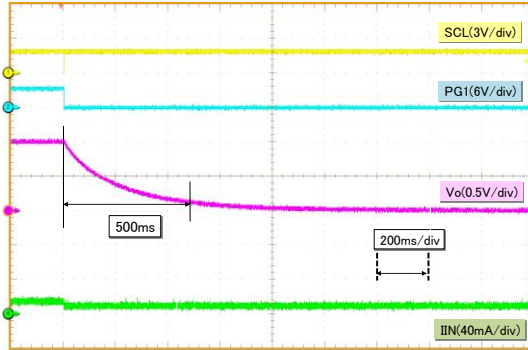

■ **DD1,DD4(PFM/PWM)**

Input voltage = 3.3V, Vo = 1.0V setting
Load current = 2000mA, Tss = 1ms setting

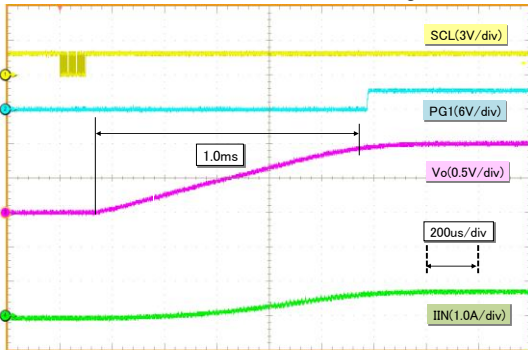

Input voltage = 3.3V, Vo=1.0V setting
Load current = 0mA, Tss = 1ms setting

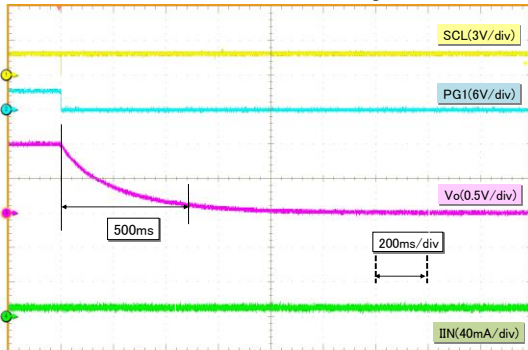

■ **DD2(Fixed PWM)**

Input voltage = 3.3V, Vo = 1.8V setting
Load current = 1200mA, Tss = 1ms setting

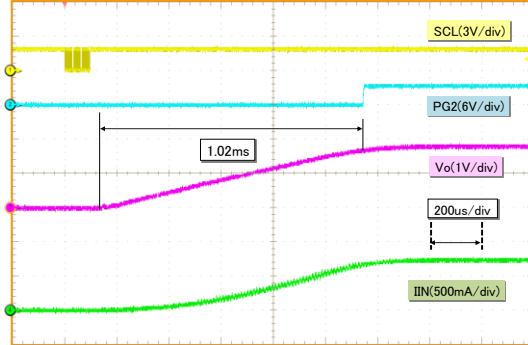

Input voltage = 3.3V, Vo=1.8V setting
Load current = 0mA, Tss = 1ms setting

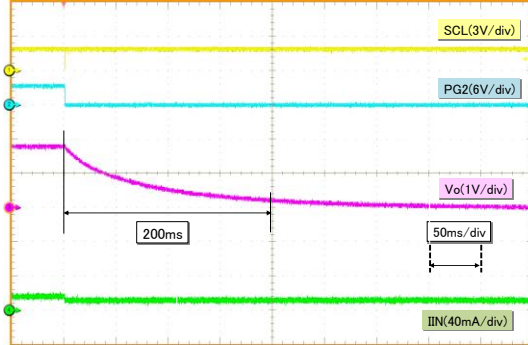

■ **DD2(PFM/ PWM)**

Input voltage = 3.3V, Vo = 1.8V setting
Load current = 1200mA, Tss = 1ms setting

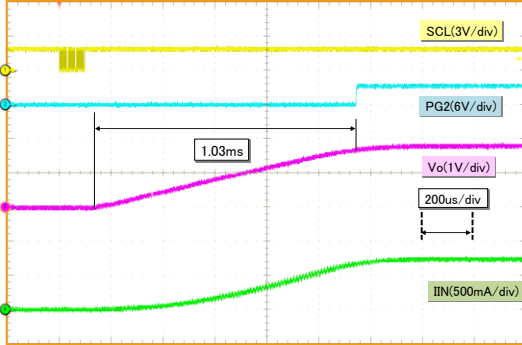

Input voltage = 3.3V, Vo=1.8V setting
Load current = 0mA, Tss = 1ms setting

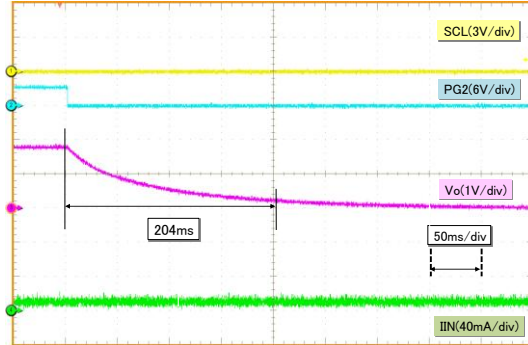

■ **DD3 (Fixed PWM)**

Input voltage = 3.3V, Vo = 3.3V setting
Load current = 600mA, Tss = 1ms setting

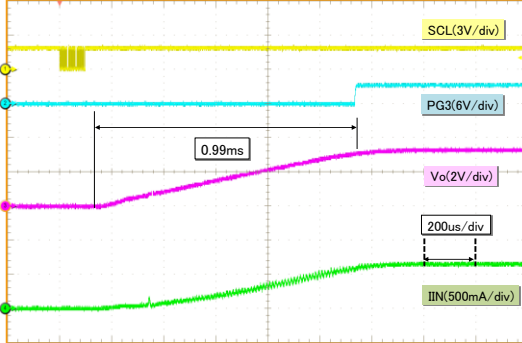

Input voltage = 3.3V, Vo=3.3 V setting
Load current = 0mA, Tss = 1ms setting

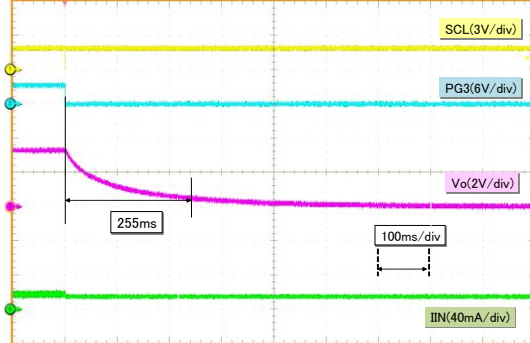

■ **DD3 (PFM/PWM)**

Input voltage = 3.3V, Vo = 3.3V setting
Load current = 600mA, Tss = 1ms setting

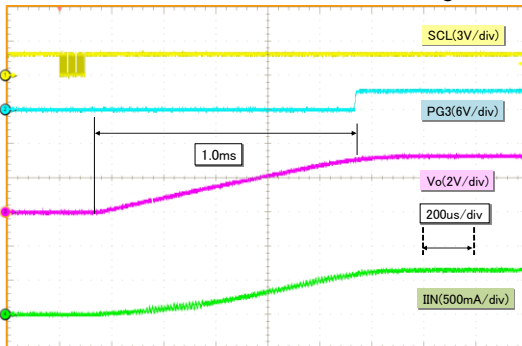

Input voltage = 3.3V, Vo=3.3 V setting
Load current = 0mA, Tss = 1ms setting

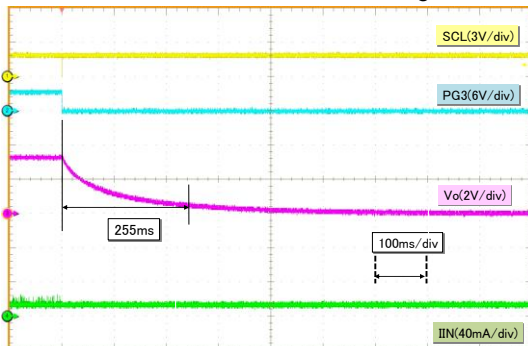

DCDC Converter Load Transient

■ DD1(Fixed PWM)

Input voltage = 3.3V, Vo = 1.0V setting
Load current = from 0mA to 2000mA per 10us

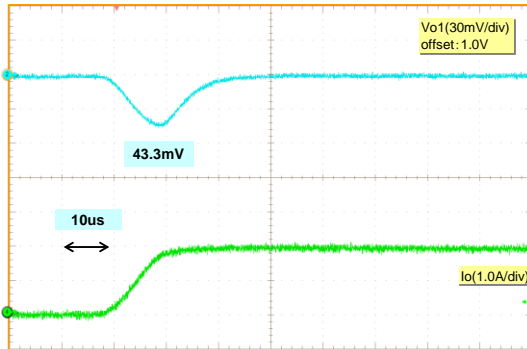

Input voltage = 3.3V, Vo=1.0V setting
Load current = from 2000mA to 0mA per 10us

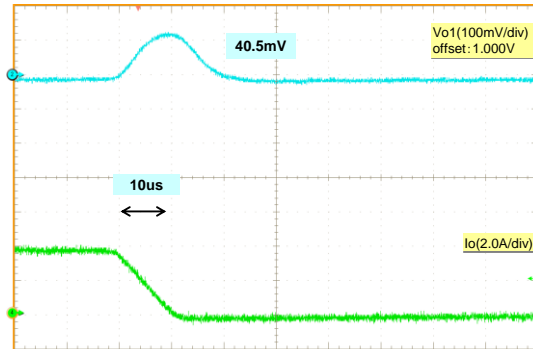

■ DD1(PFM/PWM)

Input voltage = 3.3V, Vo = 1.0V setting
Load current = from 0mA to 2000mA per 10us

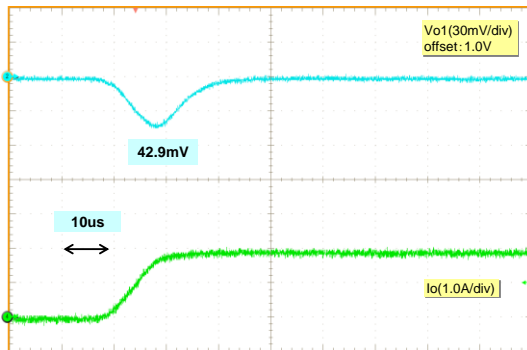

Input voltage = 3.3V, Vo=1.0V setting
Load current = from 2000mA to 0mA per 10us

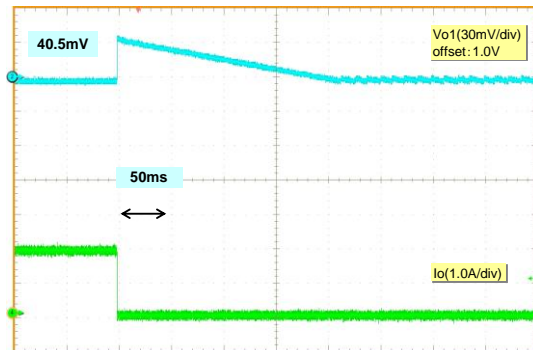

■ DD2(Fixed PWM)

Input voltage = 3.3V, Vo = 1.8V setting
Load current = from 0mA to 1200mA per 10us

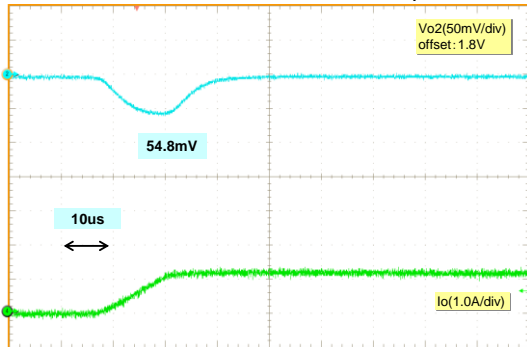

Input voltage = 3.3V, Vo=1.8V setting
Load current = from 1200mA to 0mA per 10us

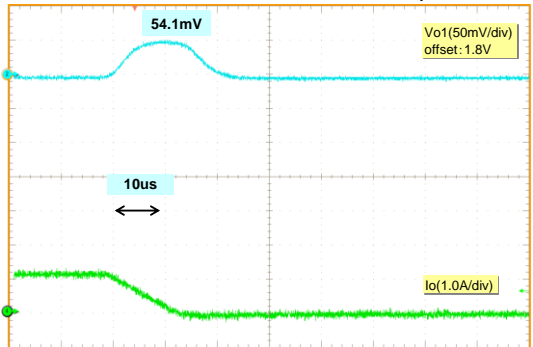

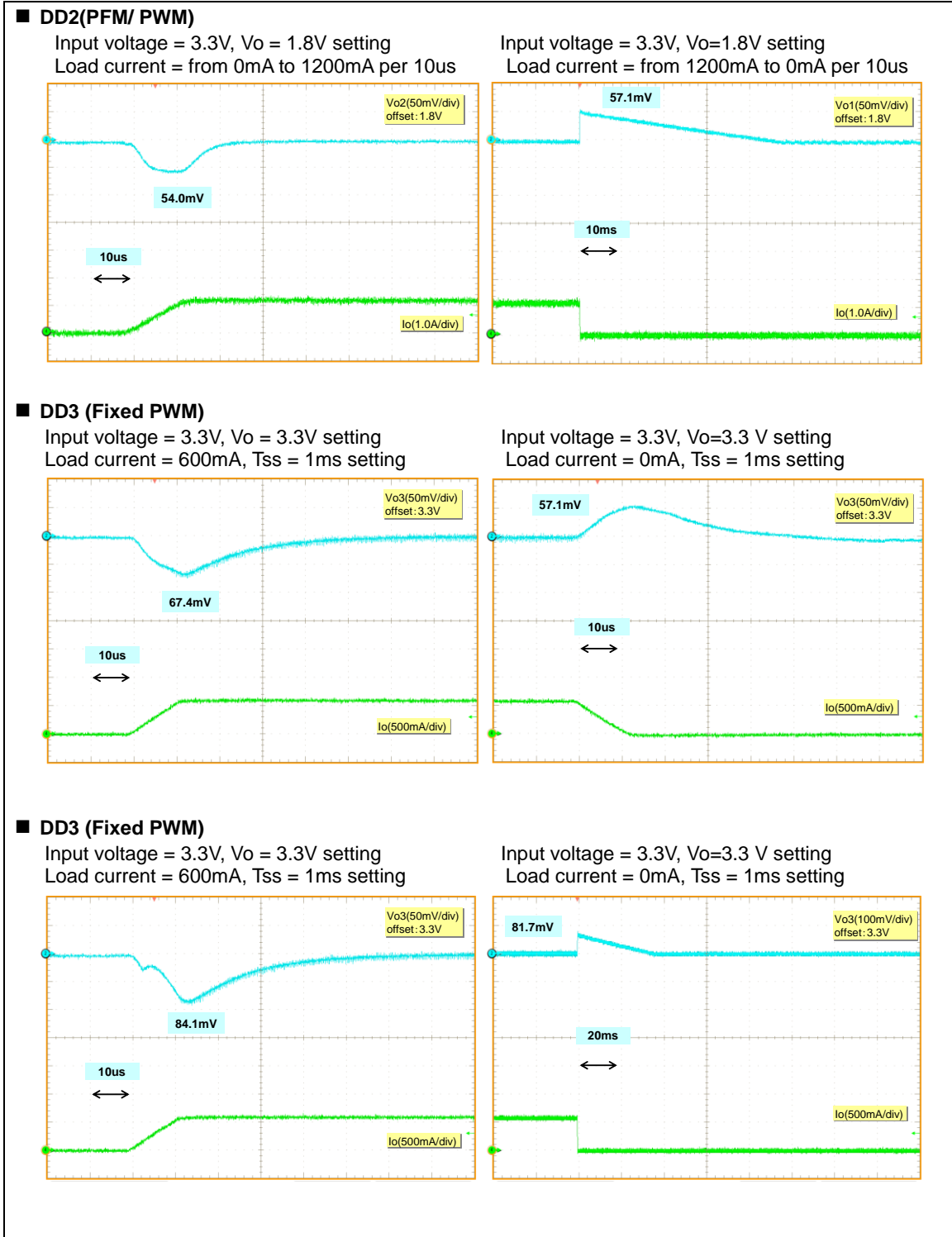

DCDC Converter DVFS Function

■ **DD1 (Fixed PWM)**

Input voltage = 3.3V,
Vo = from 0.7V to 1.32V setting by I²C

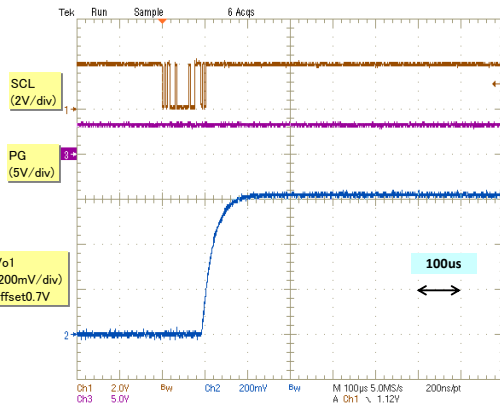

Input voltage = 3.3V
Vo = from 1.32V to 0.7V setting by I²C

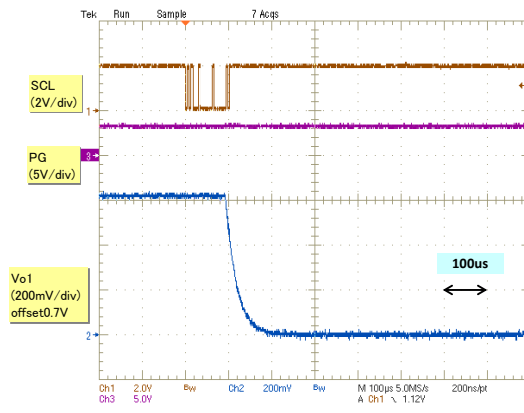

25. Ordering Information

Table 4. Ordering Information

Part Number	Package	Remarks
S6AP413A18GN1C000	32-pin plastic QFN (WNT032)	
S6AP413A19GN1C000		
S6AP413A1AGN1C000		
S6AP413A1BGN1C000		
S6AP413A28GN1C000		
S6AP413A29GN1C000		
S6AP413A2AGN1C000		
S6AP413A2BGN1C000		
S6AP413A38GN1C000		
S6AP413A39GN1C000		
S6AP413A3AGN1C000		
S6AP413A3BGN1C000		
S6AP413A5AGN1C000		
S6AP413A5BGN1C000		
S6AP413A69GN1C000		
S6AP413A6AGN1C000		
S6AP413A6BGN1C000		
S6AP413A79GN1C000		
S6AP413A7AGN1C000		
S6AP413A7BGN1C000		
S6AP413A9AGN1C000		
S6AP413A9BGN1C000		
S6AP413AAAGN1C000		
S6AP413AABGN1C000		
S6AP413ABAGN1C000		
S6AP413ABBGN1C000		
S6AP413ADBGN1C000		
S6AP413AEBGN1C000		
S6AP413AFBGN1C000		

26. Preset Code List

Preset Code	DD1 Output Voltage Preset Code Value	DD2 Output Voltage Preset Code Value	DD3 Output Voltage Preset Code Value	DD3 Output Voltage Preset Code Value
18	0.90V	1.35V	3.30V	0.90V
19	0.90V	1.35V	3.30V	1.00V
1A	0.90V	1.35V	3.30V	1.10V
1B	0.90V	1.35V	3.30V	1.20V
28	0.90V	1.50V	3.30V	0.90V
29	0.90V	1.50V	3.30V	1.00V
2A	0.90V	1.50V	3.30V	1.10V
2B	0.90V	1.50V	3.30V	1.20V
38	0.90V	1.80V	3.30V	0.90V
39	0.90V	1.80V	3.30V	1.00V
3A	0.90V	1.80V	3.30V	1.10V
3B	0.90V	1.80V	3.30V	1.20V
59	1.00V	1.35V	3.30V	1.00V
5A	1.00V	1.35V	3.30V	1.10V
5B	1.00V	1.35V	3.30V	1.20V
69	1.00V	1.50V	3.30V	1.00V
6A	1.00V	1.50V	3.30V	1.10V
6B	1.00V	1.50V	3.30V	1.20V
79	1.00V	1.80V	3.30V	1.00V
7A	1.00V	1.80V	3.30V	1.10V
7B	1.00V	1.80V	3.30V	1.20V
9A	1.10V	1.35V	3.30V	1.10V
9B	1.10V	1.35V	3.30V	1.20V
AA	1.10V	1.50V	3.30V	1.10V
AB	1.10V	1.50V	3.30V	1.20V
BA	1.10V	1.80V	3.30V	1.10V
BB	1.10V	1.80V	3.30V	1.20V
DB	1.20V	1.35V	3.30V	1.20V
EB	1.20V	1.50V	3.30V	1.20V
FB	1.20V	1.80V	3.30V	1.20V

27. Layout

Consider the points listed below and do the layout design.

- Provide the ground plane as much as possible on the IC mounted face. GND and PGNDx provide the through hole proximal to GND and PGNDx pins of IC, and connect it with GND of internal layer.
- Provide the power plane as much as possible to lower impedance of VCC.
- Pay the most attention to the loop composed of input capacitor (CPVCCx) and SWFET. Input capacitor (CPVCCx) connected with PVCCx should be placed close to the pin as much as possible to make the current loop as small as possible. Also connect the GND pin of the input capacitor with PGNDx.
- Output capacitor (CVO3) connected with VO3 should be placed close to the pin as much as possible. Also connect the GND pin of the output capacitor with PGND3.
- GND pins of the switching system parts provide the through hole at the proximal place, and connect it with GND of internal layer.
- By-pass capacitor (CVREF, CAVCC) connected with VREF and AVCC should be placed close to the pin as much as possible. Also connect the GND pin of the by-pass capacitor with GND of internal layer in the proximal through-hole.
- Pull the feedback line to be connected to the INx pin of the IC separately from near the output capacitor pin, whenever possible. Consider the line connected with INx pins to keep away from a switching system parts as much as possible because it is sensitive to the noise.
- There is leaked magnetic flux around the inductor or backside of place equipped with inductor.

Line and parts sensitive to noise should be considered to be placed away from the inductor (or backside of place equipped with inductor).

Switching system parts: Input capacitor (CPVCCx), Inductor (L), Output capacitor(CVOx)

Note:

- x: Each channel number

Figure 7. Layout Example

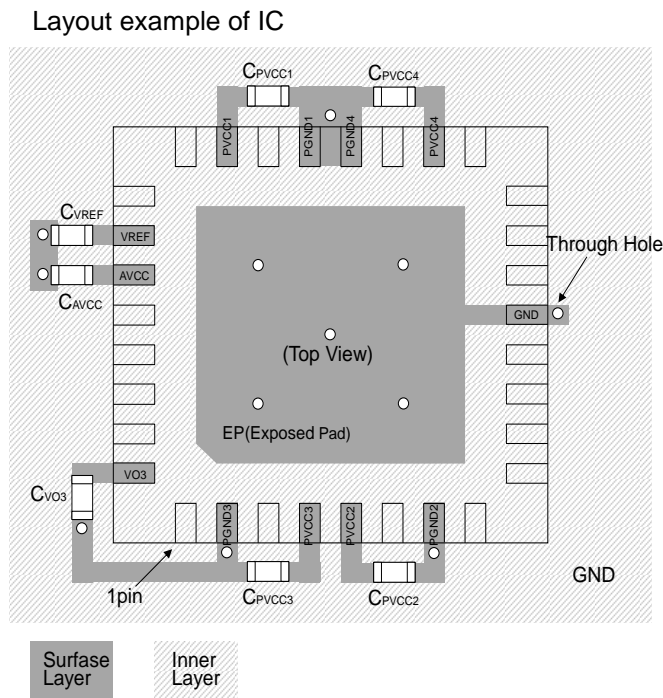

Layout example of switching components 1

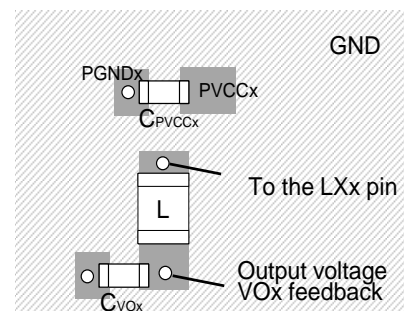

Layout example of switching components 2

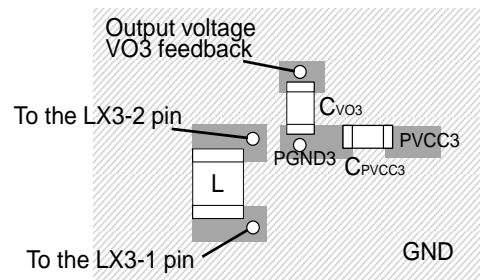

28. Package Dimensions

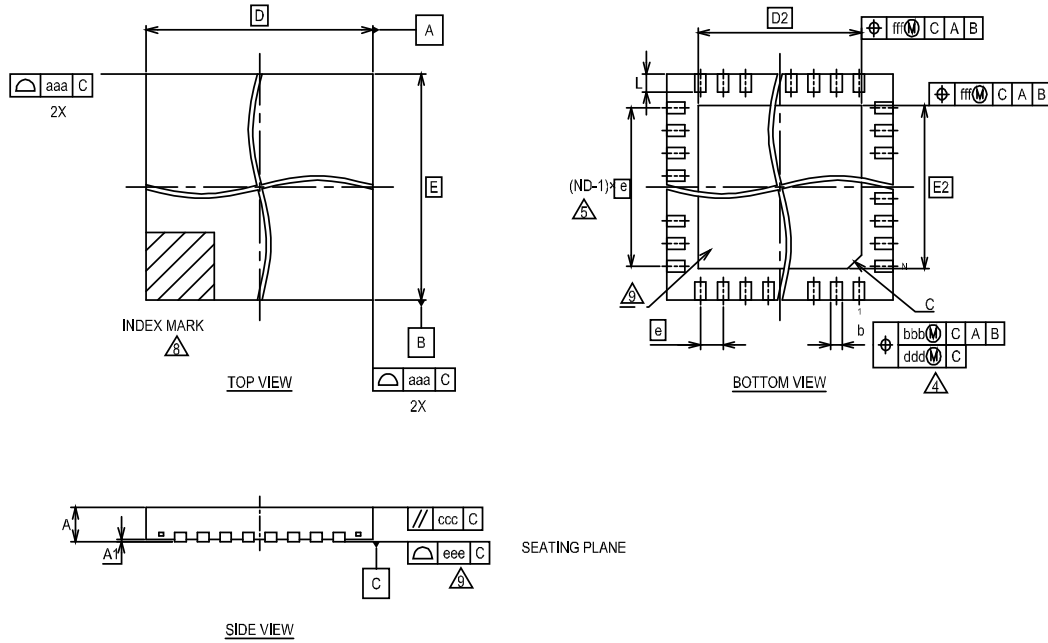

SYMBOL	MILLIMETER			NOTE
	MIN.	NOM.	MAX.	
A	—	—	0.75	PROFILE
A1	0.00	—	0.05	TERMINAL HEIGHT
D	5.00 BSC.			BODY SIZE
E	5.00 BSC.			BODY SIZE
b	0.20	0.25	0.30	TERMINAL WIDTH
D2	3.60 BSC.			EXPOSED PAD SIZE
E2	3.60 BSC.			EXPOSED PAD SIZE
e	0.50 BSC.			TERMINAL PITCH
n	32			TERMINAL COUNT
L	0.33	0.40	0.47	TERMINAL LENGTH
C	C0.30			EXPOSED PAD CHAMFER
aaa	0.07			
bbb	0.10			
ccc	0.10			
ddd	0.05			
eee	0.05			
fff	0.10			

1. DIMENSIONING AND TOLERANCING CONFORMS TO ASME Y14.5-1994.
 2. ALL DIMENSIONS ARE IN MILLIMETERS.
 3. N IS THE TOTAL NUMBER OF TERMINALS.
 4. DIMENSION "b" APPLIES TO METALLIZED TERMINAL AND IS MEASURED BETWEEN 0.15 AND 0.30mm FROM TERMINAL TIP. IF THE TERMINAL HAS THE OPTIONAL RADIUS ON THE OTHER END OF THE TERMINAL THE DIMENSION "b" SHOULD NOT BE MEASURED IN THAT RADIUS AREA.
 5. ND REFER TO THE NUMBER OF TERMINALS ON D OR E SIDE.
 6. MAX. PACKAGE WARPAGE IS 0.05mm.
 7. MAXIMUM ALLOWABLE BURRS IS 0.076mm IN ALL DIRECTIONS.
- ▲ PIN #1 ID ON TOP WILL BE LOCATED WITHIN INDICATED ZONE.
- ▲ BILATERAL COPLANARITY ZONE APPLIES TO THE EXPOSED HEAT SINK SLUG AS WELL AS THE TERMINALS.

29. Major Changes

Spanision Publication Number: S6AP413A_DS405-00019

Page	Section	Descriptions
Revision 0.1		
-	-	Initial release
Revision 1.0		
-	-	Preliminary → Full production
52	26. Measurement Circuit for Characteristics of General Operation	Revised the Parts number of Component list 1278AS-H-1R0M → 1276AS-H-1R0M
65	28. Ordering Information	Revised the Part number of Ordering Information

NOTE: Please see “Document History” about later revised information.

Document History

Document Title: S6AP413A 4ch DC/DC Converter with I²C Interface and Internal SW FETs

Document Number: 002-08448

Revision	ECN	Orig. of Change	Submission Date	Description of Change
**	-	TAOA	12/26/2014	Migrated to Cypress and assigned document number 002-08448. No change to document contents or format.
*A	5146815	TAOA	02/26/2016	Updated to Cypress format.

Sales, Solutions, and Legal Information

Worldwide Sales and Design Support

Cypress maintains a worldwide network of offices, solution centers, manufacturer's representatives, and distributors. To find the office closest to you, visit us at [Cypress Locations](#).

Products

ARM [®] Cortex [®] Microcontrollers	cypress.com/arm
Automotive	cypress.com/automotive
Clocks & Buffers	cypress.com/clocks
Interface	cypress.com/interface
Lighting & Power Control	cypress.com/powerpsoc
Memory	cypress.com/memory
PSoC	cypress.com/psoc
Touch Sensing	cypress.com/touch
USB Controllers	cypress.com/usb
Wireless/RF	cypress.com/wireless

PSoC[®] Solutions

psoc.cypress.com/solutions

[PSoC 1](#) | [PSoC 3](#) | [PSoC 4](#) | [PSoC 5LP](#)

Cypress Developer Community

[Community](#) | [Forums](#) | [Blogs](#) | [Video](#) | [Training](#)

Technical Support

cypress.com/go/support

© Cypress Semiconductor Corporation 2014-2016. This document is the property of Cypress Semiconductor Corporation and its subsidiaries, including Spansion LLC ("Cypress"). This document, including any software or firmware included or referenced in this document ("Software"), is owned by Cypress under the intellectual property laws and treaties of the United States and other countries worldwide. Cypress reserves all rights under such laws and treaties and does not, except as specifically stated in this paragraph, grant any license under its patents, copyrights, trademarks, or other intellectual property rights. If the Software is not accompanied by a license agreement and you do not otherwise have a written agreement with Cypress governing the use of the Software, then Cypress hereby grants you under its copyright rights in the Software, a personal, non-exclusive, nontransferable license (without the right to sublicense) (a) for Software provided in source code form, to modify and reproduce the Software solely for use with Cypress hardware products, only internally within your organization, and (b) to distribute the Software in binary code form externally to end users (either directly or indirectly through resellers and distributors), solely for use on Cypress hardware product units. Cypress also grants you a personal, non-exclusive, nontransferable, license (without the right to sublicense) under those claims of Cypress's patents that are infringed by the Software (as provided by Cypress, unmodified) to make, use, distribute, and import the Software solely to the minimum extent that is necessary for you to exercise your rights under the copyright license granted in the previous sentence. Any other use, reproduction, modification, translation, or compilation of the Software is prohibited.

CYPRESS MAKES NO WARRANTY OF ANY KIND, EXPRESS OR IMPLIED, WITH REGARD TO THIS DOCUMENT OR ANY SOFTWARE, INCLUDING, BUT NOT LIMITED TO, THE IMPLIED WARRANTIES OF MERCHANTABILITY AND FITNESS FOR A PARTICULAR PURPOSE. Cypress reserves the right to make changes to this document without further notice. Cypress does not assume any liability arising out of the application or use of any product or circuit described in this document. Any information provided in this document, including any sample design information or programming code, is provided only for reference purposes. It is the responsibility of the user of this document to properly design, program, and test the functionality and safety of any application made of this information and any resulting product. Cypress products are not designed, intended, or authorized for use as critical components in systems designed or intended for the operation of weapons, weapons systems, nuclear installations, life-support devices or systems, other medical devices or systems (including resuscitation equipment and surgical implants), pollution control or hazardous substances management, or other uses where the failure of the device or system could cause personal injury, death, or property damage ("Unintended Uses"). A critical component is any component of a device or system whose failure to perform can be reasonably expected to cause the failure of the device or system, or to affect its safety or effectiveness. Cypress is not liable, in whole or in part, and Company shall and hereby does release Cypress from any claim, damage, or other liability arising from or related to all Unintended Uses of Cypress products. Company shall indemnify and hold Cypress harmless from and against all claims, costs, damages, and other liabilities, including claims for personal injury or death, arising from or related to any Unintended Uses of Cypress products.

Cypress, the Cypress logo, Spansion, the Spansion logo, and combinations thereof, PSoC, CapSense, EZ-USB, F-RAM, and Traveo are trademarks or registered trademarks of Cypress in the United States and other countries. For a more complete list of Cypress trademarks, visit cypress.com. Other names and brands may be claimed as property of their respective owners.

X-ON Electronics

Largest Supplier of Electrical and Electronic Components

Click to view similar products for [Switching Voltage Regulators](#) category:

Click to view products by [Cypress](#) manufacturer:

Other Similar products are found below :

[FAN53610AUC33X](#) [FAN53611AUC123X](#) [FAN48610BUC33X](#) [FAN48610BUC45X](#) [FAN48617UC50X](#) [R3](#) [430464BB](#) [MIC45116-1YMP-T1](#) [KE177614](#) [MAX809TTR](#) [NCV891234MW50R2G](#) [NCP81103MNTXG](#) [NCP81203PMNTXG](#) [NCP81208MNTXG](#) [NCP81109GMNTXG](#) [SCY1751FCCT1G](#) [NCP81109JMNTXG](#) [AP3409ADNTR-G1](#) [LTM8064IY](#) [LT8315EFE#TRPBF](#) [NCV1077CSTBT3G](#) [DA9121-B0V76](#) [LTC3644IY#PBF](#) [LD8116CGL](#) [HG2269M/TR](#) [OB2269](#) [XD3526](#) [U6215A](#) [U6215B](#) [U6620S](#) [LTC3803ES6#TR](#) [LTC3803ES6#TRM](#) [LTC3412IFE](#) [LT1425IS](#) [MAX25203BATJA/VY+](#) [MAX77874CEWM+](#) [XC9236D08CER-G](#) [ISL95338IRTZ](#) [MP3416GJ-P](#) [BD9S201NUX-CE2](#) [MP5461GC-Z](#) [MPQ4415AGQB-Z](#) [MPQ4590GS-Z](#) [LX7178-01CSP-TR](#) [MCP1642B-18IMC](#) [MCP1642D-ADJIMC](#) [MCP1642D-18IMC](#) [MCP1642D-30IMC](#) [MCP1665T-E/MRA](#) [MIC2876-4.75YMT-T5](#)