

REV. 版本	ECN MO. 变更说明	DATE 日期
A-D	见老版图纸	
E	图纸整理	2018.05.09

SC02

NOTE:
MATERIAL:

- CONTACT: PHOSPHOR BRONZE.
- CONNECTOR HOUSING: LCP UL 94V-0. COLOR: BLACK.
- MOULDED INSERT: HIGH TEMPERATURE PLASTIC UL 94V-0. COLOR:BLACK.
- CAGE: COPPER ALLOY.
- LIGHT PIPES: POLYCARBONATE. UL 94V-0. COLOR:CLEAR
- LIGHT PIPE HOUSING: PBT UL 94V-0 COLOR:BLACK.

PLATED:

- CONTACT MATING AREA : PLATING GOLD OVER 1.27 MICROMETERS MINIMUM

NICKEL:

- CONTACT NEEDLE EYE: 2.54 MICROMETERS MINIMUM MATTE TIN OVER 1.27 MICROMETERS MINIMUM NICKEL.

MECHANICAL REQUIREMENT:

- DURABILITY: 100 CYCLES MIN.
- INSERTION AND EXTRACTION FORCE: 40N MAX & 11.5N MAX

ENVIRONMENTAL:

- LOW LEVEL CONTACT RESITANCE(LLCR):
ΔR 10 MILLIOHMS MAXIMUM FOR SHIELD AND SIGNAL CONTACTS.
- DIELECTRIC WITHSTANDING VOLTAGE: 300V AC/MAX.
- INSULATION RESISTANCE: 1×10^9 OHMS MINIMUM.
- RATINGS CURRENT: 0.5 AMPS MAX.
- RATINGS VOLTAGE: 30 VOLTS DC/AC(RMS) MAX.
- OPERATION: $-40^{\circ}\text{C} \sim +85^{\circ}\text{C}$.
- STORAGE: $-55^{\circ}\text{C} \sim +105^{\circ}\text{C}$.
- ROHS COMPLIANT

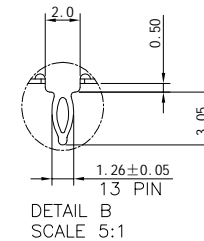
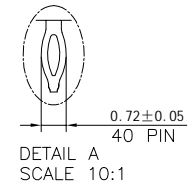
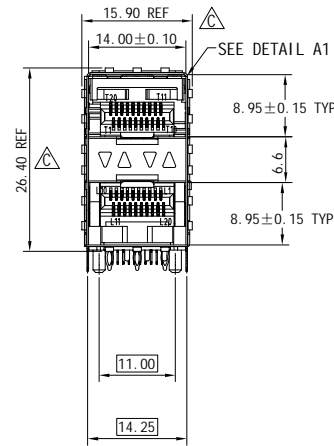
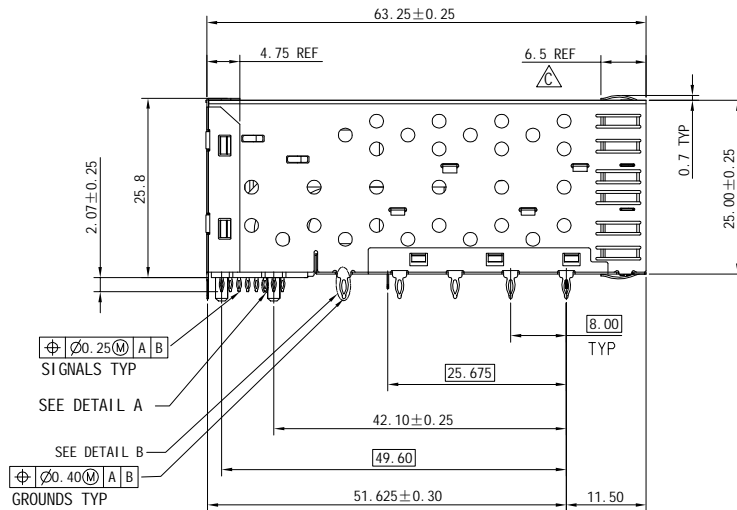
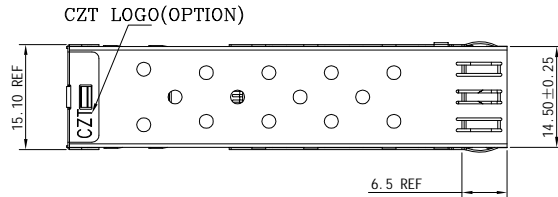

RoHS Compliant

CZT 温州意华接插件股份有限公司
WENZHOU YIHUA CONNECTOR CO., LTD

TOLERANCES 公差
.X ± 0.25
.XX ± 0.13
.XXX ± 0.10
ANGLES: ± 2°

Material: 材质
Finish: 电镀

SEE NOTE
SEE NOTE

Designed: 设计
Checked: 审核
Approved: 核准

Lamei Tang
Qi anpu Zhao
Robi n

NAME: 名称
DWG NO: 图号
PART NO: 料号

SFP 2X1 CONNECTOR
ESFP-021-01-C
SEE TABLE

REV. 版本
E

第三视角
A4
SIZE

SCALE 比例
2:1

UNIT 单位
mm

CUSTOMER: 客户
MODEL NO: 模号

N/A
N/A

SHEET 1 OF 5
第 页 共 页

REV. 版本	ECN MO. 变更说明	DATE 日期

SC02

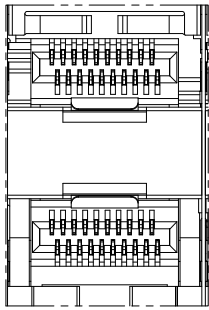

TYPE1_NONE LIGHT PIPES

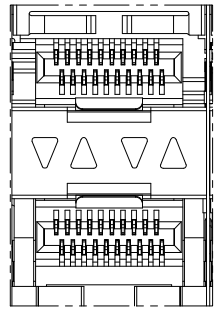

TYPE2_4 LIGHT PIPES

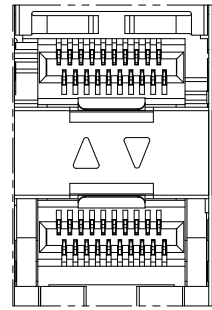

TYPE1_3 INNER LIGHT PIPES

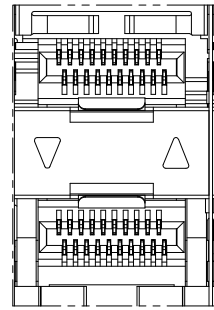

TYPE4_2 OUTER LIGHT PIPES

LIGHT PIPE CONFIGURATION
DETAIL D SCALE 2:1

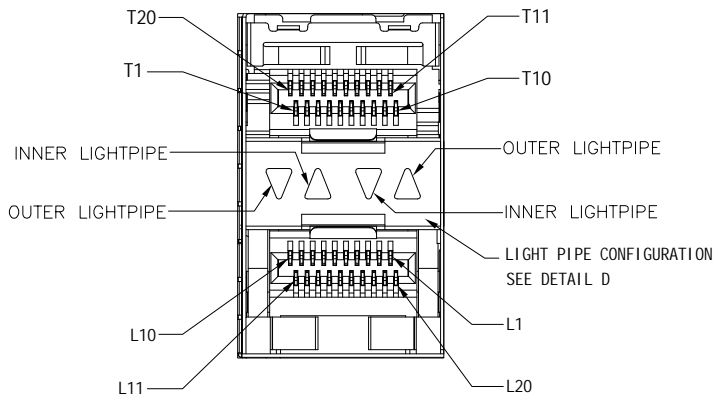

DETAIL A1
SCALE 4:1

RoHS Compliant

CZT® 温州意华接插件股份有限公司
WENZHOU YIHUA CONNECTOR CO., LTD

TOLERANCES 公差
.X ±0.25
.XX ±0.13
.XXX ±0.10
ANGLES: ±2°

Material: 材质
Finish: 电镀

SEE NOTE
SEE NOTE

Designed: 设计
Checked: 审核
Approved: 核准

Lamei Tang
Qi anpu Zhao
Robi n

NAME: 名称
DWG NO: 图号
PART NO: 料号

SFP 2X1 CONNECTOR
ESFP-021-01-C
SEE TABLE

REV. 版本
E

第三视角

A4 SIZE

SCALE 比例 2:1
UNIT 单位 mm

CUSTOMER: 客户 N/A
MODEL NO: 模号 N/A



SHEET 2 OF 5
第 页 共 页

REV. 版本	ECN MO. 变更说明	DATE 日期

SC02

10705221D002	B869S-0015-Y005	SFP 2X1 PRESS FIT CONNECTOR	WITH INNER/OUTER LIGHT PIPES	▽△▽△	15u"	WITHOUT CZT LOGO	UNPLATED
10705121D002	B869S-0015-Y004	SFP 2X1 PRESS FIT CONNECTOR	WITHOUT LIGHT PIPES		15u"	WITHOUT CZT LOGO	UNPLATED
10705221D005	B869S-0015-Y024	SFP 2X1 PRESS FIT CONNECTOR	WITH OUTER LIGHT PIPES	▽ △	15u"	WITHOUT CZT LOGO	UNPLATED
10705221D024	B869S-0015-Y026	SFP 2X1 PRESS FIT CONNECTOR	WITH INNER LIGHT PIPES	△ ▽	15u"	WITHOUT CZT LOGO	UNPLATED
10705221F001	B869S-0030-Y003	SFP 2X1 PRESS FIT CONNECTOR	WITH INNER/OUTER LIGHT PIPES	▽△▽△	30u"	WITHOUT CZT LOGO	UNPLATED
10705121F008	B869S-0030-Y004	SFP 2X1 PRESS FIT CONNECTOR	WITHOUT LIGHT PIPES		30u"	WITHOUT CZT LOGO	UNPLATED
10705221F009	B869S-0030-Y011	SFP 2X1 PRESS FIT CONNECTOR	WITH OUTER LIGHT PIPES	▽ △	30u"	WITHOUT CZT LOGO	UNPLATED
10705221F002	B869S-0030-Y009	SFP 2X1 PRESS FIT CONNECTOR	WITH INNER LIGHT PIPES	△ ▽	30u"	WITHOUT CZT LOGO	UNPLATED
10705221D047	B869S-0015-Y067	SFP 2X1 PRESS FIT CONNECTOR	WITH INNER/OUTER LIGHT PIPES	▽△▽△	15u"	WITHOUT CZT LOGO	Ni 30u"MIN
10705121D009	B869S-0015-Y060	SFP 2X1 PRESS FIT CONNECTOR	WITHOUT LIGHT PIPES		15u"	WITHOUT CZT LOGO	Ni 30u"MIN
10705221D049		SFP 2X1 PRESS FIT CONNECTOR	WITH OUTER LIGHT PIPES	▽ △	15u"	WITHOUT CZT LOGO	Ni 30u"MIN
10705221D050		SFP 2X1 PRESS FIT CONNECTOR	WITH INNER LIGHT PIPES	△ ▽	15u"	WITHOUT CZT LOGO	Ni 30u"MIN
10705221F024		SFP 2X1 PRESS FIT CONNECTOR	WITH INNER/OUTER LIGHT PIPES	▽△▽△	30u"	WITHOUT CZT LOGO	Ni 30u"MIN
10705121F004		SFP 2X1 PRESS FIT CONNECTOR	WITHOUT LIGHT PIPES		30u"	WITHOUT CZT LOGO	Ni 30u"MIN
10705221F025		SFP 2X1 PRESS FIT CONNECTOR	WITH OUTER LIGHT PIPES	▽ △	30u"	WITHOUT CZT LOGO	Ni 30u"MIN
10705221F026		SFP 2X1 PRESS FIT CONNECTOR	WITH INNER LIGHT PIPES	△ ▽	30u"	WITHOUT CZT LOGO	Ni 30u"MIN
10705221D001	B869S-0015-Y003	SFP 2X1 PRESS FIT CONNECTOR	WITH INNER/OUTER LIGHT PIPES	▽△▽△	15u"	WITH CZT LOGO	UNPLATED
10705121D007	B869S-0015-Y053	SFP 2X1 PRESS FIT CONNECTOR	WITHOUT LIGHT PIPES		15u"	WITH CZT LOGO	UNPLATED
10705221D008	B869S-0015-Y023	SFP 2X1 PRESS FIT CONNECTOR	WITH OUTER LIGHT PIPES	▽ △	15u"	WITH CZT LOGO	UNPLATED
10705221D009	B869S-0015-Y025	SFP 2X1 PRESS FIT CONNECTOR	WITH INNER LIGHT PIPES	△ ▽	15u"	WITH CZT LOGO	UNPLATED
10705221F021	B869S-0030-Y015	SFP 2X1 PRESS FIT CONNECTOR	WITH INNER/OUTER LIGHT PIPES	▽△▽△	30u"	WITH CZT LOGO	UNPLATED
10705121F007	B869S-0030-Y024	SFP 2X1 PRESS FIT CONNECTOR	WITHOUT LIGHT PIPES		30u"	WITH CZT LOGO	UNPLATED
10705221F022	B869S-0030-Y012	SFP 2X1 PRESS FIT CONNECTOR	WITH OUTER LIGHT PIPES	▽ △	30u"	WITH CZT LOGO	UNPLATED
10705221F023	B869S-0030-Y013	SFP 2X1 PRESS FIT CONNECTOR	WITH INNER LIGHT PIPES	△ ▽	30u"	WITH CZT LOGO	UNPLATED
10705221D011	B869S-0015-Y066	SFP 2X1 PRESS FIT CONNECTOR	WITH INNER/OUTER LIGHT PIPES	▽△▽△	15u"	WITH CZT LOGO	Ni 30u"MIN
10705121D008	B869S-0015-Y054	SFP 2X1 PRESS FIT CONNECTOR	WITHOUT LIGHT PIPES		15u"	WITH CZT LOGO	Ni 30u"MIN
10705221D025		SFP 2X1 PRESS FIT CONNECTOR	WITH OUTER LIGHT PIPES	▽ △	15u"	WITH CZT LOGO	Ni 30u"MIN
10705221D048		SFP 2X1 PRESS FIT CONNECTOR	WITH INNER LIGHT PIPES	△ ▽	15u"	WITH CZT LOGO	Ni 30u"MIN
10705221F027		SFP 2X1 PRESS FIT CONNECTOR	WITH INNER/OUTER LIGHT PIPES	▽△▽△	30u"	WITH CZT LOGO	Ni 30u"MIN
10705121F003		SFP 2X1 PRESS FIT CONNECTOR	WITHOUT LIGHT PIPES		30u"	WITH CZT LOGO	Ni 30u"MIN
10705221F028		SFP 2X1 PRESS FIT CONNECTOR	WITH OUTER LIGHT PIPES	▽ △	30u"	WITH CZT LOGO	Ni 30u"MIN
10705221F029		SFP 2X1 PRESS FIT CONNECTOR	WITH INNER LIGHT PIPES	△ ▽	30u"	WITH CZT LOGO	Ni 30u"MIN

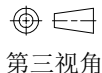
RoHS Compliant

 温州意华接插件股份有限公司 WENZHOUI YIHUA CONNECTOR CO., LTD		TOLERANCES 公差 .X ±0.25 .XX ±0.13 .XXX ±0.10 ANGLES: ±2°		Material: 材质 SEE NOTE Finish: 电镀 SEE NOTE		Designed: 设计 Lamei Tang Checked: 审核 Qi anpu Zhao Approved: 核准 Robi n		CONTACT PLATING GOLD NAME: 名称 SFP 2X1 CONNECTOR DWG NO: 图号 ESFP-021-01-C PART NO: 料号 SEE TABLE		REV. 版本 E
 第三视角	A4 SIZE	SCALE 比例 2:1	UNIT 单位 mm	CUSTOMER: 客户 N/A	MODEL NO: 模号 N/A	SHEET 3 OF 5 第 页 共 页		SEE TABLE		REV. 版本 E

REV. 版本	ECN MO. 变更说明	DATE 日期

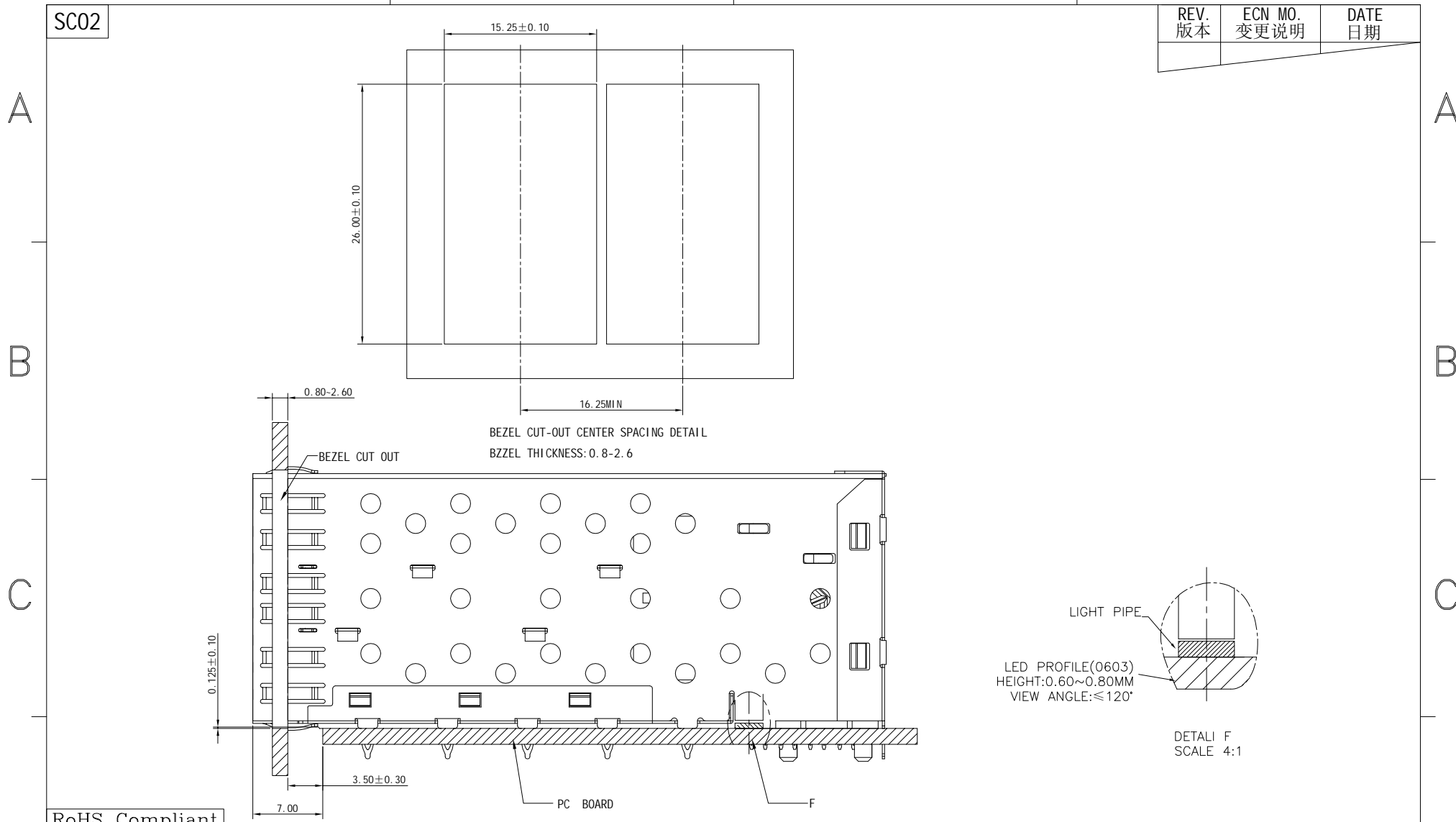

RoHS Compliant

CZT® 温州意华接插件股份有限公司
WENZHOU YIHUA CONNECTOR CO., LTD

第三视角	A4 SIZE	SCALE 比例	UNIT 单位	CUSTOMER: 客户	N/A
		2:1	mm	MODEL NO: 模号	N/A

TOLERANCES
公差
.X ±0.25
.XX ±0.13
.XXX ±0.10
ANGLES: ±2°

Material: 材质	SEE NOTE
Finish: 电镀	SEE NOTE
SHEET 4 OF 5 第 4 页 共 5 页	

Designed: 设计	Lamei Tang
Checked: 审核	Qi anpu Zhao
Approved: 核准	Robi n

NAME: 名称	SFP 2X1 CONNECTOR	
DWG NO: 图号	ESFP-021-01-C	REV. 版本
PART NO: 料号	SEE TABLE	E

REV. 版本	ECN MO. 变更说明	DATE 日期

SC02

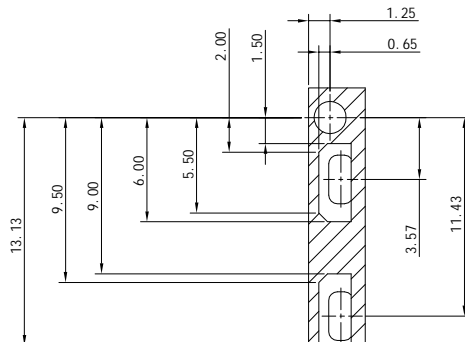
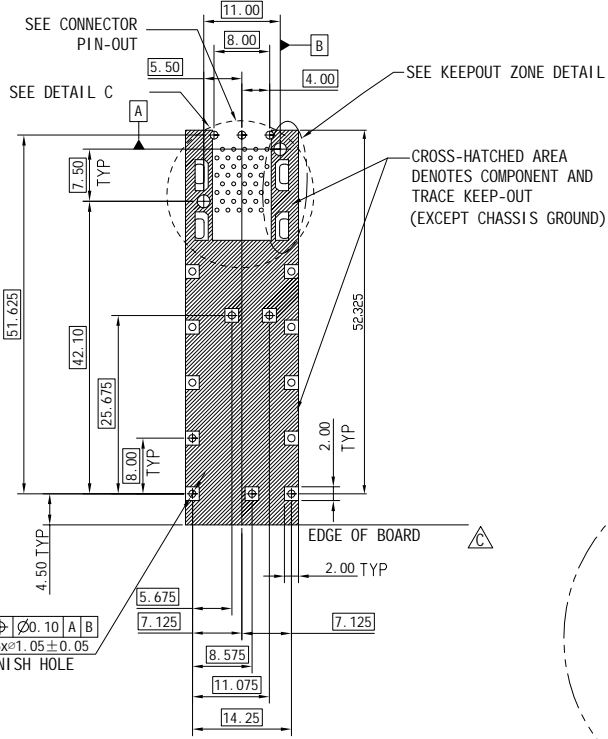

KEEPOUT ZONE
DETAIL SCALE 5:1

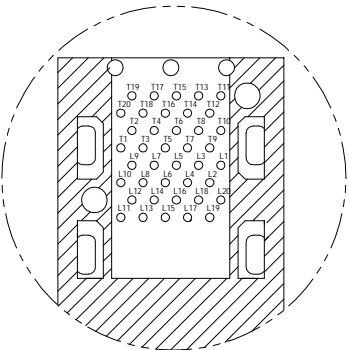

CONNECTOR PIN-OUT
COMPONENT SIDE OF BOARD

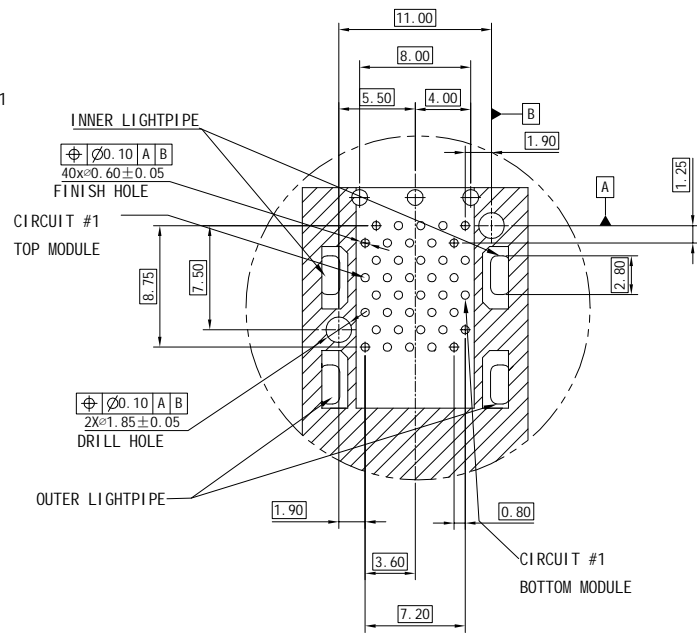

DETAIL C
SCALE 5:1

RECOMMENDED PCB LAYOUT-COMPONENT SIDE
RECOMMENDED PCB THICKNESS-2.63MM

THE ENTIRE AREA OF THE CONNECTOR FOOTPRINT
TO BE CONSIDERED THE KEEP OUT AREA FOR COMPONENTS
(OTHER THAN LIGHT PIPE LED'S)
THIS AREA IS INDICATED BY THE DASHED LINE

RoHS Compliant

CZT 温州意华接插件股份有限公司
WENZHOU YIHUA CONNECTOR CO., LTD

第三视角	A4 SIZE	SCALE 比例 2:1	UNIT 单位 mm	CUSTOMER: 客户 MODEL NO: 模号	N/A N/A
------	------------	--------------------	------------------	------------------------------------	------------

TOLERANCES
公差
.X ±0.25
.XX ±0.13
.XXX ±0.10
ANGLES: ±2°

Material:
材质
SEE NOTE

Finish:
电镀
SEE NOTE

SHEET 5 OF 5
第 5 页 共 5 页

Designed:
设计
Lamei Tang

Checked:
审核
Qi anpu Zhao

Approved:
核准
Robi n

NAME:
名称
SFP 2X1 CONNECTOR

DWG NO:
图号
ESFP-021-01-C

PART NO:
料号
SEE TABLE

REV.
版本
E

X-ON Electronics

Largest Supplier of Electrical and Electronic Components

Click to view similar products for [Headers & Wire Housings](#) category:

Click to view products by [CZT](#) manufacturer:

Other Similar products are found below :

[95000-104TRLF](#) [10135584-644402LF](#) [DF62W-EP2022PCA](#) [95000-106TRLF](#) [DF62W-2022SCA](#) [DF62W-EP2022PC](#) [2203348](#) [DF62W-2022SC](#) [1084018](#) [1029039](#) [1084017](#) [802-10-012-10-002000](#) [1112640](#) [1112639](#) [891-007-9SS-BST1T](#) [000-34000](#) [0008550134](#) [0009482033](#) [0009507031](#) [57102-F02-18ULF](#) [57102-S06-03LF](#) [57202-S52-04LF](#) [PCN6-15S-2.5E](#) [0039019024](#) [58102-G61-06LF](#) [582553-1](#) [0009485154](#) [0009508121](#) [0022285053](#) [0050291907](#) [018731A](#) [LY20-4P-DT1-P1E-BR](#) [02.125.8002.8](#) [60101931](#) [60598-1 \(Cut Strip\)](#) [M1625-3R/100](#) [61062-3](#) [61082-181009](#) [CSU011177004](#) [636-1427](#) [638009-1](#) [641938-9](#) [641991-4](#) [644168-1](#) [644827-2](#) [647662-1](#) [65039-019ELF](#) [65692-001LF](#) [65781-018](#) [65781-047](#)