



IGBT Module 75A

Features

- ◆ Non Punch Through (NPT) Technology
- ◆ IGBT trench technology
- ◆ Superfast diodes
- ◆ High short circuit capability

Preliminary

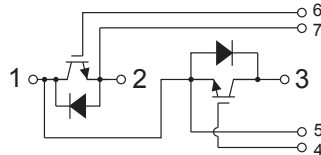

Applications

- ◆ Welder / Power Supply
- ◆ UPS / Inverter
- ◆ Industrial Motor Drive

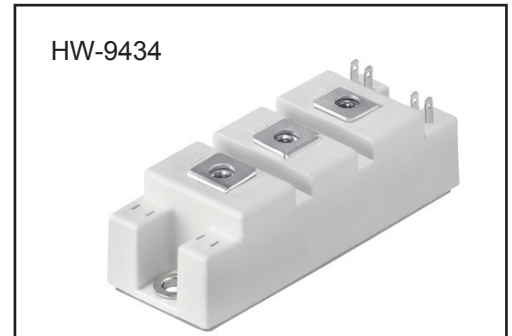

Maximum Ratings (T_C=25°C)

Item	Symbol	Rated Value	Unit
Collector-Emitter Voltage	V _{CES}	600	V
Gate-Emitter Voltage	V _{GES}	±20	V
Collector Current	DC	I _C	75
	1ms	I _{CP}	150
Collector Power Dissipation	P _C	350	W
Isolation Voltag (e Terminal to Base, AC 1 min.)	V _{iso}	2500	V
Junction Temperature Range	T _J	-40~+150	°C
Storage Temperature Range	T _{stg}	-40~+125	°C
Mounting Torque	Module Base to Heatsink	5	N.m
	Busbar to Terminal	5	

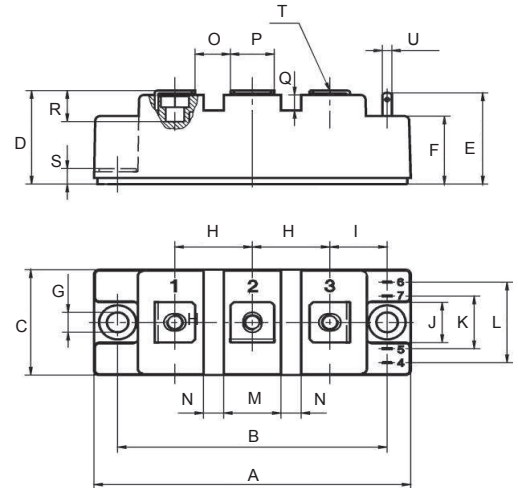

DIM	DIMENSIONS				NOTE
	INCHES		MM		
A	...	3.700	...	94.0	
B	3.134	3.165	79.6	80.4	
C	...	1.339	...	34.0	
D	...	1.201	...	30.5	
E	...	1.181	...	30.0	
F866	...	22.0	
G252	...	6.4	∅
H	.894	.917	22.7	23.3	
I670	...	17.0	
J512	...	13.0	
K677	...	17.2	
L	...	1.024	...	26.0	
M699	...	17.0	
N236	...	6.0	
O413	...	10.5	
P512	...	13.0	
Q217	...	5.5	
R512	...	13.0	
S197	...	5.0	
T	M5				
U	...	110*20	...	2.8*0.5	



■ **Electrical Characteristics** ($T_C=25^{\circ}C$)

Characteristic		Symbol	Test Conditions	Min.	Typ.	Max.	Unit
Collector-Emitter Cut-Off Current		I_{CES}	$V_{CE}=600V$ $V_{GE}=0V$	-	-	1	mA
Gate-Emitter Leakage Current		I_{GES}	$V_{GE}=\pm 20V$ $V_{CE}=0V$	-	-	500	nA
Collector-Emitter Saturation Voltage		$V_{CE(sat)}$	$I_C=75A, V_{GE}=15V$	-	2.1	2.6	V
Gate-Emitter Threshold Voltage		$V_{GE(th)}$	$V_{CE}=5V, I_C=75mA$	4	-	8	V
Input Capacitance		C_{ies}	$V_{CE}=10V, V_{GE}=0V, f=1MHz$	-	7500	-	pF
Switching Time	Rise Time	t_r	$V_{CC}=300V$ $R_L=4\Omega$ $R_G=10\Omega$ $V_{GE}=\pm 15V$	-	0.15	0.3	μs
	Turn-On Time	t_{on}		-	0.25	0.4	
	Fall Time	t_f		-	0.2	0.35	
	Turn-Off Time	t_{off}		-	0.45	0.7	

■ **Free Wheeling Diode Ratings & Characteristics** ($T_C=25^{\circ}C$)

Item		Symbol	Rated Value	Unit
Forward Current	DC	I_F	75	A
	1ms	I_{FM}	150	

Characteristic	Symbol	Test Conditions	Min.	Typ.	Max.	Unit
Peak Forward Voltage	V_F	$I_F=75A, V_{GE}=0V$	-	1.7	2.0	V
Reverse Recovery Time	t_{rr}	$I_F=75A, V_{GE}=-10V$ $di/dt=75A/\mu s$	-	0.15	0.25	μs

■ **Thermal Characteristics** ($T_C=25^{\circ}C$)

Characteristic		Symbol	Test Conditions	Min.	Typ.	Max.	Unit
Thermal Impedance	IGBT	$R_{th(j-c)}$	Junction to Case	-	-	0.38	$^{\circ}C/W$
	Diode			-	-	0.80	



Typical Characteristics

Fig. 1 Output Characteristics (Typical)

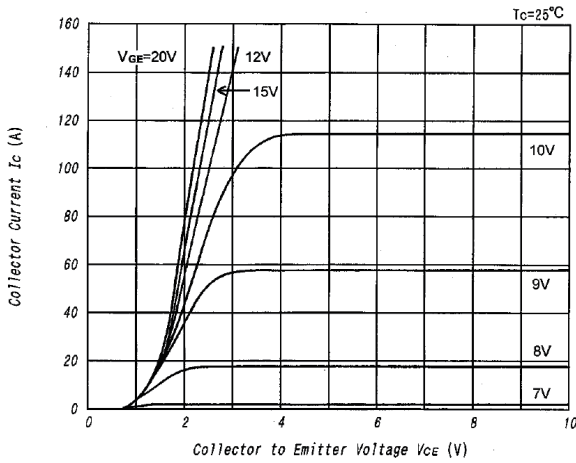

Fig. 2 Collector to Emitter on Voltage vs. Gate to Emitter Voltage (Typical)

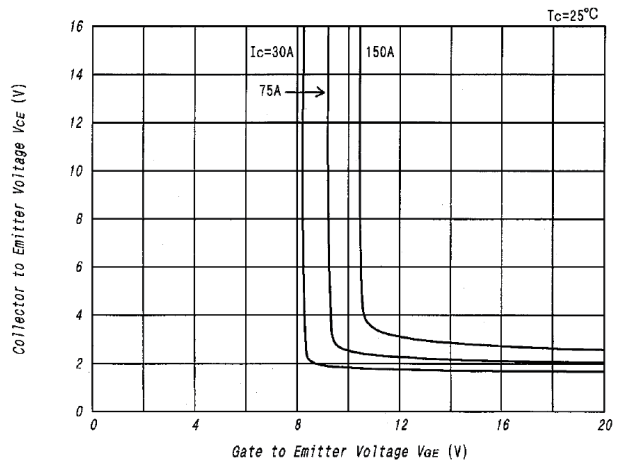

Fig. 3 Collector to Emitter on Voltage vs. Gate to Emitter Voltage (Typical)

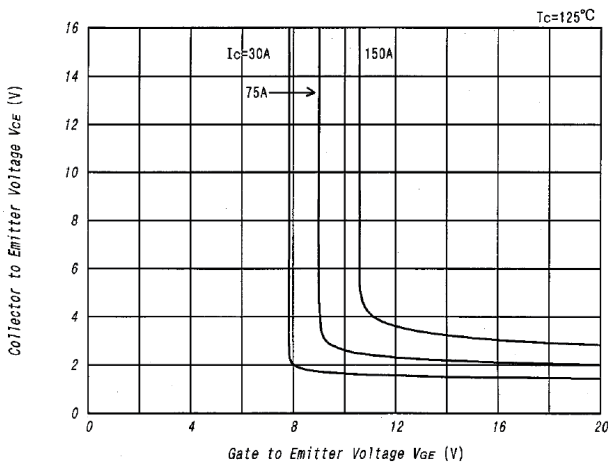

Fig. 4 Gate Charge vs. Collector to Emitter Voltage (Typical)

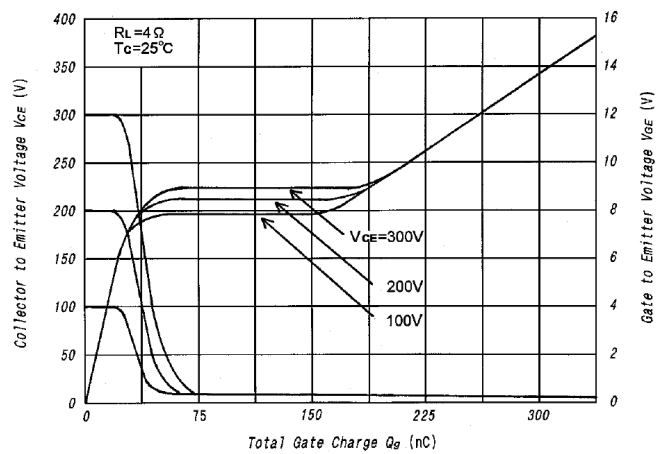

Fig. 5 Capacitance vs. Collector to Emitter Voltage (Typical)

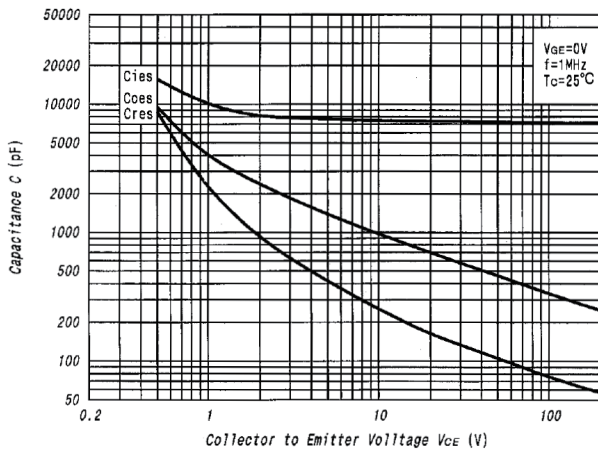
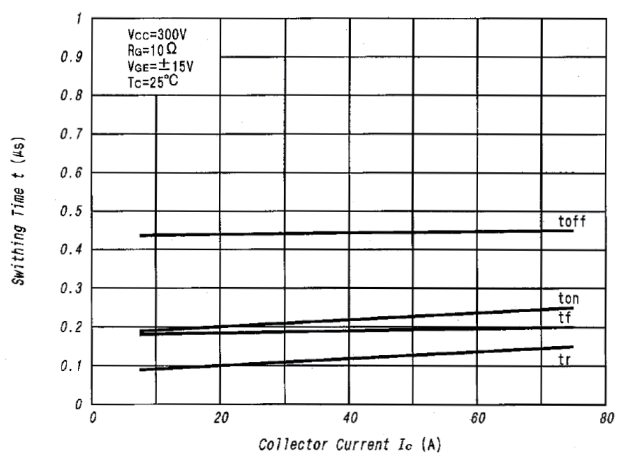

Fig. 6 Collector Current vs. Switching Time (Typical)





Typical Characteristics

Fig. 7 Series Gate Impedance vs. Switching Time (Typical)

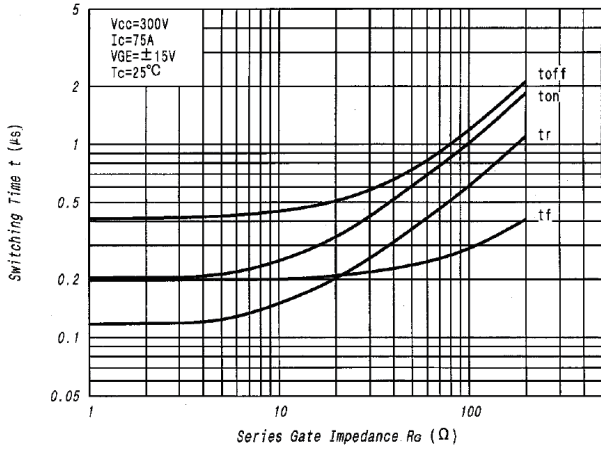

Fig. 8 Forward Characteristics of Free Wheeling Diode (Typical)

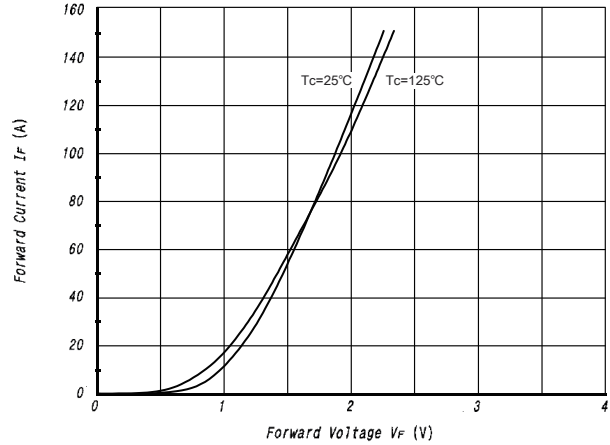

Fig. 9 Reverse Recovery Capacitance (Typical)

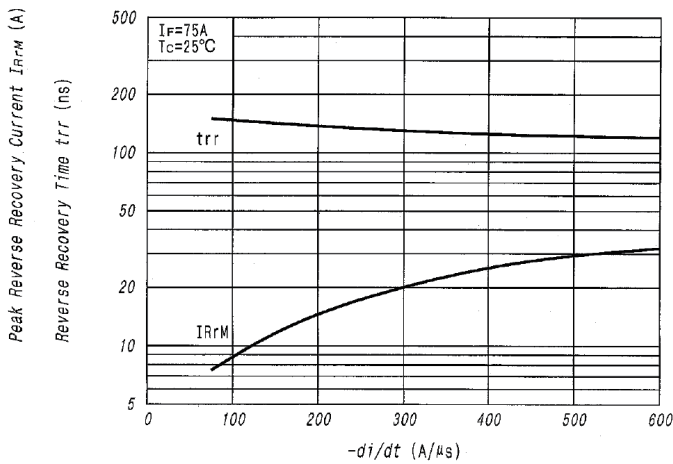

Fig. 10 Reverse Bias Safe Operating Area

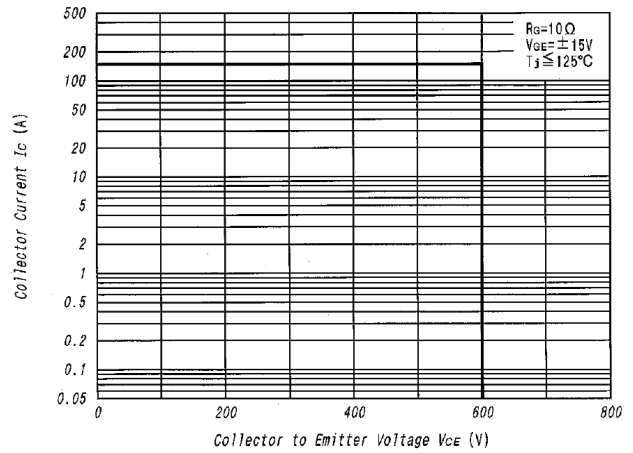
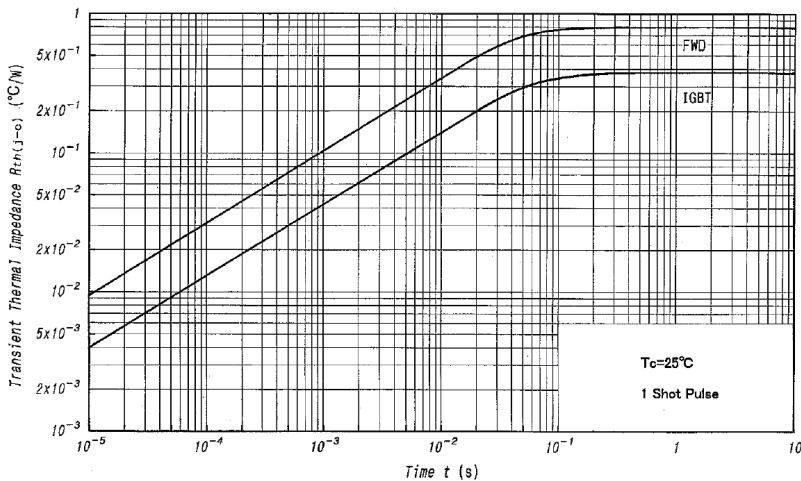

Fig. 11 Transient Thermal Impedance



X-ON Electronics

Largest Supplier of Electrical and Electronic Components

Click to view similar products for [IGBT Modules category](#):

Click to view products by [DACO SEMICONDUCTOR manufacturer](#):

Other Similar products are found below :

[F3L100R07W2E3_B11](#) [F3L15R12W2H3_B27](#) [F3L400R07ME4_B22](#) [F3L400R12PT4_B26](#) [F4-100R12KS4](#) [F4-50R07W2H3_B51](#) [F4-75R12KS4_B11](#) [FB15R06W1E3](#) [FB20R06W1E3_B11](#) [FD1000R33HE3-K](#) [FD300R06KE3](#) [FD300R12KE3](#) [FD300R12KS4_B5](#) [FD400R12KE3](#) [FD400R33KF2C-K](#) [FD401R17KF6C_B2](#) [FD-DF80R12W1H3_B52](#) [FF100R12KS4](#) [FF1200R17KE3_B2](#) [FF150R12KE3G](#) [FF200R06KE3](#) [FF200R06YE3](#) [FF200R12KT3](#) [FF200R12KT3_E](#) [FF200R12KT4](#) [FF200R17KE3](#) [FF300R06KE3_B2](#) [FF300R12KE4_E](#) [FF300R12KS4HOSA1](#) [FF300R12ME4_B11](#) [FF300R12MS4](#) [FF300R17ME4](#) [FF450R12ME4P](#) [FF450R17IE4](#) [FF600R12IE4V](#) [FF600R12IP4V](#) [FF800R17KP4_B2](#) [FF900R12IE4V](#) [MIXA30W1200TED](#) [MIXA450PF1200TSF](#) [FP06R12W1T4_B3](#) [FP100R07N3E4](#) [FP100R07N3E4_B11](#) [FP10R06W1E3_B11](#) [FP10R12W1T4_B11](#) [FP10R12YT3](#) [FP10R12YT3_B4](#) [FP150R07N3E4](#) [FP15R12KT3](#) [FP15R12W2T4](#)