

1F Series

Miniature Toggle Switches

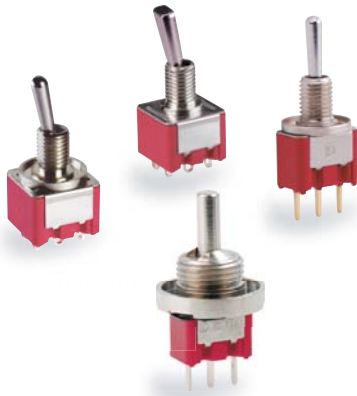

SPECIFICATIONS

CONTACT RATING: AC 125V 6A, AC 250V 3A ,DC 30V 3A

MECHANICAL LIFE: 100,000 make-and-break cycles
DC 10V & 0.1mA.

CONTACT RESISTANCE: 10 mΩ max.

INSULATION RESISTANCE: 500V 500 MΩ min.

DIELECTRIC STRENGTH: 1,000 Vrms min. @sea level.

OPERATING TEMPERATURE: -30°C to 85°C.

WATER-RESISTANCE: 100 make-and-break cycles min at 10 cm depth for T12 actuator.

MATERIALS

CASE: Diallyl phthalate (DAP) (UL94v-0).

ACTUATOR: Brass,chrome plated.

BUSHING: Brass,nickel plated.

HOUSING: Stainless Steel.

SWITCH SUPPORT: Brass,tin plated.

TERMINAL/CONTACT: Brass,with silver or gold plated.



1F
Toggle Switches

HOW TO ORDER

MODEL NO.	ACTUATOR	BUSHING	TERMINATIONS	TERMINAL PLATING	SEAL	RoHS SOLDERING
<div style="display: flex; justify-content: space-around;"> <div style="border: 1px solid black; width: 15px; height: 15px;"></div> <div style="border: 1px solid black; width: 15px; height: 15px;"></div> <div style="border: 1px solid black; width: 15px; height: 15px;"></div> <div style="border: 1px solid black; width: 15px; height: 15px;"></div> </div>	<div style="display: flex; justify-content: space-around;"> <div style="border: 1px solid black; width: 15px; height: 15px;"></div> <div style="border: 1px solid black; width: 15px; height: 15px;"></div> </div>	<div style="display: flex; justify-content: space-around;"> <div style="border: 1px solid black; width: 15px; height: 15px;"></div> <div style="border: 1px solid black; width: 15px; height: 15px;"></div> <div style="border: 1px solid black; width: 15px; height: 15px;"></div> </div>	<div style="display: flex; justify-content: space-around;"> <div style="border: 1px solid black; width: 15px; height: 15px;"></div> <div style="border: 1px solid black; width: 15px; height: 15px;"></div> <div style="border: 1px solid black; width: 15px; height: 15px;"></div> </div>	<div style="border: 1px solid black; width: 15px; height: 15px;"></div>	<div style="border: 1px solid black; width: 15px; height: 15px;"></div>	<div style="border: 1px solid black; width: 15px; height: 15px;"></div>
<p>Model NO.</p> <p>1FS1 SP On-None-On</p> <p>1FS2 SP On-None-Mom.</p> <p>1FS3 SP On- Off -On</p> <p>1FS4 SP Mom.-Off-Mom.</p> <p>1FS5 SP On- Off -Mom.</p> <p>1FD1 DP On-None-On</p> <p>1FD2 DP On-None-Mom.</p> <p>1FD3 DP On- Off -On</p> <p>1FD4 DP Mom.-Off-Mom.</p> <p>1FD5 DP On- Off -Mom.</p>	<p>Actuator</p> <p>T1 10.5 high</p> <p>T2 5.4 high</p> <p>T3 14.2 high</p> <p>T4 16.4 high</p> <p>T5 21.4 high</p> <p>T6 11.5 high</p> <p>T61 21.5 high</p> <p>T12 11.2 high</p>	<p>Bushing</p> <p>B6 8.00 high</p> <p>BA1 9.00 high</p> <p>B9 7.52 high</p>	<p>Terminations</p> <p>M1 Solder Lug</p> <p>M2 PC thru-hole</p>	<p>Terminal plating</p> <p>Q Silver</p> <p>R Gold</p> <p>C Gold over silver</p>	<p>Seal</p> <p>E EPOXY (std)</p> <p>N NO EPOXY</p>	<p>RoHS soldering</p> <p>S RoHS & Lead Free</p>

1F Series

Miniature Toggle Switches

SWITCH FUNCTION

NO. POLES	MODEL NO.	SWITCH FUNCTION			CONNECTED TERMINALS / SCHEMATIC		
		POS.1	POS.2	POS.3	POS.1	POS.2	POS.3
SP	1FS1	ON	NONE	ON	2-3	N/A	2-1
	1FS2	ON	NONE	MOM			
	1FS3	ON	OFF	ON			
	1FS4	MOM	OFF	MOM			
	1FS5	ON	OFF	MOM			
DP	1FD1	ON	NONE	ON	2-3,5-6	N/A	2-1,5-4
	1FD2	ON	NONE	MOM			
	1FD3	ON	OFF	ON			
	1FD4	MOM	OFF	MOM			
	1FD5	ON	OFF	MOM			

MOM=MOMENTARY

ACTUATOR OPTIONS

T1 STD

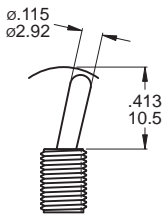

T2

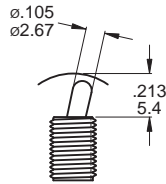

T3

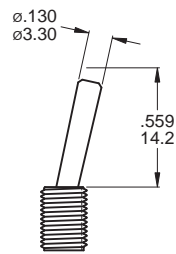

T4

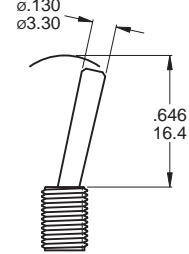

T5

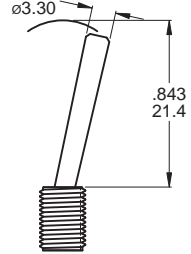

T6 FLATTED WITH ANTIROTATION

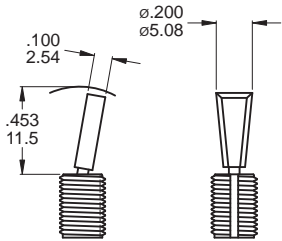

T61

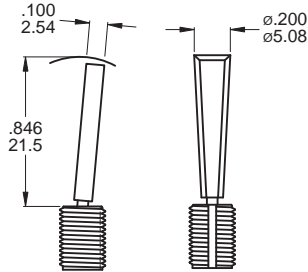

T12

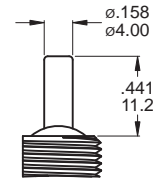

T12 use with BA1 bushing only
*T12 actuator mechanical life 200,000 cycles

T6, T6-1 use with B6 bushing only

TERMINATION OPTIONS

M1 Solder lug

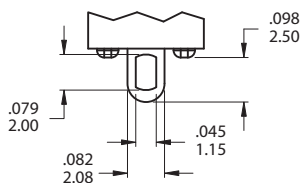

M2 PC Thru - hole

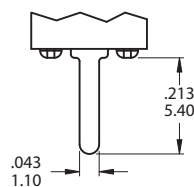

BUSHING OPTIONS

B6 HIGH TORQUE

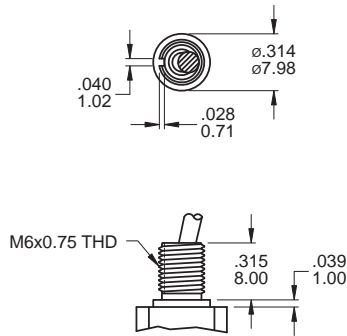

B9 SPLASH PROOF

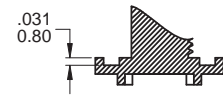
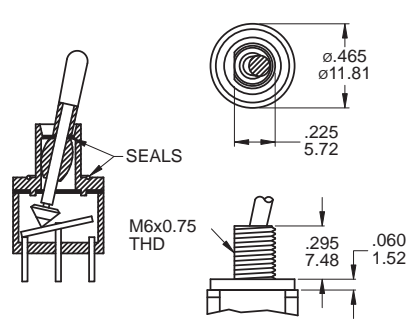

CP-1TEB

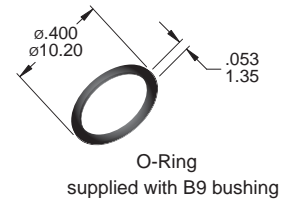

BA1 SPLASH PROOF

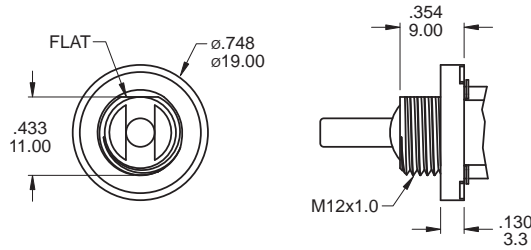

Use with T12 actuators only
BA1 Bear Strength from top of actuator
up to 10kg aside up to 15kg

POLE OPTIONS

SPDT

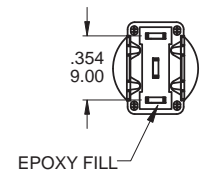
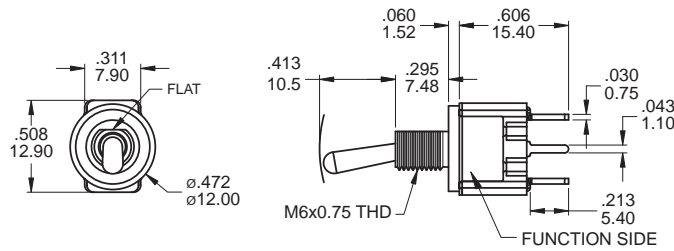

Part No. Shown : 1FS1T1B9M2RES

DPDT

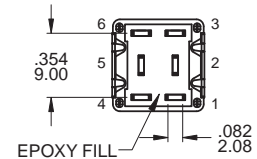
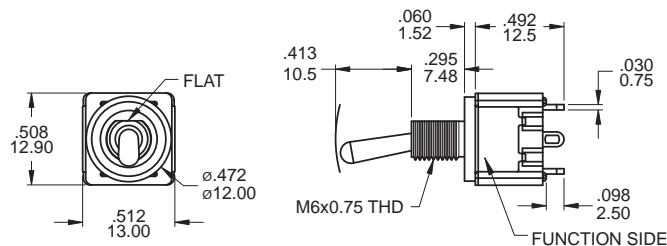

Part No. Shown : 1FD1T1B9M1QES



1F
Toggle Switches

1F Series

Miniature Toggle Switches



1F
Toggle Switches

SPDT

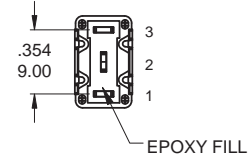
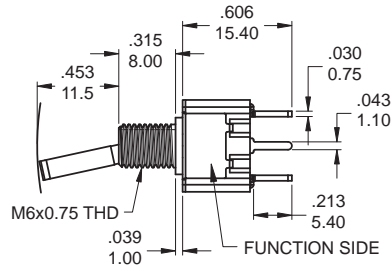
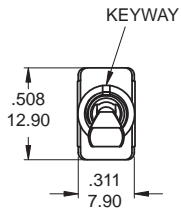

Part No. Shown : 1FS1T6B6M2QES

DPDT

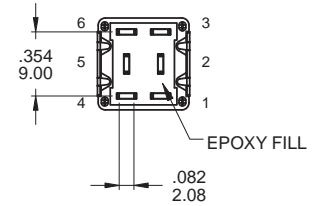
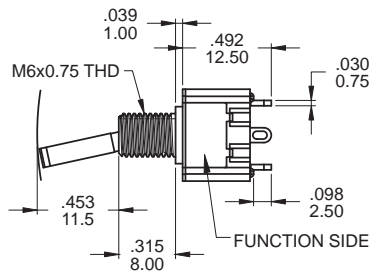
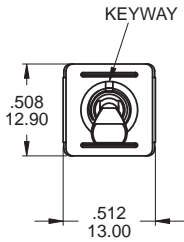

Part No. Shown : 1FD1T6B6M1QES

SPDT

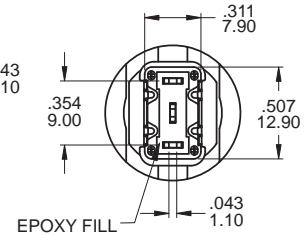
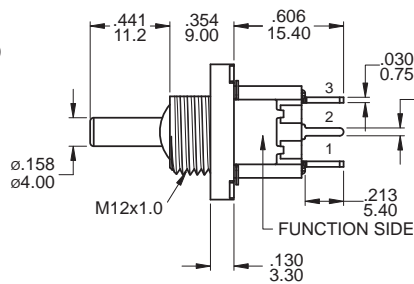
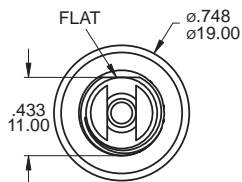

Part No. Shown : 1FS1T12BA1M2QES

DPDT

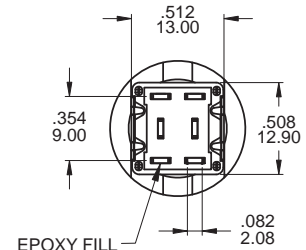
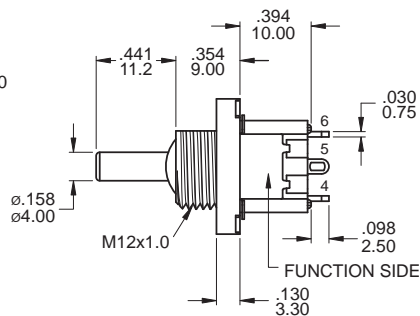
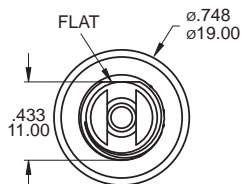

Part No. Shown : 1FD1T12BA1M1QES

HARDWARE

M6x0.75 NUT

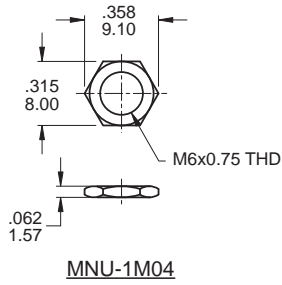

LOCKWASHER

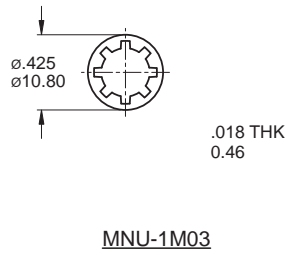

LOCKING RING

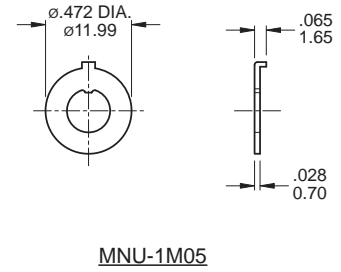

M12x1 NUT

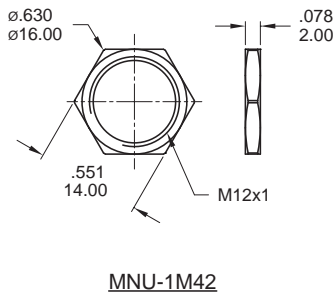

Supplied standard with BA1 bushing

LOCKWASHER

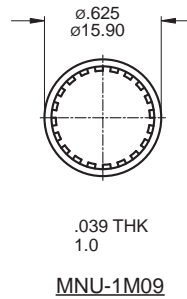

Supplied standard with BA1 bushing

O-RING

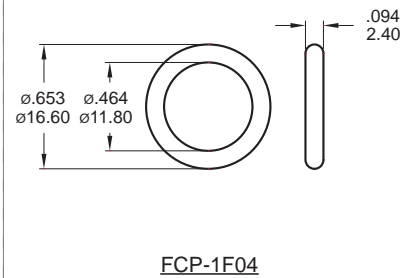

Supplied standard with BA1 bushing

1F
Toggle Switches

CONTACT MATERIAL OPTIONS

	CONTACT PLATING	TERMINAL PLATING	RATINGS
Q	Silver	Q = Silver	6 Amps with resistant load @ 125VAC 3 Amps with resistant load @ 250VAC or 30VDC
C	Gold over Silver	C = Gold over silver	
R	Gold	R = Gold	0.4 Volt - Amps (VA) max. @ 20V max. (AC or DC)

SOLDERING PROCESSES

MANUAL SOLDERING : Use soldering iron of 30 watts, controlled at 350°C approximately 5 seconds while applying solder.

WAVE SOLDERING: Recommended Soldering Temperature: 270 ± 5°C

Duration of Solder Immersion: Max 5 sec. (PCB is 1.6mm in thickness)

X-ON Electronics

Largest Supplier of Electrical and Electronic Components

Click to view similar products for [Toggle Switches](#) category:

Click to view products by [Dailywell](#) manufacturer:

Other Similar products are found below :

[8928K478](#) [8951K2998](#) [8951K3310](#) [8956K1283](#) [8956K1285](#) [8956K1286](#) [8956K1287](#) [8961K155](#) [8A1-C-222](#) [020017-13](#) [0090-0001](#) [0121-0015](#) [CS115W](#) [CS120W](#) [CS1223GY](#) [CS215I](#) [CS8275](#) [637H/25](#) [7101SPDV30BE](#) [7103SDV30BE](#) [7105D](#) [7108P3YAV2BE](#) [71YY50282](#) [7209SY9AQE](#) [7209SYCBE](#) [7300K36](#) [7301SS24484](#) [7303KZQE](#) [7306K36](#) [7503K21](#) [7565K6](#) [7595K6](#) [7691K14](#) [7704K3](#) [8391K108](#) [8811K17](#) [8825K5](#) [8835K3](#) [8858K44](#) [8E4011](#) [1202W](#) [A201SCWZB04](#) [A207SYCB04](#) [A208J61ZQ0004](#) [A221T1TCQ](#) [A323S1CWZQ](#) [1201W](#) [1203W](#) [12156AX408](#) [1221W](#)