

## SPECIFICATIONS

**CONTACT RATING:** Dependent upon contact material See Page 85.

**MECHANICAL LIFE:** 30,000 make-and-break cycles.

**CONTACT RESISTANCE:** 10 mΩ max. initial @ 2-4VDC  
100mA for both silver and gold plated contacts.

**INSULATION RESISTANCE:** 1,000 MΩ min.

**DIELECTRIC STRENGTH:** 1,000 Vrms min. @sea level.

**OPERATING TEMPERATURE:** -40°C to 85°C.

## MATERIALS

**CASE:** Diallyl phthalate (DAP) (UL94v-0).

**HOUSING:** Stainless Steel.

**ACTUATOR:** Nylon, black std.

**CONTACT/TERMINALS:** Copper alloy, with silver or gold plated.

**TERMINAL SEAL:** Epoxy.



## HOW TO ORDER

MODEL NO.    ACTUATOR    ACTUATOR COLOR    MOUNTING EARS    TERMINATIONS    TERMINAL PLATING    SEAL    RoHS SOLDERING

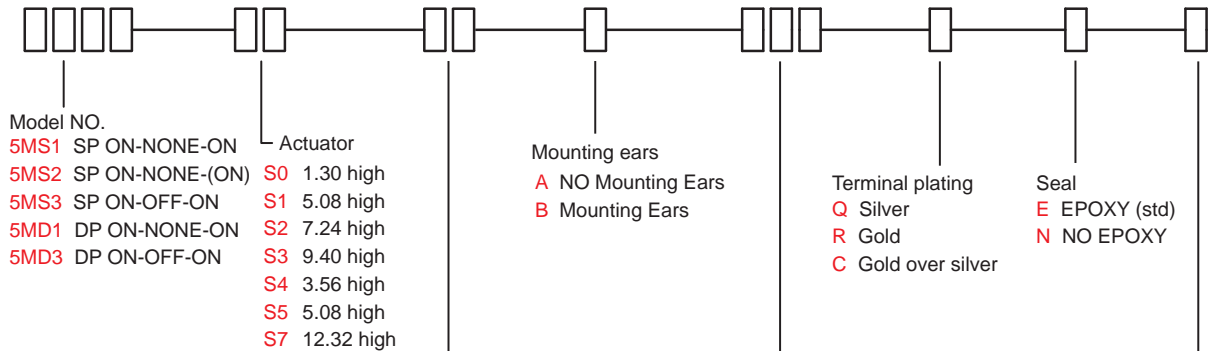

Actuator color	
ITEM NO	COLOR
01	White
02	Black (Std)
03	Red
04	Orange
05	Yellow
06	Green
07	Blue
08	Brown
09	Gray

\* Besides standard color, other colors need to check stocks available.

Terminations	
<b>M1</b>	Solder Lug
<b>M2</b>	PC thru-hole
<b>M3</b>	Quick Connect
<b>M51</b>	18.70 high, wire wrap
<b>M52</b>	24.20 high, wire wrap
<b>M53</b>	10.55 high, wire wrap
<b>M54</b>	26.97 high, wire wrap
<b>M6</b>	Right angle, PC thru-hole
<b>M7</b>	Vertical right angle, PC thru-hole
<b>VS2</b>	V-bracket , Not applicable for the actuator of S5

RoHS soldering  
**S** RoHS & Lead Free



5M  
Slide Switches

# 5M Series

Slide Switches

## SWITCH FUNCTION

NO. POLES	UL/CSA MODEL NO.	MODEL NO.	SWITCH FUNCTION			CONNECTED TERMINALS / SCHEMATIC		
			POS.1	POS.2	POS.3	POS.1	POS.2	POS.3
SP	Q1511	5MS1	ON	NONE	ON	2-1	N/A	2-3
	Q1512	5MS2	ON	NONE	(ON)	2 (COMM)		2 (COMM)
	Q1513	5MS3	ON	OFF	ON	1 • 2 (COMM) • 3	OPEN	1 • 2 (COMM) • 3
DP	Q1521	5MD1	ON	NONE	ON	2-1,5-4	N/A	2-3,5-6
	Q1523	5MD3	ON	OFF	ON	1 • 2 (COMM) • 3 4 • 5 • 6	OPEN	1 • 2 (COMM) • 3 4 • 5 • 6

( )=MOMENTARY

## POLE OPTIONS

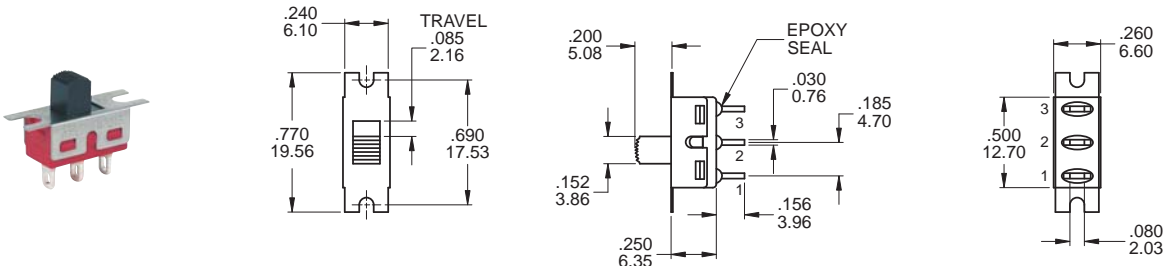

### SPDT

Part No. Shown : 5MS1S102BM1QES

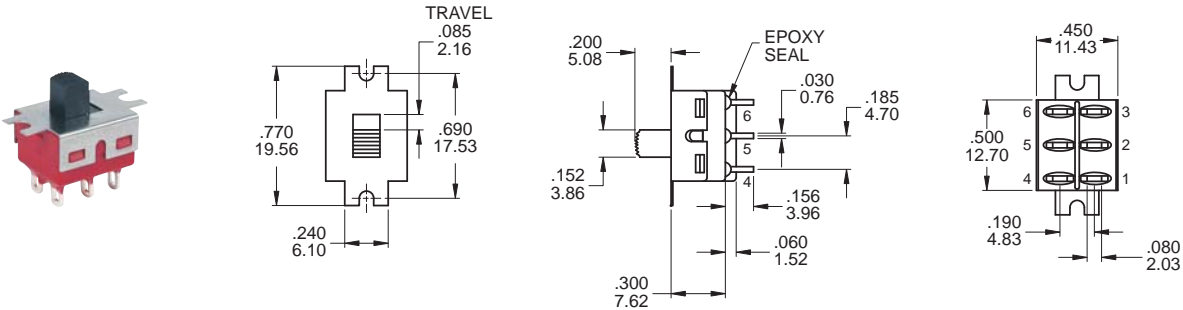

### DPDT

Part No. Shown : 5MD1S102BM1QES

## ACTUATOR OPTIONS

### S1 STD

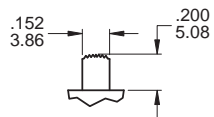

### S2

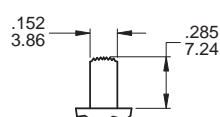

### S0 Only for S1,S2,D1,D3 model type

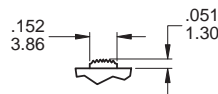

### FRONT

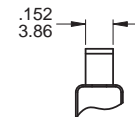

### ▲ S5 Only DPDT

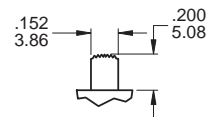

### S3

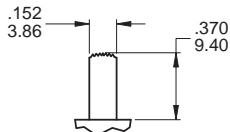

### S4

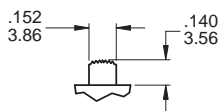

### S7

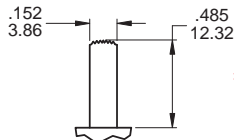

For S0,S1,S2,S3,S4 actuator

### FRONT

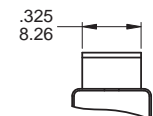

\* Subtract .014(0.36) from Actuator height for M6, M7 P.C. mounting option.

TERMINATION OPTIONS

M1 Solder lug

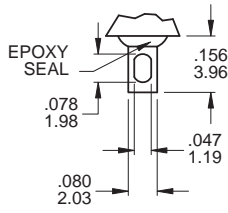

.030(0.76) THK.

M2 PC Thru-hole

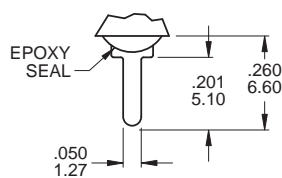

.030(0.76) THK.

M3 Quick connect

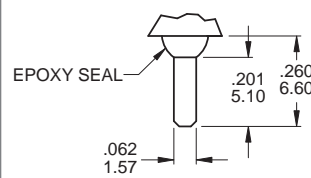

THK .030(0.76)

M5 Wire Wrap

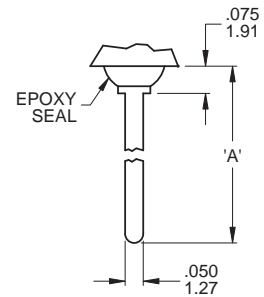

THK .030(0.76)

OTHER TERMINATION OPTIONS

- M6 Right angle P.C. Mount
- M7 Right angle P.C. Mount
- VS2 Vertical bracket P.C. Mount

OPTION CODE	DIM. 'A'
M51	.736 (18.70)
M52	.953 (24.20)
M53	.415 (10.55)
M54	1.062 (26.97)

M6

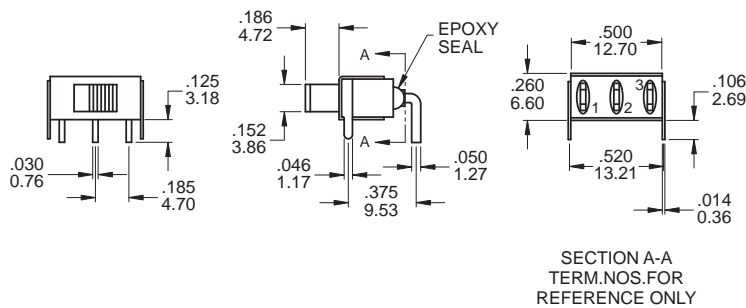

P.C. MOUNTING

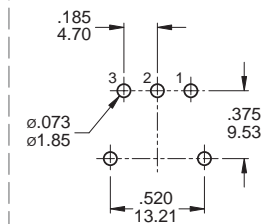

SPDT

Part No. Shown : 5MS1S102AM6QES

M6

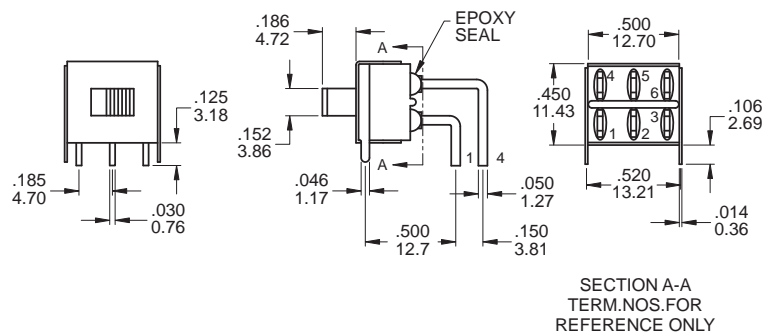

P.C. MOUNTING

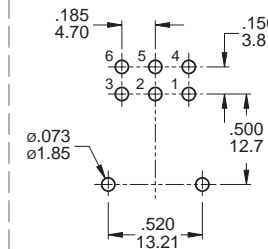

DPDT

Part No. Shown : 5MD1S102AM6QES



5M  
Slide Switches

# 5M Series

Slide Switches

M7

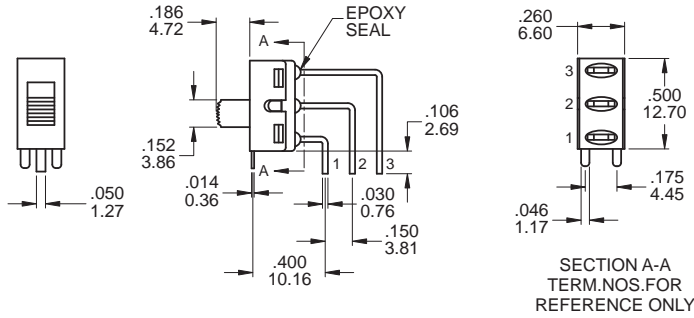

P.C. MOUNTING

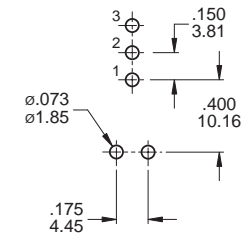

SPDT

Part No. Shown : 5MS1S102AM7QES

M7

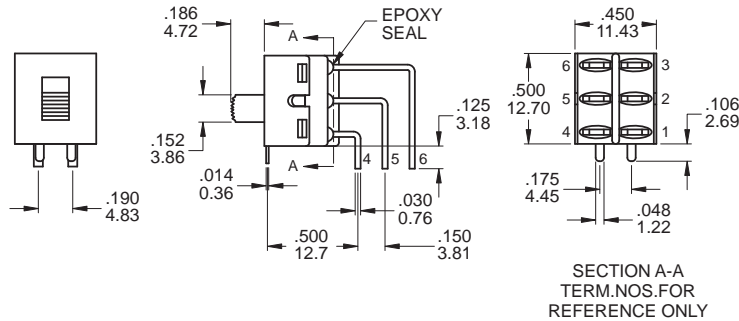

P.C. MOUNTING

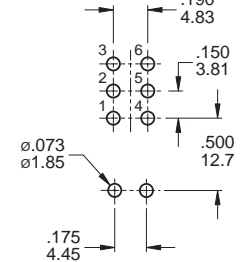

DPDT

Part No. Shown : 5MD1S102AM7RES

VS2

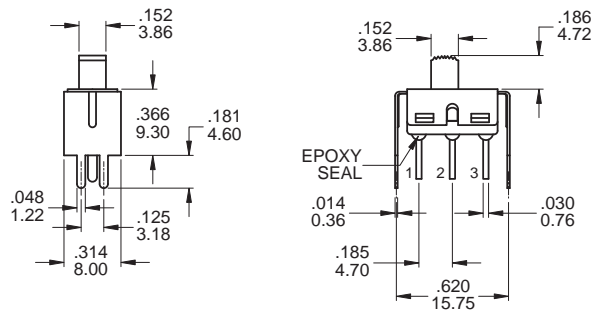
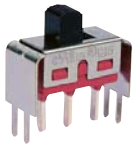

P.C. MOUNTING

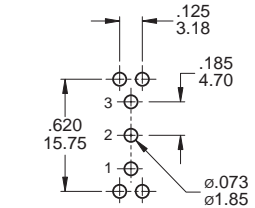

SPDT

Part No. Shown : 5MS1S102AVS2QES

VS2

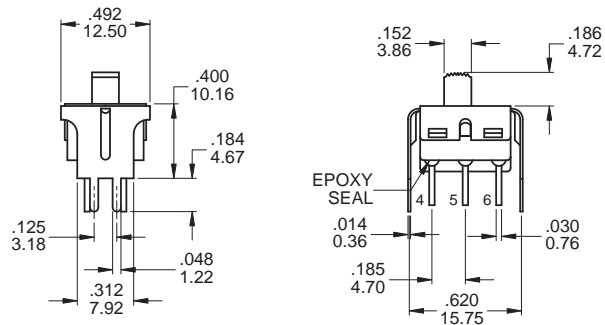
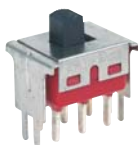

P.C. MOUNTING

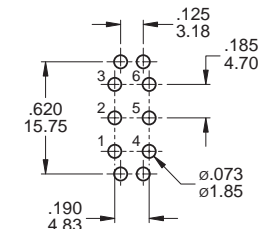

DPDT

Part No. Shown : 5MD1S102AVS2QES

5M  
Slide Switches



**MOUNTING EARS / PANEL MOUNT**

**MOUNTING EARS**

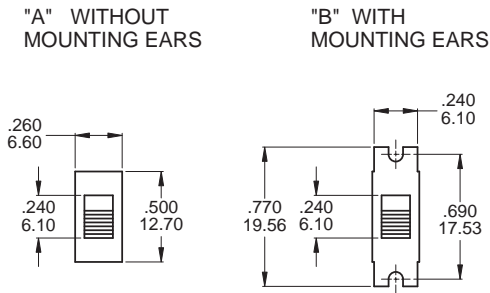

**THREE POSITIONS ONLY**

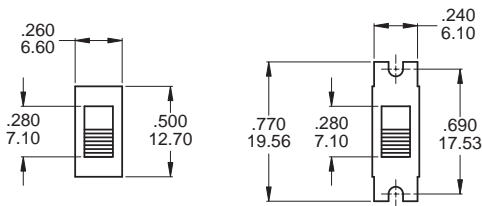

**PANEL MOUNTING**

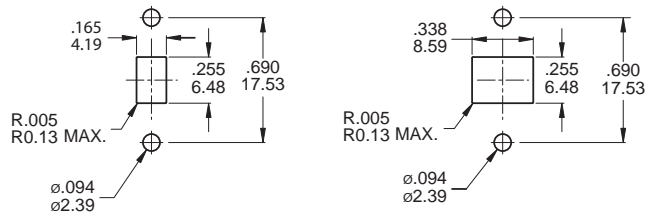

For S0,S1,S2,S3,S4 actuator

For S5 actuator only

**THREE POSITIONS ONLY**

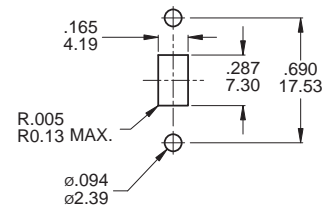

For S0,S1,S2,S3,S4 actuator



5M  
Slide Switches

**CONTACT MATERIAL OPTIONS**

	CONTACT PLATING	TERMINAL PLATING	RATINGS
<b>Q</b>	Silver	Silver	5 Amps with resistant load @ 120VAC or 28VDC
<b>C</b>	Gold over Silver	Gold over silver	
<b>R</b>	Gold	Gold	0.4 Volt - Amps ( VA ) max. @ 20V max. ( AC or DC )

**SOLDERING PROCESSES**

**MANUAL SOLDERING :** Use soldering iron of 30 watts, controlled at 350°C approximately 5 seconds while applying solder.

**WAVE SOLDERING :** Recommended Soldering Temperature : 270 ± 5°C

Duration of Solder Immersion : Max 5sec. (PCB is 1.6mm in thickness)

## X-ON Electronics

Largest Supplier of Electrical and Electronic Components

*Click to view similar products for [Slide Switches](#) category:*

*Click to view products by [Dailywell](#) manufacturer:*

Other Similar products are found below :

[6-1437581-1](#) [M43R](#) [MHS123K15D](#) [MHS133K](#) [MHSS1104A](#) [MMD](#) [GH49S010001](#) [MSS12A](#) [EPS1PC1](#) [1825074-1](#) [1825160-3](#) [1825167-2](#)  
[1825289-7](#) [K232CB](#) [25139NLDB](#) [25449NAH](#) [SLB1240R45](#) [1825078-1](#) [1825080-4](#) [1825269-1](#) [1825270-2](#) [STS141RA04](#) [T2215BEN506](#)  
[GH46P000001](#) [GH46W000001](#) [GH49P010001](#) [25339NA](#) [M42A](#) [TG36P000000](#) [TG36P000050](#) [AYZ0202AG](#) [47227LFE](#) [49331L](#) [50208L](#)  
[L203091MS02Q](#) [4-1437581-7](#) [X2225CR-437W](#) [49329L](#) [1101M1S3ZB8E2](#) [1-1437581-1](#) [MSS2225G04](#) [TG39W000000](#) [1825075-1](#)  
[MSS42G](#) [TG36WS80065](#) [T105S1CWZBE](#) [SLB124145](#) [SLB1280R5](#) [SLB1340R45](#) [25136NLDB](#)