

SP86N(L) Series

Pushbutton Switches

HOW TO ORDER

SP86N
SP86L (Latching)

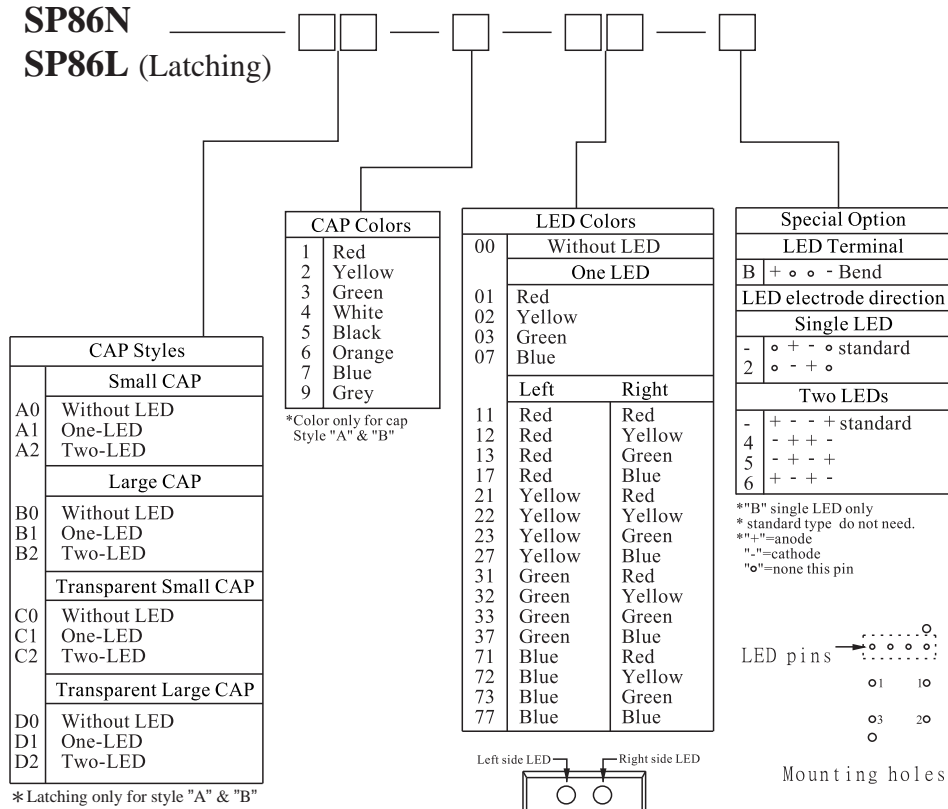

EXAMPLE : SP86N-B1-1-01
SP86N pushbutton switch large red cap single red LED.

DIMENSION

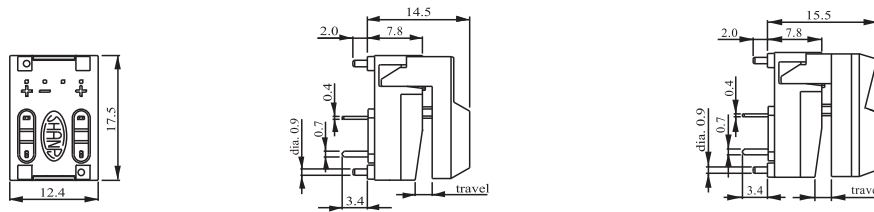

SP86N(L)
Pushbutton Switches



General Specifications	
Circuit	:SPDT
Current Rating	:12 mA.
Voltage Rating	:24 V DC
Contact Resistance	:50 m Ohm Max(initial)
Insulation Resistance	:100 M Ohm Min
Operating Force	:170 gf+50 gf
Total Travel	:2.5 mm +0.5 mm
Operating Life	:1,000,000 Cycles Min.
Solder Specifications	:260 deg for 3 seconds
Operating Temperature	:-10 deg~+60 deg
Function	:Momentary
LED Rating	:See the table below

Material	
Cap	:Acrylonitrile Butadine Styrene (ABS)
Case	:Polyamide (PA)
Fixed Support	:Stainless steel wire
Terminal	:Phosphor bronze (PBS) with gold plating
Moving Contact	:Phosphor bronze (PBS) with gold plating
Spring	:Piano wire
LED	:3mm Diameter LED Lamp

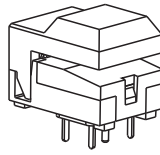
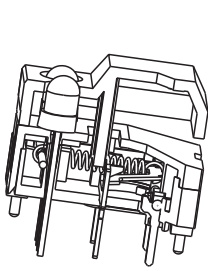

A & B cap type dimension

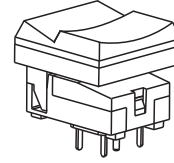

C & D cap type dimension

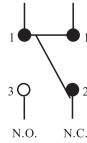

(SPDT)
Contact Configuration
SP86N Type

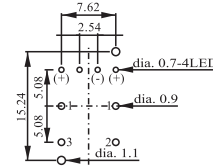

P.C.B. Mounting Holes

Dimension unit in mm

LED CHARACTERISTICS

The electrical specifications shown are determined at a basic temperature of 25 C. If the source voltage exceeds the rated voltage of LED, a ballast resistor must be connected in series with the LED.

LED Characteristics

Parameter	Symbol(Unit)	Red	Yellow	Green	Blue
Forward Voltage	V_F (V)	2.0	2.1	2.2	3.5
Forward Current	I_F (mA)	20	20	20	20
Permissible loss	P_D (mW)	80	80	80	120
Luminous Intensity	I_V (mcd)	60	50	60	600
Peak Wave Length	λ_p (nm)	635	585	568	470
Reverse Voltage	V_R (V)	5			
Reverse Current) $V_R=5V$	(μA)	100			
Solder ng Temperature	(degree)	260 for 5 Seconds			



Attention: LED are electrostatic sensitive devices

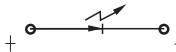

Cap Style

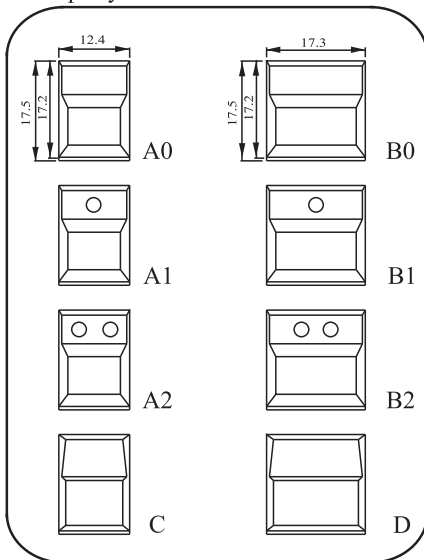

Paperboard

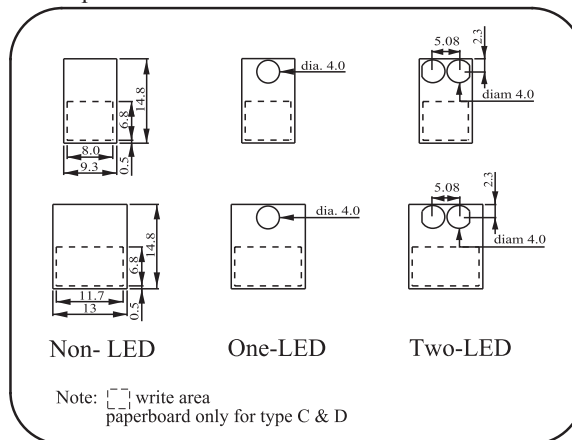

Dimension unit in mm

X-ON Electronics

Largest Supplier of Electrical and Electronic Components

Click to view similar products for [Pushbutton Switches](#) category:

Click to view products by [Dailywell](#) manufacturer:

Other Similar products are found below :

[8940K2012](#) [LW1L-M1C10V-A](#) [LW1L-M1C70-A](#) [LW2L-A1C20M-GD](#) [LW2L-M1C20M-A](#) [60324L](#) [M22-D-R-GB0/K11](#) [M7E-HRN2](#)
[67021K512](#) [67081K512X](#) [701PB580](#) [7199K101](#) [810K12910](#) [810KSV30B](#) [MML21EA2ADK](#) [MML21KA3ABK](#) [MML23KA3AC05K-001](#)
[MML23KW3AA01W](#) [8418K2](#) [8442K3](#) [8450K1](#) [860K11911T01A](#) [861901](#) [861K11911T01A07](#) [861K13810T00A14](#) [861K13911](#)
[8646AB6X718UL](#) [8646ABUL](#) [9001KXRK](#) [907AYY100](#) [PMHD155A1](#) [9533CD4+U574+U4922](#) [95-414.000](#) [99-450.837](#) [99-453.837](#)
[PV3H2B0NN-341](#) [1203MRA](#) [A22NZBGANGA](#) [A22NZBNANGA](#) [A22NZMPATRA](#) [A2PMA1X03EC56](#) [A3A-5123-02](#) [A3A-7140](#) [A3A-7310](#) [A3A-7340](#) [A3U-TMW-A2C-5M](#) [A595](#) [12037A2ULCSA](#) [ABD122N-B](#) [1211390004](#)