

Data sheet

CI-TI™ Contactors and Motor Starters

Type CI 6 - 50

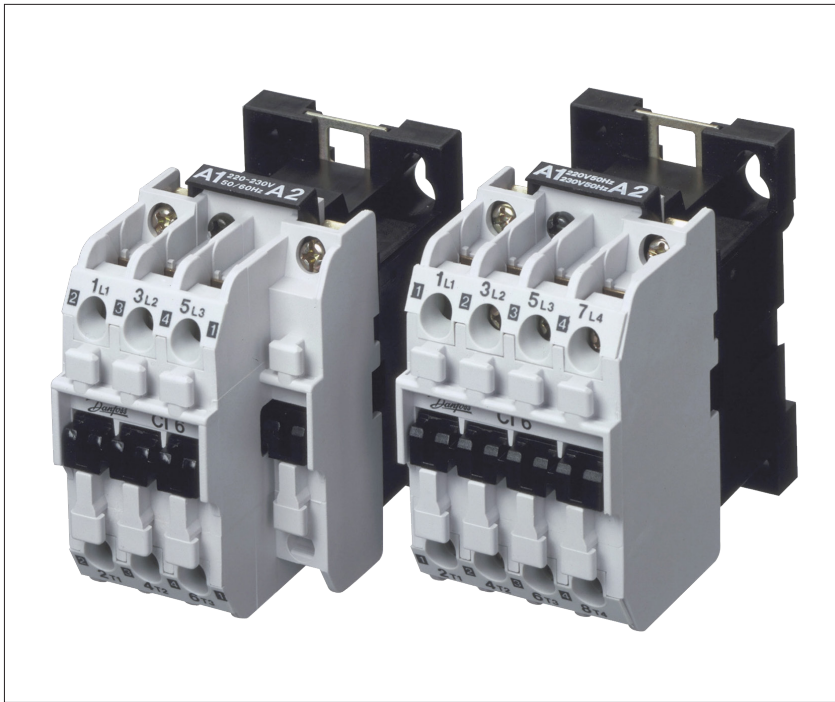

CI-TI™ contactors and motor starters provide trouble-free switching and maximum protection for costly motors and other electrical equipment.

The components are compact, easy to install and extremely reliable.

They are designed to meet demanding requirements, based on comprehensive application experience.

More than sixty years of manufacturing experience ensure that our contactors and motor starters stand out with regards to quality and long life.

Contactors CI 6 – CI 50 for AC coil voltage (no built-in auxiliary contacts)

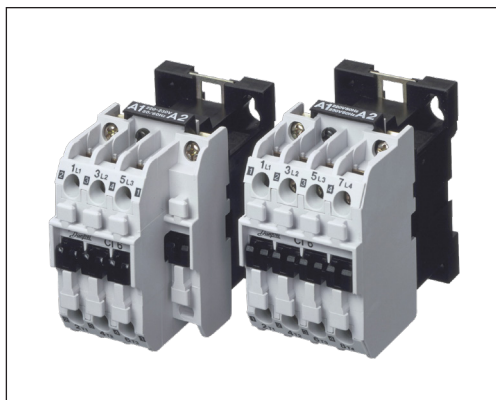

Danfoss contactors CI 6 – CI 50 cover the power range 2.2 – 25 kW.

CI 6 is built up as a combined contactor/control relay.

CI 9 DC – CI 30 DC and CI 9 EI – CI 30 EI are contactors for DC coil voltage within the power range 2.2 – 15 kW. The range CI 9 EI – CI 30 EI has built-in interface relay for PLC application with 24 V DC output.

Accessories include a wide selection of clip-on auxiliary contact blocks and timers, interface modules and RC links.

The CI 6 – CI 50 range also includes thermal overload relays for protection of squirrel-cage motors.

Type	Main circuit							Auxiliary contacts	Code no. ¹⁾
	AC-3 load			$I_{th}^{(4)}$ (AC-1) Open [A]	$I_{the}^{(5)}$ (AC-1) Encl. [A]	Max. $I_{th}^{(6)}$ (AC-1) Open [A]	Main contacts (make) Number		
	U_e 220 – 240 V [kW]	U_e 380 – 690 V [kW]	I_e [A]					Add-on options Number	
CI 6 ²⁾	1.5	2.2	6	20	16	–	3	1 – 4	037H0015
	1.5	2.2	6	20	16	–	4	1 – 4	037H0018
CI 9	2.2	4.0	9	25	16	–	3	1 – 4	037H0021
	2.2	4.0	9	25	16	–	4	1 – 4	037H0022
CI 12	3.0	5.5	12	25	20	–	3	1 – 4	037H0031
	3.0	5.5	12	25	20	–	4	1 – 4	037H0032
CI 15	4.0	7.5 ³⁾	16	25	20	30	3	1 – 4	037H0049
	4.0	7.5 ³⁾	16	25	20	30	4	1 – 4	037H0050
CI 16	4.0	7.5	16	40	25	45	3	1 – 4	037H0041
CI 20	5.5	10.0	20	40	25	45	3	1 – 4	037H0045
CI 25	5.5	11.0	25	40	25	45	3	1 – 4	037H0051
CI 30	8.5	15.0	32	40	30	50	3	1 – 4	037H0055
CI 32	8.5	15.0 ³⁾	32	63	63	–	3	1 – 4	037H0061
CI 37	10.0	18.5 ³⁾	37	80	63	–	3	1 – 4	037H0056
CI 45	11.0	22.0 ³⁾	45	80	80	90	3	1 – 4	037H0071
CI 50	15.0	25.0 ³⁾	52	80	80	90	3	1 – 4	037H0080

¹⁾ Suffix defining coil voltage/frequency must be added to the Danfoss code no. (see table on page 4).

²⁾ AC-15 operation: max. 500 VA / 6A

³⁾ U_e max.: 500 V

⁴⁾ The thermal current value I_{th} represents the maximum load at 40 °C, which corresponds to installing the contactor in air (open).

⁵⁾ The thermal current value I_{the} represents the maximum load at 60 °C, which corresponds to installing the contactor inside an enclosure.

⁶⁾ Heat-resistant leads (min. 75 °C) must be used.

Contactors CI 6 – CI 30 for AC coil voltage with AMP connections

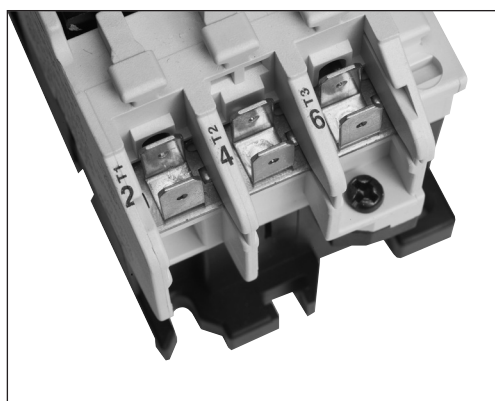

The CI 6 – CI 30 contactors are also available with AMP connections in main circuits. Coils are equipped with standard screw connections.

This version can be especially useful in the applications where contactors are installed in the large number of standardized machines (welding machines or A/C units).

Type	Main circuit						Code no. ^{1) 2)}
	AC-3 load			AC-1 load			
	U _e 220 – 240 V [kW]	U _e 380 – 690 V [kW]	I _e [A]	I _{th} ⁴⁾ Open [A]	I _{the} ⁵⁾ Encl. [A]	max. I _{th} ⁶⁾ (make) [A]	
CI 6 ³⁾	1.5	2.2	6	20	16	–	037H4015
CI 9	2.2	4.0	9	25	16	–	037H4021
CI 12	3.0	5.5	12	25	20	–	037H4033
CI 15	4.0	7.5	15	25	20	30	037H4049
CI 16	4.0	7.5	16	40	25	45	037H4041
CI 20	5.5	10.0	20	40	25	45	037H4060
CI 25	5.5	11.0	25	40	25	45	037H4051
CI 30	8.5	15.0	32	40	30	50	037H4055

¹⁾ Suffix defining coil voltage / frequency must be added to the Danfoss code no. (see table on page 4).

²⁾ The minimum order size is 30 pcs. for CI 6 to CI 15 and 25 pcs. for CI 16 to CI 30 in industrial packs. Industrial packs should be ordered as **037H40xxxx**.

³⁾ AC-15 Operation: max. 500 VA / 6A

⁴⁾ The thermal current value I_{th} represents the maximum load at 40 °C, which corresponds to installing the contactor in air (open).

⁵⁾ The thermal current value I_{the} represents the maximum load at 60 °C, which corresponds to installing the contactor inside an enclosure.

⁶⁾ Heat-resistant leads (min. 75 °C) must be used.

AC coil voltages and coils for CI 6 – CI 30

Coil voltage *)	Suffix no.	Code no.
24 V, 50 – 60 Hz	13	037H6484 ¹⁾
24 V, 50 Hz / 29 V, 60 Hz	16	037H6462
42 V, 50 Hz / 50 V, 60 Hz	17	037H6463
110 V, 50 Hz / 110 – 120 V, 60 Hz	23	037H6487 ¹⁾
208 – 230 V, 60 Hz	28	037H6450 ²⁾
220 – 230 V, 50 Hz / 220 V, 60 Hz	32	037H6488 ¹⁾
220 – 240 V, 50 Hz	31	037H6472
380 – 400 V, 50 Hz / 440 V, 60 Hz	37	037H6478
415 V, 50 Hz / 500 V, 60 Hz	38	037H6479
500 V, 50 Hz / 600 V, 60 Hz	94	037H6481

AC coil voltages and coils for CI 32 – CI 50

Coil voltage *)	Suffix no.	Code no.
24 V, 50 – 60 Hz	13	037H6084 ¹⁾
42 V, 50 Hz / 50 V, 60 Hz	17	037H6063
110 V, 50 Hz / 110 – 120 V, 60 Hz	23	037H6087 ¹⁾
208 – 230 V, 60 Hz	28	037H6050 ²⁾
220 – 230 V, 50 Hz / 220 V, 60 Hz	32	037H6088 ¹⁾
220 – 230 V, 50 Hz	31	037H6072
380 – 400 V, 50 Hz / 440 V, 60 Hz	37	037H6078
415 V, 50 Hz / 500 V, 60 Hz	38	037H6079
500 V, 50 Hz / 600 V, 60 Hz	94	037H6081

*) Standard coil voltage from -15% – 10%.

¹⁾ Double frequency coil: voltage range $\pm 10\%$.

Continuous operation: ambient temperature max. 55 °C, non-enclosed

Intermittent operation: energized for 30 min/hour: ambient temperature max. 65 °C

²⁾ Operating conditions and tolerances as for double frequency coils.

Correct ordering of contactors

Example: CI 9 with four main contacts and 24 V, 50 Hz coil voltage.

Select one of the following two forms of ordering:

1. Danfoss code no. + Suffix no.:

037H002216

or

2. Danfoss code no. + coil voltage/frequency:

037H0022, 24 V/50 Hz

**Interface contactors
CI 9 EI – CI 30 EI (no built-in
auxiliary contacts)**

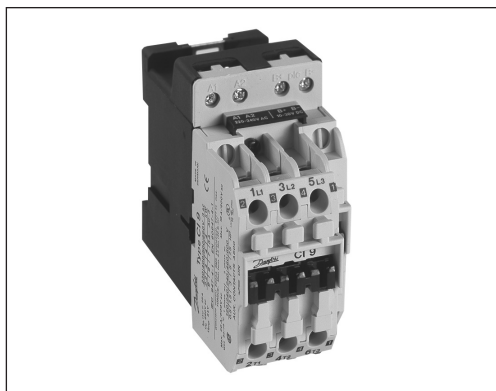

Contactors CI 9 EI – CI 30 EI cover the power range 4 – 15 kW.
The operation of the coil is controlled by an electronic circuit.
The range CI 9 EI – CI 30 EI has a built-in interface relay for PLC application with 24 V DC output.
Accessories include a wide selection of clip-on auxiliary contact blocks and timers.
The CI 9 EI – CI 30 EI range also includes thermal overload relays for protection of squirrel-cage motors.

Type	Main circuit					Control circuit		Code no.
	AC-3 load			AC-1 load		Coil	PLC ⁵⁾	
	U _e 220 – 240 V [kW]	U _e 380 – 690 V [kW]	I _e [A]	I _{th} ¹⁾ Open [A]	I _{the} ²⁾ Encl. [A]	A1 – A2 [V]	B+ - B- [V]	
CI 9 EI 24	2.2	4.0	9	25	16	24 DC	24 DC	037H801166
CI 9 EI 230	2.2	4.0	9	25	16	220 – 240 AC ⁴⁾	24 DC	037H806166
CI 15 EI 24	4.0	7.5 ³⁾	15	25	20	24 DC	24 DC	037H801366
CI 15 EI 230	4.0	7.5 ³⁾	15	25	20	220 – 240 AC ⁴⁾	24 DC	037H806366
CI 25 EI 24	5.5	11.0	25	40	25	24 DC	24 DC	037H801666
CI 25 EI 230	5.5	11.0	25	40	25	220 – 240 AC ⁴⁾	24 DC	037H806666
CI 30 EI 24	8.5	15.0	32	40	30	24 DC	24 DC	037H801766
CI 30 EI 230	8.5	15.0	32	40	30	220 – 240 AC ⁴⁾	24 DC	037H806766

- ¹⁾ The thermal current value I_{th} gives the maximum load at 40 °C, which corresponds to installing the contactor in air (open).
- ²⁾ The thermal current value I_{the} gives the maximum load at 60 °C, corresponding to installing the contactor inside an enclosure.
- ³⁾ U_e max 500 V
- ⁴⁾ Coils are dual frequency coils
- ⁵⁾ Cable length from PLC to B+ and B- max. 50 m because of risks of interference.

Ordering example
CI 9 EI with 230 V AC coil
and 24 V DC PLC interface:

Danfoss code number:
037H8061

(Type: CI 9 EI230)

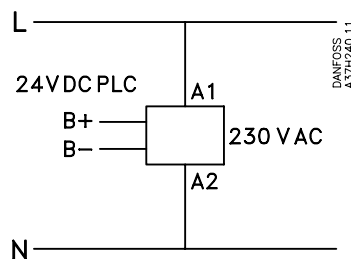

Contactors CI 9 DC – CI 30 DC (no built-in auxiliary contacts)



Contactors CI 9 DC – CI 30 DC cover the range 4 – 15 kW.

The operation of the coil is controlled by an electronic circuit.

The control voltage is 12 V DC or 24 V DC.

A typical application is transport cooling.

Accessories include a wide selection of clip-on auxiliary contact blocks and timers.

The CI 9 DC – CI 30 DC range also includes thermal overload relays for protection of squirrel-cage motors.

Type	Main circuit					Control circuit	Code no.
	AC-3 load			AC-1 load		Coil ⁴⁾	
	U _e 220 – 240 V [kW]	U _e 380-690 V [kW]	I _e [A]	I _{th} ¹⁾ Open [A]	I _{the} ²⁾ Encl. [A]		
CI 9 DC 24	2.2	4.0	9	25	16	24 DC	037H807166
CI 15 DC 12	4.0	7.5 ³⁾	16	25	20	12 DC	037H800366
CI 15 DC 24	4.0	7.5 ³⁾	16	25	20	24 DC	037H807366
CI 25 DC 24	5.5	11.0	25	40	25	24 DC	037H807666
CI 30 DC 24	8.5	15.0	32	40	30	24 DC	037H807766

¹⁾ The thermal current value I_{th} gives the maximum load at 40 °C, which corresponds to installing the contactor in air (open).

²⁾ The thermal current value I_{the} gives the maximum load at 60 °C, corresponding to installing the contactor inside an enclosure.

³⁾ U_e max 500 V.

⁴⁾ Standard coil voltage from -15% – 10%.

Ordering example
CI 15 DC with 12 V DC coil:

Danfoss code number:
037H800366

(Type: CI 15 DC 12)

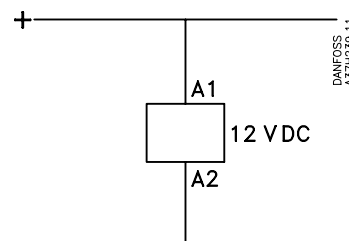

Auxiliary contact blocks CB for CI 6 – CI 50



Type	Contact function	Load				Colour code	Code no.
		I _e (AC - 15) [A]	I _{th} ¹⁾ (AC-1) Open [A]	I _{the} ²⁾ (AC-1) Enc. [V]	U _e		
CB-S	start	6	10	10	500	green	037H0110
CB-I	start pulse ³⁾	6	10	10	500	green	037H0117
CB-NO	make	6	10	10	500	green	037H0111
CB-NC	break	6	10	10	500	red	037H0112
CB-EM	early make	6	10	10	500	white	037H0113
CB-LB	late break	6	10	10	500	blue	037H0114

¹⁾ The thermal current value I_{th} gives the maximal load at 40 °C, which corresponds to installing the contactor in air (open).
²⁾ The thermal current value I_{the} gives the maximal load at 60 °C, corresponding installing the contactor inside an enclosure.
³⁾ Without self-holding function.

Auxiliary contact block CB- with gold-plated contacts (PLC-compatible)



Type	Contact function	Load		Colour code	Code no.
		I _e mA	U _e V		
CB-NO	make	1 – 30	5 – 30	white	037H0121
CB-NC	break	1 – 30	5 – 30	blue	037H0122

CB auxiliary contact blocks are force-actuated when mounted on CI 6 – CI 30 and can therefore form part of safety switching.

In the standard auxiliary contact CB - the silver tips on the moreable contact is cross stamped and PLC-compatible.
 Min. load 24 V, 10 mA.

Accessories for contactors CI 6 – CI 50



Description	Comments	Code no.
Mech. interlock for CI 6 – CI 30 CI 9 DC – CI 30 DC, CI 9 EI – CI 30 EI	Mech. interlock can be established between pairs (1-off).	037H009166
Mech. interlock for CI 32 – CI 50	Mech. interlock can be established between	037H010666
RC Element for CI 6 – CI 30	Reduces overvoltage on de-energization of coils	
	Type RC 250 (110 – 250 V, 50/60 Hz)	037H0076
	Type RC 415 (380 – 415 V, 50/60 Hz)	037H0077
Rating plate for CI 6 - 50	Rating plate, can be mounted in auxiliary contact space (10-off)	037H010166
Clip-on markers for CI 5 – CI 60 and auxiliary contact blocks	Clip-on markers can be mounted on CI 6 – CI 50 and auxiliary contact blocks type CB- (250-off)	037H010566

ON-delay clip-on timers for AC control voltage 50 / 60 Hz

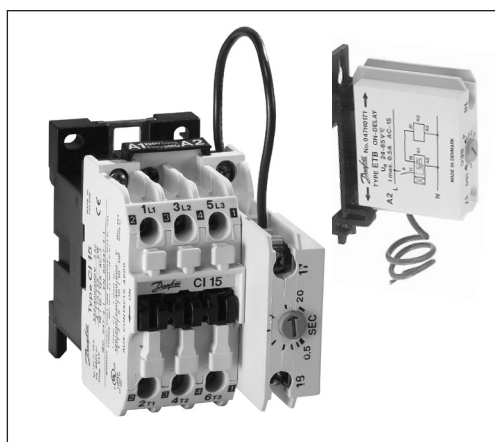

ETB electronic clip-on timers are for use with Danfoss contactors to delay contactor close and open.

The clip-on timers can be clipped direct onto contactors CI 6 – CI 50 and occupy as little space as one auxiliary contact.

Where separate mounting at the side of contactors is required, a DIN rail mounting base is available.

ETB

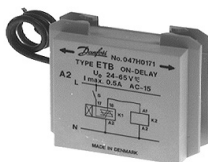

Type	Time range	Voltage range	Code no.
		[V]	
ETB	0.5 – 20 s	24 – 65	047H0170
	4 – 160 s	24 – 65	047H0171
	0.5 – 20 s	110 – 240	047H0173
	4 – 160 s	110 – 240	047H0174
	0.5 – 20 min	110 – 240	047H0175

OFF-delay clip-on timers for AC control voltage 50 / 60 Hz

Type	Time range	Voltage range	Code no.
		[V]	
ETB	0.5 – 20 s	24 – 65	047H0180
	4 – 160 s	24 – 65	047H0181
	0.5 – 20 min	24 – 65	047H0182
	0.5 – 20 s	110 – 240	047H0183
	4 – 160 s	110 – 240	047H0184
	0.5 – 20 min	110 – 240	047H0185

Accessory for ETB



Description	Comments	Code no.
DIN rail base for ETB	For separate mounting of clip-on timers ETB	047H016466

**Thermal overload relays
TI 16C, TI 25C, TI 30C for
contactors CI 6 – CI 30**



Thermal overload relays TI 16C, TI 25C and TI 30C are used with contactors CI 6 – CI 30 to give protection of squirrel-cage motors of 0.09 kW to 15 kW.

The relays have single-phase protection, i.e. accelerated release if phase drop-out occurs. This is particularly important for motors with delta-connected windings.

Other features of TI 16C / 25C / 30C:

- stop/reset button
- manual/automatic reset
- test button
- double scale for direct start or Y/D start
- galvanically isolated signal contact

Type	Range		Max. fuse ¹⁾				HRC ²⁾ II [A]	Code no.
	Motor-starter [A]	Y/D-starter [A]	gI, gL, gG		BS 88, type T			
			Type 1 [A]	Type 2 [A]	Type 1 [A]	Type 2 [A]		
TI 16C	0.13 – 0.20	–	25	–	32	–	1	047H0200
	0.19 – 0.29	–	25	–	32	2	1	047H0201
	0.27 – 0.42	–	25	2	32	2	1	047H0202
	0.4 – 0.62	–	25	2	32	4	1	047H0203
	0.6 – 0.92	–	25	4	32	6	3	047H0204
	0.85 – 1.3	–	25	4	32	6	3	047H0205
	1.2 – 1.9	–	25	6	32	10	6	047H0206
	1.8 – 2.8	3.2 – 4.8	25	6	32	10	15	047H0207
	2.7 – 4.2	4.7 – 7.3	25	16	32	20	15	047H0208
	4.0 – 6.2	6.9 – 10.7	35	20	40	25	15	047H0209
	6.0 – 9.2	10 – 16	50	20	50	25	35	047H0210
TI 25C	8.0 – 12	13 – 20.8	63	25	63	32	35	047H0211
	11 – 16	19 – 27	80	25	80	32	50	047H0212
TI 30C	15 – 20	26 – 35	80	35 ³⁾	80	40	60	047H0213
	19 – 25	33 – 43	80	63	80	63	60	047H0214
	24 – 32	41 – 55	80	63	80	63	60	047H0215

¹⁾ To IEC 947-4 coordination types 1 and 2:

Coordination type 1: Any type of damage to the motor starter is permissible. If the motor starter is in an enclosure, no external damage to the enclosure is permissible. After a short-circuit the thermal overload relay shall be partially or wholly replaced.

Coordination type 2: No damage to the motor starter is permissible, but slight contact burning and welding is permissible.

²⁾ In accordance with HRC form II, TI 16C, TI 25C and TI 30C are suitable for operation in Canada and the USA.

³⁾ 50 A in Norway.

Selection of thermal overload relay

The selection of a thermal overload relay must be based on the motor full load current and the method of starting:

- With direct start the range for motor starter is used.
- With star-delta start the range for Y/D starter is used.

Example:

Full load current: 16 A

- With direct start, the suitable motor starter range is 11 – 16 A, i.e. thermal overload relay **047H0212**.
- With star-delta start, the suitable Y/D starter range is 10 – 16 A, i.e. thermal overload relay **047H0210**.

The range 13 – 20.8 A could also be used, but thermal overload relay 047H0211 will not release as quickly if one phase drops out.

**Thermal overload relays
TI 80**



Thermal overload relays TI 80 are used with contactors CI 32 – 50 to give protection of squirrel-cage motors of 7.5 kW to 25 kW. The relays have single-phase protection, i.e. accelerated release if phase drop-out occurs. This is particularly important for motors with delta-connected windings.

Other features of TI 80:

- stop/reset button
- manual/automatic reset
- test button
- double scale for direct start or Y/D start
- signal contact with changeover

Type	Range		Max. fuse ¹⁾				Code no.
	Motor-starter [A]	Y/D-starter [A]	gI, gL, gG		BS 88, type T		
			Type 1 [A]	Type 2 [A]	Type 1 [A]	Type 2 [A]	
TI 80	16 – 23	28 – 40	125	63	125	63	047H1013
	22 – 32	38 – 56	125	63	125	63	047H1014
	30 – 45	52 – 78	125	100	125	100	047H1015
	42 – 63	75 – 109	–	100	–	125	047H1016

¹⁾ To IEC 947-4 coordination types 1 and 2:

Coordination type 1: Any type of damage to the motor starter is permissible. If the motor starter is in an enclosure, no external damage to the enclosure is permissible. After a short-circuit the thermal overload relay shall be partially or wholly replaced.

Coordination type 2: No damage to the motor starter is permissible, but slight contact burning and welding is permissible.

Selection of thermal overload relay

The selection of a thermal overload relay must be based on the motor full load current and the method of starting:

- With direct start the range for motor starter is used.
- With star-delta start the range for Y/D starter is used.

Example:

Full load current: 45 A

- With direct start, the suitable motor starter range is 30 – 45 A, i.e. thermal overload relay **047H1015**.
- With star-delta start, the suitable Y/D starter range is 38 – 56 A, i.e. thermal overload relay **047H1014**.

Accessories for thermal overload relays TI 16C - 30C

Type	Description	Comments	Code no.
	Clip-on marker	For thermal overload relays TI 16C, 25C and 30C (250-off)	037H010566
	Holder for sep. mounting	Mounting of thermal overload relays TI 16C, 25C and 30C on 35 mm DIN rail	047H016566
	Base for TI 16C	Separate mounting of thermal overload relays TI 16C	047L040566
	Base for TI 80	Separate mounting of thermal overload relays TI 80 (20-off)	047L045666
	Stop-pushbutton extension	For thermal overload relays TI 16C-80 (3 mm)	047L040666
	Current rail set	For direct mounting of thermal overload relay TI 80 on contactors	037H010866

Enclosures for the CI range up to 30 A

Enclosures for the CI range up to 30 A are made of plastic and offer a very high degree of enclosure (IP 55 to IEC 529). They are fitted with a DIN rail and there is ample space for a timer block (ETB) at the side of the contactor. There is an earth terminal and a loop terminal in the bottom of the enclosure. There are versions with four knockouts for M20/25 cable entries.

Enclosure BCI and BCI 1: Up to four auxiliary contact blocks can be fitted on each contactor. Box BCI 2: In addition to the start contact, two auxiliary contact blocks can be fitted to a three-pole contactor.

Plastic enclosures for motor starters up to 30 A (IP 55)

Type	Application	Pushbuttons	Knockouts	Code no.
BCI	Control relay / Contactor	None	4 M 20/4 M 25	047B010666
BCI 1	Motor starter	Stop / reset	4 M 20/4 M 25	047B010466
BCI 2	Motor starter	Start-Stop / reset	4 M 20/4 M 25	047B010266

Ordering of motor starter components
DOL starters (contactors CI 6 – CI 30 + thermal overload relays TI 16C – TI 30C + enclosure) 3 x 380-415 V

Motor ³⁾		Thermal overload relay			Contactor		Max. fuse ¹⁾		Enclosure				Start contact	
Output	Fullload current	Range					gI, gL, gG	gI, gL, gG	with stop-reset		with start-stop/reset		Necessary only with start-stop/reset	
[kW]	[A]	[A]	Type	Code no.	Type	Code no. ⁴⁾	Type 2 [A]	Type 1 [A]	Type	Code no.	Type	Code no.	Type	Code no.
0.09	0.35	0.27 – 0.42	TI 16C	047H0202	CI 6	037H0015	2	25	BCI 1	047B010466	BCI 2	047B010266	CB-S	037H0110
0.12	0.46	0.4 – 0.62	TI 16C	047H0203	CI 6	037H0015	2	25	BCI 1	047B010466	BCI 2	047B010266	CB-S	037H0110
0.18	0.62	0.4 – 0.62	TI 16C	047H0203	CI 6	037H0015	2	25	BCI 1	047B010466	BCI 2	047B010266	CB-S	037H0110
0.25	0.82	0.6 – 0.92	TI 16C	047H0204	CI 6	037H0015	4	25	BCI 1	047B010466	BCI 2	047B010266	CB-S	037H0110
0.37	1.3	0.85 – 1.3	TI 16C	047H0205	CI 6	037H0015	4	25	BCI 1	047B010466	BCI 2	047B010266	CB-S	037H0110
0.55	1.7	1.2 – 1.9	TI 16C	047H0206	CI 6	037H0015	6	25	BCI 1	047B010466	BCI 2	047B010266	CB-S	037H0110
0.75	2.1	1.8 – 2.8	TI 16C	047H0207	CI 6	037H0015	6	25	BCI 1	047B010466	BCI 2	047B010266	CB-S	037H0110
1.1	2.9	2.7 – 4.2	TI 16C	047H0208	CI 6	037H0015	16	25	BCI 1	047B010466	BCI 2	047B010266	CB-S	037H0110
1.5	3.7	2.7 – 4.2	TI 16C	047H0208	CI 6	037H0015	16	25	BCI 1	047B010466	BCI 2	047B010266	CB-S	037H0110
2.2	5.3	4.0 – 6.2	TI 16C	047H0209	CI 6	037H0015	20	35	BCI 1	047B010466	BCI 2	047B010266	CB-S	037H0110
3	7.0	6.0 – 9.2	TI 16C	047H0210	CI 9	037H0021	20	50	BCI 1	047B010466	BCI 2	047B010266	CB-S	037H0110
4	9.0	6.0 – 9.2	TI 16C	047H0210	CI 9	037H0021	20	50	BCI 1	047B010466	BCI 2	047B010266	CB-S	037H0110
5.5	12	8.0 – 12	TI 16C	047H0211	CI 12	037H0031	25	63	BCI 1	047B010466	BCI 2	047B010266	CB-S	037H0110
7.5	16	11 – 16	TI 16C	047H0212	CI 16	037H0041	25	80	BCI 1	047B010466	BCI 2	047B010266	CB-S	037H0110
10	20	15 – 20	TI 25C	047H0213	CI 20	037H0045	35 ²⁾	80	BCI 1	047B010466	BCI 2	047B010266	CB-S	037H0110
11	22	19 – 25	TI 25C	047H0214	CI 25	037H0051	63 ²⁾	80	BCI 1	047B010466	BCI 2	047B010266	CB-S	037H0110
15	32	24 – 32	TI 30C	047H0215	CI 30	037H0055	63 ²⁾	80	BCI 1	047B010466	BCI 2	047B010266	CB-S	037H0110

¹⁾ To IEC 60947-4 coordination types 1 and 2:

Coordination type 1: Any type of damage to the motor starter is permissible. If the motor starter is in an enclosure, no external damage to the enclosure is permissible. After a short-circuit the thermal overload relay shall be partially or wholly replaced.

Coordination type 2: No damage to the motor starter is permissible, but slight contact burning and welding is permissible.

²⁾ 50 A in Norway

³⁾ For each application, check full load current and start current of motor concerned.

⁴⁾ State the required coil voltage and frequency by suffix no.

Thermal overload relays

Type	Range	Code no.
	Motor starter [A]	
TI 16C	0.13 – 0.20	047H0200
	0.19 – 0.29	047H0201
	0.27 – 0.42	047H0202
	0.4 – 0.62	047H0203
	0.6 – 0.92	047H0204
	0.85 – 1.3	047H0205
	1.2 – 1.9	047H0206
	1.8 – 2.8	047H0207
	2.7 – 4.2	047H0208
	4.0 – 6.2	047H0209
	6.0 – 9.2	047H0210
TI 25C	8.0 – 12	047H0211
	11 – 16	047H0212
TI 30C	15 – 20	047H0213
	19 – 25	047H0214
	24 – 32	047H0215

Construction standards

Contactors, thermal overload relays and accessories are designed and tested in accordance with IEC 60947-4-1/EN 60947-4-1.

Environment

Temperate climate

Tested and passed in accordance with DIN 50 016 and 40 046 part 38 and IEC 68

Max. installation height: 2000 NN, in accordance with IEC 60947-4-1

Pulse voltage

Type	U _{imp} [kV]
CI 6 – CI 15	8
CI 16 – CI 30	8
CI 32 – CI 50	8
CI 9 DC	8
CI 9 EI – CI 30 EI	8

Ambient temperature

Type	Ambient temperature	
	Operation [°C]	Storage/Transport [°C]
CI 6 – CI 50	-30 – 70	-30 – 70
CI 9 DC – CI 30 DC	-40 – 80	-40 – 80
CI 9 EI – CI 30 EI	-30 – 60	-40 – 80

Vibration and shock
Tested and passed in
accordance with IEC 68-2-6
and IEC 68-2-7

Type	Vibration ¹⁾	Shock ²⁾
CI 6 – CI 15	4 g, 10 – 200 Hz	9 g in 11 ms
CI 16 – CI 30	4 g, 10 – 200 Hz	9 g in 11 ms
CI 32 – CI 50	1 g, 5 – 1000 Hz	6 g in 11 ms
CI 9 DC – CI 30 DC	4 g, 5 – 200 Hz	10 g in 10 ms
CI 9 EI – CI 30 EI	4 g, 5 – 200 Hz	10 g in 10 ms

¹⁾ Operating conditions: All directions with de-energized coil.

²⁾ Operating conditions: Parallel with armature and with de-energized coil

Environment

Type	Temperature compensated [°C]	Ambient temperature [°C]	Vibration	Shock perpendicular to contact system	Max. operations per hour
TI 16C	-5 – 40	-50 – 60	2 g at 200 Hz	9 g for 7.5 ms	30
TI 25C	-5 – 40	-50 – 60	2 g at 200 Hz	9 g for 7.5 ms	30
TI 30C	-5 – 40	-50 – 60	2 g at 200 Hz	9 g for 7.5 ms	30
TI 80	-5 – 40	-50 – 60	2 g at 200 Hz	9 g for 7.5 ms	30

Electromagnetic compatibility

Type	Emission	Immunity
CI 9 DC – CI 30 DC	EN 50081-1	EN 50082-2
CI 9 EI – CI 30 EI	EN 50081-1	EN 50082-2

Mounting direction

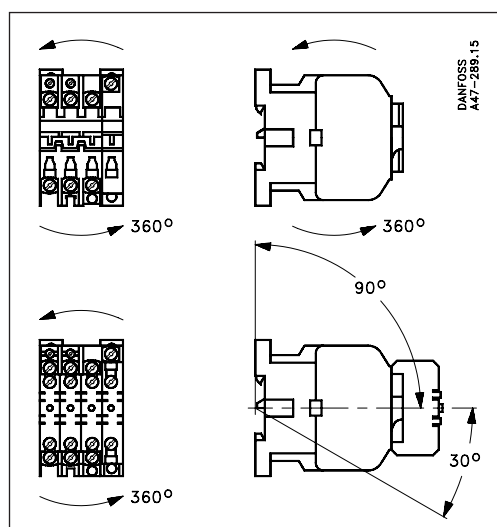

Rated life

Type	Mechanical life Operations	Electrical life AC-3 load Operations	Switching per hour AC-3 load Operations
CI 6 – CI 30	10 x 10 ⁶	1 x 10 ⁶	1200
CI 32	5 x 10 ⁶	1 x 10 ⁶	300
CI 37 – CI 50	5 x 10 ⁶	0.5 x 10 ⁶	300

Approvals & Certificates

Type	Approval authority			
	CE marked in accordance with LVD 2014/35/EU	cULus	EAC	LLC CDCTYSK
CI 6	●	●	●	●
CI 9	●	●	●	●
CI 12	●	●	●	●
CI 15	●	●	●	●
CI 16	●	●	●	●
CI 20	●	●	●	●
CI 25	●	●	●	●
CI 30	●	●	●	●
CI 32	●	●	●	●
CI 37	●	●	●	●
CI 45	●	●	●	●
CI 50	●	●	●	●
TI 16C / TI 25C / TI 30C	●	●	●	●
TI 80	●	●	●	●
CB-	●	●	●	□
ETB	●	□	✓	□
CI 9DC – CI 30 DC	●	●	●	□
CI 9EI – CI 30 EI	●	●	●	□

● Approved
 □ No approval applied

Electrical life curves

Contactors CI 6/9/12/15, CI 16/20/25/30, CI 37/45/50, load categories AC-3

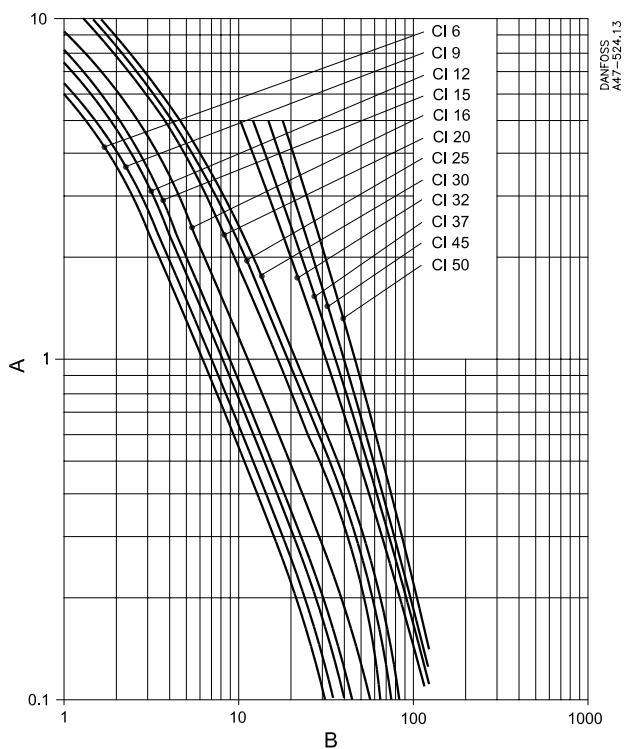

A: Electrical life in millions of make/break operations
B: Breaking current (A)

Contactors CI 6/9/12/15, CI 16/20/25/30, CI 37/45/50, load categories AC-1

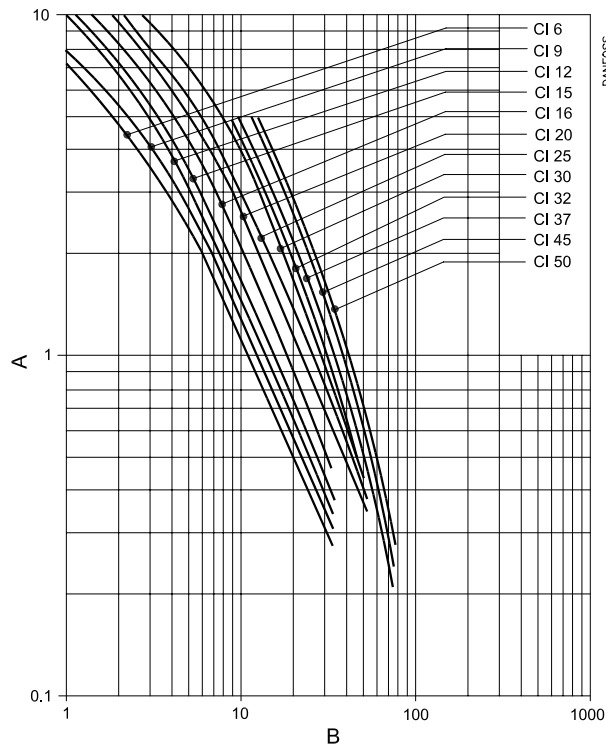

A: Electrical life in millions of make/break operations
B: Breaking current (A)

Contactors CI 6/9/12/15, CI 16/20/25/30, CI 37/45/50, load categories AC-4

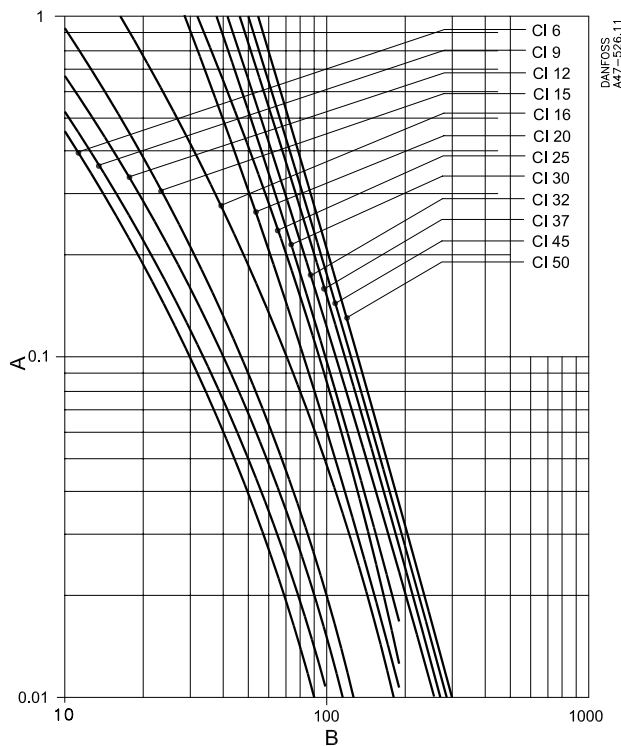

A: Electrical life in millions of make/break operations
B: Breaking current (A)

Tripping graphs

TI16C, TI 25C, TI 30C

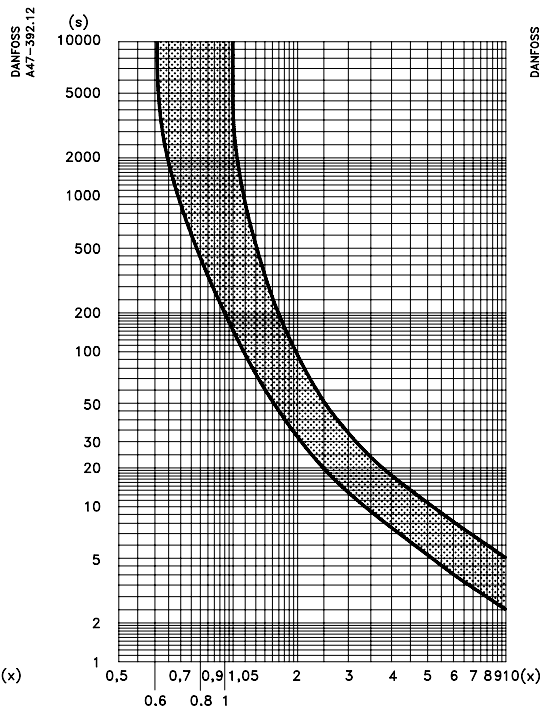
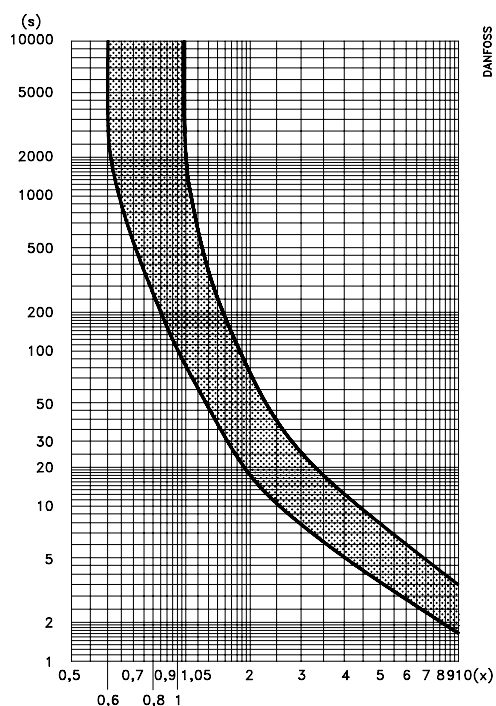

Explanation of graphs

Mean value curves

Upper curve: 3-phase tripping and asymmetric load tripping at min. setting.

Lower curve: Asymmetric load tripping at max. setting.

When tripping from the operationally warm condition, the tripping times are approx. 30% of the values shown. These values apply at an ambient temperature = 20 °C.

3-phase tripping: $x = \frac{\text{measured current}}{\text{rated motor current}}$

Asymmetric load tripping: $x = \frac{\text{measured current}}{\text{max. scale value on overload relay}}$

3-phase overload

- 1) Measure overload current
- 2) Find the overload factor (x) by dividing the measured value by the set value of the thermal overload relay (motor full load current).
- 3) Find (x) on the horizontal axis and follow a line vertically up until it intersects the upper curve.
- 4) From the intersection point, follow a horizontal line to the left and read off on the vertical axis the time that will elapse before the thermal overload relay cuts out the motor.

Asymmetric load tripping

- 1) Measure the current the motor draws from one of the intact phases.
- 2) Find the overload factor (x) by dividing the measured value by the maximum scale value of the thermal overload relay.
- 3) Find (x) on the horizontal axis and follow a line vertically up until it intersects the lower curve.
- 4) From the intersection point, follow a horizontal line to the left and read off on the vertical axis the time that will elapse before the thermal overload relay switch off the motor.

Terminal marking

Terminal marking in Danfoss contactors conforms to **EN 50005**. The idea of this marking is as follows:

Terminal markings on *main contacts* must have a single-digit number.

1. From the marking it is possible to read which terminals are associated and which functions the contacts have.
2. Control relays and contactors of different makes but with the same number of contacts must have identical terminal markings.

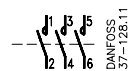

Contact set with three main contacts.

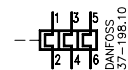

Thermal overload relay with three bimetal elements.

Relay marking

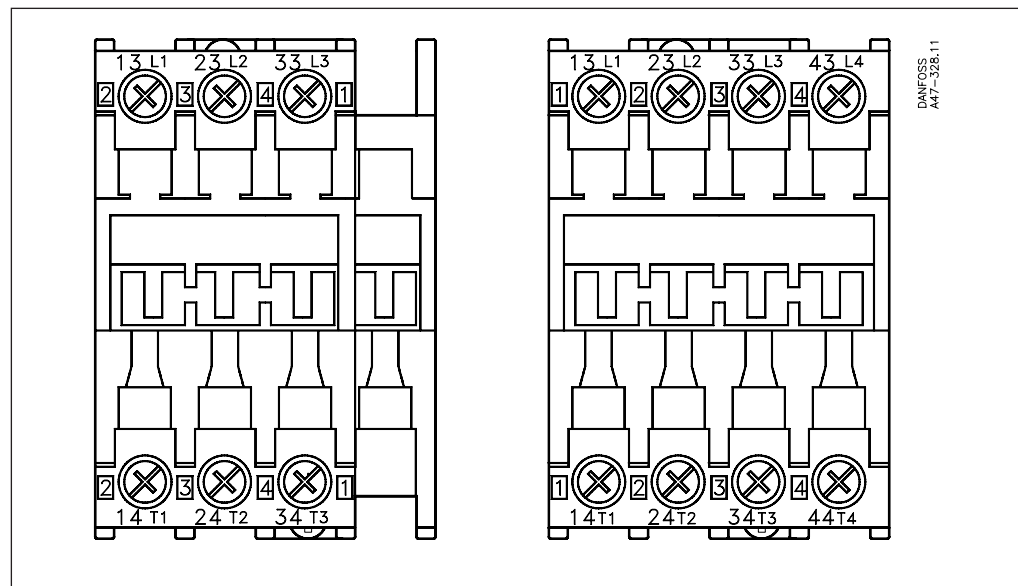



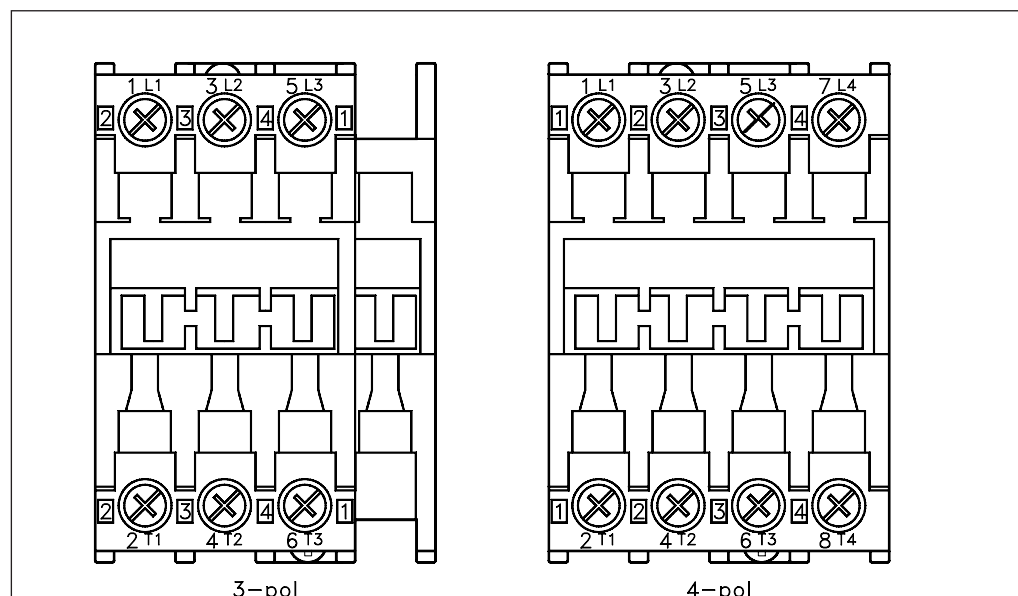

Contactor marking

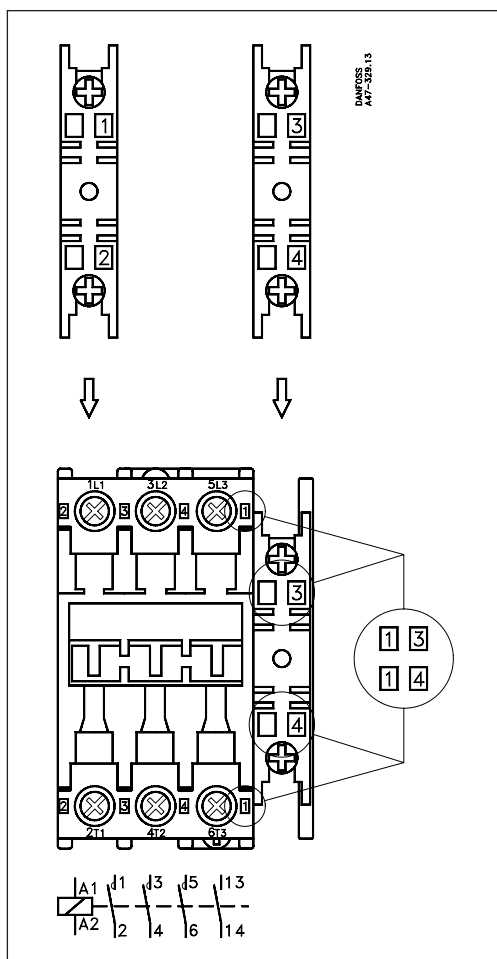

Terminal marking



Auxiliary contacts must be marked with a two-digit number.
 The first digit = contact position (position digit)
 The second digit = contact function (function digit)
 Function digits have been given the following standardized designations:

-  1 Break contacts must have function digits 1 and 2.
-  3 Make contacts should have function digits 3 and 4.
-  5 Special break contacts (early or late break) must have function digits 5 and 6.
-  7 Special make contacts (early or late make) must have function digits 7 and 8.

The placing of auxiliary contacts on contactors is clearly indicated by the position digits stamped on both parts.

Contact symbols and terminal markings

Control relays and auxiliary contacts

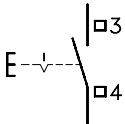
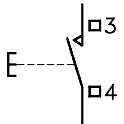
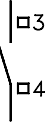
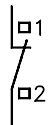
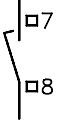
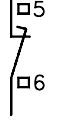
 <p>Start contact (1 NO) CB-S</p>	 <p>Impulse contact (1 NO) CB-I</p>
 <p>Auxiliary contact (1 NO) CB-NO</p>	 <p>Auxiliary contact (1 NO) CB-NC</p>
 <p>Auxiliary contact (1 EM) CB-EM</p>	 <p>Auxiliary contact (1 LB) CB-LB</p>

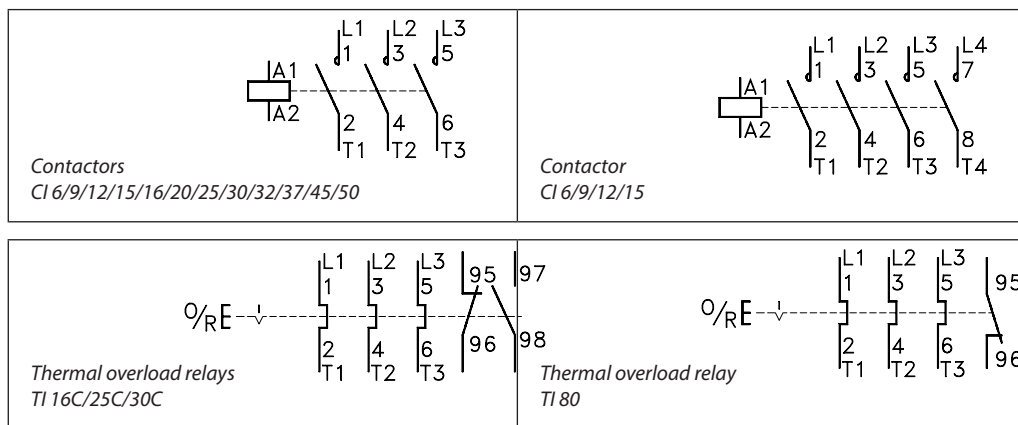

Loads
Connections, main contacts and contactor coils

Type	Connection method	Single core [mm ²]	Multi core		Recommended Tightening torque [Nm]
			without terminal sleeve [mm ²]	with terminal sleeve [mm ²]	
CI 6, CI 9, CI 12, CI 15	Screw and clamp washer	0.75 – 2.5	0.75 – 2.5	0.5 – 2.5	0.8 – 2
CI 16, CI 20, CI 25, CI 30	Screw and clamp washer	1.5 – 10	2.5 - 6	1.5 – 4	0.8 – 2.5
CI 32, CI 37, CI 45, CI 50	Box terminal	1.5 – 35	1.5 – 25	–	0.8 – 5
CI 9 DC, CI 15 DC	Screw and clamp washer	0.75 – 2.5	0.75 – 2.5	0.5 – 2.5	0.8 – 2
CI 25 DC, CI 30 DC	Screw and clamp washer	1.5 – 10	2.5 – 6	1.5 – 4	0.8 – 2.5
CI 9 EI, CI 15 EI	Screw and clamp washer	1.5 – 10	0.75 – 2.5	0.5 – 2.5	0.8 – 2
CI 25 EI, CI 30 EI	Screw and clamp washer	1.5 – 10	2.5 – 6	1.5 – 4	0.8 – 2.5
TI 16C, TI 25C, TI 30C	Screw and clamp washer	0.75 – 4	0.75 – 4	1 – 4	0.8 – 2
TI 80	Box terminal	1.5 – 35	1.5 – 25	–	0.8 – 3.5
Coils	Screw and clamp washer	0.75 – 1.5	0.75 – 1.5	0.75 – 1.5	0.5 – 1.4

Direct start, load categories AC-2, AC-3, AC-4

Type		Rated loads at 50-60 Hz					
		220 – 230 V	240 V	380 – 400 V	415 V	500 V	690 V
CI 6	A	6	6	6	6	4	2.7
	kW	1.5	1.5	2.2	2.2	2.2	2.2
CI 9	A	9	9	9	9	7	5
	kW	2.2	2.2	4	4	4	4
CI 9 EI / DC	A	9	9	9	9	7	5
	kW	2.2	2.2	4	4	4	4
CI 12	A	12	12	12	12	9	7
	kW	3	3	5.5	5.5	5.5	5.5
CI 15	A	16	16	16	16	12	–
	kW	4	4	7.5	7.5	7.5	–
CI 15 EI / DC	A	16	16	16	16	12	–
	kW	4	4	7.5	7.5	7.5	–
CI 16	A	16	16	16	16	12	9
	kW	4	4	7.5	7.5	7.5	7.5
CI 20	A	20	20	20	20	15	11
	kW	5.5	5.5	10	10	10	10
CI 25	A	25	25	25	25	18	14
	kW	5.5	5.5	11	11	11	11
CI 25 EI / DC	A	25	25	25	25	18	14
	kW	5.5	5.5	11	11	11	11
CI 30	A	32	32	32	30	23	17
	kW	8.5	8.5	15	15	15	15
CI 30 EI / DC	A	32	32	32	30	23	17
	kW	8.5	8.5	15	15	15	15
CI 32	A	32	32	32	30	25	–
	kW	8.5	9	15	15	15	–
CI 37	A	37	37	37	37	29	–
	kW	10	11	18.5	18.5	18.5	–
CI 45	A	45	45	45	45	35	–
	kW	11	12.5	22	22	22	–
CI 50	A	52	52	52	52	40	–
	kW	15	16	25	25	25	–

Table (continued)

Star-delta start, load categories AC-3

Type	Rated loads at 50-60 Hz						
		220 – 230 V	240 V	380 – 400 V	415 V	500 V	690 V
kgh	A	10	10	10	10	7	5
	kW	2.2	2.2	4	4	4	4
CI 9	A	16	16	16	16	12	9
	kW	4	4	7.5	7.5	7.5	7.5
CI 9 EI/ DC	A	16	16	16	16	12	9
	kW	4	4	7.5	7.5	7.5	7.5
CI 12	A	21	21	21	21	16	12
	kW	5.5	5.5	10	10	10	10
CI 15	A	27	27	27	27	21	–
	kW	7.5	7.5	11	11	11	–
CI 15 EI / DC	A	27	27	27	27	21	–
	kW	7.5	7.5	11	11	11	–
CI 16	A	27	27	27	27	21	16
	kW	7.5	7.5	11	11	11	11
CI 20	A	35	35	35	35	26	19
	kW	10	10	15	15	15	15
CI 25	A	43	43	43	43	31	24
	kW	11	11	22	22	22	22
CI 25 EI/ DC	A	43	43	43	43	31	24
	kW	11	11	22	22	22	22
CI 30	A	52	52	52	52	40	30
	kW	15	15	25	25	25	25
CI 30 EI/ DC	A	52	52	52	52	40	30
	kW	15	15	25	25	25	25
CI 32	A	56	56	56	56	43	–
	kW	15	15	30	30	30	–
CI 37	A	64	64	64	64	50	–
	kW	18.5	18.5	33	33	33	–
CI 45	A	78	78	78	78	55	–
	kW	22	22	37	37	37	–
CI 50	A	85	85	85	85	65	–
	kW	25	25	45	45	45	–

Three phase ohmic load, load category AC-1

Type	Operating temperature max. 40 °C (Open condition)						
		220 – 230 V	240 V	380 – 400 V	415 V	500 V	690 V
CI 6	A	20	20	20	20	20	20
	kW	8	8	14	14	17	22
CI 9 / CI 12 / CI 15	A	25	25	25	25	25	25
	kW	9	10	16	17	20	28
CI 9 EI / DC CI 15 EI / DC	A	25	25	25	25	25	25
	kW	9	10	16	17	20	28
CI 16 / CI 20 / CI 25 / CI 30	A	40	40	40	40	40	40
	kW	15	16	26	27	33	45
CI 25 EI / DC CI 30 EI / DC	A	40	40	40	40	40	40
	kW	15	16	26	27	33	45
CI 32	A	63	63	63	63	63	–
	kW	23	24	41	43	51	–
CI 37 / CI 45 / CI 50	A	80	80	80	80	80	–
	kW	30	31	52	54	65	–

Table (continued)

Three phase ohmic load, load category AC-1

Type	Operating temperature max. 60 °C (Enclosed condition)						
		220 – 230 V	240 V	380 – 400 V	415 V	500 V	690 V
CI 6 / CI 9	A	16	16	16	16	16	16
	kW	6,4	6,7	11	12	14	18
CI 9 EI / CI 9 DC	A	16	16	16	16	16	16
	kW	6,4	6,7	11	12	14	18
CI 12 / CI 15	A	20	20	20	20	20	20
	kW	7	8	13	14	16	22
CI 15 EI / CI 15 DC	A	20	20	20	20	20	20
	kW	7	8	13	14	16	22
CI 16 / CI 20 / CI 25	A	25	25	25	25	25	25
	kW	9	10	16	17	20	28
CI 25 EI / CI 25 DC	A	25	25	25	25	25	25
	kW	9	10	16	17	20	28
CI 30	A	30	30	30	30	30	30
	kW	11	12	19	20	24	35
CI 30 EI / CI 30 DC	A	30	30	30	30	30	30
	kW	11	12	19	20	24	35
CI 32 / CI 37	A	63	63	63	63	63	–
	kW	23	24	41	43	51	–
CI 45 / CI 50	A	80	80	80	80	80	–
	kW	30	31	52	54	65	–

Three phase ohmic load, load category AC-1

Type	Operating temperature max. 40 °C (Open condition) Heat resistant cable only (min. 75 °C)						
		220 – 230 V	240 V	380 – 400 V	415 V	500 V	690 V
CI 15	A	30	30	30	30	30	30
	kW	11	12	19	20	24	34
CI 15 EI / CI 15 DC	A	30	30	30	30	30	30
	kW	11	12	19	20	24	34
CI 16 / CI 20 / CI 25	A	45	45	45	45	45	45
	kW	17	18	29	30	37	51
CI 25 EI / CI 25 DC	A	45	45	45	45	45	45
	kW	17	18	29	30	37	51
CI 30	A	50	50	50	50	50	50
	kW	18	19	32	34	41	56
CI 30 EI / CI 30 DC	A	50	50	50	50	50	50
	kW	18	19	32	34	41	56
CI 45 / CI 50	A	90	90	90	90	90	–
	kW	34	35	59	61	74	–

Switching three phase power transformers (AC-6a)

Type	Transformer load, (factor n = 30, inrush current = n x rated transformer current)						
		220 – 230 V	240 V	380 – 400 V	415 V	500 V	690 V
CI 6	A	3	3	3	30	3	3
	kVA	1	1	2	2	2	3
CI 9	A	4	4	4	4	4	4
	kVA	1	1	2	2	3	4
CI 9 EI / CI 9 DC	A	4	4	4	4	4	4
	kVA	1	1	2	2	3	4
CI 12	A	5	5	5	5	5	5
	kVA	2	2	3	3	4	5
CI 15	A	6	6	6	6	6	6
	kVA	2	2	4	4	5	7
CI 15 EI / CI 15 DC	A	6	6	6	6	6	6
	kVA	2	2	4	4	5	7
CI 16	A	7	7	7	7	7	7
	kVA	2	2	4	5	6	8
CI 20	A	9	9	9	9	9	9
	kVA	3	3	6	6	7	10
CI 25	A	11	11	11	11	11	11
	kVA	4	4	7	7	9	13
CI 25 EI / CI 25 DC	A	11	11	11	11	11	11
	kVA	4	4	7	7	9	13
CI 30	A	13	13	13	13	13	13
	kVA	5	5	9	9	11	15
CI 30 EI / CI 30 DC	A	13	13	13	13	13	13
	kVA	5	5	9	9	11	15
CI 32	A	14	14	14	14	14	–
	kVA	5	5	9	10	12	–
CI 37	A	17	17	17	17	17	–
	kVA	6	7	11	12	14	–
CI 45	A	20	20	20	20	20	–
	kVA	7	8	13	14	17	–
CI 50	A	23	23	23	23	23	–
	kVA	9	9	15	16	19	–

Load category

Switching lighting

Type	Incandescent lamps (AC-5b) Max. operating current	Fluorescent lamps, individually compensated (AC-5a)					
		Max. operat. current [A] at operat. temperature ¹⁾			Max. capacity [μ F] at $I_{cc} =$		
		A	40 °C	60 °C	10 kA	20 kA	50 kA
CI 6 / CI 9 / CI 12 / CI 15	12	20	12	1000	500	200	
CI 9 EI / CI 15 EI	12	20	12	1000	500	200	
CI 9 DC / CI 15 DC	12	20	12	1000	500	200	
CI 16 / CI 20 / CI 25 / CI 30	20	33	22	2700	1350	540	
CI 25 EI / CI 30 EI	20	33	22	2700	1350	540	
CI 25 DC / CI 30 DC	20	33	22	2700	1350	540	
CI 32	35	40	27	3200	1600	540	
CI 37 / CI 45 / CI 50	45	47	33	3200	1600	640	

¹⁾ 40 °C is defined as non-enclosed installation
60 °C is defined as enclosed installation

Switching capacitor loads, individual capacitors Inductance in leads between capacitors connected in parallel min. 6 μ H.

Type	Max. reactive power [kVar] ¹⁾							
	220 – 240 V		380 – 415 V		500 V		690 V	
	40 °C	60 °C	40 °C	60 °C	40 °C	60 °C	40 °C	60 °C
CI 6 / CI 9 / CI 12 / CI 15	6	4	10	6	12	8	16	10
CI 9 EI / CI 15 EI	6	4	10	6	12	8	16	10
CI 9 DC / CI 15 DC	6	4	10	6	12	8	16	10
CI 16 / CI 20 / CI 25 / CI 30	10	6	16	10	22	15	30	20
CI 25 EI / CI 30 EI	10	6	16	10	22	15	30	20
CI 25 DC / CI 30 DC	10	6	16	10	22	15	30	20
CI 32	11	7	18	12	22	15	–	–
CI 37 / CI 45 / CI 50	14	10	24	18	31	21	–	–

¹⁾ 40 °C is defined as non-enclosed installation
60 °C is defined as enclosed installation

Switching capacitor loads, regulating capacitors Inductance in leads between parallel-connected capacitors must be min. 6 μ H

Type	Max. reactive power [kVar] ¹⁾							
	220 – 240 V		380 – 415 V		500 V		690 V	
	40 °C	60 °C	40 °C	60 °C	40 °C	60 °C	40 °C	60 °C
CI 6 / CI 9 / CI 12 / CI 15	5	4	6	6	6	6	6	6
CI 9 EI / CI 15 EI	5	4	6	6	6	6	6	6
CI 9 DC / CI 15 DC	5	4	6	6	6	6	6	6
CI 16 / CI 20 / CI 25 / CI 30	10	6	12	11	12	11	12	11
CI 25 EI / CI 30 EI	10	6	12	11	12	11	12	11
CI 25 DC / CI 30 DC	10	6	12	11	12	11	12	11
CI 32	11	7	12	12	12	12	–	–
CI 37 / CI 45 / CI 50	14	10	18	16	18	16	–	–

¹⁾ 40 °C is defined as non-enclosed installation
60 °C is defined as enclosed installation

Switching direct current load Load categories DC-3 and DC-5, contacts connected in series

Type	Max. operating current [A]									
	DC-3, 3-pole in series					DC-5, 3-pole in series				
	24 V	48 V	110 V	220 V	440 V	24 V	48 V	110 V	220 V	440 V
CI 6 / CI 9	9	9	4.5	1.8	0.6	9	5	2	0.8	0.3
CI 9 EI / CI 15 EI	9	9	4.5	1.8	0.6	9	5	2	0.8	0.3
CI 9 DC / CI 15 DC	9	9	4.5	1.8	0.6	9	5	2	0.8	0.3
CI 12 / CI 15	16	16	6.5	2.5	0.6	16	8	3	1.2	0.4
CI 15 EI	16	16	6.5	2.5	0.6	16	8	3	1.2	0.4
CI 15 DC	16	16	6.5	2.5	0.6	16	8	3	1.2	0.4
CI 16 / CI 20 / CI 25 / CI 30	30	30	22	6	0.6	30	16	6	2.5	0.85
CI 25 EI / 30 EI	30	30	22	6	0.6	30	16	6	2.5	0.85
CI 25 DC / 30 DC	30	30	22	6	0.6	30	16	6	2.5	0.85

Switching direct current load Load category DC-1, contacts connected in series

Type	Max. operating current [A]														
	24 V			48 V			110 V			220 V			440 V		
	1-pole	2-pole	3-pole	1-pole	2-pole	3-pole	1-pole	2-pole	3-pole	1-pole	2-pole	3-pole	1-pole	2-pole	3-pole
CI 6 / CI 9	9	9	9	9	9	9	3.5	8	9	0.55	3.5	6	0.2	0.55	2
CI 9 EI	9	9	9	9	9	9	3.5	8	9	0.55	3.5	6	0.2	0.55	2
CI 9 DC	9	9	9	9	9	9	3.5	8	9	0.55	3.5	6	0.2	0.55	2
CI 12 / CI 15	16	16	16	16	16	16	5.2	15	16	0.8	5.2	10	0.2	0.8	3
CI 15 EI	16	16	16	16	16	16	5.2	15	16	0.8	5.2	10	0.2	0.8	3
CI 15 DC	16	16	16	16	16	16	5.2	15	16	0.8	5.2	10	0.2	0.8	3
CI 16 / CI 20 / CI 25 / CI 30	30	30	30	25	30	30	8	22	30	1.5	8	16	0.3	1.2	4.5
CI 25 EI / CI 30 EI	30	30	30	25	30	30	8	22	30	1.5	8	16	0.3	1.2	4.5
CI 25 DC / CI 30 DC	30	30	30	25	30	30	8	22	30	1.5	8	16	0.3	1.2	4.5

Power loss

Contact resistance and power losses

Type	Typical impedance pr pole [mΩ]	Power losses all 3 poles		Coil consumption AC [W]	Total power losses	
		AC-3 [W]	AC-1 [W]		AC-3 [W]	AC-1v [W]
CI 6	2.1	0.2	2.5	2.7	2.9	5.2
CI 9	1.8	0.4	3.4	2.7	3.1	6.1
CI 12	1.6	0.7	3.0	2.7	3.4	5.7
CI 15	1.6	1.1	3.0	2.7	3.8	5.7
CI 16	1.1	0.8	5.3	2.7	3.5	8
CI 20	1.1	1.3	5.3	2.7	4	8
CI 25	1.1	2.1	5.3	2.7	4.8	8
CI 30	0.8	2.2	3.8	2.7	4.9	6.5
CI 32	0.9	2.8	11	3	5.8	14
CI 37	0.8	3.3	15	3	6.3	18
CI 45	0.8	4.9	15	3	7.9	18
CI 50	0.8	6.0	15	3	9	18
CI 9DC	1.8	0.4	3.4	1.5	1.9	5.3
CI 15DC	1.6	1.1	3	1.5	2.6	4.5
CI 25DC	1.1	2.1	5.3	1.5	3.6	6.8
CI 30DC	0.8	2.2	3.8	1.5	3.7	5.3
CI 9EI	1.8	0.4	3.4	1.5	1.9	5.3
CI 15EI	1.6	1.1	3	1.5	2.6	4.5
CI 25EI	1.1	2.1	5.3	1.5	3.6	6.8
CI 30EI	0.8	2.2	3.8	1.5	3.7	5.3

Type	Average power	
	Min. setting [W]	Max. setting [W]
TI 16C	Typically 2.15	Typically 4.87
TI 25C	Typically 2.15	Typically 4.87
TI 30C	Typically 2.15	Typically 4.87
TI 80	Typically 5.17	Typically 10.8

Short time withstand current I_{cw}

Type	Current transfer time in sec.							Min. cooling in min.
	0.2	1	2	4	10	100	1000	
	Short time withstand current in Amps (I_{cw})							
CI 6, CI 9, CI 12, CI 15	550	250	200	160	120	60	40	3
CI 9 EI, CI 15 EI	550	250	200	160	120	60	40	3
CI 9 DC, CI 15 DC	550	250	200	160	120	60	40	3
CI 16, CI 20, CI 25, CI 30	1000	700	500	360	240	110	80	6
CI 25 EI, CI 30 EI	1000	700	500	360	240	110	80	6
CI 25 DC, CI 30 DC	1000	700	500	360	240	110	80	6
CI 32	–	1000	800	580	380	200	100	12
CI 37, CI 45, CI 50	–	1300	1000	900	580	240	120	12

Data sheet | Contactors, type CI 6 – CI 50

Connections, auxiliary contacts

Type	Connection method	Single core [mm ²]	Multi core		Tightening torque [Nm]
			without terminal sleeve [mm ²]	with terminal sleeve [mm ²]	
CB- for CI 6 – CI 50	Screw and clamp washer	0.75 – 2.5	0.75 – 2.5	0.75 – 1.5	1 – 1.5
TI 16C, TI 25C, TI 30C, TI 80	Screw and clamp washer	0.75 – 1.5	0.75 – 1.5	0.5 – 1.5	0.3 – 1

Coils, consumption and operating times

Type	Inrush power			Holding power			Pull-in voltage		Drop-out voltage		Make time		Break time	
	AC		DC	AC		DC	AC	DC	AC	DC	AC	DC	AC	DC
	VA	W	W	VA	W	W	V	V	V	V	ms	ms	ms	ms
CI 6 – CI 30	75	65		9	2.7		$(0.85 - 1.1) \times U_s$		$(0.35 - 0.65) \times U_s$		10 – 17		8 – 10	
CI 32 – CI 50	140	80		11	3		$(0.85 - 1.1) \times U_s$		$(0.35 - 0.65) \times U_s$		9 – 16		7 – 13	
CI 9DC – CI 30DC			65			1.5		0.7-1.33		0.4-0.55		12 – 18		80 – 120
CI 9 EI – CI 30 EI	50	65	3.5 mA	2.8	1.5	3.5 mA	$(0.75 - 1.1) \times U_s$	$(0.6 - 1.2) \times U_s$	$(0.4 - 0.55) \times U_s$	$(0.3 - 0.5) \times U_s$		12 – 18		10 – 16

RC Element (charge suppressor)

Type	Comments	Overvoltage factor $n = \frac{U_{max}}{U_N}$
RC	Suitable for contactors CI 6 – CI 30	1 – 1.5
RCB	Suitable for contactors CI 32 – CI 50	1 – 2.0

Max. load control circuit (contact system)

Type	Load		Max fuse	
	AC-15	DC-13	gI, gL, gG	BS 88 type T
TI 16C	500 V 2 A	250 V 2 A	4 A	6 A
TI 25C	200 VA	20 W		
TI 30C				
TI 80	500 V 2 A 200 VA	250 V 2 A 20 W	4 A	6 A

UL/CSA specifications

UL/CSA approved loads

Type	Motor load (AC-3) [hp]						Other loads (AC-1) [A]			
	1-phase		3-phase				UL		CSA	
	115 V	230 V	200 V	240 V	460 V	575 V	40 °C ¹⁾	60 °C ¹⁾	40 °C ¹⁾	60 °C ¹⁾
CI 6	0.5	1	1.5	2	3	5	16	16	20	20
CI 9	0.5	1.5	2	3	5	7.5	16	16	20	20
CI 12	0.75	2	3	4	7.5	10	20	20	20	20
CI 15	1	3	3	5	10	10	25	25	25	25
CI 16	1	3	5	5	10	15	40	40	40	40
CI 20	1.5	3	5	5	10	15	40	40	40	40
CI 25	2	4	7.5	7.5	15	20	40	40	40	40
CI 30	2	5	10	10	20	20	40	40	40	40
CI 32	3	5	10	10	20	25	70	63	70	63
CI 37	3	7.5	15	15	25	30	80	70	80	70
CI 45	4	7.5	15	15	30	30	80	70	80	70
CI 50	5	10	15	15	30	40	80	70	80	70

¹⁾ 40 °C is defined as non-enclosed installation

60 °C is defined as enclosed installation

Auxiliary contacts, UL/CSA-approved loads

Type	Comments	Load capacity	
		AC	
		Category	[VA]
CB-	For contactors CI 6..CI 50	A600	720

Clip-on timer type ETB

Specification	
Contact functions	1-pole contact without galvanic isolation (Triac)
Time ranges	0.5 – 20 s, 4 – 160 s, 0.5 – 20 min.
Voltage range AC	24 – 65 V / 50 – 60 Hz and 110 – 240 V / 50 – 60 Hz
Voltage range DC	24 – 65 V and 110 – 240 V
Voltage tolerance	-15 – 10%
Ambient temperature (operation)	-10 – 55%
Ambient temperature (storage and transport)	-40 – 70 °C
Repeat accuracy	± 2% at constant voltage and temperature
Time for reset (dwell time)	Min. 400 ms
Lead cross-section	0.75 – 2.5 mm ²

Load		
Max. load AC	$I_{th} = 0,5 \text{ A AC-15}$	
Min. load AC	15 mA	
Max. load DC	$I_{th} = 0,5 \text{ A}, I_{max} = 7 \text{ A for 20 ms}$	
Min. load DC	5 mA	
Consumption	Voltage [V]	Power [mW]
Delayed cut-in AC	65	300
Delayed cut-in AC	240	370
Delayed cut-out AC	65	720
Delayed cut-out AC	240	900
Delayed cut-in AC	65	520
Delayed cut-in AC	240	810

Function description

ON delay

When voltage is applied to terminals 17 and A2, the set time interval begins. When the set time elapses, terminal 18 is powered and the contactor is energised. When voltage to the Clip-on timer is disconnected, the contactor drops out.

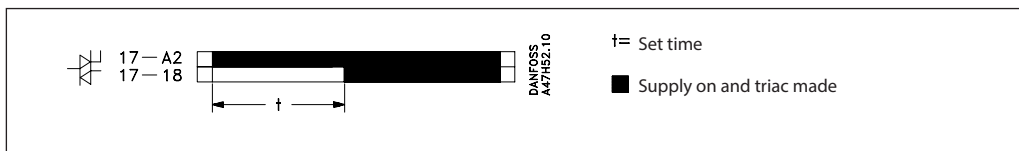

OFF delay

Voltage is applied to terminals A1 and A2. When terminal 15 receives voltage, terminal 16 is powered and the contactor is energised. When terminal 15 is disconnected, the time interval begins. When the time interval elapses, the contactor is de-energised. If voltage to A1 – A2 is cut off, the contactor drops out.

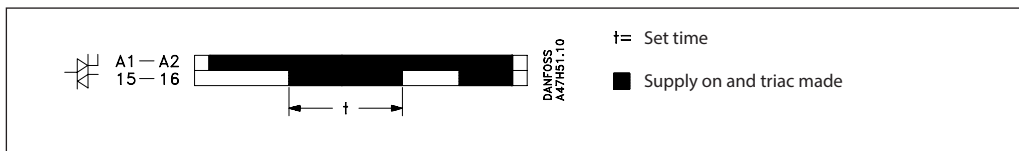

Dimensions

Control relays, contactors and motor starters, CI 6, 9, 12, 15
Drilling dimensions

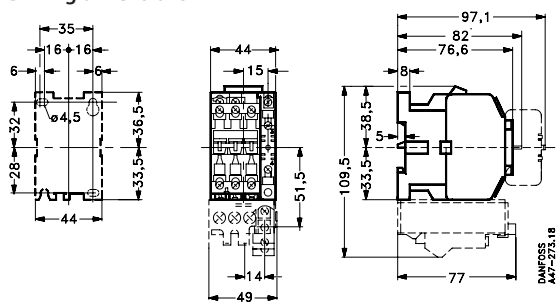

CI 6 – CI 30 with mechanical interlock
Drilling dimensions

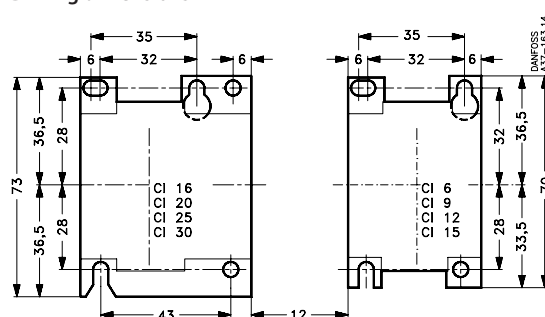

Contactors and motor starters CI 16, 20, 25, 30
Drilling dimensions

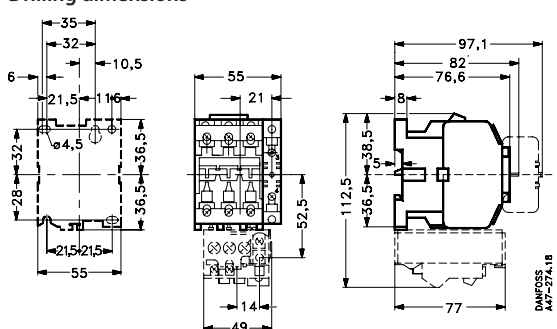

Contactors and motor starters CI 32, 37, 45, 50
Drilling dimensions

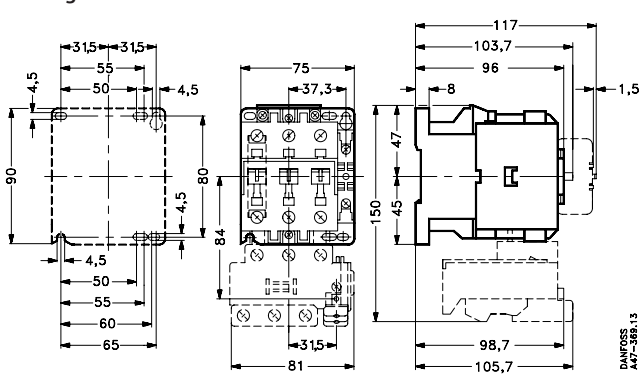

CI 32 – CI 50 with mechanical interlock
Drilling dimensions

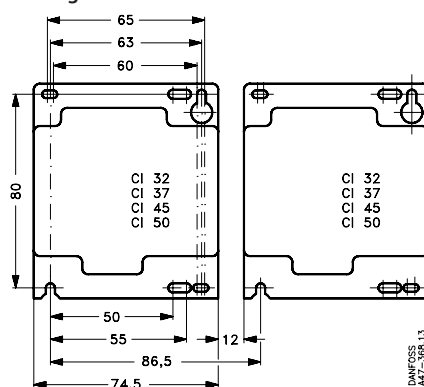

Contactors and motor starters CI 9EI, 15EI, 9DC, 15DC

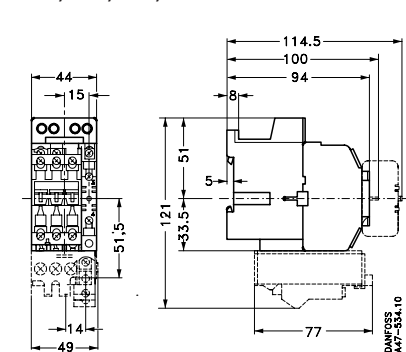

Contactors and motor starters CI 25EI, 30 EI, 25DC, 30DC

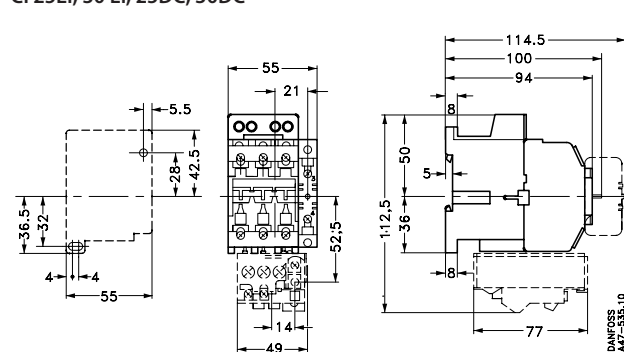

Dimensions, Accessories

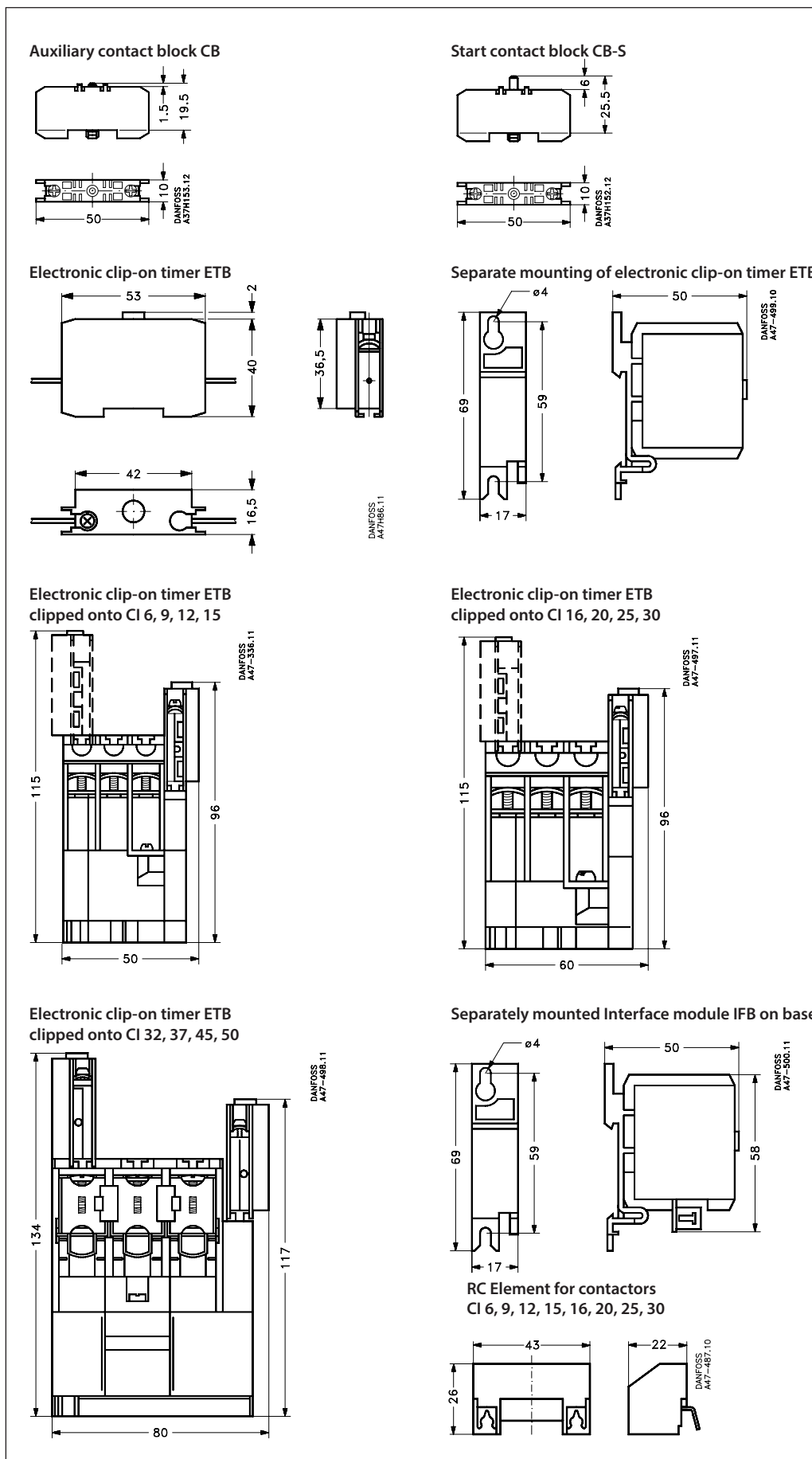

Dimensions
Thermal overload relays
TI 16C – TI 30C

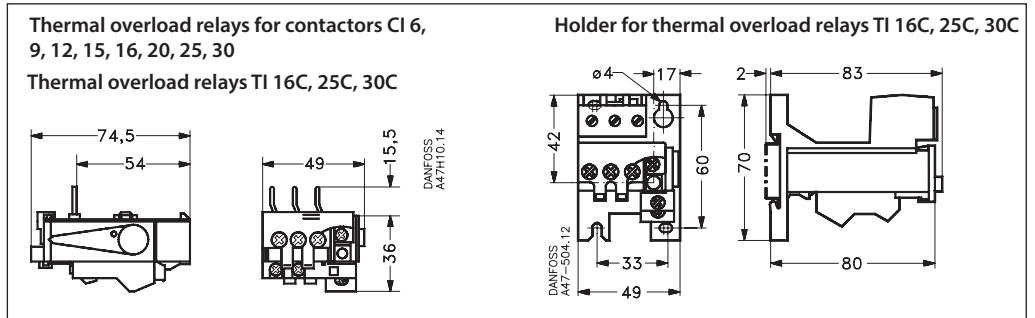

Dimensions
Thermal overload relays
TI 80

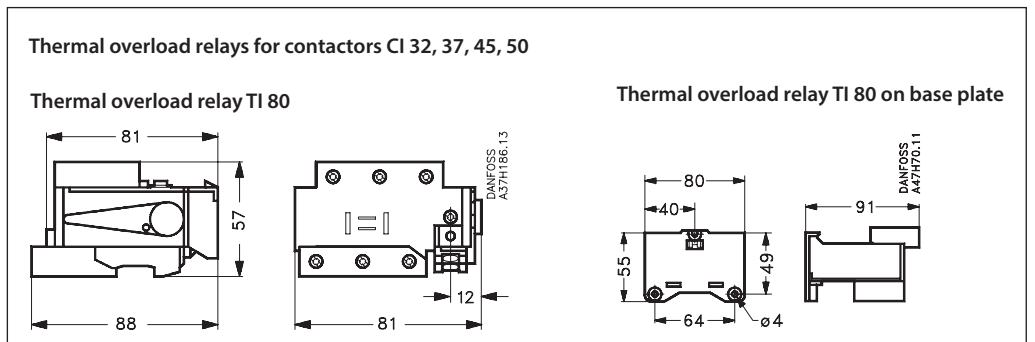

Enclosures

Plastic enclosure BCI, BCI 1, BCI 2
for contactors CI 6, 9, 12, 15, 16, 20, 25, 30

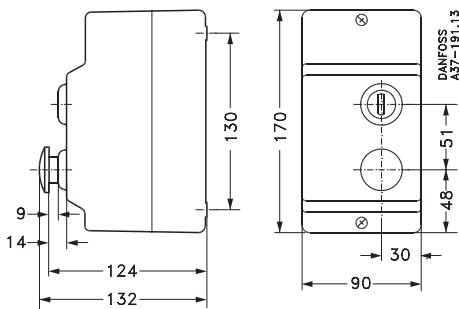

Flush-mounted metal enclosure CITEF 2
for contactors CI 6, 9, 12, 15, 16

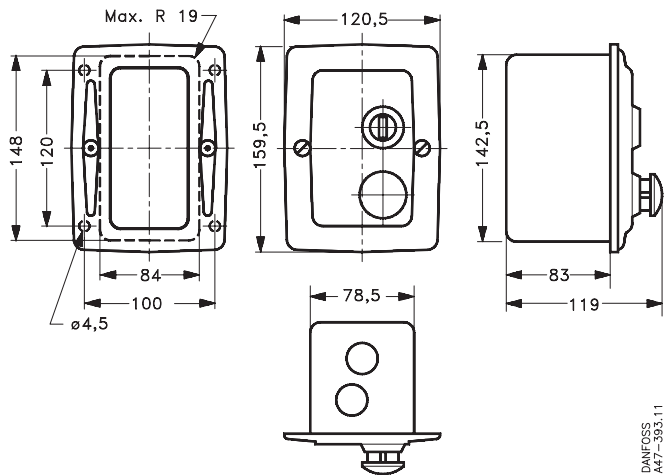

X-ON Electronics

Largest Supplier of Electrical and Electronic Components

Click to view similar products for [Industrial Relays](#) category:

Click to view products by [Danfoss](#) manufacturer:

Other Similar products are found below :

[6-1618400-7](#) [686-117111](#) [686-120111](#) [EV250-4A-02](#) [EV250-6A-01](#) [FCA-125-CX8](#) [FCA-410-138](#) [8-1618393-1](#) [GCA32A208VAC60HZ](#)
[GCA32A220VAC50/60HZ](#) [GCA32A230VAC50/60HZ](#) [GCA32A240VAC50/60HZ](#) [GCA32A48VAC60HZ](#) [GCA63A120VAC50/60HZ](#)
[GCA63A208VAC60HZ](#) [GCA63A220VAC60HZ](#) [GCA63A230VAC50/60HZ](#) [GCA63A240VAC50/60HZ](#) [GCA63A277VAC60HZ](#)
[GCA63A48VAC60HZ](#) [GCA63A500VAC50/60HZ](#) [GCA63A600VAC60HZ](#) [GCA800A200VACDC](#) [GCA95A110VAC50/60HZ](#)
[GCA95A120VAC50/60HZ](#) [GCA95A12VDC](#) [GCA95A240VAC50/60HZ](#) [GCA95A24VAC50/60HZ](#) [GCA95A48VAC60HZ](#) [ACC530U20](#)
[ACC730U30](#) [1395832-1](#) [RM699BV-3011-85-1005](#) [RMIA210230AC](#) [RMIA45024AC](#) [1423675-8](#) [B07B032AC1-0329](#) [B329](#) [1617807-1](#)
[N417](#) [P25-E5019-1](#) [P30C42A12D1-120](#) [2-1618398-1](#) [PBO-18A1218](#) [2307497](#) [RPYA00324LT](#) [RPYA003A120LT](#) [KR-4539-1](#)
[RT334012WG](#) [S160156115](#)