

A Professional MLCC (Multi-Layer Ceramic Capacitor) Manufacturer

In the post-PC 21st century, all information and communication technology products will be closely connected with our daily lives. In a colorful communication world, DARFON's Multi-layer Ceramic Capacitor is significant. This product addresses the market's application needs by combining technology from materials engineering, chemical engineering, electronic engineering, and mechanical engineering.

A Multi-layer Ceramic Capacitor with different functions is always the goal of DARFON's R&D, with R&D taking the direction of multi-levels and small scale. As far as the technical aspect is concerned, the company has surpassed other domestic companies in Taiwan by being first to develop the BME process and 0201 ultra miniature MLCC. This product's ultra thin thickness is top notch.

Through automated equipment with high efficient management systems, DARFON can guarantee the quality of each end product.

DARFON Quality Policy

**“ To deliver Defect-free, Competitive Products
and Services to our Customers on time. “**

MLCC Introduction

Multi-layer ceramic capacitors (MLCC) are manufactured by suspending ceramic powders in liquid and casting into a thin green sheet from 20 um in thickness to 5 um or thinner.

Metal electrodes are sieved printed onto green sheets, which are later stacked to form a laminated structure. The metal electrodes are arranged so that the termination alternates from one edge to another of the capacitor.

Upon sintering at high temperature the part becomes a monolithic block, which can provide an extremely high capacitance in small mechanical volumes.

Finally, the termination electrodes are formed by composite of outer metal-glass electrode and followed by a barrier layer and pure-tin plating to permit MLCC to be soldered directly onto printed circuit board.

● SELECTION GUIDE OF MULTILAYER CERAMIC CAPACITOR	3
● ORDERING INFORMATION	6
● STRUCTURE AND DIMENSIONS	7
● PRODUCT RANGE AND THICKNESS	8
● ELECTRICAL SPECIFICATIONS	
● General Purpose	13
● NP0 High Frequency Type	16
● TYPICAL CHARACTERISTICS CURVES	17
● RF CHARACTERISTICS OF NPO Q series	19
● PACKAGING	22
● APPLICATION NOTES	26
● ENVIRONMENTAL CONCERNS	34

Darfon's series of Multilayer Ceramic Chip Capacitors are designed to meet a wide variety of needs. We offer a complete range of products for both general and specialized applications in the industry. We suggest your selection of capacitors based on consideration of the following items:

1. DIELECTRIC TYPE

The choice of dielectric is usually determined by the required capacitance-temperature stability. Darfon offers four types, NP0, X7R, X5R and Y5V for your choice. The features and applications of these four types are specified as follows:

Dielectric	NP0	X7R/X5R	Y5V
Features	<ol style="list-style-type: none"> 1. Ultra-stable 2. Tight tolerance available 3. Low ESR 4. Good frequency performance 5. No aging of capacitance 	<ol style="list-style-type: none"> 1. Semi-stable and High K 2. High volumetric efficiency 3. Highly reliable in high temperature application 4. High insulation resistance 	<ol style="list-style-type: none"> 1. High volumetric efficiency 2. Non-polar construction 3. General purpose, High K
Applications	<ol style="list-style-type: none"> 1. LC and RC tuned circuit 2. Filtering 3. Timing 	<ol style="list-style-type: none"> 1. Blocking 2. Coupling 3. Timing 4. Bypassing 5. Frequency discriminating 6. Filtering 	<ol style="list-style-type: none"> 1. Bypassing 2. De-coupling 3. Filtering

2. CAPACITANCE AND TOLERANCE

Capacitance and its tolerance are determined by circuit requirement and cost consideration.

■ E Standard Number

E 3	1.0				2.2				4.7															
E 6	1.0		1.5		2.2		3.3		4.7		6.8													
E12	1.0	1.2	1.5	1.8	2.2	2.7	3.3	3.9	4.7	5.6	6.8	8.2												
E24	1.0	1.1	1.2	1.3	1.5	1.6	1.8	2.0	2.2	2.4	2.7	3.0	3.3	3.6	3.9	4.3	4.7	5.1	5.6	6.2	6.8	7.5	8.2	9.1

* Non-standard capacitance is available on request.

■ Available Tolerance

T. C.	Capacitance *	Standard Tolerance	Available Tolerance on Request
NP0 (C0G)	Cap < 5pF	C = ± 0.25pF D = ± 0.5pF	B = ± 0.1pF
	5pF ≤ Cap < 10pF	D = ± 0.5pF	B = ± 0.1pF C = ± 0.25pF
	Cap ≥ 10pF	J = ± 5% K = ± 10%	F = ± 1% G = ± 2%
X5R X7R	All	K = ± 10% M = ± 20%	J = ± 5%
Y5V	All	Z = -20% to +80%	M = ± 20%

* Non-standard capacitance or tolerance is available on request.

3. RATED VOLTAGE

Rated voltage is determined by circuit requirement.

4. PACKAGING

Specify the packaging of capacitors as bulk or tape and reeled.

5. PRODUCT RANGE AND SIZE

● NP0 (Class I)

Type		Size				
T.C.	RV	0603 (0201)	1005 (0402)	1608 (0603)	2012 (0805)	3216 (1206)
NP0 Class I	16V			2.7nF~3.3nF		12nF~39nF
	25V	0.20pF~100pF	0.20pF~22pF			
	50V	0.20pF~18pF	0.20pF~470pF/1nF	0.20pF~2.2nF	0.50pF~10nF	1.50pF~10nF
	100V		0.20pF~220pF	0.20pF~1nF	0.50pF~3.3nF	1.50pF~4.7nF

- **X7R (Class II)**

Type		Size					
T.C.	RV	0603 (0201)	1005 (0402)	1608 (0603)	2012 (0805)	3216 (1206)	3225 (1210)
X7R Class II	6.3V				4.7uF~10uF		
	10V	3.3nF/4.7nF/10nF	100pF~100nF	100pF~1uF	1uF/2.2uF/4.7uF/10uF	2.2uF	
	16V		100pF~100nF	100pF~1uF	330nF/470nF/1uF/ 2.2uF	470nF~10uF	10uF
	25V	100pF~2.2nF	100pF~22nF	100pF~1uF	1nF~1uF	220nF~4.7uF	4.7uF/10uF
	50V	100pF~2.2nF	100pF~10nF	100pF~100nF	150pF~470nF	1nF~1uF	
	100V			100pF~10nF	150pF~22nF	1nF~100nF	

- **X5R (Class II)**

Type		Size					
T.C.	RV	0603 (0201)	1005 (0402)	1608 (0603)	2012 (0805)	3216 (1206)	3225 (1210)
X5R Class II	6.3V	2.2nF~220nF	470nF~4.7uF	2.2uF/ 4.7uF/10uF	4.7uF~22uF	22uF/47uF	47uF/100uF
	10V	2.2nF~100nF	15nF~1uF	220nF~4.7uF	2.2uF~10uF	2.2uF~10uF	22uF
	16V		15nF~1uF	220nF~2.2uF	1uF~10uF	2.2uF~10uF	4.7uF~22uF
	25V		100nF	220nF/1uF	1uF~4.7uF	2.2uF~10uF	4.7uF/ 10uF

- **Y5V (Class II)**

Type		Size			
T.C.	RV	0603 (0201)	1005 (0402)	1608 (0603)	2012 (0805)
Y5V Class II	6.3V	22nF~100nF	10nF~1uF	10nF~2.2uF	
	10V		10nF~1uF	10nF~2.2uF	
	16V		10nF~220nF	10nF~2.2uF	100nF~2.2uF
	25V		10nF~100nF	10nF~330nF	100nF ~2.2uF
	50V		10nF~33nF	10nF~220nF	100nF~1uF

Note : (1) Other size, capacitance, and voltage are available upon customer's request.

(2) Product range might be extended due to technology improvement or new product released : for up-to-date information, please contact our sales.

(3) Part of Y5V product will be phased out.

DARFON Part Number

C 1005 NP0 101 J G T S

PRODUCT CODE

C = Capacitor SMD

SIZE in mm (EIA CODE, in inch)

0402(01005)	0603(0201)	1005 (0402)	1608 (0603)	2012 (0805)
3216 (1206)	3225(1210)	4520 (1808)	4532 (1812)	

T. C.

NP0: 0 ± 30ppm/°C	-55°C to +125°C
X7R: ±15%	-55°C to +125°C
X5R: ±15%	-55°C to +85°C
Y5V: +22%/-82%	-30°C to +85°C

CAPACITANCE CODE

Expressed in pico-farads and identified by a three-digit number.
 First two digits represent significant figures.
 Last digit specifies the number of zeros.
 (Use 9 for 1.0 through 9.9pF ; Use 8 for 0.2 through 0.99pF)
 (Example: 2.2pF=229 or 0.47pF=478)

TOLERANCE CODE

A: ± 0.05pF	B: ± 0.1pF	C: ± 0.25pF	D: ± 0.5pF	F: ±1%	G: ±2%
J: ±5%	K: ±10%	M: ±20%	Z: +80/-20%		

VOLTAGE CODE

B: 4V	C: 6.3V	D: 10V	E: 16V	F: 25V	N: 35V	G: 50V	H: 100V
J: 200V	K: 250V	L: 500V	M: 630V	P: 1KV	Q: 2KV	R: 3KV	S: 4KV

PACKAGING CODE

T: Paper tape reel Ø180mm (7")	P: Embossed tape reel Ø180mm (7")
N: Paper tape reel Ø250mm (10")	D: Embossed tape reel Ø250mm (10")
A: Paper tape reel Ø330mm (13")	E: Embossed tape reel Ø330mm (13")
B: Bulk, loosed in bag	C: Bulk cassette
W: Special Packing	

Product Type

S: Standard Ceramic Capacitor
 Q: High Q/Low ESR

MLCC STRUCTURE

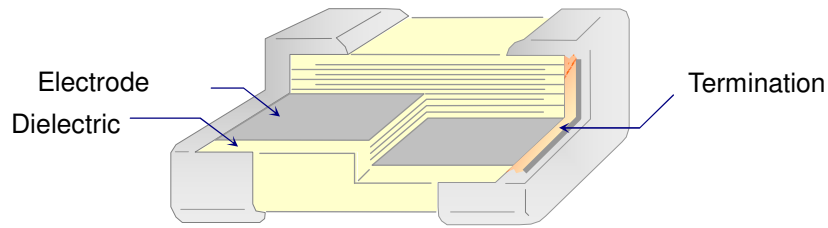

DIMENSIONS

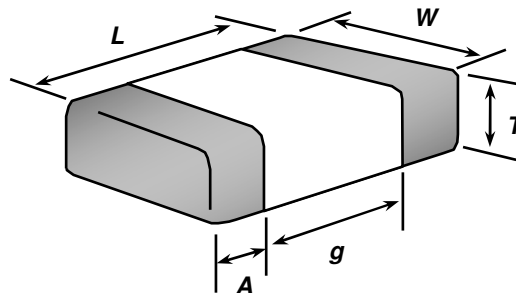

TYPICAL TOLERANCE

SIZE CODE (EIA)	L (Length)	W (Width)	T (Max Thickness)	g (Min)	A (Termination Min/Max)	UNIT
0603 (0201)	0.6+/-0.03 (0.024+/-0.001)	0.3+/-0.03 (0.012+/-0.001)	0.33 (0.013)	0.15 (0.006)	0.10/0.20 (0.004/0.008)	mm (inch)
1005 (0402)	1.0 +/- 0.05 (0.040 +/- 0.002)	0.5 +/- 0.05 (0.020 +/- 0.002)	0.55 (0.022)	0.30 (0.012)	0.10 / 0.30 (0.004 / 0.012)	mm (inch)
1608 (0603)	1.6 +/- 0.10 (0.063 +/- 0.004)	0.8 +/- 0.10 (0.031 +/- 0.004)	0.90 (0.035)	0.50 (0.020)	0.25 / 0.65 (0.010 / 0.026)	mm (inch)
2012 (0805)	2.0 +/- 0.15 (0.079 +/- 0.006)	1.25 +/- 0.20 (0.049 +/- 0.008)	1.45 (0.057)	0.70 (0.028)	0.25 / 0.75 (0.010 / 0.030)	mm (inch)
3216 (1206)	3.2 +/- 0.15 (0.126 +/- 0.006)	1.6 +/- 0.20 (0.063 +/- 0.008)	1.80 (0.069)	1.50 (0.060)	0.25 / 0.75 (0.010 / 0.030)	mm (inch)
3225 (1210)	3.2 +/- 0.20 (0.126 +/- 0.008)	2.5 +/- 0.20 (0.098 +/- 0.008)	2.70 (0.106)	1.50 (0.060)	0.25 / 0.75 (0.010 / 0.030)	mm (inch)

SPECIAL TOLERANCE

SIZE CODE (EIA)	L (Length)	W (Width)	T (Max Thickness)	g (Min)	A (Termination Min/Max)	UNIT
1005* (0402)	1.0 +/- 0.15 (0.040 +/- 0.006)	0.5 +/- 0.15 (0.020 +/- 0.006)	0.65 (0.026)	0.30 (0.012)	0.10 / 0.30 (0.004 / 0.012)	mm (inch)
1608* (0603)	1.6 + 0.15/-0.1 (0.063 +0.006/- 0.004)	0.8 + 0.15/-0.1 (0.031 +0.006/-0.004)	0.95 (0.037)	0.50 (0.020)	0.25 / 0.65 (0.010 / 0.026)	mm (inch)
2012* (0805)	2.0 +/- 0.20 (0.079 +/- 0.008)	1.25 +0.30/-0.20 (0.049 +0.012/ -0.008)	1.55 (0.061)	0.70 (0.028)	0.25 / 0.75 (0.010 / 0.030)	mm (inch)
3216* (1206)	3.2 +/- 0.20 (0.126 +/- 0.008)	1.6 +0.30/-0.20 (0.063 +0.012/ -0.008)	1.90 (0.075)	1.50 (0.060)	0.25 / 0.75 (0.010 / 0.030)	mm (inch)
3225* (1210)	3.2 +/- 0.30 (0.126 +/- 0.012)	2.5 +/- 0.30 (0.098 +/- 0.012)	2.80 (0.11)	1.50 (0.060)	0.25 / 0.75 (0.010 / 0.030)	mm (inch)

NP0 - General Purpose

CLASS	Class I											
TYPE	Standard											
T.C.	COG (NP0)											
SIZE	0603		1005		1608			2012		3216		
(EIA)	0201		0402		0603			0805		1206		
RV	25V	50V	50V	100V	16V	50V	100V	50V	100V	16V	50V	100V
0.20 p			B	B		D	D					
0.50 p	A	A	B	B		D	D	C	C			
0.75 p	A	A	B	B		D	D	C	C			
1.0 p	A	A	B	B		D	D	C	C			
1.2 p	A	A	B	B		D	D	C	C			
1.5 p	A	A	B	B		D	D	C	C		E	E
1.8 p	A	A	B	B		D	D	C	C		E	E
2.2 p	A	A	B	B		D	D	C	C		E	E
2.7 p	A	A	B	B		D	D	C	C		E	E
3.3 p	A	A	B	B		D	D	C	C		E	E
3.9 p	A	A	B	B		D	D	C	C		E	E
4.7 p	A	A	B	B		D	D	C	C		E	E
5.6 p	A	A	B	B		D	D	C	C		E	E
6.8 p	A	A	B	B		D	D	C	C		E	E
8.2 p	A	A	B	B		D	D	C	C		E	E
10 p	A	A	B	B		D	D	C	C		E	E
12 p	A	A	B	B		D	D	C	C		E	E
15 p	A	A	B	B		D	D	C	C		E	E
18 p	A	A	B	B		D	D	C	C		E	E
22 p	A		B	B		D	D	C	C		E	E
27 p	A		B	B		D	D	C	C		E	E
33 p	A		B	B		D	D	C	C		E	E
39 p	A		B	B		D	D	C	C		E	E
47 p	A		B	B		D	D	C	C		E	E
56 p	A		B	B		D	D	C	C		E	E
68 p	A		B	B		D	D	C	C		E	E
82 p	A		B	B		D	D	C	C		E	E
100 p	A		B	B		D	D	C	C		E	E
120 p			B	B		D	D	C	C		E	E
150 p			B	B		D	D	C	C		E	E
180 p			B	B		D	D	C	C		E	E
220 p			B	B		D	D	C	C		E	E
270 p			B			D	D	C	C		E	E
330 p			B			D	D	C	C		E	E
390 p			B			D	D	C	E		E	E
470 p			B			D	D	C	E		E	E
560 p						D	D	C	E		E	E
680 p						D	D	C	E		E	E
820 p						D	D	C	E		E	E
1.0 n			B			D	D	C	E		E	E
1.2 n						D*		E	E		E	E
1.5 n						D*		E	E		E	E
1.8 n						D*		E	E		E	E
2.2 n						D*		E	E		E	E
2.7 n						D*		G	G		E	E
3.3 n						D*		G	G		E	E
3.9 n								G			E	E
4.7 n								G			E	E
5.6 n								G			E	
6.8 n								G			F	
8.2 n								G			F	
10 n								G			G	
12 n										G		
15 n										G		
18 n										G		
22 n										G		
27 n										G		
33 n										G		
39 n										L		

Note : Thickness might be changed due to technology improvement.

NP0 – Low ESR/ High Q (Q Series)

CLASS	Class I					
TYPE	Low ESR/High Q					
T.C.	NP0(COG)					
SIZE	0603		1005		1608	
(EIA)	0201		0402		0603	
RV	25V	50V	25V	50V	25V	50V
* 0.20 p	A	A	B	B	D	D
* 0.50 p	A	A	B	B	D	D
* 0.75 p	A	A	B	B	D	D
1.0 p	A	A	B	B	D	D
1.2 p	A	A	B	B	D	D
1.5 p	A	A	B	B	D	D
1.8 p	A	A	B	B	D	D
2.2 p	A	A	B	B	D	D
2.7 p	A	A	B	B	D	D
3.3 p	A	A	B	B	D	D
3.9 p	A	A	B	B	D	D
4.7 p	A	A	B	B	D	D
5.6 p	A	A	B	B	D	D
6.8 p	A	A	B	B	D	D
8.2 p	A	A	B	B	D	D
10 p	A	A	B	B	D	D
12 p	A	A	B	B	D	D
15 p	A	A	B	B	D	D
18 p	A	A	B	B	D	D
22 p			B	B	D	D
27 p						
33 p						
39 p						
47 p						
56 p						
68 p						
82 p						
100 p						
120 p						
150 p						
180 p						
220 p						
270 p						
330 p						

Note : Thickness might be changed due to technology improvement.

Thickness Tolerance

Thickness (mm)		Thickness (mm)		Thickness (mm)		Thickness (mm)		Thickness (mm)		Thickness (mm)	
Code	Class	Code	Class	Code	Class	Code	Class	Code	Code	Code	Code
A	0.30+/-0.03	C	0.60+/-0.15	E	0.85+/-0.15	G	1.25+0.3/-0.20	L	1.60+0.3/-0.20	P	2.50+/-0.20
B	0.50+/-0.05	D	0.80+/-0.10	F	1.15+/-0.20	I	0.95+/-0.15	N	2.00+/-0.20	Q	0.45+/-0.05
B	0.50+/-0.15	D	0.8+0.15/-0.1	G	1.25+/-0.20	L	1.60+/-0.20	N	2.00+/-0.30		

Special Length/Width Tolerance

Size Code(EIA)	1005(0402)	1608(0603)	2012(0805)	3216(1206)	3225(1210)
Length(mm)	1.0 ± 0.15	1.6 ± 0.15	2.0 ± 0.20	3.2 ± 0.20	3.2 ± 0.30
Width(mm)	0.5 ± 0.15	0.8 ± 0.15	1.25 ± 0.30	1.6 ± 0.30	2.5 ± 0.30

X5R – General Purpose

CLAS	Class II																									
TYPE	Standard																									
T.C.	X5R																									
SIZE	0603		1005				1608				2012				3216				3225							
(EIA)	0201		0402				0603				0805				1206				1210							
RV	6.3V	10V	6.3V	10V	16V	25V	6.3V	10V	16V	25V	6.3V	10V	16V	25V	6.3V	10V	16V	25V	6.3V	10V	16V	25V				
2.2 n	A	A																								
3.3 n	A	A																								
4.7 n	A	A																								
5.6 n	A	A																								
6.8 n	A	A																								
8.2 n	A	A																								
10 n	A	A																								
15 n				B	B																					
22 n	A	A		B	B																					
33 n				B	B																					
47 n	A	A		B	B																					
56 n				B	B																					
68 n				B	B																					
82 n				B	B																					
100 n	A	A		B	B	B																				
120 n				B	B																					
150 n				B	B																					
180 n				B	B																					
220 n	A			B	B			D	D	D																
270 n																										
330 n								D	D																	
390 n																										
470 n			B	B				D	D																	
560 n																										
680 n								D	D																	
820 n																										
1.0 u			B	B	B			Q	D	Q	D	Q	D			E	G	E	G							
1.5 u																										
1.8 u																										
2.2 u			B					D	D	D						E	G	G		L	L	L				
2.7 u																										
3.3 u																										
3.9 u																										
4.7 u			B*					D	D				G	G	G	G			L	L	L	N	N			
6.8 u																										
10 u								D*					G	G	G				L	L	L		N	N		
22 u													G						L	L	L		N	P	N	P
47 u																			L				P			
100 u																							P			

- Non-standard capacitance or thickness is available on request
- * Special length/width tolerance
- The thickness might be changed due to technology improvement.

Thickness Tolerance

Thickness (mm)	Thickness (mm)	Thickness (mm)	Thickness (mm)	Thickness (mm)	Thickness (mm)
Code	Class	Code	Class	Code	Class
A	0.30+/-0.03	C	0.60+/-0.15	E	0.85+/-0.15
B	0.50+/-0.05	D	0.80+/-0.10	F	1.15+/-0.20
B	0.50+/-0.15	D	0.8+0.15/-0.1	G	1.25+/-0.20
				L	1.60+/-0.20
				N	2.00+/-0.20
				N	2.00+/-0.30
				P	2.50+/-0.20
				Q	0.45+/-0.05

Special Length/Width Tolerance

Size Code(EIA)	1005(0402)	1608(0603)	2012(0805)	3216(1206)	3225(1210)
Length(mm)	1.0 ± 0.15	1.6 ± 0.15	2.0 ± 0.20	3.2 ± 0.20	3.2 ± 0.30
Width(mm)	0.5 ± 0.15	0.8 ± 0.15	1.25 ± 0.30	1.6 ± 0.30	2.5 ± 0.30

CLASS	Class II																									
TYPE	Standard																									
T.C.	X7R																									
SIZE (EIA)	0603					1005				1608					2012					3216					3225	
	0201			0402				0603					0805					1206					1210			
RV	10V	25V	50V	10V	16V	25V	50V	10V	16V	25V	50V	100V	6.3V	10V	16V	25V	50V	100V	10V	16V	25V	50V	100V	16V	25V	
100 p	A	A	B	B	B	B	B	D	D	D	D	D														
120 p	A	A	B	B	B	B	B	D	D	D	D	D														
150 p	A	A	B	B	B	B	B	D	D	D	D	D								C	E	E				
180 p	A	A	B	B	B	B	B	D	D	D	D	D								C	E	E				
220 p	A	A	B	B	B	B	B	D	D	D	D	D								C	E	E				
270 p	A	A	B	B	B	B	B	D	D	D	D	D								C	E	E				
330 p	A	A	B	B	B	B	B	D	D	D	D	D								C	E	E				
390 p	A	A	B	B	B	B	B	D	D	D	D	D								C	E	E				
470 p	A	A	B	B	B	B	B	D	D	D	D	D								C	E	E				
560 p	A	A	B	B	B	B	B	D	D	D	D	D								C	E	E				
680 p	A	A	B	B	B	B	B	D	D	D	D	D								C	E	E				
820 p	A	A	B	B	B	B	B	D	D	D	D	D								C	E	E				
1.0 n	A	A	B	B	B	B	B	D	D	D	D	D				C	E	C	E	E			E	E		
1.2 n	A	A	B	B	B	B	B	D	D	D	D	D				C	E	C	E	E			E	E		
1.5 n	A	A	B	B	B	B	B	D	D	D	D	D				C	E	C	E	E			E	E		
1.8 n	A	A	B	B	B	B	B	D	D	D	D	D				C	E	C	E	E			E	E		
2.2 n	A	A	B	B	B	B	B	D	D	D	D	D				C	E	C	E	E			E	E		
2.7 n			B	B	B	B	B	D	D	D	D	D				C	E	C	E	E			E	E		
3.3 n	A		B	B	B	B	B	D	D	D	D	D				C	E	C	E	E			E	E		
3.9 n			B	B	B	B	B	D	D	D	D	D				C	E	C	E	E			E	E		
4.7 n	A		B	B	B	B	B	D	D	D	D	D				C	E	C	E	E			E	E		
5.6 n			B	B	B	B	B	D	D	D	D	D				C	E	C	E	E			E	E		
6.8 n			B	B	B	B	B	D	D	D	D	D				C	E	C	E	E			E	E		
8.2 n			B	B	B	B	B	D	D	D	D	D				C	E	C	E	E			E	E		
10 n	A		B	B	B	B	B	D	D	D	D	D				C	E	C	E	E			E	E		
12 n			B	B	B	B	B	D	D	D	D	D				C	E	C	E	E			E	E		
15 n			B	B	B	B	B	D	D	D	D	D				C	E	C	E	E			E	E		
18 n			B	B	B	B	B	D	D	D	D	D				C	E	C	E	E			E	E		
22 n			B	B	B	B	B	D	D	D	D	D				C	E	C	E	E			E	E		
27 n			B	B	B	B	B	D	D	D	D	D				C	E	C	E	E			E	E		
33 n			B	B	B	B	B	D	D	D	D	D*				C	E	C	E	E			E	E		
39 n			B	B	B	B	B	D	D	D	D	D*				C	E	C	E	E			E	E		
47 n			B	B	B	B	B	D	D	D	D	D*				E	E	E	E	E			E	E		
56 n			B	B	B	B	B	D	D	D	D	D*				E	E	E	E	E			E	E		
68 n			B	B	B	B	B	D	D	D	D	D*				E	E	E	E	E			E	E		
82 n			B	B	B	B	B	D	D	D	D	D*				E	E	E	E	E			E	E		
100 n			B	B	B	B	B	D	D	D	D	D*				E	E	E	E	E			E	E		
120 n																E	E	E	E	E						
150 n																E	E	E	E	E						
180 n																E	E	E	E	E						
220 n								D	D	D*						E	E	E	E	E		I	I			
270 n																										
330 n								D*	D*						G	G	G					I	G			
390 n																										
470 n								D*	D*						G	G	G					G	G	L		
560 n																										
680 n																										
820 n																										
1.0 u								D*	D*	D*				G	G	G						G	G	G	L	
1.2 u																										
1.5 u																										
1.8 u																										
2.2 u														G	G							L	L	L		
2.7 u																										
3.3 u																										
3.9 u																										
4.7 u														G	G							L	L		N	
10 u														G								L			N	

- Non-standard capacitance or thickness is available on request
- * Special length/width tolerance
- The thickness might be changed due to technology improvement.

Thickness Tolerance

Thickness (mm)		Thickness (mm)		Thickness (mm)		Thickness (mm)		Thickness (mm)		Thickness (mm)	
Code	Class	Code	Class	Code	Class	Code	Class	Code	Class	Code	Class
A	0.30+/-0.03	C	0.60+/-0.15	E	0.85+/-0.15	G	1.25+0.3/-0.20	L	1.60+0.3/-0.20	P	2.50+/-0.20
B	0.50+/-0.05	D	0.80+/-0.10	F	1.15+/-0.20	I	0.95+/-0.15	N	2.00+/-0.20	Q	0.45+/-0.05
B	0.50+/-0.15	D	0.8+0.15/-0.1	G	1.25+/-0.20	L	1.60+/-0.20	N	2.00+/-0.30		

Special Length/Width Tolerance

Size Code(EIA)	1005(0402)	1608(0603)	2012(0805)	3216(1206)	3225(1210)
Length(mm)	1.0 ± 0.15	1.6 ± 0.15	2.0 ± 0.20	3.2 ± 0.20	3.2 ± 0.30
Width(mm)	0.5 ± 0.15	0.8 ± 0.15	1.25 ± 0.30	1.6 ± 0.30	2.5 ± 0.30

Y5V – General Purpose

CLASS	Class II														
TYPE	Standard														
T.C.	Y5V														
SIZE	0603		1005					1608					2012		
(EIA)	0201		0402					0603					0805		
RV	6.3V	10V	6.3V	10V	16V	25V	50V	6.3V	10V	16V	25V	50V	16V	25V	50V
10 n			B	B	B	B	B	D	D	D	D	D			
12 n			B	B	B	B	B	D	D	D	D	D			
15 n			B	B	B	B	B	D	D	D	D	D			
18 n			B	B	B	B	B	D	D	D	D	D			
22 n	A	A	B	B	B	B	B	D	D	D	D	D			
27 n			B	B	B	B	B	D	D	D	D	D			
33 n	A	A	B	B	B	B	B	D	D	D	D	D			
39 n			B	B	B	B		D	D	D	D	D			
47 n	A	A	B	B	B	B		D	D	D	D	D			
56 n			B	B	B			D	D	D	D	D			
68 n			B	B	B			D	D	D	D	D			
82 n			B	B	B			D	D	D	D	D			
100 n	A	A	B	B	B	B		D	D	D	D	D	C	C	C
120 n															
150 n															
180 n															
220 n			B	B	B			D	D	D	D	D	E	E	E
270 n															
330 n			B	B				D	D	D	D				
390 n															
470 n			B	B				D	D	D			E	E	E
560 n															
680 n															
820 n															
1.0 u			B	B				D*	D*	D*			E	G	G
1.2 u															
1.5 u															
1.8 u															
2.2 u								D	D	D			E	G	
2.7 u															
3.3 u															
3.9 u															
4.7 u															
5.6 u															
6.8 u															
8.2 u															
10 u															

- Non-standard capacitance or thickness is available on request
- * Special length/width tolerance
- The thickness might be changed due to technology improvement.
- Part of Y5V product will be phased out.

Thickness Tolerance

Thickness (mm)		Thickness (mm)		Thickness (mm)		Thickness (mm)		Thickness (mm)		Thickness (mm)	
Code	Class	Code	Class	Code	Class	Code	Class	Code	Code	Code	Code
A	0.30+/-0.03	C	0.60+/-0.15	E	0.85+/-0.15	G	1.25+0.3/-0.20	L	1.60+0.3/-0.20	P	2.50+/-0.20
B	0.50+/-0.05	D	0.80+/-0.10	F	1.15+/-0.20	I	0.95+/-0.15	N	2.00+/-0.20	Q	0.45+/-0.05
<u>B</u>	0.50+/-0.15	<u>D</u>	0.8+0.15/-0.1	G	1.25+/-0.20	L	1.60+/-0.20	N	2.00+/-0.30		

Special Length/Width Tolerance

Size Code(EIA)	1005(0402)	1608(0603)	2012(0805)	3216(1206)	3225(1210)
Length(mm)	1.0 ± 0.15	1.6 ± 0.15	2.0 ± 0.20	3.2 ± 0.20	3.2 ± 0.30
Width(mm)	0.5 ± 0.15	0.8 ± 0.15	1.25 ± 0.30	1.6 ± 0.30	2.5 ± 0.30

General Purpose

Item	Specification		Test Method																																									
	Temp. compensating type	High dielectric constant type																																										
1 Operating Temperature Range	NP0: -55 to 125 degree C	X7R: -55 to 125 degree C X5R: -55 to 85 degree C Y5V: -30 to 85 degree C	---																																									
2 Rated Voltage	4VDC, 6.3VDC, 10VDC, 16VDC, 25VDC, 35VDC, 50VDC, 100VDC, 200VDC, 250VDC, 500VDC, 630VDC, 1000VDC, 2000VDC, 3000VDC		The rated voltage is defined as the maximum voltage, which may be applied continuously to the capacitor.																																									
3 Appearance	No defects or abnormalities.		Visual inspection																																									
4 Dimensions	Within the specified dimension.		Using calipers																																									
5 Dielectric Strength	No defects or abnormalities.		No failure shall be observed when 250%* of the rated voltage (150% for 500V, 120% for above 1KV) is applied between the terminations for 1 to 5 seconds. The charge and discharge current is less than 50mA.																																									
6 Insulation Resistance (I.R.)	Rated Voltage: <500V Rated Voltage: ≥500V	To apply rated voltage. To apply 500V.	I.R. ≥ 10G or R _i C ₀ ≥ 500Ω·F (whichever is smaller)																																									
7 Capacitance	Within the specified tolerance * X7R, X5R and Y5V at 1000 hours		The capacitance / D.F. shall be measured at 25°C at the frequency and voltage shown in the tables.																																									
8 Q/Dissipation Factor (D.F.)	NP0: If C ≤ 30pF, DF ≤ 1/(400+20C), C in pF If C > 30pF, DF ≤ 0.1%.	I. X5R, X7R: See X5R,X7R DF table II. Y5V: See Y5V DF table.	<table border="1"> <thead> <tr> <th>Item</th> <th>Class I C ≤ 1,000pF</th> <th>Class I > 1,000pF</th> </tr> </thead> <tbody> <tr> <td>Frequency</td> <td>1.0±0.2MHz</td> <td>1.0±0.2kHz</td> </tr> <tr> <td>Voltage</td> <td>1.0±0.2Vrms</td> <td>1.0±0.2Vrms</td> </tr> </tbody> </table> <table border="1"> <thead> <tr> <th>Item</th> <th>ClassII (≤ 10 uF)</th> <th>ClassII (> 10 uF)</th> <th>* For item in Table1</th> </tr> </thead> <tbody> <tr> <td>Frequency</td> <td>1.0±0.2kHz</td> <td>120Hz±24Hz</td> <td>1.0±0.2kHz</td> </tr> <tr> <td>Voltage</td> <td>1.0±0.2Vrms</td> <td>0.5±0.1Vrms</td> <td>0.5±0.1Vrms</td> </tr> </tbody> </table> <table border="1"> <caption>Table 1</caption> <thead> <tr> <th>Size</th> <th>Thickness</th> <th>TC</th> <th>RV</th> <th>Cap</th> </tr> </thead> <tbody> <tr> <td>0603</td> <td>0.3 mm</td> <td>X5R</td> <td>6.3V</td> <td>104</td> </tr> <tr> <td>1005</td> <td>0.5 mm</td> <td>X5R</td> <td>4V/6.3V</td> <td>475</td> </tr> <tr> <td>1608</td> <td>0.8 mm</td> <td>X5R</td> <td>4V/6.3V</td> <td>106</td> </tr> </tbody> </table>	Item	Class I C ≤ 1,000pF	Class I > 1,000pF	Frequency	1.0±0.2MHz	1.0±0.2kHz	Voltage	1.0±0.2Vrms	1.0±0.2Vrms	Item	ClassII (≤ 10 uF)	ClassII (> 10 uF)	* For item in Table1	Frequency	1.0±0.2kHz	120Hz±24Hz	1.0±0.2kHz	Voltage	1.0±0.2Vrms	0.5±0.1Vrms	0.5±0.1Vrms	Size	Thickness	TC	RV	Cap	0603	0.3 mm	X5R	6.3V	104	1005	0.5 mm	X5R	4V/6.3V	475	1608	0.8 mm	X5R	4V/6.3V	106
Item	Class I C ≤ 1,000pF	Class I > 1,000pF																																										
Frequency	1.0±0.2MHz	1.0±0.2kHz																																										
Voltage	1.0±0.2Vrms	1.0±0.2Vrms																																										
Item	ClassII (≤ 10 uF)	ClassII (> 10 uF)	* For item in Table1																																									
Frequency	1.0±0.2kHz	120Hz±24Hz	1.0±0.2kHz																																									
Voltage	1.0±0.2Vrms	0.5±0.1Vrms	0.5±0.1Vrms																																									
Size	Thickness	TC	RV	Cap																																								
0603	0.3 mm	X5R	6.3V	104																																								
1005	0.5 mm	X5R	4V/6.3V	475																																								
1608	0.8 mm	X5R	4V/6.3V	106																																								
9 Capacitance Temperature Characteristics	Capacitance change NP0 within 0±30ppm/°C under operating temperature range.	Capacitance change X7R/X5R within ±15% Y5V: -82 to + 22%	<p>1. Temperature compensating type: The capacitance value at 25°C and 85°C shall be measured and calculated from the formula given below. T.C.=(C₈₅-C₂₅)/C₂₅* Δ T*10⁶(PPM/°C)</p> <p>2. High dielectric constant type: The ranges of capacitance change compared with the 25°C value over the temperature ranges shall be within the specified ranges.</p>																																									
10 Termination Strength	No removal of the terminations or marking defect.		Apply a parallel force of 5N to a PCB mounted sample for 10±1sec. *2N for 0603 (EIA 0201).																																									
11 Deflection (Bending Strength)	No cracking or marking defects shall occur at 1mm deflection. Capacitance change: NP0: within ±5% or ± 0.5pF. (whichever is larger) X7R, X5R: within ±12.5% Y5V: within ±20%	(Unit in mm)	<p>Solder the capacitor to the test jig (glass epoxy boards) shown in Fig.a using a SAC305(Sn96.5Ag3.0Cu0.5) solder (then let sit for 48±4 hours for X7R X5R and Y5V).</p> <p>Then apply a force in the direction shown in Fig.b. The soldering shall be done with the reflow method and shall be conducted with care so that the soldering is uniform and free of defects such as heat shock.</p> <table border="1"> <thead> <tr> <th>Size</th> <th>a</th> <th>b</th> <th>C</th> </tr> </thead> <tbody> <tr> <td>0603</td> <td>0.3</td> <td>0.9</td> <td>0.3</td> </tr> <tr> <td>1005</td> <td>0.4</td> <td>1.5</td> <td>0.5</td> </tr> <tr> <td>1608</td> <td>1.0</td> <td>3.0</td> <td>1.2</td> </tr> <tr> <td>2012</td> <td>1.2</td> <td>4.0</td> <td>1.65</td> </tr> <tr> <td>3216</td> <td>2.2</td> <td>5.0</td> <td>2.0</td> </tr> <tr> <td>4520</td> <td>3.5</td> <td>7.0</td> <td>2.5</td> </tr> <tr> <td>4532</td> <td>3.5</td> <td>7.0</td> <td>3.7</td> </tr> </tbody> </table>	Size	a	b	C	0603	0.3	0.9	0.3	1005	0.4	1.5	0.5	1608	1.0	3.0	1.2	2012	1.2	4.0	1.65	3216	2.2	5.0	2.0	4520	3.5	7.0	2.5	4532	3.5	7.0	3.7									
Size	a	b	C																																									
0603	0.3	0.9	0.3																																									
1005	0.4	1.5	0.5																																									
1608	1.0	3.0	1.2																																									
2012	1.2	4.0	1.65																																									
3216	2.2	5.0	2.0																																									
4520	3.5	7.0	2.5																																									
4532	3.5	7.0	3.7																																									
12 Solderability of Termination	90% of the terminations are to be soldered evenly and continuously.		Immerse the test capacitor into a methanol solution containing rosin for 3 to 5 seconds, preheat it 150 to 180°C for 2 to 3 minutes and immerse it into SAC305(Sn96.5Ag3.0Cu0.5) solder of 245 ± 5°C for 3±1seconds.																																									

	Item	Specification		Test Method		
		Temp. compensating type	High dielectric constant type			
13	Resistance to Soldering Heat	Appearance	No marking defects		*Preheat the capacitor at 120 to 150°C for 1 minute. Immerse the capacitor in a SAC305(Sn96.5Ag3.0Cu0.5) solder solution at 270±5°C for 10±1 seconds. Let sit at room temperature for 24±2 hours (temperature compensating type) or 48±4 hours (high dielectric constant type), then measure. * Preheat 150 to 200°C for size ≥3216. *High dielectric constant type: Initial measurement : perform a heat treatment at 150+/-10°C for one hour and then let sit for 48±4 hours at room temperature. Perform the initial measurement.	
		Cap. Change	NP0 within ±2.5% or 0.25pF (whichever is larger)	X7R/X5R within ±7.5% Y5V within ±20%		
		Q/D.F.	If C ≤30pF, DF ≤1/(400+20C) If C >30pF, DF ≤0.1%	To satisfy the specified initial spec.		
		I.R.	I.R. ≥ 10,000MΩ or R _i C _r ≥ 500Ω-F. (whichever is smaller)	I.R. ≥ 10,000MΩ or R _i C _r ≥ 500Ω-F. (whichever is smaller)		
14	Temperature cycle (Thermal shock)	Appearance	No marking defects		Solder the capacitor to supporting jig (glass epoxy board) and perform the five cycles according to the four heat treatments listed in the following table. Let sit for 24±2hrs at room temperature, then measure. Step 1: Minimum operating temperature 30±3min Step 2: Room temperature 2~3 min Step 3: Maximum operating temperature 30±3min Step 4: Room temperature 2~3min *High dielectric constant type: Initial measurement: perform a heat treatment at 150+/-10°C for one hour and then let sit for 48±4 hours at room temp. Perform the initial measurement.	
		Cap. Change	NP0 within ±2.5% or 0.25pF (whichever is larger)	X7R/X5R within ±7.5% Y5V within ±20%		
		Q/D.F.	If C ≤30pF, DF ≤1/(400+20C) If C >30pF, DF ≤0.1%	To satisfy the specified initial spec.		
		I.R.	I.R. ≥ 10,000MΩ or R _i C _r ≥ 500Ω-F. (whichever is smaller)	I.R. ≥ 10,000MΩ or R _i C _r ≥ 500Ω-F. (whichever is smaller)		
15	Humidity load	Appearance	No marking defects		Apply the rated voltage at 40±2°C and 90 to 95% humidity for 500±12 hours. Remove and let sit for 24±2 hours (temperature compensating type) or 48±4 hours (high dielectric constant type) at room temperature, then measure. The charge / discharge current is less than 50mA. *High dielectric constant type: Initial measurement: perform a heat treatment at 150+/-10°C for one hour and then let sit for 48±4hours at room temperature. Perform the initial measurement.	
		Cap. Change	NP0 within ±7.5% or 0.75pF (whichever is larger)	X7R/X5R within ±12.5% Y5V within ±30%		
		Q/D.F.	If C >30pF, DF ≤0.5% If C ≤30pF, DF ≤1/(100+10xC/3) C in pF	X7R 200% max of initial spec. Y5V 150% max of initial spec. X5R 200% max of initial spec.		
		I.R.	I.R. ≥ 500MΩ or R _i C _r ≥ 25Ω-F. (whichever is smaller)	I.R. ≥ 500MΩ or R _i C _r ≥ 25Ω-F. (whichever is smaller) * some of the parts are RiCr ≥ 12.5Ω-F, please refer to table 2		
16	High temperature load life test	Appearance	No marking defects		Apply 200%(150% for ≥500V; 120% for ≥1000V) of the rated voltage for 1000±12 hours at the maximum operating temperature ±3°C. Let sit for 24±2 hours (temperature compensating type) or 48±4 hours (high dielectric constant type) at room temperature, then measure. The charge/discharge current is less than 50mA. *High dielectric constant type: Initial measurement: perform a heat treatment at 150+/-10°C for one hour and then let sit for 48±4hours at room temperature. Perform the initial measurement. P.S.: Please refer to table 1 for items applying 150% voltage. * 150% for high dielectric constant type ≥500V. * 120% for voltage ≥ 1000V. * some of the parts are applicable in rated voltage *1.5. please refer to table 2	
		Cap. Change	NP0 within ±7.5% or 0.75pF (whichever is larger)	X7R/X5R within ±12.5% Y5V within ±30%		
		Q/D.F.	If C >30pF, DF ≤0.3% If 10pF < C ≤ 30pF, DF ≤ 1/(275+5xC/2) If C ≤ 10pF, DF ≤ 1/(200+10C), C in pF	X7R 200% max of initial value Y5V 150% max of initial value X5R 200% max of initial value		
		I.R.	More than 1GΩ or R _i C _r ≥ 50Ω-F (whichever is less.)	More than 1GΩ or R _i C _r ≥ 50Ω-F (whichever is less.) * some of the parts are RiCr ≥ 25Ω-F, please refer to table 2		

Table 2

TC	Product Range
X5R	0603 (EIA 0201): C > 10 nF
	1005 (EIA 0402): C > 0.1 uF
	1608 (EIA 0603): C ≥ 1.0 uF
	2012 (EIA 0805): C ≥ 2.2 uF
	3216 (EIA 1206): C ≥ 10 uF
	3225 (EIA 1210): C ≥ 22 uF
Y5V	1005 (EIA 0402): C > 0.47 uF
	1608 (EIA 0603): C > 1.0 uF
	2012 (EIA 0805): C > 4.7 uF
	3216 (EIA 1206): C > 10 uF
	3225 (EIA 1210): C > 22 uF

■ X5R/X7R DF (tan δ) Table

Rated Voltage	Size	Capacitance	D.F Max.	
			X5R	X7R
4V	All	All	15.0%	
6.3V	All	cap ≤1.0uF	10.0%	7.5%
	All	1.0uF < cap < 4.7uF	10.0%	10.0%
	All	4.7uF ≤ cap ≤ 100uF	15.0%	15.0%
10V	0603/3216/3225	All	7.5%	5.0%
	0603	100nF ≤ cap	10.0%	
		cap ≤ 100nF	7.5%	5.0%
	1005	100nF < cap < 330nF	7.5%	
		330nF ≤ cap	10.0%	
		cap ≤ 1.0uF	7.5%	5.0%
	1608	1.0uF < cap < 2.2uF	7.5%	
		2.2uF ≤ cap	10.0%	
		cap < 2.2uF	7.5%	5.0%
	2012	2.2uF ≤ cap	10.0%	
3216	10uF	10.0%	10.0%	
3225	10uF < cap ≤ 22uF	10.0%	10.0%	
16V	0603/3216/3225	All	5.0%	5.0%
	1005	cap ≤ 100nF	5.0%	5.0%
		100nF < cap ≤ 220nF	7.5%	
	1608	cap ≤ 470nF	5.0%	5.0%
		470nF < cap < 1.0uF	7.5%	5.0%
		1.0uF ≤ cap	10.0%	10.0%
	2012	cap ≤ 2.2uF	5.0%	5.0%
		2.2uF < cap ≤ 4.7uF	7.5%	
		4.7uF < cap ≤ 10uF	10.0%	
	3216	4.7uF < cap	10.0%	10.0%
3225	10uF < cap ≤ 22uF	15.0%		
25V	All	All	5.0%	3.5%
	1608	1.0uF ≤ cap	10.0%	
		470nF		10.0%
	3216	1.0uF < cap ≤ 4.7u	5.0%	5.0%
		4.7uF < cap	10.0%	
3225	4.7uF < cap ≤ 10u	10.0%		
≥ 50V	All	All but below	2.5%	3.0%
	3216/3225	cap ≤ 1.0uF	3.5%	3.5%

■ Y5V DF (tan δ) Table

T.C	Rated Voltage	Size	Capacitance	D.F Max
Y5V	4V	0603	ALL	16.0%
		1005	ALL	20.0%
	6.3V	0603	ALL	16.0%
			cap ≤ 220nF	12.5%
		1005	220nF < cap	16.0%
			ALL	12.5%
	1608	ALL	16.0%	
		2012	ALL	16.0%
	10V	1005/1608	ALL	12.5%
			1005	220nF < cap
		2012	cap < 10uF	12.5%
			10uF	20.0%
	16V	1005	cap ≤ 220nF	9.0%
			220nF < cap	12.5%
			cap ≤ 100nF	7.0%
			100nF < cap ≤ 220nF	9.0%
		1608	220nF < cap	12.5%
			cap < 2.2uF	9.0%
			2.2uF ≤ cap	12.5%
			cap ≤ 100nF	9.0%
	25V/50V	1005	cap < 100nF	5.0%
			100nF	7.0%
			100nF < cap	9.0%
			cap < 330nF	5.0%
1608		330nF	7.0%	
		330nF < cap	9.0%	
		cap < 330nF	5.0%	
		330nF < cap	9.0%	

NP0 High Frequency Type (Q Series)

Item	Specification	Test Method																
1	Operating Temperature Range NP0: -55 to 125 degree C	---																
2	Rated Voltage 16VDC, 25VDC, and 50VDC	The rated voltage is defined as the maximum voltage, which may be applied continuously to the capacitor.																
3	Appearance No defects or abnormalities.	Visual inspection																
4	Dimensions Within the specified dimension.	Using calipers																
5	Dielectric Strength (Flash) No defects or abnormalities.	No failure shall be observed when 250% of the rated voltage is applied between the terminations for 1 to 5 seconds. The charge and discharge current is less than 50mA.																
6	Insulation Resistance (I.R.) I.R. $\geq 10G\Omega$	The insulation resistance shall be measured with a DC voltage not exceeding the rated voltage at 25°C and 75%RH max, and within 1 minute of charging.																
7	Capacitance Within the specified tolerance	The capacitance / D.F. shall be measured at 25°C at the frequency and voltage shown in the tables.																
8	Quality Factor (Q) 30pF min.: $Q \geq 1000$ 30pF max.: $Q \geq 400+20C$ C: Nominal Capacitance (pF)	<table border="1"> <tr> <td>Frequency</td> <td>1.0±0.2MHz</td> </tr> <tr> <td>Voltage</td> <td>1.0±0.2Vrms</td> </tr> </table>	Frequency	1.0±0.2MHz	Voltage	1.0±0.2Vrms												
Frequency	1.0±0.2MHz																	
Voltage	1.0±0.2Vrms																	
9	Capacitance Temperature Characteristics Capacitance change within 0±30ppm/°C under operating temperature range.	The capacitance value at 25°C and 85°C shall be measured and calculated from the formula given below. $T.C. = (C_{85} - C_{25}) / C_{25} * \Delta T * 10^6 (PPM/°C)$																
10	Termination Strength No removal of the terminations or marking defect.	Apply a parallel force of 5N to a PCB mounted sample for 10±1sec. *2N for 0603 (EIA 0201).																
11	Deflection (Bending Strength) Appearance: No cracking or marking defects shall occur at 1mm deflection. Capacitance change: within ±2.5% or ± 0.25pF. (whichever is larger)	Solder the capacitor to the test jig (glass epoxy boards) shown in Fig.a. Using a SAC305(Sn96.5Ag3.0Cu0.5) solder. Then apply a force in the direction shown in Fig.b. The soldering shall be done with the reflow method and shall be conducted with care so that the soldering is uniform and free of defects such as heat shock.																
<table border="1"> <thead> <tr> <th>Size</th> <th>a</th> <th>b</th> <th>C</th> </tr> </thead> <tbody> <tr> <td>0603</td> <td>0.3</td> <td>0.9</td> <td>0.3</td> </tr> <tr> <td>1005</td> <td>0.4</td> <td>1.5</td> <td>0.5</td> </tr> <tr> <td>1608</td> <td>1.0</td> <td>3.0</td> <td>1.2</td> </tr> </tbody> </table>			Size	a	b	C	0603	0.3	0.9	0.3	1005	0.4	1.5	0.5	1608	1.0	3.0	1.2
Size	a	b	C															
0603	0.3	0.9	0.3															
1005	0.4	1.5	0.5															
1608	1.0	3.0	1.2															
12	Solderability of Termination	90% of the terminations are to be soldered evenly and continuously.																
13	Resistance to Soldering Heat	Appearance No marking defects	Immerse the capacitor into a methanol solution containing rosin for 3 to 5 seconds, preheat it 150 to 180°C for 2 to 3 minutes and immerse it into SAC305(Sn96.5Ag3.0Cu0.5) solder of 245 ± 5°C for 3±1seconds.															
		Cap. Change NP0 within ±2.5% or ±0.25pF (whichever is larger)																
		Q Initial spec.																
		I.R. Initial spec.																
14	Temperature cycle (Thermal shock)	Appearance No marking defects	Solder the capacitor to supporting jig (glass epoxy board) and perform the five cycles according to the four heat treatments listed in the following table. Let sit for 24±2hrs at room temperature, then measure. Step 1: Minimum operating temperature 30±3min Step 2: Room temperature 2~3 min Step 3: Maximum operating temperature 30±3min Step 4: Room temperature 2~3min															
		Cap. Change NP0 within ±2.5% or 0.25pF (whichever is larger)																
		Q Initial spec.																
		I.R. Initial spec.																
15	Humidity load	Appearance No marking defects	Apply the rated voltage at 40±2°C and 90 to 95% humidity for 500±12 hours. Remove and let sit for 24±2 hours at room temperature, then measure. The charge / discharge current is less than 50mA.															
		Cap. Change NP0 within ±5% or ±0.5pF (whichever is larger)																
		Q 200 min.																
		I.R. I.R. $\geq 500M\Omega$																
16	High temperature load life test	Appearance No marking defects	Apply 200% of the rated voltage for 1000±12 hours at the maximum operating temperature ± 3°C. Let sit for 24± 2 hours at room temperature, then measure. The charge/discharge current is less than 50mA.															
		Cap. Change NP0 within ±5% or ±0.5pF (whichever is larger)																
		Q 350 min.																
		I.R. I.R. $\geq 1G\Omega$																
17	RF Characteristics	Q See RF Characteristics of NP0 Q series P:19~21	Measurements performed on a HP4287A with fixture 16196 and represent the typical capacitor performance.															
		ESR																

TEMPERATURE COEFFICIENT

- Class 1 (Temperature Compensation series)

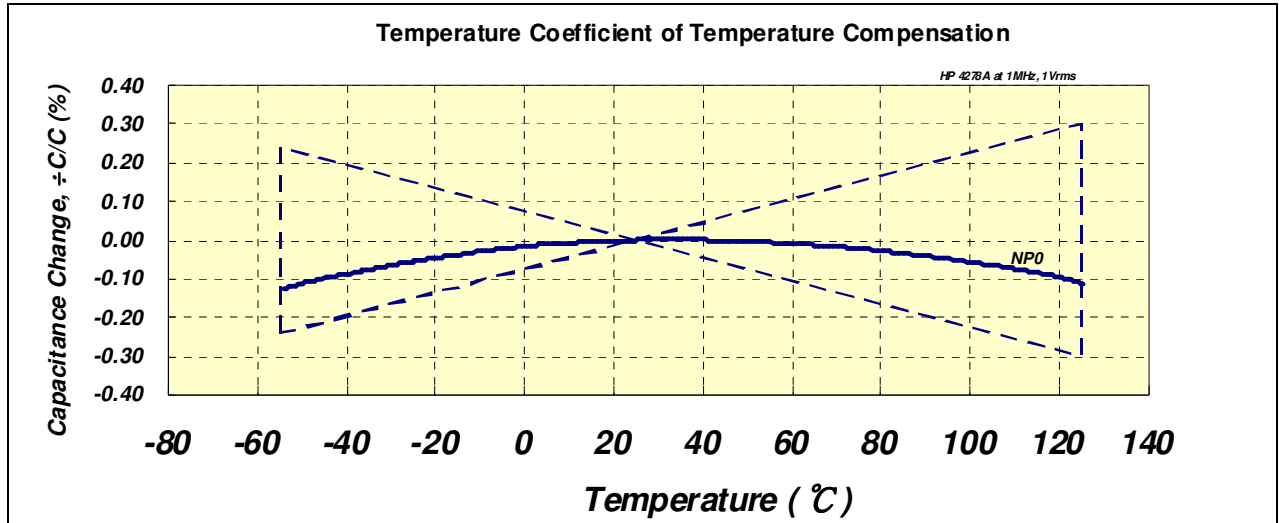

- Class 2 (High Dielectric Constant Series)

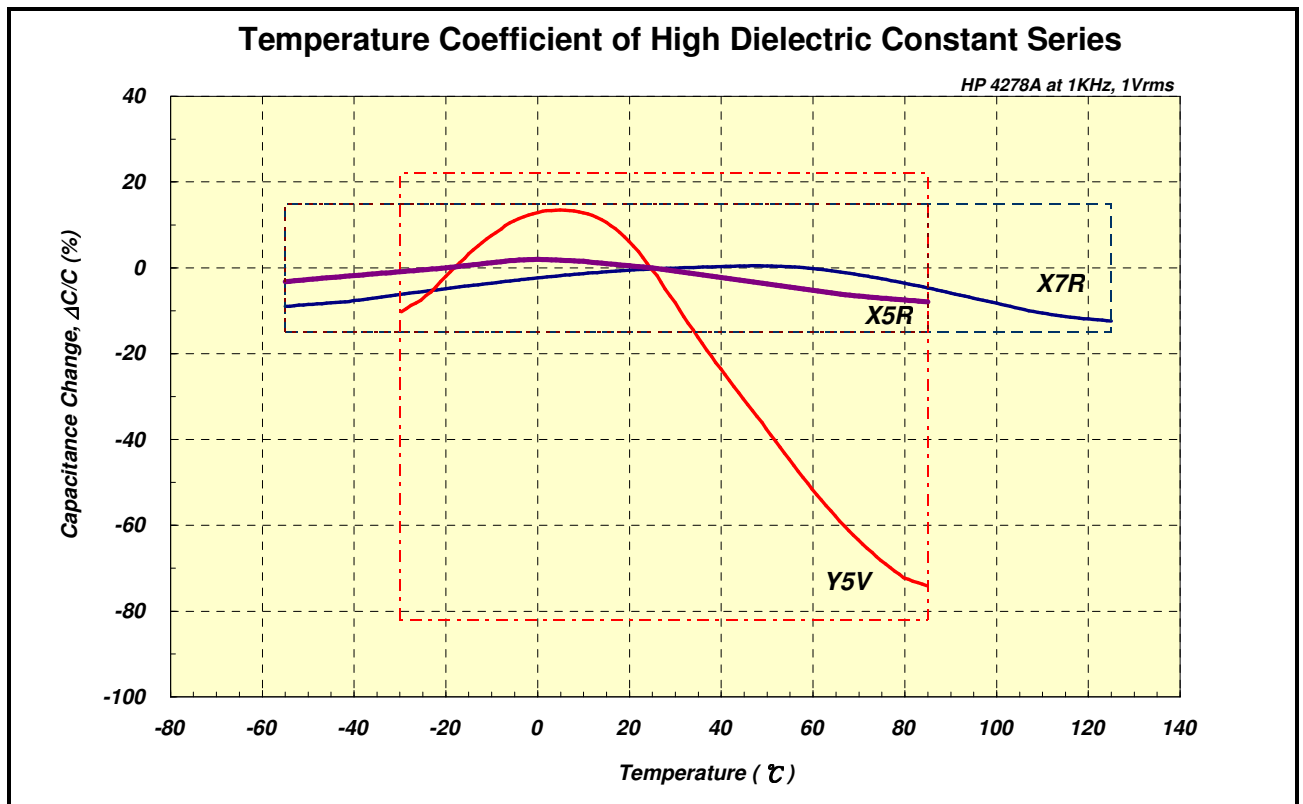

DC VOLTAGE COEFFICIENT

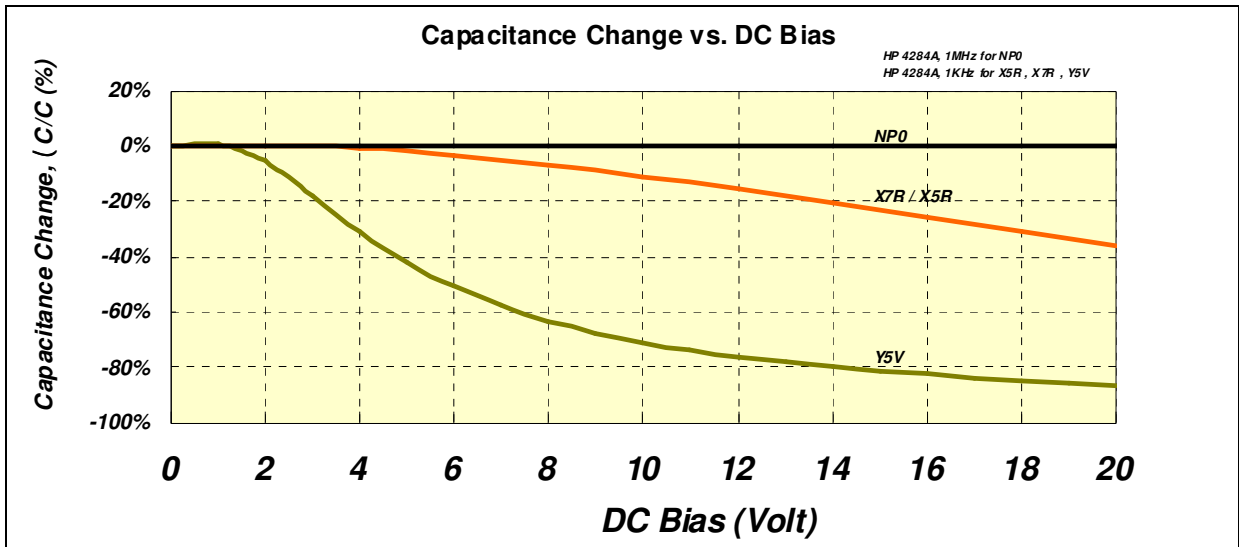

AGING RATE

The capacitance and dissipation factor of class 2 capacitors decreases with time. It is known as 'aging' that follows a logarithmic law and expressed in terms of an aging constant. Aging is caused by a gradual re-alignment of the crystalline structure of the ceramic. The aging constant is defined as the percentage loss of capacitance at a 'time decade'. The law of capacitance aging is expressed as following equation:

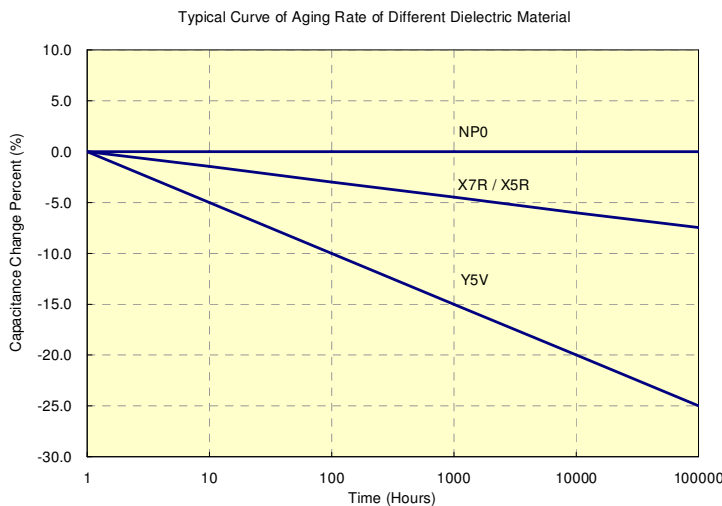

$$C_{t_2} = C_{t_1} \times (1 - k \times \log_{10}(t_2/t_1))$$

C_{t_1} : Capacitance after t_1 hours of start aging.

C_{t_2} : Capacitance after t_2 hours of start aging.

k : aging constant (capacitance decrease per decade)

t_1, t_2 : time in hours from start of aging.

A typical curve of aging rate is shown in following figure.

When heating the capacitors above Curie temperature ($130^{\circ}\text{C} \sim 150^{\circ}\text{C}$) the capacitance can be re-new. So capacitance of class 2 capacitors will be complete de-aged by soldering process; subsequently a new aging process begins.

Because of aging, it is specified an age for measurement to meet the prescribed tolerance for class 2 capacitors. Normally, 1000 hours ($t_2=1000$ hrs) is defined.

- Typical RF Characteristics for High Frequency NPO (C0G) 0603 (EIA 0201) at 1GHz.

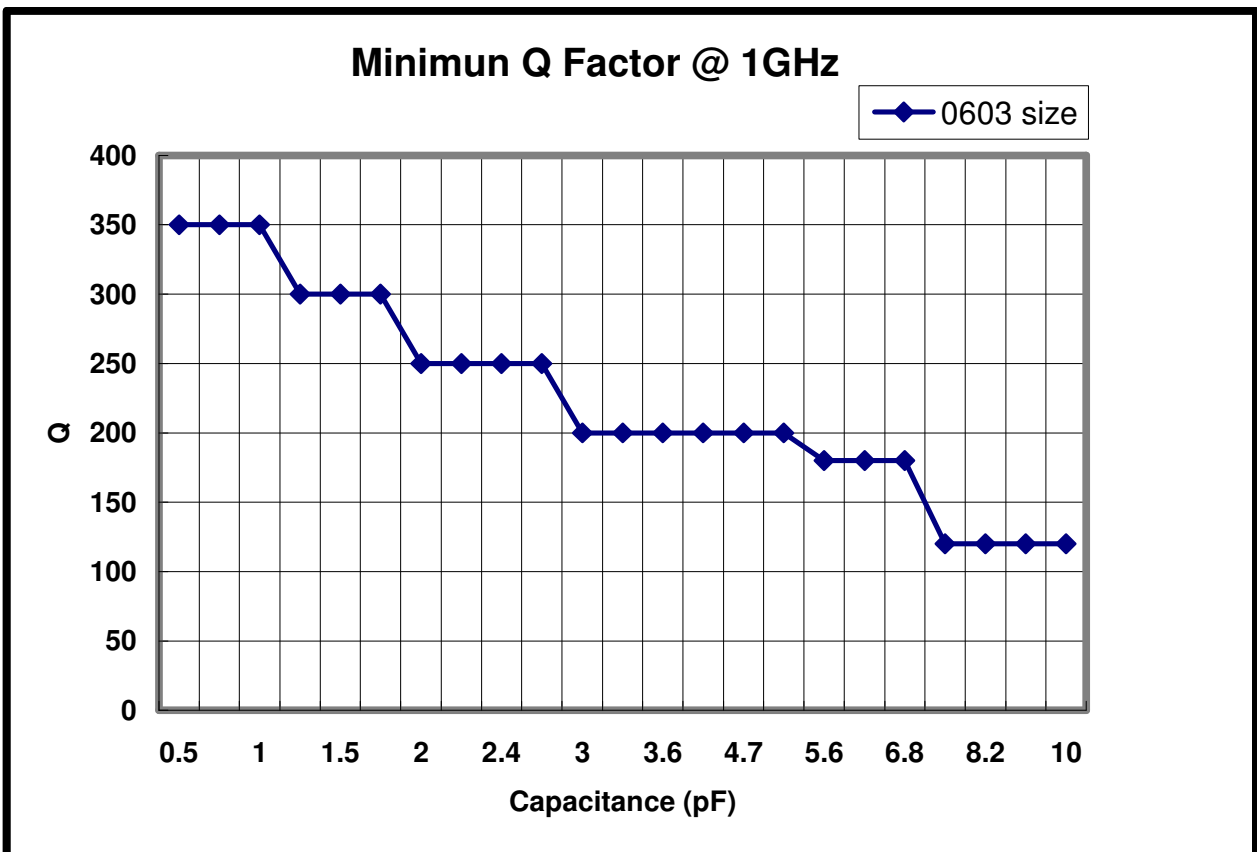
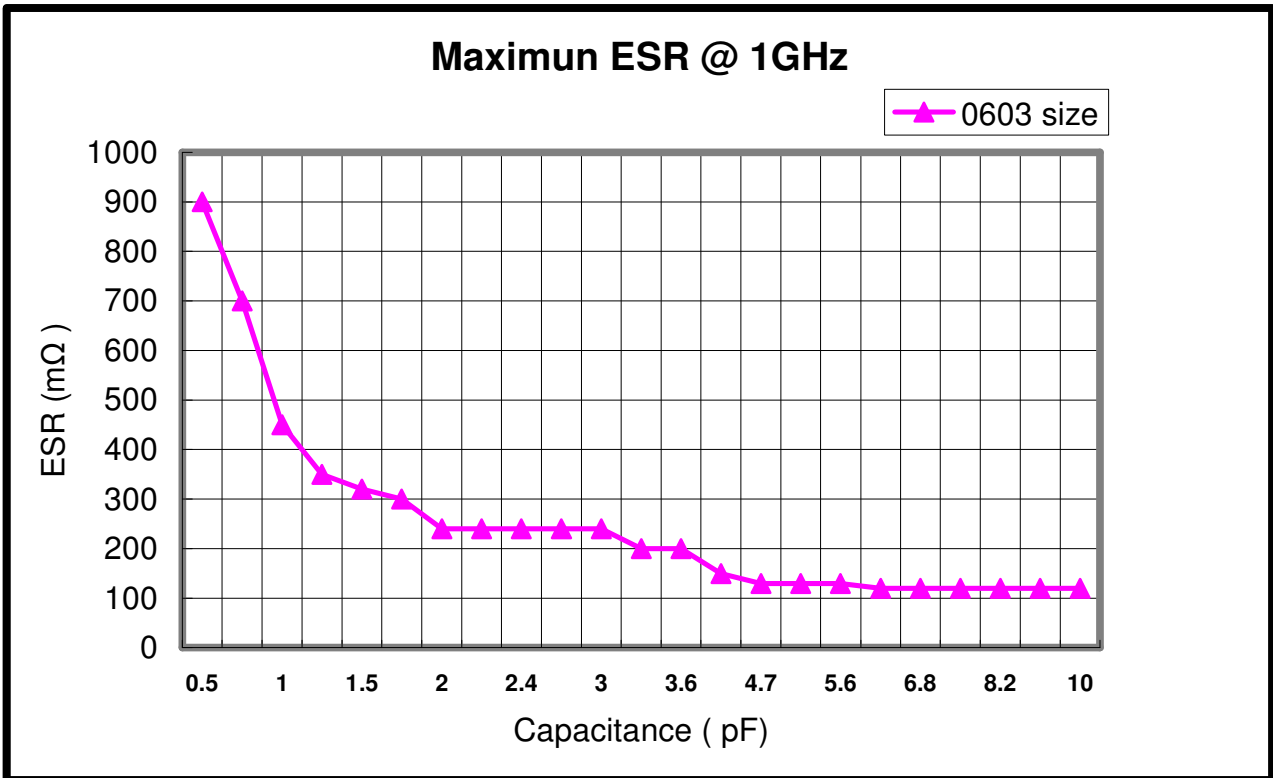

Measurements performed on a HP4287A with fixture 16196C and represent the typical capacitor performance.

■ Typical RF Characteristics for High Frequency NP0 (C0G) 1005 (EIA 0402) at 1GHz.

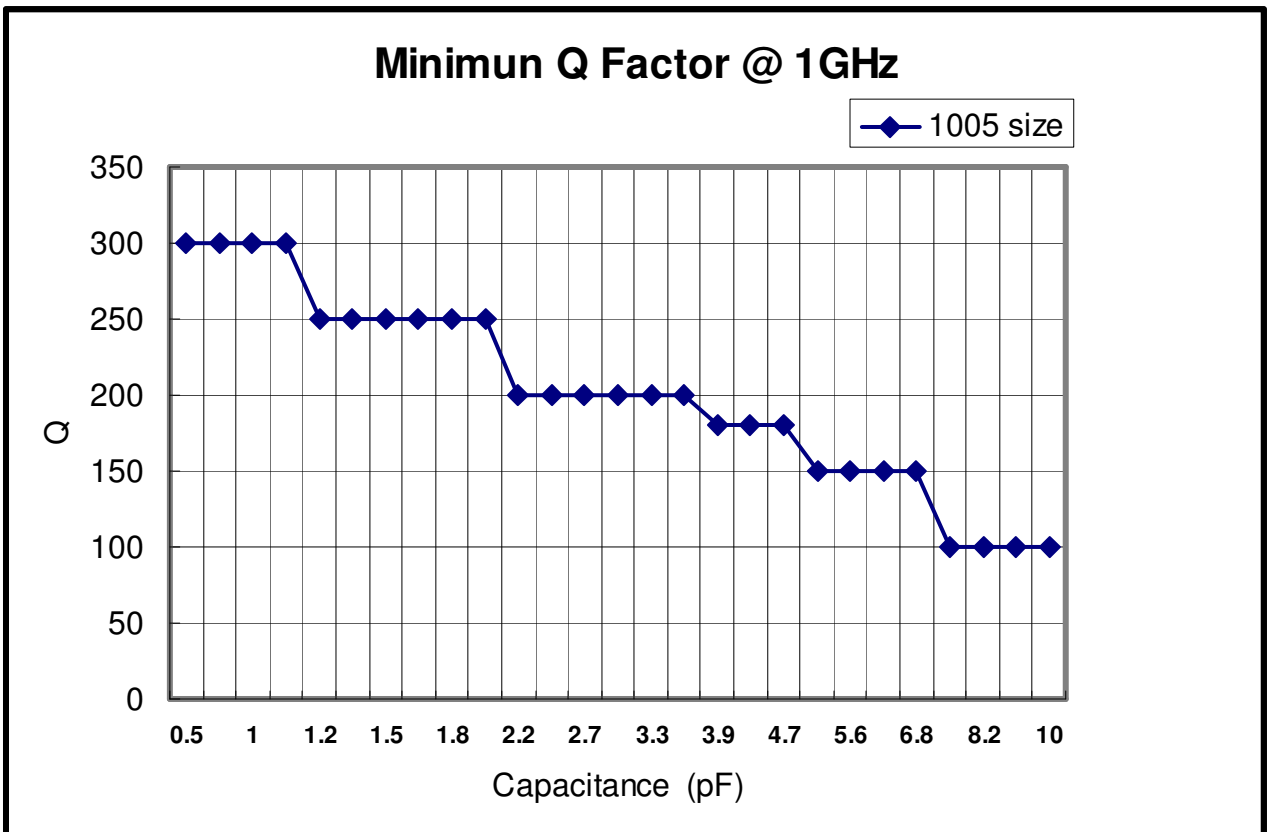
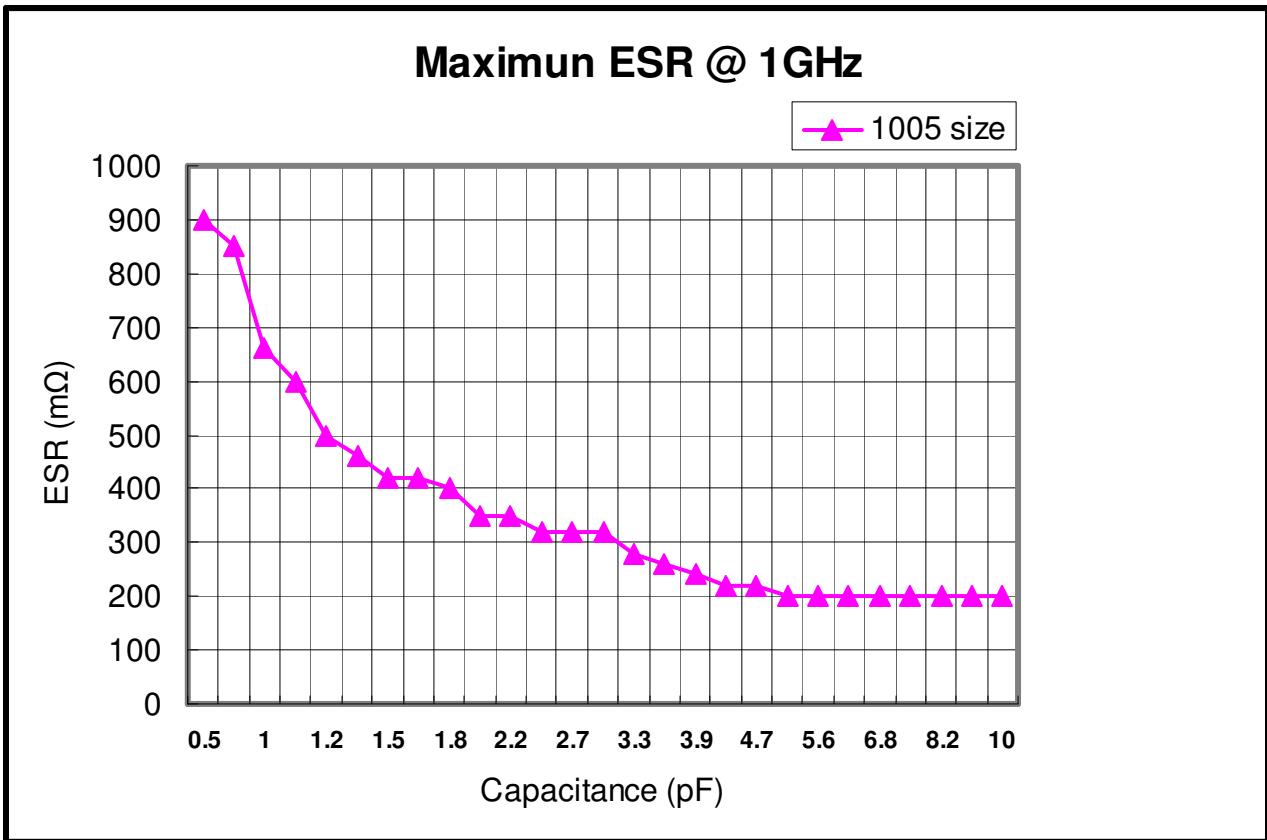

Measurements performed on a HP4287A with fixture 16196B and represent the typical capacitor performance.

- Typical RF Characteristics for High Frequency NP0 (COG) 1608 (EIA 0603) at 1GHz.

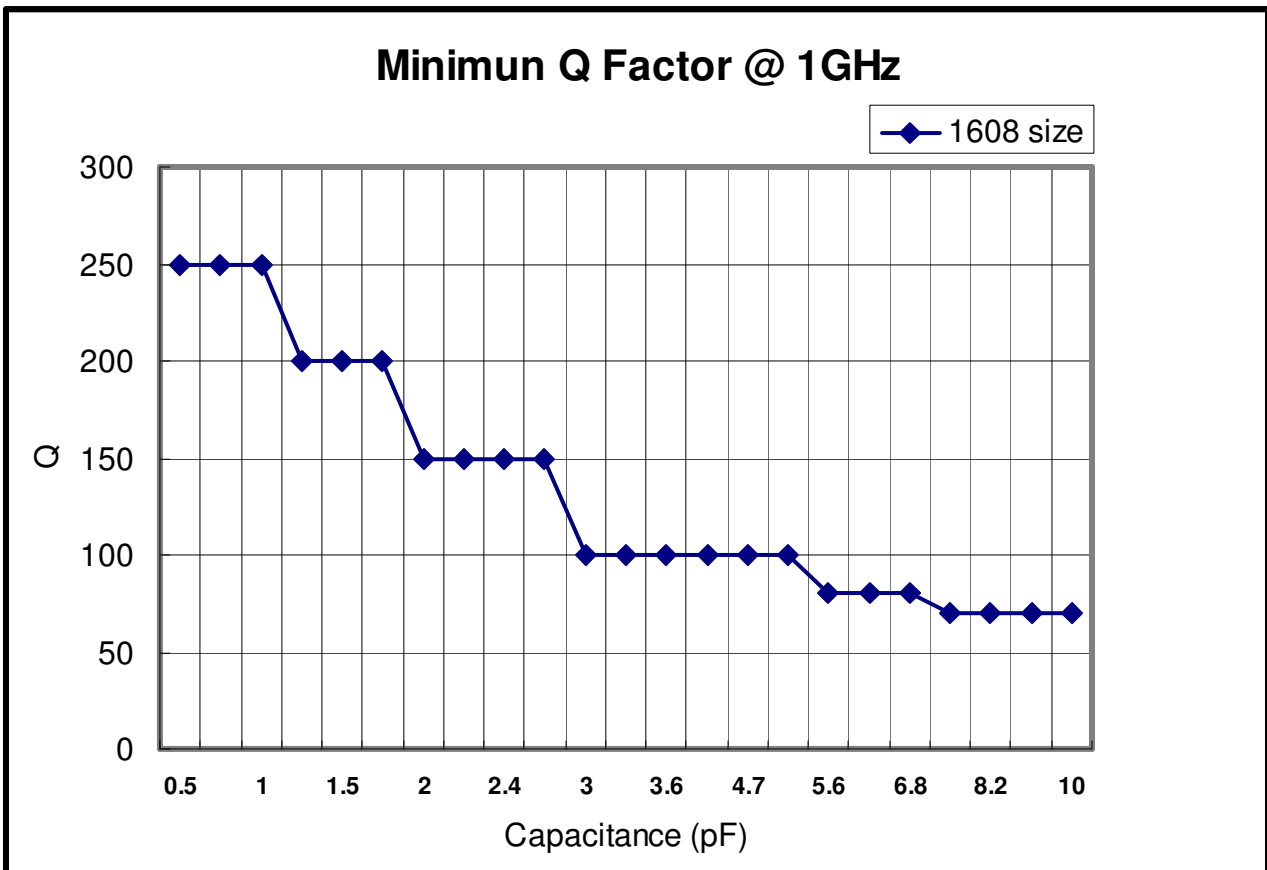
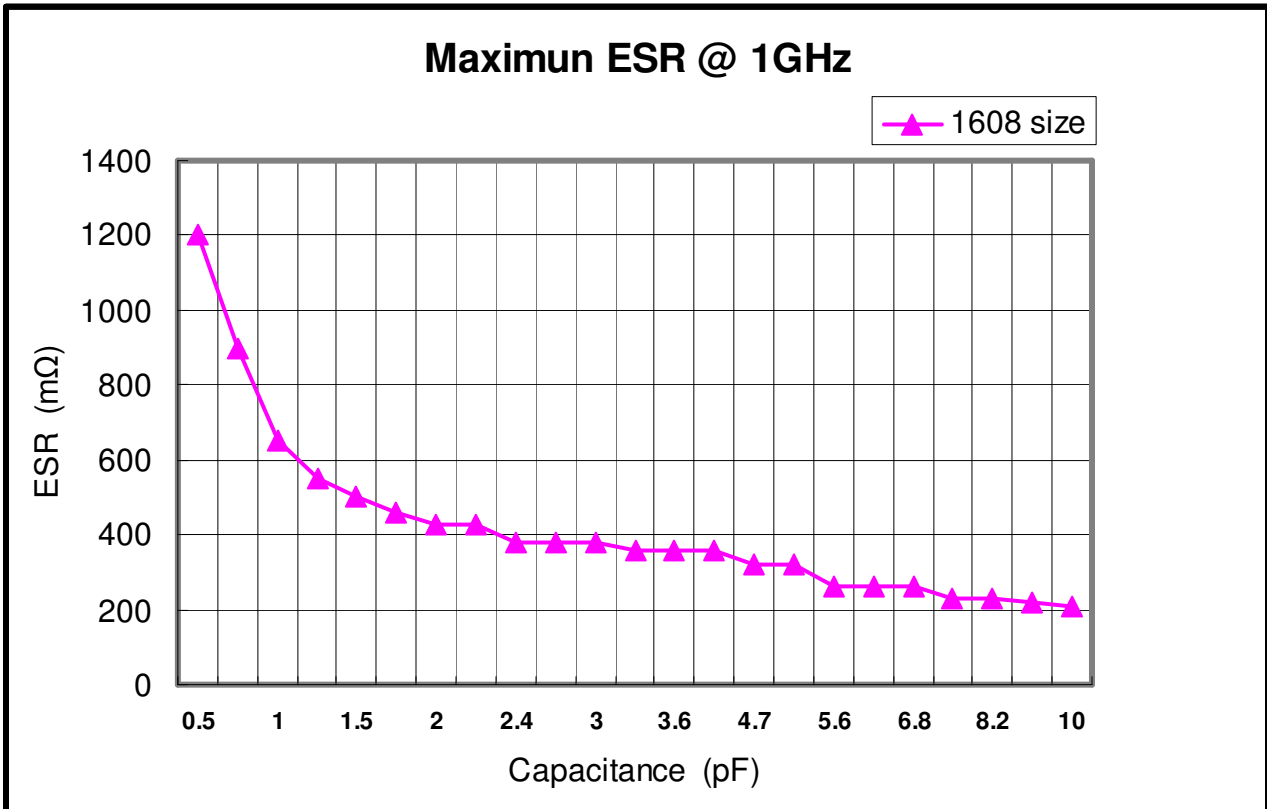

Measurements performed on a HP4287A with fixture 16196A and represent the typical capacitor performance.

■ Packing

● Tape and reel packaging

Tape and reel packaging is currently the most promising system for high-speed production. A typical 180mm (7 inch) diameter reel contains 1,500 to 15,000 capacitors, 250mm (10 inch) contains 10,000 capacitors, and 330mm(13 inch) contains 10,000 to 50,000 capacitors. Three standard sizes are available in taped and reeled package either with paper carrier tapes or embossed tapes.

● Paper tape specifications

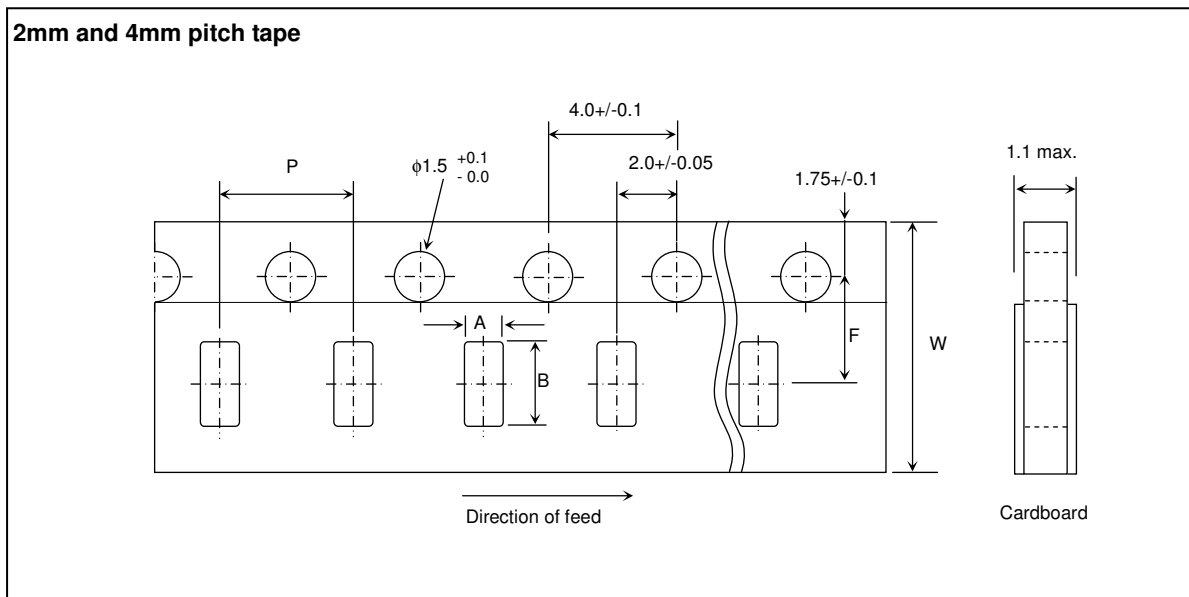

SYMBOL	PRODUCT SIZE CODE										UNIT
	0603(0201)		1005(0402)		1608(0603)		2012(0805)		3216(1206)		
	SIZE	TOL.	SIZE	TOL.	SIZE	TOL.	SIZE	TOL.	SIZE	TOL.	
A	0.38	+/- 0.04	0.60	+/- 0.04	1.0	+/- 0.2	1.5	+/- 0.2	1.9	+/- 0.2	mm
B	0.68	+/- 0.04	1.12	+/- 0.04	1.8	+/- 0.2	2.3	+/- 0.2	3.6	+/- 0.2	mm
F	3.50	+/- 0.05	3.50	+/- 0.05	3.5	+/- 0.05	3.5	+/- 0.05	3.5	+/- 0.05	mm
P	2.00	+/- 0.10	2.00	+/- 0.10	4.0	+/- 0.1	4.0	+/- 0.1	4.0	+/- 0.1	mm
W	8.00	+/- 0.20	8.00	+/- 0.20	8.0	+/- 0.2	8.0	+/- 0.2	8.0	+/- 0.2	mm

- Embossed tape specifications

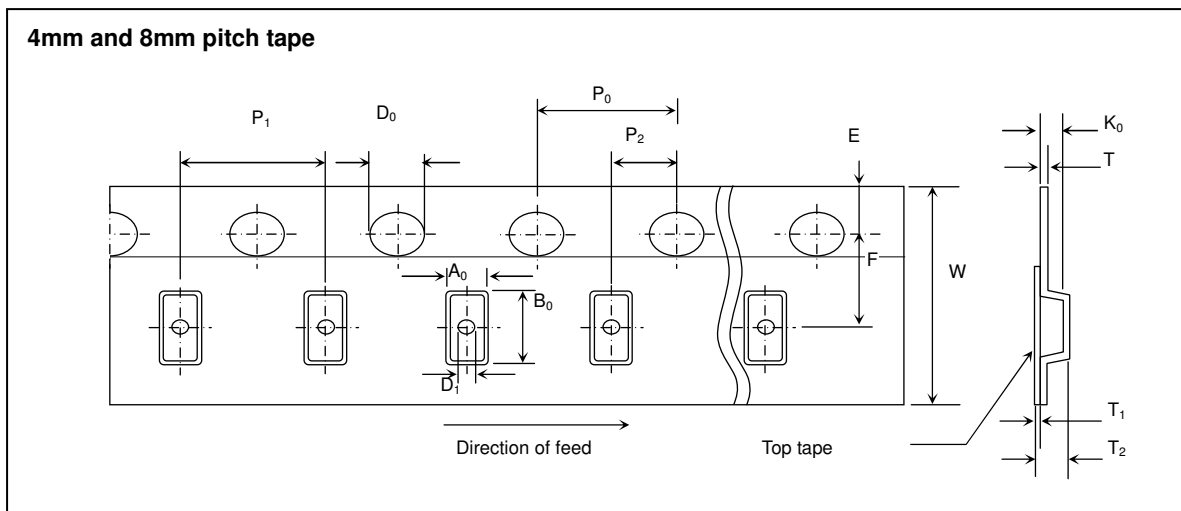

k_0 : so chosen that the orientation of the component cannot change.

For $W = 8\text{mm}$: $T_2 = 2.5\text{mm max.}$

For $W = 12\text{mm}$: $T_2 = 4.5\text{mm}$

DIMENSION (mm)	PRODUCT SIZE CODE					TOLERANCE (mm)
	4 mm tape			8 mm tape		
	2012 (0805)	3216 (1206)	3225 (1210)	4520 (1808)	4532 (1812)	
P_1	4	4	4	8	8	+/- 0.10
P_0	4	4	4	4	4	+/- 0.10
P_2	2	2	2	2	2	+/- 0.05
A_0 nominal clearance*	0.2	0.3	0.3	0.4	0.4	-
B_0 nominal clearance*	0.2	0.3	0.3	0.4	0.4	-
K_0 minimum clearance*	0.05	0.05	0.05	0.05	0.05	-
W	8.0	8.0	8.0	12.0	12.0	+/- 0.20
E	1.75	1.75	1.75	1.75	1.75	+/- 0.10
F	3.5	3.5	3.5	5.5	5.5	+/- 0.05
D_0	1.5	1.5	1.5	1.5	1.5	+0.1/-0.0
D_1	1 min	1 min	1 min	1.5 min	1.5 min	+0.1/-0.0
T	0.25	0.25	0.25	0.25	0.25	+/- 0.10
T_1	0.05	0.05	0.05	0.05	0.05	+/- 0.01
T_2	2.5 max.	2.5 max.	2.5 max.	4.5	4.5	-

* Typical capacitors displace in pocket.

- Reel specifications

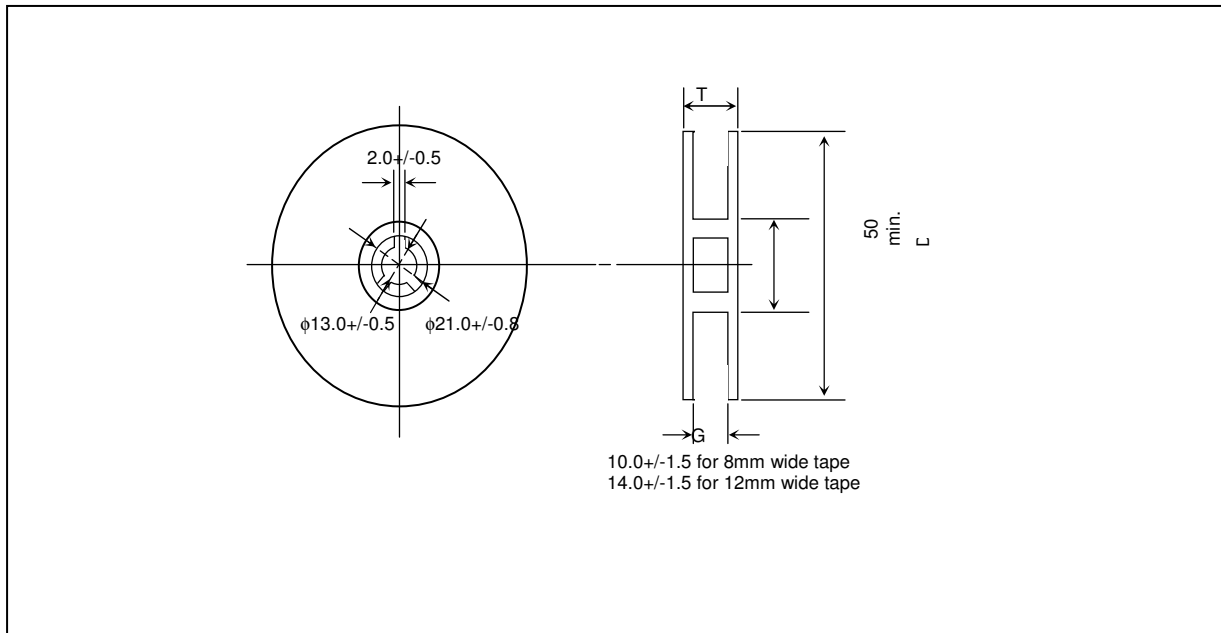

TAPE WIDTH (mm)	G (mm)	T max. (mm)	D (mm)
8	10.0 +/- 1.5	14.5	180
8	10.0 +/- 1.5	14.5	250
8	10.0 +/- 1.5	14.5	330
12	14.0 +/- 1.5	18.5	180

■ Thickness and Packing Amount

Thickness			Amount per reel					
			180 mm (7")		250 mm (10")		330 mm (13")	
Code	Spec	Size(EIA)	Paper	Embossed	Paper	Embossed	Paper	Embossed
A	0.30+/-0.03	0603 (0201)	15K					
B	0.50+/-0.05	1005 (0402)	10K				50K	
<u>B</u>	0.50+/-0.15	1005 (0402)	10K				50K	
Q	0.45+/-0.05	1005 (0402)	10K				50K	
C	0.60+/-0.15	2012 (0805)	4K		10K		15K	
		3216(1206)	4K		10K		15K	
Q	0.45+/-0.05	1608(0603)	4K		10K		15K	
D	0.80+/-0.10	1608(0603)	4K		10K		15K	
<u>D</u>	0.80+0.15/ -0.10	1608 (0603)	4K		10K		15K	
E	0.85+/-0.15	2012 (0805)	4K		10K		15K	
		3216 (1206)	4K		10K		15K	
		3225 (1210)		3K				10K
		4532 (1812)		1K				
I	0.95+/-0.15	2012(0805)		3K				
		3216(1206)		3K				
F	1.15+/-0.20	3216 (1206)		3K				10K
		4520 (1808)		3K				
G	1.25 +/-0.20	2012 (0805)		2K/3K				10K
		3216 (1206)		3K				10K
		3225 (1210)		3K				
		4520(1808)		3K				
		4532(1812)		1K				
<u>G</u>	1.25+0.3/-0.2	2012(0805)		2K/3K				10K
		3216(1206)		3K				10K
		3225(1210)		3K				
L	1.60+/-0.20	3216(1206)		2K				
		3225(1210)		2K				
		4520(1808)		2K				
		4532(1812)		1K				
<u>L</u>	1.60+0.30/-0.20	3216(1206)		2K				
		3225(1210)		2K				
		4520(1808)		2K				
		4532(1812)		1K				
N	2.00+/-0.20	3216 (1206)		2K/3K				
		3225 (1210)		2K				
		4520 (1808)		1K				
		4532(1812)		1K				
<u>N</u>	2.00+/-0.30	3225 (1210)		2K				
P	2.50+/-0.20	3225(1210)		500pcs/1K				
<u>P</u>	2.50+/-0.30	3225(1210)		500pcs/1K				

Storage

1. The chip capacitors shall be packaged in carrier tapes or bulk cases.
2. Keep storage place temperatures from +5°C to +35°C, humidity from 45 to 70% RH.
3. The storage atmosphere must be free of gas containing sulfur and chlorine. Also, avoid exposing the product to saline moisture. If the product is exposed to such atmospheres, the terminations will oxidize and solderability will be affected.
4. The solderability is assured for 12 months from our final inspection date if the above storage condition is followed.

Circuit Design

1. Once application and assembly environments have been checked, the capacitor may be used in conformance with the rating and performance, which are provided in both the catalog and the specifications. Exceeding the specifications listed may result in inferior performance. It may also cause a short, open, smoking, or flaming to occur, etc.
2. Please use the capacitors in conformance with the operating temperature provided in both the catalog and the specifications. Be especially cautious not to exceed the maximum temperature. In the situation the maximum temperature set forth in both the catalog and specifications is exceeded, the capacitor's insulation resistance may deteriorate, power may suddenly surge and short-circuit may occur. The loss of capacitance will occur, and may self-heat due to equivalent series resistance when alternating electric current is passed through. As this effect becomes critical in high frequency circuits, please exercise with caution. When using the capacitor in a (self-heating) circuit, please make sure the surface of the capacitor remains under the maximum temperature for usage. Also, please make certain temperature rise remain below 20°C.
3. Please keep voltage under the rated voltage, which is applied to the capacitor. Also, please make certain the peak voltage remains below the rated voltage when AC voltage is super-imposed to the DC voltage. In the situation where AC or pulse voltage is employed, ensure average peak voltage does not exceed the rated voltage. Exceeding the rated voltage provided in both catalog and specifications may lead to defective withstanding voltage or, in worse case situations, may cause the capacitor to burn out.
4. It's is a common phenomenon of high-dielectric products to have a deteriorated amount of static electricity due to the application of DC voltage.

Handling

Chip capacitors should be handled with care to avoid contamination or damage. The use of vacuum pick-up or plastic tweezers is recommended for manual placement. Tape and reeled packages are suitable for automatic pick and placement machine.

Flux

1. An excessive amount of flux or too rapid temperature rise can causes solvent burst, solder can generate a large quantity of gas. The gas can spreads small solder particles to cause solder balling effect or bridging problem.
2. Flux containing too high of a percentage of halide may cause corrosion of termination unless sufficient cleaning is applied.
3. Use rosin-type flux. Highly acidic flux (halide content less than 0.2wt%) is not recommended.
4. The water soluble flux causes deteriorated insulation resistance between outer terminations unless sufficiently cleaned.

Component Spacing

For wave soldering components, the spacing must be sufficient far apart to prevent bridging or shadowing. This is not so important for reflow process but enough space for rework should be considered. The suggested spacing for reflow soldering and wave soldering is 0.5mm and 1.0mm, respectively.

Solder Fillet

Too much solder amount may increase solder stress and cause crack risk. Insufficient solder amount may reduce adhesive strength and cause parts falling off PCB. When soldering, confirm that the solder is placed over 0.2mm of the surface of the terminations.

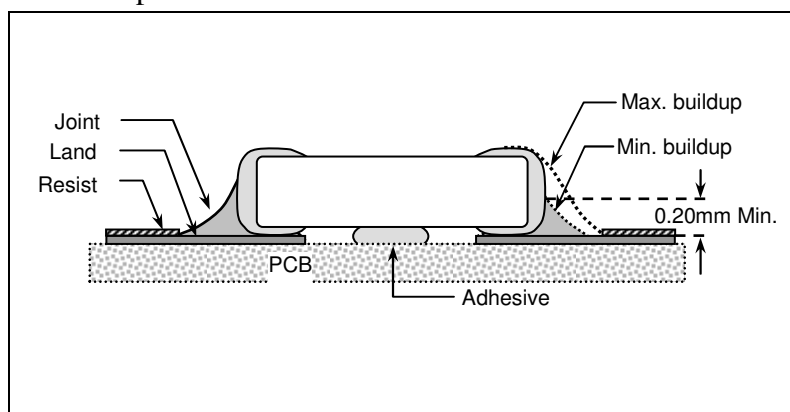

Recommended Land Pattern Dimensions

When mounting the capacitor to substrate, it's important to consider that the amount of solder (size of fillet) used has a direct effect upon the capacitor once it's mounted.

1. The greater the amount of solder, the greater the stress to the elements, as this may cause the substrate to break or crack.
2. In the situation where two or more devices are mounted onto a common land, separate the device into exclusive pads by using soldering resist.
3. Land width equal to or less than component. It is permissible to reduce land width to 80% of component width.

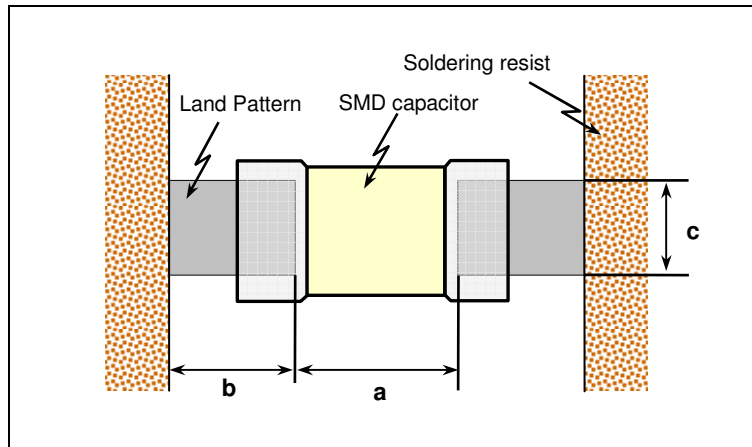

Size mm (EIA)	L x W (mm)	a (mm)	b (mm)	c (mm)
0603 (0201)	0.6*0.3	0.15 to 0.35	0.2 to 0.3	0.25 to 0.3
1005 (0402)	1.0*0.5	0.3 to 0.5	0.35 to 0.45	0.4 to 0.5
1608 (0603)	1.6*0.8	0.7 to 1.0	0.6 to 0.8	0.7 to 0.8
2012 (0805)	2.0*1.25	1.0 to 1.3	0.7 to 0.9	1.0 to 1.2
3216 (1206)	3.2*1.6	2.1 to 2.5	1.0 to 1.2	1.3 to 1.6
3225 (1210)	3.2*2.5	2.1 to 2.5	1.0 to 1.2	2.0 to 2.5
4520 (1808)	4.5*2.0	3.2 to 3.8	1.2 to 1.4	1.7 to 2.0
4532 (1812)	4.5*3.2	3.2 to 3.8	1.2 to 1.4	2.7 to 3.2

Resin Mold

If a large amount of resin is used for molding the chip, cracks may occur due to contraction stress during curing. To avoid such cracks, use a low shrinkage resin. The insulation resistance of the chip will degrade due to moisture absorption. Use a low moisture absorption resin. Check carefully that the resin does not generate a decomposition gas or reaction gas during the curing process or during normal storage. Such gases may crack the chip capacitor or damage the device itself.

Soldering Profile for SMT Process with SnPb Solder Paste

• Reflow Soldering

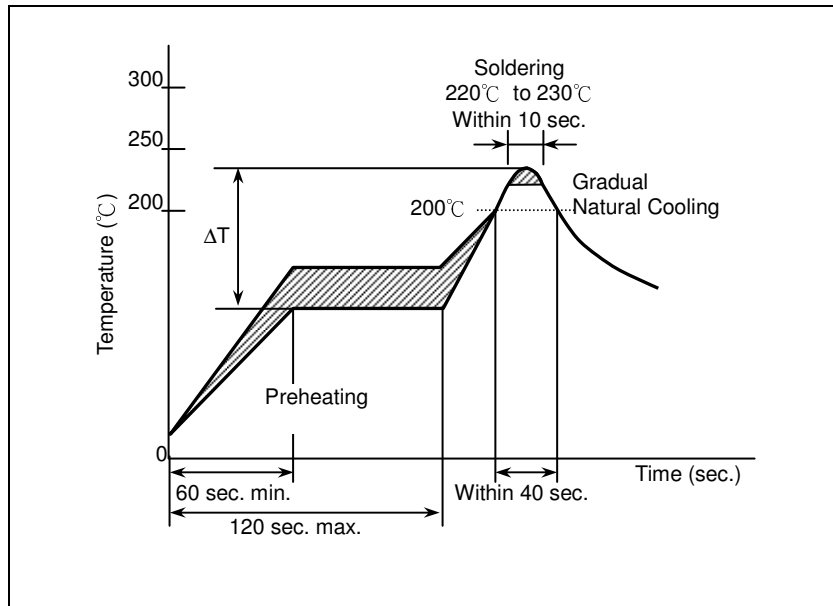

The difference between solder and chip surface should be controlled as following table. The rate of preheat should not exceed 4°C/sec and a target of 2°C/sec is preferred.

Chip Size	3216 and smaller	3225 and above
Preheating	$\Delta T \leq 150^\circ\text{C}$	$\Delta T \leq 130^\circ\text{C}$

- Wave Soldering

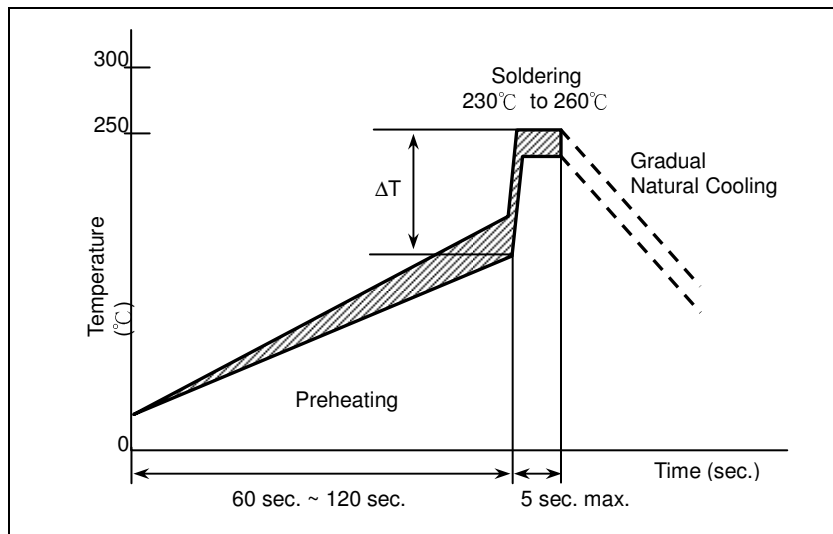

Chip Size	3216 and smaller	3225 and above
Preheating	$\Delta T \leq 150^\circ\text{C}$	-

- Soldering Iron

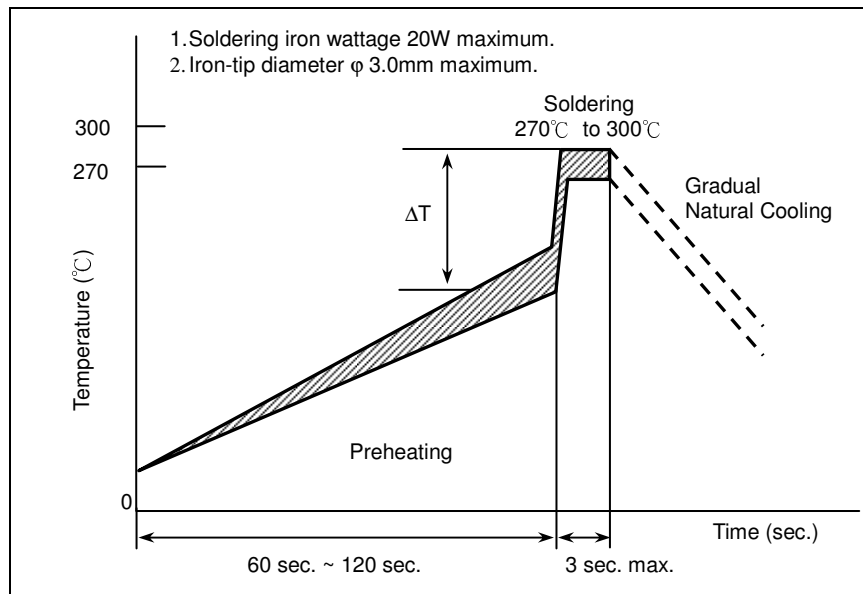

Chip Size	3216 and smaller	3225 and above
Preheating	$\Delta T \leq 190^\circ\text{C}$	$\Delta T \leq 130^\circ\text{C}$

Soldering

- Reflow Soldering for Lead free Termination

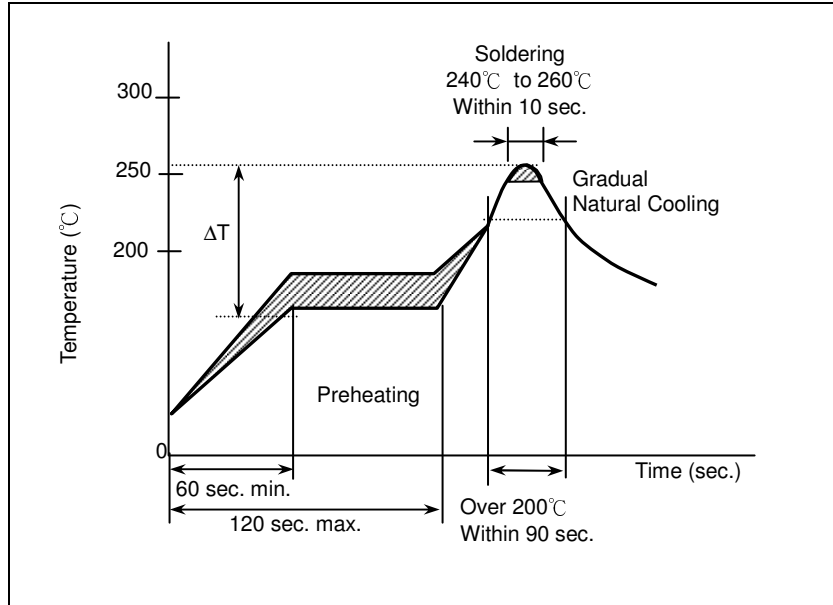

The difference between solder and chip surface should be controlled as following table. The rate of preheat should not exceed 4°C/sec and a target of 2°C/sec is preferred.

Chip Size	3216 and smaller	3225 and above
Preheating	$\Delta T \leq 150^\circ\text{C}$	$\Delta T \leq 130^\circ\text{C}$

- Flow Soldering for Lead free Termination

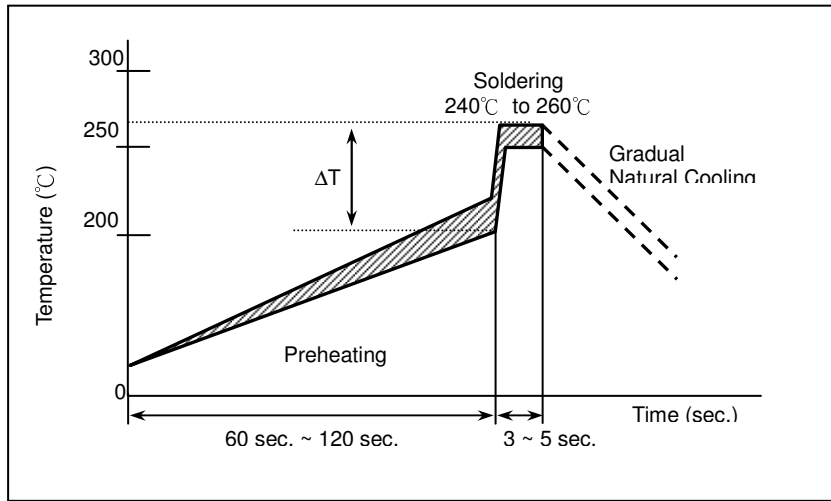

Chip Size	3216 and smaller	3225 and above
Preheating	$\Delta T \leq 150^\circ\text{C}$	-

- Soldering Iron

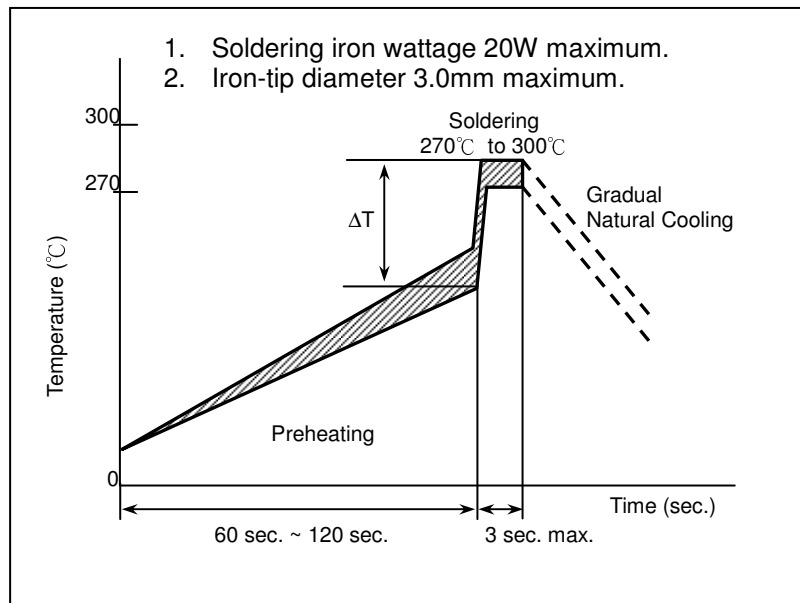

Chip Size	3216 and smaller	3225 and above
Preheating	$\Delta T \leq 190^\circ\text{C}$	$\Delta T \leq 130^\circ\text{C}$

Chip Layout and Breaking PCB

1. To layout the SMD capacitors for reducing bend stress from board deflection of PCB. The following are examples of good and bad layout.

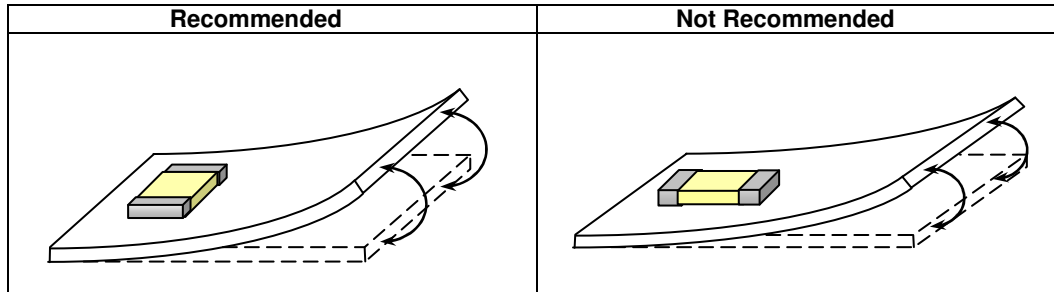

2. When breaking PCB, the layout should be noted that the mechanical stresses are depending on the position of capacitors. The following example shows recommendation for better design.

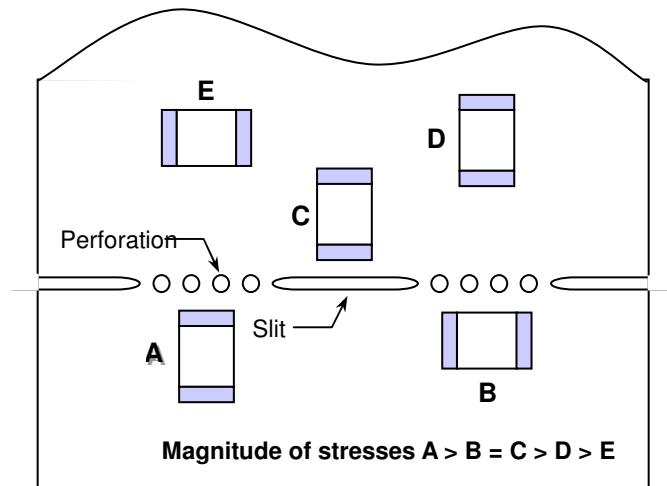

Peeling Off Force

Peeling off force: 0.1N to 1.0N in the direction shown below.

The peeling speed: 300+/-10 mm/min

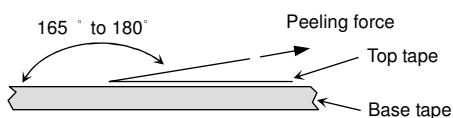

1. The taped tape on reel is wound clockwise. The sprocket holes are to the right as the tape is pulled toward the user.
2. There are minimum 150 mm as the leader and minimum 40 mm empty tape as the tail is attached to the end of the tape.

DARFON ENVIRONMENTAL POLICY

- KEEP ENVIRONMENTAL REGULATION
- ALL MEMBER MUST JOIN THE ENVIRONMENTAL PROTECTION
- KEEP PREVENTION AND TREATMENT
- PROTECT THE NATURAL RESOURCES



CERTIFICATE

TÜV ASIA PACIFIC LIMITED

hereby certifies that

DARFON

DARFON ELECTRONICS CORP.

No. 21, Industry 2nd Road, Tainan 709, Taiwan, R.O.C.

With the plants Tainan Plant, ShenZhen Plants, SuZhou Plants, SuZhou
Precisions Plant, and Huaian Plant according to the annex

has established and applies an Occupational Health & Safety
Management System for

**Design, Manufacturing, Marketing, Sales and Testing of Ceramic
Components, and Electrical Materials
Manufacturing of MLCC(multi-layer ceramic capacitors),
MLCI(multi-layer chip inductor), Magnetic Inductors, Transformers,
Coil Components Lips, Power Boards, Bobbins, Keyboards, and
Metal Stamping
Production of Computer Input Facilities, Pincer Devices and
Integrated Devices
Design and Manufacturing of Mould, Injection/Painting and
Assembly of Plastic Parts**

An audit was performed, Report No. : 2.5-8619/2010

Proof has been furnished that the requirements according to

OHSAS 18001 : 2007

are fulfilled.

The certificate is valid until 27 January 2013

Certificate Registration No: 2010001



Taipei, 28.01.2010

Certification Body
TUV Asia Pacific Ltd.



Certificate Number

TW-HSPM-1221

Issued: 11/23/2007

Revision: N/A

Expiration: 11/22/2010

**IECQ Certificate of Hazardous Substance Process Management (HSPM)
applicable to the European Directive 2002/95/EC ("RoHS") requirements and other
identified Hazardous Substances.**

The Supervising Inspectorate (Underwriters Laboratories Inc.), sponsored by the United States
National Authorized Institution, ECCB certify that

Darfon Electronics Corp.

21, Industry II Road, Annan

Tainan 709,

Taiwan, R.O.C.

Has developed and implemented Hazardous Substance Process Management procedures and related
processes in compliance with the applicable requirements for HSPM organization approval which is
in accordance with the Basic Rules IECQ-01 and Rules of Procedure QC 001002-5 "IECQ
Hazardous Substances Process Management" of the IEC Quality Assessment System for Electronic
Components (IECQ), and with respect to specification of QC 080000 IECQ HSPM

**This certification is applicable to all electronic components and related
materials and processes for the**

Design and manufacture of multi-layer ceramic capacitors (MLCC).

Approved by American
National Authorized Institute

Issued by Certification Authorities:



Electronic Component Certification Board

Signed:

Stanley H. Salot Jr. - President, ECCB



UL File No. A16512
Underwriters Laboratories Inc.

Signed:

John H. Schmidt - Sr. Vice President, Chief Development Officer

The validity of this certificate is maintained through on-going surveillance inspections.
Note: This certificate is valid only in conjunction with the approval document(s). This approval and this certificate may be suspended or
withdrawn in accordance with the Rules of Procedure of the IECQ. This certificate remains the property of Underwriters Laboratories Inc.
and the body which granted it.

X-ON Electronics

Largest Supplier of Electrical and Electronic Components

Click to view similar products for [Multilayer Ceramic Capacitors MLCC - SMD/SMT](#) category:

Click to view products by [Darfon](#) manufacturer:

Other Similar products are found below :

[M39014/02-1225V](#) [M39014/22-0631](#) [D55342E07B523DR-T/R](#) [NCA1206X7R103K50TRPF](#) [NCA1206X7R104K16TRPF](#) [NIN-FB391JTRF](#)
[NIN-FC2R7JTRF](#) [NMC0201X5R474K4TRPF](#) [NMC0402NPO220J50TRPF](#) [NMC0402X5R105K6.3TRPF](#) [NMC0402X5R224K6.3TRPF](#)
[NMC0402X7R103J25TRPF](#) [NMC0402X7R153K16TRPF](#) [NMC0603NPO1R8C50TRPF](#) [NMC0603NPO201J50TRPF](#)
[NMC0603NPO330G50TRPF](#) [NMC0603X5R475M6.3TRPF](#) [NMC0805NPO270J50TRPF](#) [NMC0805NPO820J50TRPF](#)
[NMC0805X7R224K25TRPF](#) [NMC1206X7R102K50TRPF](#) [NMC-H0805X7R472K250TRPF](#) [NMC-L0402NPO7R0C50TRPF](#) [NMC-](#)
[L0603NPO2R2B50TRPF](#) [NMC-P0805NPO221J500TRPLPF](#) [NMC-Q0402NPO8R2D200TRPF](#) [C1206C101J1GAC](#) [C1608C0G2A221J](#)
[C1608X7R1E334K](#) [C2012C0G2A472J](#) [2220J2K00562KXT](#) [1812J2K00332KXT](#) [CDR31BX103AKWR](#) [CDR33BX104AKUR](#)
[CDR33BX683AKUS](#) [CGA2B2C0G1H010C](#) [CGA2B2C0G1H040C](#) [CGA2B2C0G1H050C](#) [CGA2B2C0G1H060D](#) [CGA2B2C0G1H070D](#)
[CGA2B2C0G1H120J](#) [CGA2B2C0G1H151J](#) [CGA2B2C0G1H181JT0Y0F](#) [CGA2B2C0G1H1R5C](#) [CGA2B2C0G1H2R2C](#)
[CGA2B2C0G1H390J](#) [CGA2B2C0G1H391J](#) [CGA2B2C0G1H3R3C](#) [CGA2B2C0G1H680J](#) [CGA2B2C0G1H6R8D](#)