

CONTENT (MLCC)

E STANDARD NUMBER..... 3

STRUCTURE 4

ORDERING CODE 4

GENERAL PURPOSE 5

 CLASS I: TEMPERATURE COMPENSATING TYPE 6

 CLASS II: HIGH DIELECTRIC CONSTANT TYPE 12

X5R Series 12

X6S Series 17

X7R Series 19

X7S Series 28

X7T Series 29

X7U Series 30

Y5V Series 31

 TEST SPEC. 33

PACKAGE 37

OTHERS 41

E Standard Number

| | | | | | | | | | | | | | | | | | | | | | | | | |
|-----|-----|-----|-----|-----|-----|-----|-----|-----|-----|-----|-----|-----|-----|-----|-----|-----|-----|-----|-----|-----|-----|-----|-----|-----|
| E3 | 1.0 | | | | | | 2.2 | | | | | | 4.7 | | | | | | | | | | | |
| E6 | 1.0 | | 1.5 | | | | 2.2 | | | 3.3 | | | 4.7 | | | 6.8 | | | | | | | | |
| E12 | 1.0 | 1.2 | 1.5 | 1.8 | 2.2 | 2.7 | 3.3 | 3.9 | 4.7 | 5.6 | 6.8 | 8.2 | | | | | | | | | | | | |
| E24 | 1.0 | 1.1 | 1.2 | 1.3 | 1.5 | 1.6 | 1.8 | 2.0 | 2.2 | 2.4 | 2.7 | 3.0 | 3.3 | 3.6 | 3.9 | 4.3 | 4.7 | 5.1 | 5.6 | 6.2 | 6.8 | 7.5 | 8.2 | 9.1 |

Structure

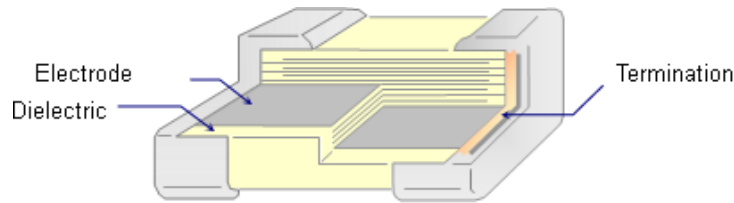

Ordering Code

C 1005 NP0 101 J G T S Δ

PRODUCT CODE

C = MLCC

SIZE in mm (EIA CODE, in inch)

0402(01005) 0603(0201) 1005 (0402) 1608 (0603) 2012 (0805)
 3216 (1206) 3225(1210) 4520 (1808) 4532 (1812)

T. C.

NP0: $0 \pm 30 \text{ppm}/^\circ\text{C}$ -55°C to $+125^\circ\text{C}$ X5R: $\pm 15\%$ -55°C to $+85^\circ\text{C}$
 X7R: $\pm 15\%$ X7S: $\pm 22\%$ X7T: $+22\%/-33\%$ X7U: $+22\%/-56\%$ -55°C to $+125^\circ\text{C}$
 X6S: $\pm 22\%$ -55°C to $+105^\circ\text{C}$ Y5V: $+22\%/-82\%$ -30°C to $+85^\circ\text{C}$

CAPACITANCE CODE

Expressed in pico-farads and identified by a three-digit number.
 First two digits represent significant figures.
 Last digit specifies the number of zeros.
 (Use 9 for 1.0 through 9.9pF ; Use 8 for 0.20 through 0.99pF)

Examples:

| Code | Cap (pF) |
|------|----------|
| 478 | 0.47 |
| 229 | 2.2 |
| 101 | 100 |
| 102 | 1000 |

TOLERANCE CODE

A: $\pm 0.05\text{pF}$ B: $\pm 0.1\text{pF}$ C: $\pm 0.25\text{pF}$ D: $\pm 0.5\text{pF}$ F: $\pm 1\%$ G: $\pm 2\%$
 J: $\pm 5\%$ K: $\pm 10\%$ M: $\pm 20\%$ Z: $+80\%/-20\%$

VOLTAGE CODE

B: 4V C: 6.3V D: 10V E: 16V F: 25V N: 35V G: 50V H: 100V
 J: 200V K: 250V L: 500V M: 630V P: 1KV Q: 2KV R: 3KV S: 4KV

PACKAGING CODE

T: Paper tape reel $\varnothing 180\text{mm}$ (7") P: Embossed tape reel $\varnothing 180\text{mm}$ (7")
 N: Paper tape reel $\varnothing 250\text{mm}$ (10") D: Embossed tape reel $\varnothing 250\text{mm}$ (10")
 A: Paper tape reel $\varnothing 330\text{mm}$ (13") E: Embossed tape reel $\varnothing 330\text{mm}$ (13")
 W: Special Packing

Application Code

S: Standard Q: High Q/Low ESR F: Microwave A: Automotive Infotainment with AEC-Q200

Thickness Code

| Code | Thick (mm) | Code | Thick(mm) | Code | Thick (mm) | Code | Thick (mm) |
|---------|----------------|------|-----------|------|------------|------|------------|
| (blank) | Standard Thick | M | 0.70 | G | 1.25 | S | 1.90 |
| Z | 0.20 | D | 0.80 | H | 1.50 | -- | -- |
| A | 0.30 | E | 0.85 | L | 1.60 | -- | -- |
| Q | 0.45 | I | 0.95 | N | 2.00 | -- | -- |
| B | 0.50 | J | 1.00 | P | 2.50 | -- | -- |
| C | 0.60 | F | 1.15 | R | 3.20 | -- | -- |

General Purpose

■ External Dimensions



| TYPE | | Dimension (mm) | | | | |
|-----------------|-------------|----------------|-------------|----------|---------|-------------|
| Size (EIA Size) | Kind | L (Length) | W (Width) | T (Max.) | g (Min) | A (Min/Max) |
| C0603 (0201) | Standard | 0.6 ± 0.03 | 0.30 ± 0.03 | 0.33 | 0.15 | 0.10 / 0.20 |
| | Special (1) | 0.6 ± 0.05 | 0.30 ± 0.05 | 0.35 | | |
| | Special (2) | 0.6 ± 0.09 | 0.30 ± 0.09 | 0.39 | | 0.10 / 0.25 |
| C1005 (0402) | Standard | 1.0 ± 0.05 | 0.50 ± 0.05 | 0.55 | 0.30 | 0.15 / 0.35 |
| | Special (1) | 1.0 ± 0.10 | 0.50 ± 0.10 | 0.60 | | |
| | Special (2) | 1.0 ± 0.15 | 0.50 ± 0.15 | 0.65 | | |
| C1608 (0603) | Standard | 1.0 ± 0.20 | 0.50 ± 0.20 | 0.70 | 0.50 | 0.25 / 0.65 |
| | Special (1) | 1.6 ± 0.10 | 0.80 ± 0.10 | 0.90 | | |
| | Special (2) | 1.6 ± 0.15 | 0.80 ± 0.15 | 0.95 | | |
| C2012 (0805) | Standard | 1.6 ± 0.20 | 0.80 ± 0.20 | 1.00 | 0.70 | 0.25 / 0.75 |
| | Special (1) | 1.6 ± 0.25 | 0.80 ± 0.25 | 1.05 | | |
| | Standard | 2.0 ± 0.15 | 1.25 ± 0.15 | 1.45 | | |
| C3216 (1206) | Standard | 2.0 ± 0.20 | 1.25 ± 0.20 | 1.45 | 1.50 | 0.25 / 0.75 |
| | Special (1) | 3.2 ± 0.15 | 1.60 ± 0.15 | 1.80 | | |
| | Special (2) | 3.2 ± 0.20 | 1.60 ± 0.20 | 1.90 | | |
| C3225 (1210) | Standard | 3.2 ± 0.30 | 1.60 ± 0.30 | 1.90 | 1.50 | 0.3 / 0.90 |
| | Special (1) | 3.2 ± 0.30 | 2.50 ± 0.20 | 2.80 | | |
| | Special (1) | 3.2 ± 0.40 | 2.50 ± 0.30 | 2.80 | | |

For special parts, please see the "Part Number & Characteristic" for detail specification.

● Class I: Temperature Compensating Type

■ Feature

1. Ultra-stable
2. Tight tolerance available
3. Low ESR (Frequency is within 800MHz)
4. Good frequency performance
5. No aging of capacitance
6. RoHS compliant
7. Halogen Free

■ Application

1. LC and RC tuned circuit
2. Filtering
3. Timing

■ Part Number & Characteristic

● C0603NP0_S Series (EIA0201)

| RV | DARFON P/N | DARFON P/N 2 | Measuring Condition | Capacitance | | Available Tolerance | Thick. (mm) | Tolerance(mm) | | DF (max.) | Standard Packing |
|-------------|-------------|--------------|---------------------|-------------|-------------|------------------------|-------------|---------------|--------|-----------|------------------|
| | | | | Value | Unit | | | L/W | Thick. | | |
| 50V | C0603NP0208 | C0603NP0208 | 1V, 1MHz | 0.20 | pF | ±0.25pF,±0.1pF,±0.05pF | 0.30 | ±0.03 | ±0.03 | 0.25% | Paper,15Kpcs |
| | C0603NP0308 | C0603NP0308 | 1V, 1MHz | 0.30 | pF | ±0.25pF,±0.1pF,±0.05pF | 0.30 | ±0.03 | ±0.03 | 0.25% | |
| | C0603NP0408 | C0603NP0408 | 1V, 1MHz | 0.40 | pF | ±0.25pF,±0.1pF,±0.05pF | 0.30 | ±0.03 | ±0.03 | 0.25% | |
| | C0603NP0508 | C0603NP0508 | 1V, 1MHz | 0.50 | pF | ±0.25pF,±0.1pF,±0.05pF | 0.30 | ±0.03 | ±0.03 | 0.24% | |
| | C0603NP0608 | C0603NP0608 | 1V, 1MHz | 0.60 | pF | ±0.25pF,±0.1pF,±0.05pF | 0.30 | ±0.03 | ±0.03 | 0.24% | |
| | C0603NP0708 | C0603NP0708 | 1V, 1MHz | 0.70 | pF | ±0.25pF,±0.1pF,±0.05pF | 0.30 | ±0.03 | ±0.03 | 0.24% | |
| | C0603NP0758 | C0603NP0758 | 1V, 1MHz | 0.75 | pF | ±0.25pF,±0.1pF,±0.05pF | 0.30 | ±0.03 | ±0.03 | 0.24% | |
| | C0603NP0808 | C0603NP0808 | 1V, 1MHz | 0.80 | pF | ±0.25pF,±0.1pF,±0.05pF | 0.30 | ±0.03 | ±0.03 | 0.24% | |
| | C0603NP0908 | C0603NP0908 | 1V, 1MHz | 0.90 | pF | ±0.25pF,±0.1pF,±0.05pF | 0.30 | ±0.03 | ±0.03 | 0.24% | |
| | C0603NP0109 | C0603NP0109 | 1V, 1MHz | 1.0 | pF | ±0.25pF,±0.1pF,±0.05pF | 0.30 | ±0.03 | ±0.03 | 0.24% | |
| | C0603NP0119 | C0603NP0119 | 1V, 1MHz | 1.1 | pF | ±0.25pF,±0.1pF | 0.30 | ±0.03 | ±0.03 | 0.24% | |
| | C0603NP0129 | C0603NP0129 | 1V, 1MHz | 1.2 | pF | ±0.25pF,±0.1pF | 0.30 | ±0.03 | ±0.03 | 0.24% | |
| | C0603NP0139 | C0603NP0139 | 1V, 1MHz | 1.3 | pF | ±0.25pF,±0.1pF | 0.30 | ±0.03 | ±0.03 | 0.23% | |
| | C0603NP0159 | C0603NP0159 | 1V, 1MHz | 1.5 | pF | ±0.25pF,±0.1pF | 0.30 | ±0.03 | ±0.03 | 0.23% | |
| | C0603NP0169 | C0603NP0169 | 1V, 1MHz | 1.6 | pF | ±0.25pF,±0.1pF | 0.30 | ±0.03 | ±0.03 | 0.23% | |
| | C0603NP0189 | C0603NP0189 | 1V, 1MHz | 1.8 | pF | ±0.25pF,±0.1pF | 0.30 | ±0.03 | ±0.03 | 0.23% | |
| | C0603NP0209 | C0603NP0209 | 1V, 1MHz | 2.0 | pF | ±0.25pF,±0.1pF | 0.30 | ±0.03 | ±0.03 | 0.23% | |
| | C0603NP0229 | C0603NP0229 | 1V, 1MHz | 2.2 | pF | ±0.25pF,±0.1pF | 0.30 | ±0.03 | ±0.03 | 0.23% | |
| | C0603NP0249 | C0603NP0249 | 1V, 1MHz | 2.4 | pF | ±0.25pF,±0.1pF | 0.30 | ±0.03 | ±0.03 | 0.22% | |
| | C0603NP0279 | C0603NP0279 | 1V, 1MHz | 2.7 | pF | ±0.25pF,±0.1pF | 0.30 | ±0.03 | ±0.03 | 0.22% | |
| | C0603NP0309 | C0603NP0309 | 1V, 1MHz | 3.0 | pF | ±0.25pF,±0.1pF | 0.30 | ±0.03 | ±0.03 | 0.22% | |
| | C0603NP0339 | C0603NP0339 | 1V, 1MHz | 3.3 | pF | ±0.25pF,±0.1pF | 0.30 | ±0.03 | ±0.03 | 0.21% | |
| | C0603NP0359 | C0603NP0359 | 1V, 1MHz | 3.5 | pF | ±0.25pF,±0.1pF | 0.30 | ±0.03 | ±0.03 | 0.21% | |
| | C0603NP0399 | C0603NP0399 | 1V, 1MHz | 3.9 | pF | ±0.25pF,±0.1pF | 0.30 | ±0.03 | ±0.03 | 0.21% | |
| | C0603NP0409 | C0603NP0409 | 1V, 1MHz | 4.0 | pF | ±0.25pF,±0.1pF | 0.30 | ±0.03 | ±0.03 | 0.21% | |
| | C0603NP0439 | C0603NP0439 | 1V, 1MHz | 4.3 | pF | ±0.25pF,±0.1pF | 0.30 | ±0.03 | ±0.03 | 0.21% | |
| | C0603NP0479 | C0603NP0479 | 1V, 1MHz | 4.7 | pF | ±0.25pF,±0.1pF | 0.30 | ±0.03 | ±0.03 | 0.20% | |
| | C0603NP0509 | C0603NP0509 | 1V, 1MHz | 5.0 | pF | ±0.5pF,±0.25pF,±0.1pF | 0.30 | ±0.03 | ±0.03 | 0.20% | |
| | C0603NP0519 | C0603NP0519 | 1V, 1MHz | 5.1 | pF | ±0.5pF,±0.25pF,±0.1pF | 0.30 | ±0.03 | ±0.03 | 0.20% | |
| | C0603NP0569 | C0603NP0569 | 1V, 1MHz | 5.6 | pF | ±0.5pF,±0.25pF,±0.1pF | 0.30 | ±0.03 | ±0.03 | 0.20% | |
| | C0603NP0609 | C0603NP0609 | 1V, 1MHz | 6.0 | pF | ±0.5pF,±0.25pF,±0.1pF | 0.30 | ±0.03 | ±0.03 | 0.19% | |
| | C0603NP0629 | C0603NP0629 | 1V, 1MHz | 6.2 | pF | ±0.5pF,±0.25pF,±0.1pF | 0.30 | ±0.03 | ±0.03 | 0.19% | |
| | C0603NP0689 | C0603NP0689 | 1V, 1MHz | 6.8 | pF | ±0.5pF,±0.25pF,±0.1pF | 0.30 | ±0.03 | ±0.03 | 0.19% | |
| | C0603NP0709 | C0603NP0709 | 1V, 1MHz | 7.0 | pF | ±0.5pF,±0.25pF,±0.1pF | 0.30 | ±0.03 | ±0.03 | 0.19% | |
| | C0603NP0759 | C0603NP0759 | 1V, 1MHz | 7.5 | pF | ±0.5pF,±0.25pF,±0.1pF | 0.30 | ±0.03 | ±0.03 | 0.18% | |
| | C0603NP0809 | C0603NP0809 | 1V, 1MHz | 8.0 | pF | ±0.5pF,±0.25pF,±0.1pF | 0.30 | ±0.03 | ±0.03 | 0.18% | |
| | C0603NP0829 | C0603NP0829 | 1V, 1MHz | 8.2 | pF | ±0.5pF,±0.25pF,±0.1pF | 0.30 | ±0.03 | ±0.03 | 0.18% | |
| | C0603NP0909 | C0603NP0909 | 1V, 1MHz | 9.0 | pF | ±0.5pF,±0.25pF,±0.1pF | 0.30 | ±0.03 | ±0.03 | 0.17% | |
| | C0603NP0100 | C0603NP0100 | 1V, 1MHz | 10 | pF | ±5%,±2%,±1% | 0.30 | ±0.03 | ±0.03 | 0.17% | |
| | C0603NP0120 | C0603NP0120 | 1V, 1MHz | 12 | pF | ±5%,±2%,±1% | 0.30 | ±0.03 | ±0.03 | 0.16% | |
| C0603NP0150 | C0603NP0150 | 1V, 1MHz | 15 | pF | ±5%,±2%,±1% | 0.30 | ±0.03 | ±0.03 | 0.14% | | |
| C0603NP0180 | C0603NP0180 | 1V, 1MHz | 18 | pF | ±5%,±2%,±1% | 0.30 | ±0.03 | ±0.03 | 0.13% | | |
| C0603NP0200 | C0603NP0200 | 1V, 1MHz | 20 | pF | ±5%,±2%,±1% | 0.30 | ±0.03 | ±0.03 | 0.13% | | |
| C0603NP0220 | C0603NP0220 | 1V, 1MHz | 22 | pF | ±5%,±2%,±1% | 0.30 | ±0.03 | ±0.03 | 0.12% | | |
| C0603NP0270 | C0603NP0270 | 1V, 1MHz | 27 | pF | ±5%,±2%,±1% | 0.30 | ±0.03 | ±0.03 | 0.11% | | |
| C0603NP0330 | C0603NP0330 | 1V, 1MHz | 33 | pF | ±5%,±2%,±1% | 0.30 | ±0.03 | ±0.03 | 0.10% | | |
| C0603NP0390 | C0603NP0390 | 1V, 1MHz | 39 | pF | ±5%,±2%,±1% | 0.30 | ±0.03 | ±0.03 | 0.10% | | |
| C0603NP0470 | C0603NP0470 | 1V, 1MHz | 47 | pF | ±5%,±2%,±1% | 0.30 | ±0.03 | ±0.03 | 0.10% | | |
| C0603NP0560 | C0603NP0560 | 1V, 1MHz | 56 | pF | ±5%,±2%,±1% | 0.30 | ±0.03 | ±0.03 | 0.10% | | |
| C0603NP0680 | C0603NP0680 | 1V, 1MHz | 68 | pF | ±5%,±2%,±1% | 0.30 | ±0.03 | ±0.03 | 0.10% | | |
| C0603NP0820 | C0603NP0820 | 1V, 1MHz | 82 | pF | ±5%,±2%,±1% | 0.30 | ±0.03 | ±0.03 | 0.10% | | |
| C0603NP0101 | C0603NP0101 | 1V, 1MHz | 100 | pF | ±5%,±2%,±1% | 0.30 | ±0.03 | ±0.03 | 0.10% | | |

□ Tolerance Code: A=±0.05 pF, B=±0.1pF, C=±0.25pF, D=±0.5pF, F=±1%, G=±2%, J=±5%; Special tolerance on the request.

| RV | DARFON P/N | DARFON P/N 2 | Measuring Condition | Capacitance | | Available Tolerance | Thick. (mm) | Tolerance(mm) | | DF (max.) | Standard Packing |
|-------------|-------------|--------------|---------------------|-------------|-------------|------------------------|-------------|---------------|--------|-----------|------------------|
| | | | | Value | Unit | | | L/W | Thick. | | |
| 25V | C0603NP0208 | C0603NP0208 | 1V, 1MHz | 0.20 | pF | ±0.25pF,±0.1pF,±0.05pF | 0.30 | ±0.03 | ±0.03 | 0.25% | Paper,15Kpcs |
| | C0603NP0308 | C0603NP0308 | 1V, 1MHz | 0.30 | pF | ±0.25pF,±0.1pF,±0.05pF | 0.30 | ±0.03 | ±0.03 | 0.25% | |
| | C0603NP0408 | C0603NP0408 | 1V, 1MHz | 0.40 | pF | ±0.25pF,±0.1pF,±0.05pF | 0.30 | ±0.03 | ±0.03 | 0.25% | |
| | C0603NP0508 | C0603NP0508 | 1V, 1MHz | 0.50 | pF | ±0.25pF,±0.1pF,±0.05pF | 0.30 | ±0.03 | ±0.03 | 0.24% | |
| | C0603NP0608 | C0603NP0608 | 1V, 1MHz | 0.60 | pF | ±0.25pF,±0.1pF,±0.05pF | 0.30 | ±0.03 | ±0.03 | 0.24% | |
| | C0603NP0708 | C0603NP0708 | 1V, 1MHz | 0.70 | pF | ±0.25pF,±0.1pF,±0.05pF | 0.30 | ±0.03 | ±0.03 | 0.24% | |
| | C0603NP0758 | C0603NP0758 | 1V, 1MHz | 0.75 | pF | ±0.25pF,±0.1pF,±0.05pF | 0.30 | ±0.03 | ±0.03 | 0.24% | |
| | C0603NP0808 | C0603NP0808 | 1V, 1MHz | 0.80 | pF | ±0.25pF,±0.1pF,±0.05pF | 0.30 | ±0.03 | ±0.03 | 0.24% | |
| | C0603NP0908 | C0603NP0908 | 1V, 1MHz | 0.90 | pF | ±0.25pF,±0.1pF,±0.05pF | 0.30 | ±0.03 | ±0.03 | 0.24% | |
| | C0603NP0109 | C0603NP0109 | 1V, 1MHz | 1.0 | pF | ±0.25pF,±0.1pF,±0.05pF | 0.30 | ±0.03 | ±0.03 | 0.24% | |
| | C0603NP0129 | C0603NP0129 | 1V, 1MHz | 1.2 | pF | ±0.25pF,±0.1pF | 0.30 | ±0.03 | ±0.03 | 0.24% | |
| | C0603NP0139 | C0603NP0139 | 1V, 1MHz | 1.3 | pF | ±0.25pF,±0.1pF | 0.30 | ±0.03 | ±0.03 | 0.23% | |
| | C0603NP0159 | C0603NP0159 | 1V, 1MHz | 1.5 | pF | ±0.25pF,±0.1pF | 0.30 | ±0.03 | ±0.03 | 0.23% | |
| | C0603NP0169 | C0603NP0169 | 1V, 1MHz | 1.6 | pF | ±0.25pF,±0.1pF | 0.30 | ±0.03 | ±0.03 | 0.23% | |
| | C0603NP0189 | C0603NP0189 | 1V, 1MHz | 1.8 | pF | ±0.25pF,±0.1pF | 0.30 | ±0.03 | ±0.03 | 0.23% | |
| | C0603NP0209 | C0603NP0209 | 1V, 1MHz | 2.0 | pF | ±0.25pF,±0.1pF | 0.30 | ±0.03 | ±0.03 | 0.23% | |
| | C0603NP0229 | C0603NP0229 | 1V, 1MHz | 2.2 | pF | ±0.25pF,±0.1pF | 0.30 | ±0.03 | ±0.03 | 0.23% | |
| | C0603NP0279 | C0603NP0279 | 1V, 1MHz | 2.7 | pF | ±0.25pF,±0.1pF | 0.30 | ±0.03 | ±0.03 | 0.22% | |
| | C0603NP0309 | C0603NP0309 | 1V, 1MHz | 3.0 | pF | ±0.25pF,±0.1pF | 0.30 | ±0.03 | ±0.03 | 0.22% | |
| | C0603NP0339 | C0603NP0339 | 1V, 1MHz | 3.3 | pF | ±0.25pF,±0.1pF | 0.30 | ±0.03 | ±0.03 | 0.21% | |
| | C0603NP0359 | C0603NP0359 | 1V, 1MHz | 3.5 | pF | ±0.25pF,±0.1pF | 0.30 | ±0.03 | ±0.03 | 0.21% | |
| | C0603NP0399 | C0603NP0399 | 1V, 1MHz | 3.9 | pF | ±0.25pF,±0.1pF | 0.30 | ±0.03 | ±0.03 | 0.21% | |
| | C0603NP0409 | C0603NP0409 | 1V, 1MHz | 4.0 | pF | ±0.25pF,±0.1pF | 0.30 | ±0.03 | ±0.03 | 0.21% | |
| | C0603NP0439 | C0603NP0439 | 1V, 1MHz | 4.3 | pF | ±0.25pF,±0.1pF | 0.30 | ±0.03 | ±0.03 | 0.21% | |
| | C0603NP0479 | C0603NP0479 | 1V, 1MHz | 4.7 | pF | ±0.25pF,±0.1pF | 0.30 | ±0.03 | ±0.03 | 0.20% | |
| | C0603NP0509 | C0603NP0509 | 1V, 1MHz | 5.0 | pF | ±0.5pF,±0.25pF,±0.1pF | 0.30 | ±0.03 | ±0.03 | 0.20% | |
| | C0603NP0519 | C0603NP0519 | 1V, 1MHz | 5.1 | pF | ±0.5pF,±0.25pF,±0.1pF | 0.30 | ±0.03 | ±0.03 | 0.20% | |
| | C0603NP0569 | C0603NP0569 | 1V, 1MHz | 5.6 | pF | ±0.5pF,±0.25pF,±0.1pF | 0.30 | ±0.03 | ±0.03 | 0.20% | |
| | C0603NP0609 | C0603NP0609 | 1V, 1MHz | 6.0 | pF | ±0.5pF,±0.25pF,±0.1pF | 0.30 | ±0.03 | ±0.03 | 0.19% | |
| | C0603NP0629 | C0603NP0629 | 1V, 1MHz | 6.2 | pF | ±0.5pF,±0.25pF,±0.1pF | 0.30 | ±0.03 | ±0.03 | 0.19% | |
| | C0603NP0689 | C0603NP0689 | 1V, 1MHz | 6.8 | pF | ±0.5pF,±0.25pF,±0.1pF | 0.30 | ±0.03 | ±0.03 | 0.19% | |
| | C0603NP0709 | C0603NP0709 | 1V, 1MHz | 7.0 | pF | ±0.5pF,±0.25pF,±0.1pF | 0.30 | ±0.03 | ±0.03 | 0.19% | |
| | C0603NP0759 | C0603NP0759 | 1V, 1MHz | 7.5 | pF | ±0.5pF,±0.25pF,±0.1pF | 0.30 | ±0.03 | ±0.03 | 0.18% | |
| | C0603NP0809 | C0603NP0809 | 1V, 1MHz | 8.0 | pF | ±0.5pF,±0.25pF,±0.1pF | 0.30 | ±0.03 | ±0.03 | 0.18% | |
| | C0603NP0829 | C0603NP0829 | 1V, 1MHz | 8.2 | pF | ±0.5pF,±0.25pF,±0.1pF | 0.30 | ±0.03 | ±0.03 | 0.18% | |
| | C0603NP0909 | C0603NP0909 | 1V, 1MHz | 9.0 | pF | ±0.5pF,±0.25pF,±0.1pF | 0.30 | ±0.03 | ±0.03 | 0.17% | |
| | C0603NP0919 | C0603NP0919 | 1V, 1MHz | 9.1 | pF | ±0.5pF,±0.25pF,±0.1pF | 0.30 | ±0.03 | ±0.03 | 0.17% | |
| | C0603NP0100 | C0603NP0100 | 1V, 1MHz | 10 | pF | ±5%,±2%,±1% | 0.30 | ±0.03 | ±0.03 | 0.17% | |
| | C0603NP0120 | C0603NP0120 | 1V, 1MHz | 12 | pF | ±5%,±2%,±1% | 0.30 | ±0.03 | ±0.03 | 0.16% | |
| | C0603NP0150 | C0603NP0150 | 1V, 1MHz | 15 | pF | ±5%,±2%,±1% | 0.30 | ±0.03 | ±0.03 | 0.14% | |
| C0603NP0180 | C0603NP0180 | 1V, 1MHz | 18 | pF | ±5%,±2%,±1% | 0.30 | ±0.03 | ±0.03 | 0.13% | | |
| C0603NP0200 | C0603NP0200 | 1V, 1MHz | 20 | pF | ±5%,±2%,±1% | 0.30 | ±0.03 | ±0.03 | 0.13% | | |
| C0603NP0220 | C0603NP0220 | 1V, 1MHz | 22 | pF | ±5%,±2%,±1% | 0.30 | ±0.03 | ±0.03 | 0.12% | | |
| C0603NP0240 | C0603NP0240 | 1V, 1MHz | 24 | pF | ±5%,±2%,±1% | 0.30 | ±0.03 | ±0.03 | 0.11% | | |
| C0603NP0270 | C0603NP0270 | 1V, 1MHz | 27 | pF | ±5%,±2%,±1% | 0.30 | ±0.03 | ±0.03 | 0.11% | | |
| C0603NP0300 | C0603NP0300 | 1V, 1MHz | 30 | pF | ±5% | 0.30 | ±0.03 | ±0.03 | 0.10% | | |
| C0603NP0330 | C0603NP0330 | 1V, 1MHz | 33 | pF | ±5%,±2%,±1% | 0.30 | ±0.03 | ±0.03 | 0.10% | | |
| C0603NP0390 | C0603NP0390 | 1V, 1MHz | 39 | pF | ±5%,±2%,±1% | 0.30 | ±0.03 | ±0.03 | 0.10% | | |
| C0603NP0470 | C0603NP0470 | 1V, 1MHz | 47 | pF | ±5%,±2%,±1% | 0.30 | ±0.03 | ±0.03 | 0.10% | | |
| C0603NP0560 | C0603NP0560 | 1V, 1MHz | 56 | pF | ±5%,±2%,±1% | 0.30 | ±0.03 | ±0.03 | 0.10% | | |
| C0603NP0680 | C0603NP0680 | 1V, 1MHz | 68 | pF | ±5%,±2%,±1% | 0.30 | ±0.03 | ±0.03 | 0.10% | | |
| C0603NP0820 | C0603NP0820 | 1V, 1MHz | 82 | pF | ±5%,±2%,±1% | 0.30 | ±0.03 | ±0.03 | 0.10% | | |
| C0603NP0101 | C0603NP0101 | 1V, 1MHz | 100 | pF | ±5%,±2%,±1% | 0.30 | ±0.03 | ±0.03 | 0.10% | | |
| 16V | C0603NP0279 | C0603NP0279 | 1V, 1MHz | 2.7 | pF | ±0.25pF,±0.1pF | 0.30 | ±0.03 | ±0.03 | 0.22% | Paper,15Kpcs |
| | C0603NP0330 | C0603NP0330 | 1V, 1MHz | 33 | pF | ±5%,±2%,±1% | 0.30 | ±0.03 | ±0.03 | 0.10% | |

● C1005NP0_S Series (EIA0402)

| RV | DARFON P/N | DARFON P/N 2 | Measuring Condition | Capacitance | | Available Tolerance | Thick. (mm) | Tolerance(mm) | | DF (max.) | Standard Packing |
|-------------|-------------|--------------|---------------------|-------------|------------------|------------------------|-------------|---------------|--------|-----------|------------------|
| | | | | Value | Unit | | | L/W | Thick. | | |
| 50V | C1005NP0208 | C1005NP0208 | 1V, 1MHz | 0.20 | pF | ±0.25pF,±0.1pF,±0.05pF | 0.50 | ±0.05 | ±0.05 | 0.25% | |
| | C1005NP0308 | C1005NP0308 | 1V, 1MHz | 0.30 | pF | ±0.25pF,±0.1pF,±0.05pF | 0.50 | ±0.05 | ±0.05 | 0.25% | |
| | C1005NP0408 | C1005NP0408 | 1V, 1MHz | 0.40 | pF | ±0.25pF,±0.1pF,±0.05pF | 0.50 | ±0.05 | ±0.05 | 0.25% | |
| | C1005NP0508 | C1005NP0508 | 1V, 1MHz | 0.50 | pF | ±0.25pF,±0.1pF,±0.05pF | 0.50 | ±0.05 | ±0.05 | 0.24% | |
| | C1005NP0608 | C1005NP0608 | 1V, 1MHz | 0.60 | pF | ±0.25pF,±0.1pF,±0.05pF | 0.50 | ±0.05 | ±0.05 | 0.24% | |
| | C1005NP0688 | C1005NP0688 | 1V, 1MHz | 0.68 | pF | ±0.25pF,±0.1pF,±0.05pF | 0.50 | ±0.05 | ±0.05 | 0.24% | |
| | C1005NP0708 | C1005NP0708 | 1V, 1MHz | 0.70 | pF | ±0.25pF,±0.1pF,±0.05pF | 0.50 | ±0.05 | ±0.05 | 0.24% | |
| | C1005NP0808 | C1005NP0808 | 1V, 1MHz | 0.80 | pF | ±0.25pF,±0.1pF,±0.05pF | 0.50 | ±0.05 | ±0.05 | 0.24% | |
| | C1005NP0828 | C1005NP0828 | 1V, 1MHz | 0.82 | pF | ±0.25pF,±0.1pF,±0.05pF | 0.50 | ±0.05 | ±0.05 | 0.24% | |
| | C1005NP0908 | C1005NP0908 | 1V, 1MHz | 0.90 | pF | ±0.25pF,±0.1pF,±0.05pF | 0.50 | ±0.05 | ±0.05 | 0.24% | |
| | C1005NP0109 | C1005NP0109 | 1V, 1MHz | 1.0 | pF | ±0.25pF,±0.1pF,±0.05pF | 0.50 | ±0.05 | ±0.05 | 0.24% | |
| | C1005NP0129 | C1005NP0129 | 1V, 1MHz | 1.2 | pF | ±0.25pF,±0.1pF,±0.05pF | 0.50 | ±0.05 | ±0.05 | 0.24% | |
| | C1005NP0139 | C1005NP0139 | 1V, 1MHz | 1.3 | pF | ±0.25pF,±0.1pF,±0.05pF | 0.50 | ±0.05 | ±0.05 | 0.23% | |
| | C1005NP0159 | C1005NP0159 | 1V, 1MHz | 1.5 | pF | ±0.25pF,±0.1pF,±0.05pF | 0.50 | ±0.05 | ±0.05 | 0.23% | |
| | C1005NP0189 | C1005NP0189 | 1V, 1MHz | 1.8 | pF | ±0.25pF,±0.1pF,±0.05pF | 0.50 | ±0.05 | ±0.05 | 0.23% | |
| | C1005NP0209 | C1005NP0209 | 1V, 1MHz | 2.0 | pF | ±0.25pF,±0.1pF,±0.05pF | 0.50 | ±0.05 | ±0.05 | 0.23% | |
| | C1005NP0229 | C1005NP0229 | 1V, 1MHz | 2.2 | pF | ±0.25pF,±0.1pF,±0.05pF | 0.50 | ±0.05 | ±0.05 | 0.23% | |
| | C1005NP0249 | C1005NP0249 | 1V, 1MHz | 2.4 | pF | ±0.25pF,±0.1pF,±0.05pF | 0.50 | ±0.05 | ±0.05 | 0.22% | |
| | C1005NP0259 | C1005NP0259 | 1V, 1MHz | 2.5 | pF | ±0.25pF,±0.1pF,±0.05pF | 0.50 | ±0.05 | ±0.05 | 0.22% | |
| | C1005NP0279 | C1005NP0279 | 1V, 1MHz | 2.7 | pF | ±0.25pF,±0.1pF,±0.05pF | 0.50 | ±0.05 | ±0.05 | 0.22% | |
| | C1005NP0309 | C1005NP0309 | 1V, 1MHz | 3.0 | pF | ±0.25pF,±0.1pF,±0.05pF | 0.50 | ±0.05 | ±0.05 | 0.22% | |
| | C1005NP0339 | C1005NP0339 | 1V, 1MHz | 3.3 | pF | ±0.25pF,±0.1pF,±0.05pF | 0.50 | ±0.05 | ±0.05 | 0.21% | |
| | C1005NP0369 | C1005NP0369 | 1V, 1MHz | 3.6 | pF | ±0.25pF,±0.1pF,±0.05pF | 0.50 | ±0.05 | ±0.05 | 0.21% | |
| | C1005NP0399 | C1005NP0399 | 1V, 1MHz | 3.9 | pF | ±0.25pF,±0.1pF,±0.05pF | 0.50 | ±0.05 | ±0.05 | 0.21% | |
| | C1005NP0409 | C1005NP0409 | 1V, 1MHz | 4.0 | pF | ±0.25pF,±0.1pF,±0.05pF | 0.50 | ±0.05 | ±0.05 | 0.21% | |
| | C1005NP0439 | C1005NP0439 | 1V, 1MHz | 4.3 | pF | ±0.25pF,±0.1pF,±0.05pF | 0.50 | ±0.05 | ±0.05 | 0.21% | |
| | C1005NP0479 | C1005NP0479 | 1V, 1MHz | 4.7 | pF | ±0.25pF,±0.1pF,±0.05pF | 0.50 | ±0.05 | ±0.05 | 0.20% | |
| | C1005NP0509 | C1005NP0509 | 1V, 1MHz | 5.0 | pF | ±0.5pF,±0.25pF,±0.1pF | 0.50 | ±0.05 | ±0.05 | 0.20% | |
| | C1005NP0519 | C1005NP0519 | 1V, 1MHz | 5.1 | pF | ±0.5pF,±0.25pF,±0.1pF | 0.50 | ±0.05 | ±0.05 | 0.20% | |
| | C1005NP0569 | C1005NP0569 | 1V, 1MHz | 5.6 | pF | ±0.5pF,±0.25pF,±0.1pF | 0.50 | ±0.05 | ±0.05 | 0.20% | |
| | C1005NP0609 | C1005NP0609 | 1V, 1MHz | 6.0 | pF | ±0.5pF,±0.25pF,±0.1pF | 0.50 | ±0.05 | ±0.05 | 0.19% | |
| | C1005NP0629 | C1005NP0629 | 1V, 1MHz | 6.2 | pF | ±0.5pF,±0.25pF,±0.1pF | 0.50 | ±0.05 | ±0.05 | 0.19% | |
| | C1005NP0689 | C1005NP0689 | 1V, 1MHz | 6.8 | pF | ±0.5pF,±0.25pF,±0.1pF | 0.50 | ±0.05 | ±0.05 | 0.19% | |
| | C1005NP0709 | C1005NP0709 | 1V, 1MHz | 7.0 | pF | ±0.5pF,±0.25pF,±0.1pF | 0.50 | ±0.05 | ±0.05 | 0.19% | |
| | C1005NP0759 | C1005NP0759 | 1V, 1MHz | 7.5 | pF | ±0.5pF,±0.25pF,±0.1pF | 0.50 | ±0.05 | ±0.05 | 0.18% | |
| | C1005NP0809 | C1005NP0809 | 1V, 1MHz | 8.0 | pF | ±0.5pF,±0.25pF,±0.1pF | 0.50 | ±0.05 | ±0.05 | 0.18% | |
| | C1005NP0829 | C1005NP0829 | 1V, 1MHz | 8.2 | pF | ±0.5pF,±0.25pF,±0.1pF | 0.50 | ±0.05 | ±0.05 | 0.18% | |
| | C1005NP0909 | C1005NP0909 | 1V, 1MHz | 9.0 | pF | ±0.5pF,±0.25pF,±0.1pF | 0.50 | ±0.05 | ±0.05 | 0.17% | |
| | C1005NP0919 | C1005NP0919 | 1V, 1MHz | 9.1 | pF | ±0.5pF,±0.25pF,±0.1pF | 0.50 | ±0.05 | ±0.05 | 0.17% | |
| | C1005NP0100 | C1005NP0100 | 1V, 1MHz | 10 | pF | ±5%,±2%,±1% | 0.50 | ±0.05 | ±0.05 | 0.17% | |
| | C1005NP0110 | C1005NP0110 | 1V, 1MHz | 11 | pF | ±5%,±2%,±1% | 0.50 | ±0.05 | ±0.05 | 0.16% | |
| | C1005NP0120 | C1005NP0120 | 1V, 1MHz | 12 | pF | ±5%,±2%,±1% | 0.50 | ±0.05 | ±0.05 | 0.16% | |
| C1005NP0150 | C1005NP0150 | 1V, 1MHz | 15 | pF | ±5%,±2%,±1% | 0.50 | ±0.05 | ±0.05 | 0.14% | | |
| C1005NP0160 | C1005NP0160 | 1V, 1MHz | 16 | pF | ±5%,±2%,±1% | 0.50 | ±0.05 | ±0.05 | 0.14% | | |
| C1005NP0180 | C1005NP0180 | 1V, 1MHz | 18 | pF | ±5%,±2%,±1% | 0.50 | ±0.05 | ±0.05 | 0.13% | | |
| C1005NP0200 | C1005NP0200 | 1V, 1MHz | 20 | pF | ±5%,±2%,±1% | 0.50 | ±0.05 | ±0.05 | 0.13% | | |
| C1005NP0220 | C1005NP0220 | 1V, 1MHz | 22 | pF | ±5%,±2%,±1% | 0.50 | ±0.05 | ±0.05 | 0.12% | | |
| C1005NP0240 | C1005NP0240 | 1V, 1MHz | 24 | pF | ±5%,±2%,±1% | 0.50 | ±0.05 | ±0.05 | 0.11% | | |
| C1005NP0270 | C1005NP0270 | 1V, 1MHz | 27 | pF | ±5%,±2%,±1% | 0.50 | ±0.05 | ±0.05 | 0.11% | | |
| C1005NP0300 | C1005NP0300 | 1V, 1MHz | 30 | pF | ±5%,±2%,±1% | 0.50 | ±0.05 | ±0.05 | 0.10% | | |
| C1005NP0330 | C1005NP0330 | 1V, 1MHz | 33 | pF | ±10%,±5%,±2%,±1% | 0.50 | ±0.05 | ±0.05 | 0.10% | | |
| C1005NP0360 | C1005NP0360 | 1V, 1MHz | 36 | pF | ±5%,±2%,±1% | 0.50 | ±0.05 | ±0.05 | 0.10% | | |
| C1005NP0390 | C1005NP0390 | 1V, 1MHz | 39 | pF | ±5%,±2%,±1% | 0.50 | ±0.05 | ±0.05 | 0.10% | | |
| C1005NP0430 | C1005NP0430 | 1V, 1MHz | 43 | pF | ±5%,±2%,±1% | 0.50 | ±0.05 | ±0.05 | 0.10% | | |
| C1005NP0470 | C1005NP0470 | 1V, 1MHz | 47 | pF | ±5%,±2%,±1% | 0.50 | ±0.05 | ±0.05 | 0.10% | | |
| C1005NP0510 | C1005NP0510 | 1V, 1MHz | 51 | pF | ±5%,±2%,±1% | 0.50 | ±0.05 | ±0.05 | 0.10% | | |
| C1005NP0560 | C1005NP0560 | 1V, 1MHz | 56 | pF | ±5%,±2%,±1% | 0.50 | ±0.05 | ±0.05 | 0.10% | | |
| C1005NP0620 | C1005NP0620 | 1V, 1MHz | 62 | pF | ±5%,±2%,±1% | 0.50 | ±0.05 | ±0.05 | 0.10% | | |
| C1005NP0680 | C1005NP0680 | 1V, 1MHz | 68 | pF | ±5%,±2%,±1% | 0.50 | ±0.05 | ±0.05 | 0.10% | | |
| C1005NP0750 | C1005NP0750 | 1V, 1MHz | 75 | pF | ±5%,±2%,±1% | 0.50 | ±0.05 | ±0.05 | 0.10% | | |
| C1005NP0820 | C1005NP0820 | 1V, 1MHz | 82 | pF | ±5%,±2%,±1% | 0.50 | ±0.05 | ±0.05 | 0.10% | | |
| C1005NP0910 | C1005NP0910 | 1V, 1MHz | 91 | pF | ±5%,±2%,±1% | 0.50 | ±0.05 | ±0.05 | 0.10% | | |
| C1005NP0101 | C1005NP0101 | 1V, 1MHz | 100 | pF | ±5%,±2%,±1% | 0.50 | ±0.05 | ±0.05 | 0.10% | | |
| C1005NP0121 | C1005NP0121 | 1V, 1MHz | 120 | pF | ±5%,±2%,±1% | 0.50 | ±0.05 | ±0.05 | 0.10% | | |
| C1005NP0151 | C1005NP0151 | 1V, 1MHz | 150 | pF | ±5%,±2%,±1% | 0.50 | ±0.05 | ±0.05 | 0.10% | | |
| C1005NP0181 | C1005NP0181 | 1V, 1MHz | 180 | pF | ±5%,±2%,±1% | 0.50 | ±0.05 | ±0.05 | 0.10% | | |
| C1005NP0201 | C1005NP0201 | 1V, 1MHz | 200 | pF | ±5%,±2%,±1% | 0.50 | ±0.05 | ±0.05 | 0.10% | | |
| C1005NP0221 | C1005NP0221 | 1V, 1MHz | 220 | pF | ±5%,±2%,±1% | 0.50 | ±0.05 | ±0.05 | 0.10% | | |

Paper, 10Kpcs

□ Tolerance Code: A=±0.05 pF, B=±0.1pF, C=±0.25pF, D=±0.5pF, F=±1%, G=±2%, J=±5%; Special tolerance on the request.

| RV | DARFON P/N | DARFON P/N 2 | Measuring Condition | Capacitance | | Available Tolerance | Thick. (mm) | Tolerance(mm) | | DF (max.) | Standard Packing |
|-----|------------------|-----------------|---------------------|-------------|------|------------------------|-------------|---------------|--------|-----------|------------------|
| | | | | Value | Unit | | | L/W | Thick. | | |
| 50V | C1005NP0271□GTS | C1005NP0271□GT | 1V, 1MHz | 270 | pF | ±5%,±2%,±1% | 0.50 | ±0.05 | ±0.05 | 0.10% | Paper, 10Kpcs |
| | C1005NP0301□GTS | C1005NP0301□GT | 1V, 1MHz | 300 | pF | ±5%,±2% | 0.50 | ±0.05 | ±0.05 | 0.10% | |
| | C1005NP0331□GTS | C1005NP0331□GT | 1V, 1MHz | 330 | pF | ±5%,±2% | 0.50 | ±0.05 | ±0.05 | 0.10% | |
| | C1005NP0391□GTS | C1005NP0391□GT | 1V, 1MHz | 390 | pF | ±5%,±2%,±1% | 0.50 | ±0.05 | ±0.05 | 0.10% | |
| | C1005NP0471□GTS | C1005NP0471□GT | 1V, 1MHz | 470 | pF | ±5%,±2% | 0.50 | ±0.05 | ±0.05 | 0.10% | |
| | C1005NP0561□GTS | C1005NP0561□GT | 1V, 1MHz | 560 | pF | ±5%,±2% | 0.50 | ±0.05 | ±0.05 | 0.10% | |
| | C1005NP0681□GTS | C1005NP0681□GT | 1V, 1MHz | 680 | pF | ±5%,±2%,±1% | 0.50 | ±0.05 | ±0.05 | 0.10% | |
| | C1005NP0821□GTS | C1005NP0821□GT | 1V, 1MHz | 820 | pF | ±5%,±2% | 0.50 | ±0.05 | ±0.05 | 0.10% | |
| 25V | C1005NP0102□GTS | C1005NP0102□GT | 1V, 1MHz | 1.0 | nF | ±5%,±2% | 0.50 | ±0.05 | ±0.05 | 0.10% | Paper, 10Kpcs |
| | C1005NP0208□FTS | C1005NP0208□FT | 1V, 1MHz | 0.2 | pF | ±0.25pF,±0.1pF,±0.05pF | 0.50 | ±0.05 | ±0.05 | 0.25% | |
| | C1005NP0308□FTS | C1005NP0308□FT | 1V, 1MHz | 0.3 | pF | ±0.25pF,±0.1pF,±0.05pF | 0.50 | ±0.05 | ±0.05 | 0.25% | |
| | C1005NP0120□FTS | C1005NP0120□FT | 1V, 1MHz | 12 | pF | ±5%,±2%,±1% | 0.50 | ±0.05 | ±0.05 | 0.16% | |
| | C1005NP0221□JFTS | C1005NP0221□JFT | 1V, 1MHz | 220 | pF | ±5% | 0.50 | ±0.05 | ±0.05 | 0.10% | |
| 16V | C1005NP0102□JFTS | C1005NP0102□JFT | 1V, 1MHz | 1.0 | nF | ±5% | 0.50 | ±0.05 | ±0.05 | 0.10% | Paper, 10Kpcs |
| | C1005NP0470□ETS | C1005NP0470□ET | 1V, 1MHz | 47 | pF | ±5%,±2%,±1% | 0.50 | ±0.05 | ±0.05 | 0.10% | |
| 10V | C1005NP0331□ETS | C1005NP0331□ET | 1V, 1MHz | 330 | pF | ±5%,±2% | 0.50 | ±0.05 | ±0.05 | 0.10% | Paper, 10Kpcs |
| | C1005NP0220□DTS | C1005NP0220□DT | 1V, 1MHz | 22 | pF | ±5%,±2%,±1% | 0.50 | ±0.05 | ±0.05 | 0.12% | |

● C1608NP0_S Series (EIA0603)

| RV | DARFON P/N | DARFON P/N 2 | Measuring Condition | Capacitance | | Available Tolerance | Thick. (mm) | Tolerance(mm) | | DF (max.) | Standard Packing |
|-----------------|-----------------|----------------|---------------------|-------------|-------------|------------------------|-------------|---------------|--------|-----------|------------------|
| | | | | Value | Unit | | | L/W | Thick. | | |
| 50V | C1608NP0308□GTS | C1608NP0308□GT | 1V, 1MHz | 0.30 | pF | ±0.25pF,±0.1pF,±0.05pF | 0.80 | ±0.10 | ±0.10 | 0.25% | Paper, 4Kpcs |
| | C1608NP0508□GTS | C1608NP0508□GT | 1V, 1MHz | 0.50 | pF | ±0.25pF,±0.1pF,±0.05pF | 0.80 | ±0.10 | ±0.10 | 0.24% | |
| | C1608NP0758□GTS | C1608NP0758□GT | 1V, 1MHz | 0.75 | pF | ±0.25pF,±0.1pF,±0.05pF | 0.80 | ±0.10 | ±0.10 | 0.24% | |
| | C1608NP0109□GTS | C1608NP0109□GT | 1V, 1MHz | 1.0 | pF | ±0.25pF,±0.1pF | 0.80 | ±0.10 | ±0.10 | 0.24% | |
| | C1608NP0129□GTS | C1608NP0129□GT | 1V, 1MHz | 1.2 | pF | ±0.25pF,±0.1pF | 0.80 | ±0.10 | ±0.10 | 0.24% | |
| | C1608NP0159□GTS | C1608NP0159□GT | 1V, 1MHz | 1.5 | pF | ±0.25pF,±0.1pF | 0.80 | ±0.10 | ±0.10 | 0.23% | |
| | C1608NP0189□GTS | C1608NP0189□GT | 1V, 1MHz | 1.8 | pF | ±0.25pF,±0.1pF | 0.80 | ±0.10 | ±0.10 | 0.23% | |
| | C1608NP0209□GTS | C1608NP0209□GT | 1V, 1MHz | 2.0 | pF | ±0.25pF,±0.1pF | 0.80 | ±0.10 | ±0.10 | 0.23% | |
| | C1608NP0229□GTS | C1608NP0229□GT | 1V, 1MHz | 2.2 | pF | ±0.25pF,±0.1pF | 0.80 | ±0.10 | ±0.10 | 0.23% | |
| | C1608NP0249□GTS | C1608NP0249□GT | 1V, 1MHz | 2.4 | pF | ±0.25pF,±0.1pF | 0.80 | ±0.10 | ±0.10 | 0.22% | |
| | C1608NP0279□GTS | C1608NP0279□GT | 1V, 1MHz | 2.7 | pF | ±0.25pF,±0.1pF | 0.80 | ±0.10 | ±0.10 | 0.22% | |
| | C1608NP0309□GTS | C1608NP0309□GT | 1V, 1MHz | 3.0 | pF | ±0.25pF,±0.1pF | 0.80 | ±0.10 | ±0.10 | 0.22% | |
| | C1608NP0339□GTS | C1608NP0339□GT | 1V, 1MHz | 3.3 | pF | ±0.25pF,±0.1pF | 0.80 | ±0.10 | ±0.10 | 0.21% | |
| | C1608NP0399□GTS | C1608NP0399□GT | 1V, 1MHz | 3.9 | pF | ±0.25pF,±0.1pF | 0.80 | ±0.10 | ±0.10 | 0.21% | |
| | C1608NP0409□GTS | C1608NP0409□GT | 1V, 1MHz | 4.0 | pF | ±0.25pF,±0.1pF | 0.80 | ±0.10 | ±0.10 | 0.21% | |
| | C1608NP0479□GTS | C1608NP0479□GT | 1V, 1MHz | 4.7 | pF | ±0.25pF,±0.1pF | 0.80 | ±0.10 | ±0.10 | 0.20% | |
| | C1608NP0509□GTS | C1608NP0509□GT | 1V, 1MHz | 5.0 | pF | ±0.5pF,±0.25pF,±0.1pF | 0.80 | ±0.10 | ±0.10 | 0.20% | |
| | C1608NP0569□GTS | C1608NP0569□GT | 1V, 1MHz | 5.6 | pF | ±0.5pF,±0.25pF,±0.1pF | 0.80 | ±0.10 | ±0.10 | 0.20% | |
| | C1608NP0609□GTS | C1608NP0609□GT | 1V, 1MHz | 6.0 | pF | ±0.5pF,±0.25pF,±0.1pF | 0.80 | ±0.10 | ±0.10 | 0.19% | |
| | C1608NP0629□GTS | C1608NP0629□GT | 1V, 1MHz | 6.2 | pF | ±0.5pF,±0.25pF,±0.1pF | 0.80 | ±0.10 | ±0.10 | 0.19% | |
| | C1608NP0689□GTS | C1608NP0689□GT | 1V, 1MHz | 6.8 | pF | ±0.5pF,±0.25pF,±0.1pF | 0.80 | ±0.10 | ±0.10 | 0.19% | |
| | C1608NP0709□GTS | C1608NP0709□GT | 1V, 1MHz | 7.0 | pF | ±0.5pF,±0.25pF,±0.1pF | 0.80 | ±0.10 | ±0.10 | 0.19% | |
| | C1608NP0829□GTS | C1608NP0829□GT | 1V, 1MHz | 8.2 | pF | ±0.5pF,±0.25pF,±0.1pF | 0.80 | ±0.10 | ±0.10 | 0.18% | |
| | C1608NP0909□GTS | C1608NP0909□GT | 1V, 1MHz | 9.0 | pF | ±0.5pF,±0.25pF,±0.1pF | 0.80 | ±0.10 | ±0.10 | 0.17% | |
| | C1608NP0100□GTS | C1608NP0100□GT | 1V, 1MHz | 10 | pF | ±5%,±2%,±1% | 0.80 | ±0.10 | ±0.10 | 0.17% | |
| | C1608NP0110□GTS | C1608NP0110□GT | 1V, 1MHz | 11 | pF | ±5%,±2%,±1% | 0.80 | ±0.10 | ±0.10 | 0.16% | |
| | C1608NP0120□GTS | C1608NP0120□GT | 1V, 1MHz | 12 | pF | ±5%,±2%,±1% | 0.80 | ±0.10 | ±0.10 | 0.16% | |
| | C1608NP0150□GTS | C1608NP0150□GT | 1V, 1MHz | 15 | pF | ±5%,±2%,±1% | 0.80 | ±0.10 | ±0.10 | 0.14% | |
| | C1608NP0180□GTS | C1608NP0180□GT | 1V, 1MHz | 18 | pF | ±5%,±2%,±1% | 0.80 | ±0.10 | ±0.10 | 0.13% | |
| | C1608NP0200□GTS | C1608NP0200□GT | 1V, 1MHz | 20 | pF | ±5%,±2%,±1% | 0.80 | ±0.10 | ±0.10 | 0.13% | |
| | C1608NP0220□GTS | C1608NP0220□GT | 1V, 1MHz | 22 | pF | ±5%,±2%,±1% | 0.80 | ±0.10 | ±0.10 | 0.12% | |
| | C1608NP0240□GTS | C1608NP0240□GT | 1V, 1MHz | 24 | pF | ±5%,±2%,±1% | 0.80 | ±0.10 | ±0.10 | 0.11% | |
| | C1608NP0270□GTS | C1608NP0270□GT | 1V, 1MHz | 27 | pF | ±5%,±2%,±1% | 0.80 | ±0.10 | ±0.10 | 0.11% | |
| | C1608NP0300□GTS | C1608NP0300□GT | 1V, 1MHz | 30 | pF | ±5%,±2%,±1% | 0.80 | ±0.10 | ±0.10 | 0.10% | |
| | C1608NP0330□GTS | C1608NP0330□GT | 1V, 1MHz | 33 | pF | ±5%,±2%,±1% | 0.80 | ±0.10 | ±0.10 | 0.10% | |
| | C1608NP0360□GTS | C1608NP0360□GT | 1V, 1MHz | 36 | pF | ±5%,±2%,±1% | 0.80 | ±0.10 | ±0.10 | 0.10% | |
| | C1608NP0390□GTS | C1608NP0390□GT | 1V, 1MHz | 39 | pF | ±5%,±2%,±1% | 0.80 | ±0.10 | ±0.10 | 0.10% | |
| | C1608NP0430□GTS | C1608NP0430□GT | 1V, 1MHz | 43 | pF | ±5%,±2%,±1% | 0.80 | ±0.10 | ±0.10 | 0.10% | |
| | C1608NP0470□GTS | C1608NP0470□GT | 1V, 1MHz | 47 | pF | ±5%,±2%,±1% | 0.80 | ±0.10 | ±0.10 | 0.10% | |
| | C1608NP0560□GTS | C1608NP0560□GT | 1V, 1MHz | 56 | pF | ±5%,±2%,±1% | 0.80 | ±0.10 | ±0.10 | 0.10% | |
| | C1608NP0620□GTS | C1608NP0620□GT | 1V, 1MHz | 62 | pF | ±5%,±2%,±1% | 0.80 | ±0.10 | ±0.10 | 0.10% | |
| | C1608NP0680□GTS | C1608NP0680□GT | 1V, 1MHz | 68 | pF | ±5%,±2%,±1% | 0.80 | ±0.10 | ±0.10 | 0.10% | |
| C1608NP0750□GTS | C1608NP0750□GT | 1V, 1MHz | 75 | pF | ±5%,±2%,±1% | 0.80 | ±0.10 | ±0.10 | 0.10% | | |
| C1608NP0820□GTS | C1608NP0820□GT | 1V, 1MHz | 82 | pF | ±5%,±2%,±1% | 0.80 | ±0.10 | ±0.10 | 0.10% | | |
| C1608NP0910□GTS | C1608NP0910□GT | 1V, 1MHz | 91 | pF | ±5%,±2%,±1% | 0.80 | ±0.10 | ±0.10 | 0.10% | | |
| C1608NP0101□GTS | C1608NP0101□GT | 1V, 1MHz | 100 | pF | ±5%,±2%,±1% | 0.80 | ±0.10 | ±0.10 | 0.10% | | |
| C1608NP0121□GTS | C1608NP0121□GT | 1V, 1MHz | 120 | pF | ±5%,±2%,±1% | 0.80 | ±0.10 | ±0.10 | 0.10% | | |
| C1608NP0151□GTS | C1608NP0151□GT | 1V, 1MHz | 150 | pF | ±5%,±2%,±1% | 0.80 | ±0.10 | ±0.10 | 0.10% | | |
| C1608NP0181□GTS | C1608NP0181□GT | 1V, 1MHz | 180 | pF | ±5%,±2%,±1% | 0.80 | ±0.10 | ±0.10 | 0.10% | | |
| C1608NP0201□GTS | C1608NP0201□GT | 1V, 1MHz | 200 | pF | ±5%,±2%,±1% | 0.80 | ±0.10 | ±0.10 | 0.10% | | |
| C1608NP0221□GTS | C1608NP0221□GT | 1V, 1MHz | 220 | pF | ±5%,±2%,±1% | 0.80 | ±0.10 | ±0.10 | 0.10% | | |

| RV | DARFON P/N | DARFON P/N 2 | Measuring Condition | Capacitance | | Available Tolerance | Thick. (mm) | Tolerance(mm) | | DF (max.) | Standard Packing |
|-----------------|-----------------|----------------|---------------------|-------------|------|---------------------|-------------|---------------|-------------|-----------|------------------|
| | | | | Value | Unit | | | L/W | Thick. | | |
| 50V | C1608NP0271□GTS | C1608NP0271□GT | 1V, 1MHz | 270 | pF | ±5%,±2% | 0.80 | ±0.10 | ±0.10 | 0.10% | Paper, 4Kpcs |
| | C1608NP0331□GTS | C1608NP0331□GT | 1V, 1MHz | 330 | pF | ±5%,±2% | 0.80 | ±0.10 | ±0.10 | 0.10% | |
| | C1608NP0391□GTS | C1608NP0391□GT | 1V, 1MHz | 390 | pF | ±5%,±2% | 0.80 | ±0.10 | ±0.10 | 0.10% | |
| | C1608NP0471□GTS | C1608NP0471□GT | 1V, 1MHz | 470 | pF | ±5%,±2% | 0.80 | ±0.10 | ±0.10 | 0.10% | |
| | C1608NP0561□GTS | C1608NP0561□GT | 1V, 1MHz | 560 | pF | ±5%,±2% | 0.80 | ±0.10 | ±0.10 | 0.10% | |
| | C1608NP0681□GTS | C1608NP0681□GT | 1V, 1MHz | 680 | pF | ±5%,±2% | 0.80 | ±0.10 | ±0.10 | 0.10% | |
| | C1608NP0821□GTS | C1608NP0821□GT | 1V, 1MHz | 820 | pF | ±5%,±2% | 0.80 | ±0.10 | ±0.10 | 0.10% | |
| | C1608NP0102□GTS | C1608NP0102□GT | 1V, 1MHz | 1.0 | nF | ±5%,±2% | 0.80 | ±0.10 | ±0.10 | 0.10% | |
| | C1608NP0122JGTS | C1608NP0122JGT | 1V, 1kHz | 1.2 | nF | ±5% | 0.80 | +0.15/-0.10 | +0.15/-0.10 | 0.10% | |
| | C1608NP0152JGTS | C1608NP0152JGT | 1V, 1kHz | 1.5 | nF | ±5% | 0.80 | +0.15/-0.10 | +0.15/-0.10 | 0.10% | |
| | C1608NP0182JGTS | C1608NP0182JGT | 1V, 1kHz | 1.8 | nF | ±5% | 0.80 | +0.15/-0.10 | +0.15/-0.10 | 0.10% | |
| | C1608NP0222JGTS | C1608NP0222JGT | 1V, 1kHz | 2.2 | nF | ±5% | 0.80 | +0.15/-0.10 | +0.15/-0.10 | 0.10% | |
| C1608NP0272JGTS | C1608NP0272JGT | 1V, 1kHz | 2.7 | nF | ±5% | 0.80 | +0.15/-0.10 | +0.15/-0.10 | 0.10% | | |
| C1608NP0332JGTS | C1608NP0332JGT | 1V, 1kHz | 3.3 | nF | ±5% | 0.80 | +0.15/-0.10 | +0.15/-0.10 | 0.10% | | |
| C1608NP0103JGTS | C1608NP0103JGT | 1V, 1kHz | 10 | nF | ±5% | 0.80 | +0.15/-0.10 | +0.15/-0.10 | 0.10% | | |
| 25V | C1608NP0152JFTS | C1608NP0152JFT | 1V, 1kHz | 1.5 | nF | ±5% | 0.80 | +0.15/-0.10 | +0.15/-0.10 | 0.10% | Paper, 4Kpcs |
| | C1608NP0682JFTS | C1608NP0682JFT | 1V, 1kHz | 6.8 | nF | ±5% | 0.80 | +0.15/-0.10 | +0.15/-0.10 | 0.10% | |
| | C1608NP0103JFTS | C1608NP0103JFT | 1V, 1kHz | 10 | nF | ±5% | 0.80 | +0.15/-0.10 | +0.15/-0.10 | 0.10% | |
| 16V | C1608NP0180□ETS | C1608NP0180□ET | 1V, 1MHz | 18 | pF | ±5%,±2%,±1% | 0.80 | ±0.10 | ±0.10 | 0.13% | Paper, 4Kpcs |
| | C1608NP0300JETS | C1608NP0300JET | 1V, 1MHz | 30 | pF | ±5% | 0.80 | ±0.10 | ±0.10 | 0.10% | |
| | C1608NP0152JETS | C1608NP0152JET | 1V, 1kHz | 1.5 | nF | ±5% | 0.80 | +0.15/-0.10 | +0.15/-0.10 | 0.10% | |
| | C1608NP0272JETS | C1608NP0272JET | 1V, 1kHz | 2.7 | nF | ±5% | 0.80 | +0.15/-0.10 | +0.15/-0.10 | 0.10% | |
| C1608NP0332JETS | C1608NP0332JET | 1V, 1kHz | 3.3 | nF | ±5% | 0.80 | +0.15/-0.10 | +0.15/-0.10 | 0.10% | | |

● C2012NP0_S Series (EIA0805)

| RV | DARFON P/N | DARFON P/N 2 | Measuring Condition | Capacitance | | Available Tolerance | Thick. (mm) | Tolerance(mm) | | DF (max.) | Standard Packing |
|-----------------|-----------------|----------------|---------------------|-------------|------|---------------------|-------------|---------------|--------|-----------|------------------|
| | | | | Value | Unit | | | L/W | Thick. | | |
| 50V | C2012NP0100□GTS | C2012NP0100□GT | 1V, 1MHz | 10 | pF | ±5%,±2% | 0.60 | ±0.15 | ±0.15 | 0.17% | Paper, 4Kpcs |
| | C2012NP0120□GTS | C2012NP0120□GT | 1V, 1MHz | 12 | pF | ±5%,±2% | 0.60 | ±0.15 | ±0.15 | 0.16% | |
| | C2012NP0150□GTS | C2012NP0150□GT | 1V, 1MHz | 15 | pF | ±5%,±2% | 0.60 | ±0.15 | ±0.15 | 0.14% | |
| | C2012NP0180□GTS | C2012NP0180□GT | 1V, 1MHz | 18 | pF | ±5%,±2% | 0.60 | ±0.15 | ±0.15 | 0.13% | |
| | C2012NP0200□GTS | C2012NP0200□GT | 1V, 1MHz | 20 | pF | ±5%,±2% | 0.60 | ±0.15 | ±0.15 | 0.13% | |
| | C2012NP0220□GTS | C2012NP0220□GT | 1V, 1MHz | 22 | pF | ±5%,±2% | 0.60 | ±0.15 | ±0.15 | 0.12% | |
| | C2012NP0270□GTS | C2012NP0270□GT | 1V, 1MHz | 27 | pF | ±5%,±2% | 0.60 | ±0.15 | ±0.15 | 0.11% | |
| | C2012NP0300□GTS | C2012NP0300□GT | 1V, 1MHz | 30 | pF | ±5%,±2% | 0.60 | ±0.15 | ±0.15 | 0.10% | |
| | C2012NP0330□GTS | C2012NP0330□GT | 1V, 1MHz | 33 | pF | ±5%,±2% | 0.60 | ±0.15 | ±0.15 | 0.10% | |
| | C2012NP0360□GTS | C2012NP0360□GT | 1V, 1MHz | 36 | pF | ±5%,±2% | 0.60 | ±0.15 | ±0.15 | 0.10% | |
| | C2012NP0470□GTS | C2012NP0470□GT | 1V, 1MHz | 47 | pF | ±5%,±2% | 0.60 | ±0.15 | ±0.15 | 0.10% | |
| | C2012NP0680□GTS | C2012NP0680□GT | 1V, 1MHz | 68 | pF | ±5%,±2% | 0.60 | ±0.15 | ±0.15 | 0.10% | |
| | C2012NP0820□GTS | C2012NP0820□GT | 1V, 1MHz | 82 | pF | ±5%,±2% | 0.60 | ±0.15 | ±0.15 | 0.10% | |
| | C2012NP0101□GTS | C2012NP0101□GT | 1V, 1MHz | 100 | pF | ±5%,±2% | 0.60 | ±0.15 | ±0.15 | 0.10% | |
| | C2012NP0121JGTS | C2012NP0121JGT | 1V, 1MHz | 120 | pF | ±5% | 0.60 | ±0.15 | ±0.15 | 0.10% | |
| | C2012NP0151JGTS | C2012NP0151JGT | 1V, 1MHz | 150 | pF | ±5% | 0.60 | ±0.15 | ±0.15 | 0.10% | |
| | C2012NP0201JGTS | C2012NP0201JGT | 1V, 1MHz | 200 | pF | ±5% | 0.60 | ±0.15 | ±0.15 | 0.10% | |
| | C2012NP0221JGTS | C2012NP0221JGT | 1V, 1MHz | 220 | pF | ±5% | 0.60 | ±0.15 | ±0.15 | 0.10% | |
| | C2012NP0271JGTS | C2012NP0271JGT | 1V, 1MHz | 270 | pF | ±5% | 0.60 | ±0.15 | ±0.15 | 0.10% | |
| | C2012NP0331JGTS | C2012NP0331JGT | 1V, 1MHz | 330 | pF | ±5% | 0.60 | ±0.15 | ±0.15 | 0.10% | |
| | C2012NP0391JGTS | C2012NP0391JGT | 1V, 1MHz | 390 | pF | ±5% | 0.60 | ±0.15 | ±0.15 | 0.10% | |
| | C2012NP0471JGTS | C2012NP0471JGT | 1V, 1MHz | 470 | pF | ±5% | 0.60 | ±0.15 | ±0.15 | 0.10% | |
| | C2012NP0561JGTS | C2012NP0561JGT | 1V, 1MHz | 560 | pF | ±5% | 0.60 | ±0.15 | ±0.15 | 0.10% | |
| | C2012NP0681JGTS | C2012NP0681JGT | 1V, 1MHz | 680 | pF | ±5% | 0.60 | ±0.15 | ±0.15 | 0.10% | |
| | C2012NP0821JGTS | C2012NP0821JGT | 1V, 1MHz | 820 | pF | ±5% | 0.60 | ±0.15 | ±0.15 | 0.10% | |
| | C2012NP0102JGTS | C2012NP0102JGT | 1V, 1MHz | 1.0 | nF | ±5% | 0.60 | ±0.15 | ±0.15 | 0.10% | |
| | C2012NP0122JGTS | C2012NP0122JGT | 1V, 1kHz | 1.2 | nF | ±5% | 0.85 | ±0.15 | ±0.15 | 0.10% | |
| | C2012NP0152JGTS | C2012NP0152JGT | 1V, 1kHz | 1.5 | nF | ±5% | 0.85 | ±0.15 | ±0.15 | 0.10% | |
| | C2012NP0182JGTS | C2012NP0182JGT | 1V, 1kHz | 1.8 | nF | ±5% | 0.85 | ±0.15 | ±0.15 | 0.10% | |
| | C2012NP0222JGTS | C2012NP0222JGT | 1V, 1kHz | 2.2 | nF | ±5% | 0.85 | ±0.15 | ±0.15 | 0.10% | |
| | C2012NP0272JGTS | C2012NP0272JGT | 1V, 1kHz | 2.7 | nF | ±5% | 0.85 | ±0.15 | ±0.15 | 0.10% | |
| | C2012NP0332JGTS | C2012NP0332JGT | 1V, 1kHz | 3.3 | nF | ±5% | 0.85 | ±0.15 | ±0.15 | 0.10% | |
| | C2012NP0392JGTS | C2012NP0392JGT | 1V, 1kHz | 3.9 | nF | ±5% | 0.85 | ±0.15 | ±0.15 | 0.10% | |
| | C2012NP0472JGTS | C2012NP0472JGT | 1V, 1kHz | 4.7 | nF | ±5% | 0.85 | ±0.15 | ±0.15 | 0.10% | |
| | C2012NP0272JGPS | C2012NP0272JGP | 1V, 1kHz | 2.7 | nF | ±5% | 1.25 | ±0.15 | ±0.20 | 0.10% | |
| | C2012NP0332JGPS | C2012NP0332JGP | 1V, 1kHz | 3.3 | nF | ±5% | 1.25 | ±0.15 | ±0.20 | 0.10% | |
| | C2012NP0392JGPS | C2012NP0392JGP | 1V, 1kHz | 3.9 | nF | ±5% | 1.25 | ±0.15 | ±0.20 | 0.10% | |
| | C2012NP0472JGPS | C2012NP0472JGP | 1V, 1kHz | 4.7 | nF | ±5% | 1.25 | ±0.15 | ±0.20 | 0.10% | |
| | C2012NP0562JGPS | C2012NP0562JGP | 1V, 1kHz | 5.6 | nF | ±5% | 1.25 | ±0.15 | ±0.20 | 0.10% | |
| | C2012NP0682JGPS | C2012NP0682JGP | 1V, 1kHz | 6.8 | nF | ±5% | 1.25 | ±0.15 | ±0.20 | 0.10% | |
| | C2012NP0822JGPS | C2012NP0822JGP | 1V, 1kHz | 8.2 | nF | ±5% | 1.25 | ±0.15 | ±0.20 | 0.10% | |
| | C2012NP0103JGTS | C2012NP0103JGT | 1V, 1kHz | 10 | nF | ±5% | 0.85 | ±0.15 | ±0.10 | 0.10% | |
| C2012NP0103JGPS | C2012NP0103JGP | 1V, 1kHz | 10 | nF | ±5% | 1.25 | ±0.15 | ±0.20 | 0.10% | | |
| 16V | C2012NP0270□ETS | C2012NP0270□GT | 1V, 1MHz | 27 | pF | ±5%,±2% | 0.60 | ±0.15 | ±0.15 | 0.11% | Paper, 4Kpcs |

□ Tolerance Code: F=±1%, G=±2%, J=±5%; Special tolerance on the request.

● C3216NP0_S Series (EIA1206)

| RV | DARFON P/N | DARFON P/N 2 | Measuring Condition | Capacitance | | Available Tolerance | Thick. (mm) | Tolerance(mm) | | DF (max.) | Standard Packing |
|-----------------|-----------------|----------------|---------------------|-------------|------|---------------------|-------------|---------------|--------|-----------------|------------------|
| | | | | Value | Unit | | | L/W | Thick. | | |
| 50V | C3216NP0103JGPS | C3216NP0103JGP | 1V, 1kHz | 10 | nF | ±5% | 1.25 | ±0.15 | ±0.20 | 0.10% | Embossed, 3Kpcs |
| | C3216NP0123JGPS | C3216NP0123JGP | 1V, 1kHz | 12 | nF | ±5% | 1.60 | ±0.30 | ±0.30 | 0.10% | |
| | C3216NP0153JGPS | C3216NP0153JGP | 1V, 1kHz | 15 | nF | ±5% | 1.60 | ±0.30 | ±0.30 | 0.10% | |
| | C3216NP0183JGPS | C3216NP0183JGP | 1V, 1kHz | 18 | nF | ±5% | 1.60 | ±0.30 | ±0.30 | 0.10% | Embossed, 2Kpcs |
| | C3216NP0223JGPS | C3216NP0223JGP | 1V, 1kHz | 22 | nF | ±5% | 1.60 | ±0.30 | ±0.30 | 0.10% | |
| | C3216NP0273JGPS | C3216NP0273JGP | 1V, 1kHz | 27 | nF | ±5% | 1.60 | ±0.30 | ±0.30 | 0.10% | |
| | C3216NP0333JGPS | C3216NP0333JGP | 1V, 1kHz | 33 | nF | ±5% | 1.60 | ±0.30 | ±0.30 | 0.10% | |
| | C3216NP0393JGPS | C3216NP0393JGP | 1V, 1kHz | 39 | nF | ±5% | 1.60 | ±0.30 | ±0.30 | 0.10% | |
| | C3216NP0473JGPS | C3216NP0473JGP | 1V, 1kHz | 47 | nF | ±5% | 1.15 | ±0.20 | ±0.20 | 0.10% | |
| C3216NP0104JGPS | C3216NP0104JGP | 1V, 1kHz | 100 | nF | ±5% | 1.60 | ±0.30 | ±0.30 | 0.10% | Embossed, 2Kpcs | |
| 16V | C3216NP0123JEPS | C3216NP0123JEP | 1V, 1kHz | 12 | nF | ±5% | 1.60 | ±0.30 | ±0.30 | 0.10% | Embossed, 2Kpcs |
| | C3216NP0153JEPS | C3216NP0153JEP | 1V, 1kHz | 15 | nF | ±5% | 1.60 | ±0.30 | ±0.30 | 0.10% | |
| | C3216NP0183JEPS | C3216NP0183JEP | 1V, 1kHz | 18 | nF | ±5% | 1.60 | ±0.30 | ±0.30 | 0.10% | |
| | C3216NP0223JEPS | C3216NP0223JEP | 1V, 1kHz | 22 | nF | ±5% | 1.60 | ±0.30 | ±0.30 | 0.10% | |
| | C3216NP0273JEPS | C3216NP0273JEP | 1V, 1kHz | 27 | nF | ±5% | 1.60 | ±0.30 | ±0.30 | 0.10% | |
| | C3216NP0333JEPS | C3216NP0333JEP | 1V, 1kHz | 33 | nF | ±5% | 1.60 | ±0.30 | ±0.30 | 0.10% | |
| | C3216NP0393JEPS | C3216NP0393JEP | 1V, 1kHz | 39 | nF | ±5% | 1.60 | ±0.30 | ±0.30 | 0.10% | |

□ Tolerance Code: F=±1%, G=±2%, J=±5%; Special tolerance on the request.

● Class II: High Dielectric Constant Type

■ Feature

1. High volumetric efficiency
2. High insulation resistance
3. RoHS compliant
4. Halogen Free

■ Application

1. Blocking
2. Coupling
3. Timing
4. Bypassing
5. Frequency discriminating
6. Flittering

■ Part Number & Characteristic

■ X5R Series

● C0603X5R Series(EIA0201)

| RV | DARFON P/N | DARFON P/N 2 | Measuring Condition | Capacitance | | Available Tolerance | Thick. (mm) | Tolerance(mm) | | DF (max.) | Standard Packing | Test Spec. |
|-----------------|-----------------|----------------|---------------------|-------------|------|---------------------|-------------|---------------|--------|-----------|------------------|------------|
| | | | | Value | Unit | | | L/W | Thick. | | | |
| 50V | C0603X5R102□GTS | C0603X5R102□GT | 1V, 1kHz | 1.0 | nF | ±10%, ±20% | 0.30 | ±0.03 | ±0.03 | 5.0% | Paper, 15Kpcs | (I) |
| | C0603X5R151KFTS | C0603X5R151KFT | 1V, 1kHz | 150 | pF | ±10% | 0.30 | ±0.03 | ±0.03 | 5.0% | Paper, 15Kpcs | (I) |
| | C0603X5R102□FTS | C0603X5R102□FT | 1V, 1kHz | 1.0 | nF | ±10%, ±20% | 0.30 | ±0.03 | ±0.03 | 5.0% | | (I) |
| | C0603X5R103□FTS | C0603X5R103□FT | 1V, 1kHz | 10 | nF | ±10%, ±20% | 0.30 | ±0.03 | ±0.03 | 5.0% | | (II)* |
| | C0603X5R223□FTS | C0603X5R223□FT | 1V, 1kHz | 22 | nF | ±10%, ±20% | 0.30 | ±0.03 | ±0.03 | 7.5% | | (II)* |
| | C0603X5R104□FTS | C0603X5R104□FT | 1V, 1kHz | 100 | nF | ±10%, ±20% | 0.30 | ±0.03 | ±0.03 | 10.0% | | (II) |
| C0603X5R474MFTS | C0603X5R474MFT | 1V, 1kHz | 470 | nF | ±20% | 0.30 | ±0.09 | ±0.09 | 10.0% | (II)* | | |
| 16V | C0603X5R103□ETS | C0603X5R103□ET | 1V, 1kHz | 10 | nF | ±10%, ±20% | 0.30 | ±0.03 | ±0.03 | 5.0% | Paper, 15Kpcs | (II) |
| | C0603X5R223□ETS | C0603X5R223□ET | 1V, 1kHz | 22 | nF | ±10%, ±20% | 0.30 | ±0.03 | ±0.03 | 10.0% | | (II)* |
| | C0603X5R473□ETS | C0603X5R473□ET | 1V, 1kHz | 47 | nF | ±10%, ±20% | 0.30 | ±0.03 | ±0.03 | 10.0% | | (II) |
| | C0603X5R104□ETS | C0603X5R104□ET | 1V, 1kHz | 100 | nF | ±10%, ±20% | 0.30 | ±0.03 | ±0.03 | 10.0% | | (II) |
| | C0603X5R224□ETS | C0603X5R224□ET | 1V, 1kHz | 220 | nF | ±10%, ±20% | 0.30 | ±0.03 | ±0.03 | 10.0% | | (II) |
| | C0603X5R105METS | C0603X5R105MET | 0.5V, 1kHz | 1.0 | uF | ±20% | 0.30 | ±0.09 | ±0.09 | 12.5% | | (II)* |
| 10V | C0603X5R222□DTS | C0603X5R222□DT | 1V, 1kHz | 2.2 | nF | ±10%, ±20% | 0.30 | ±0.03 | ±0.03 | 7.5% | Paper, 15Kpcs | (I) |
| | C0603X5R332□DTS | C0603X5R332□DT | 1V, 1kHz | 3.3 | nF | ±10%, ±20% | 0.30 | ±0.03 | ±0.03 | 7.5% | | (I) |
| | C0603X5R472□DTS | C0603X5R472□DT | 1V, 1kHz | 4.7 | nF | ±10%, ±20% | 0.30 | ±0.03 | ±0.03 | 7.5% | | (I) |
| | C0603X5R562□DTS | C0603X5R562□DT | 1V, 1kHz | 5.6 | nF | ±10%, ±20% | 0.30 | ±0.03 | ±0.03 | 7.5% | | (I) |
| | C0603X5R682□DTS | C0603X5R682□DT | 1V, 1kHz | 6.8 | nF | ±10%, ±20% | 0.30 | ±0.03 | ±0.03 | 7.5% | | (I) |
| | C0603X5R822□DTS | C0603X5R822□DT | 1V, 1kHz | 8.2 | nF | ±10%, ±20% | 0.30 | ±0.03 | ±0.03 | 7.5% | | (I) |
| | C0603X5R103□DTS | C0603X5R103□DT | 1V, 1kHz | 10 | nF | ±10%, ±20% | 0.30 | ±0.03 | ±0.03 | 7.5% | | (I) |
| | C0603X5R153□DTS | C0603X5R153□DT | 1V, 1kHz | 15 | nF | ±10%, ±20% | 0.30 | ±0.03 | ±0.03 | 7.5% | | (II) |
| | C0603X5R223□DTS | C0603X5R223□DT | 1V, 1kHz | 22 | nF | ±10%, ±20% | 0.30 | ±0.03 | ±0.03 | 10.0% | | (II) |
| | C0603X5R333□DTS | C0603X5R333□DT | 1V, 1kHz | 33 | nF | ±10%, ±20% | 0.30 | ±0.03 | ±0.03 | 10.0% | | (II) |
| | C0603X5R473□DTS | C0603X5R473□DT | 1V, 1kHz | 47 | nF | ±10%, ±20% | 0.30 | ±0.03 | ±0.03 | 10.0% | | (II) |
| | C0603X5R563□DTS | C0603X5R563□DT | 1V, 1kHz | 56 | nF | ±10%, ±20% | 0.30 | ±0.03 | ±0.03 | 10.0% | | (II) |
| | C0603X5R683□DTS | C0603X5R683□DT | 1V, 1kHz | 68 | nF | ±10%, ±20% | 0.30 | ±0.03 | ±0.03 | 10.0% | | (II) |
| | C0603X5R823□DTS | C0603X5R823□DT | 1V, 1kHz | 82 | nF | ±10%, ±20% | 0.30 | ±0.03 | ±0.03 | 10.0% | | (II) |
| | C0603X5R104□DTS | C0603X5R104□DT | 0.5V, 1kHz | 100 | nF | ±10%, ±20% | 0.30 | ±0.03 | ±0.03 | 10.0% | | (II) |
| | C0603X5R224□DTS | C0603X5R224□DT | 0.5V, 1kHz | 220 | nF | ±10%, ±20% | 0.30 | ±0.03 | ±0.03 | 10.0% | | (II)* |
| | C0603X5R474□DTS | C0603X5R474□DT | 0.5V, 1kHz | 470 | nF | ±10%, ±20% | 0.30 | ±0.03 | ±0.03 | 12.5% | | (II)* |
| | C0603X5R105MDTS | C0603X5R105MDT | 0.5V, 1kHz | 1.0 | uF | ±20% | 0.30 | ±0.09 | ±0.09 | 12.5% | | (II)* |
| 6.3V | C0603X5R222□CTS | C0603X5R222□CT | 1V, 1kHz | 2.2 | nF | ±10%, ±20% | 0.30 | ±0.03 | ±0.03 | 10.0% | Paper, 15Kpcs | (I) |
| | C0603X5R332□CTS | C0603X5R332□CT | 1V, 1kHz | 3.3 | nF | ±10%, ±20% | 0.30 | ±0.03 | ±0.03 | 10.0% | | (I) |
| | C0603X5R472□CTS | C0603X5R472□CT | 1V, 1kHz | 4.7 | nF | ±10%, ±20% | 0.30 | ±0.03 | ±0.03 | 10.0% | | (I) |
| | C0603X5R562□CTS | C0603X5R562□CT | 1V, 1kHz | 5.6 | nF | ±10%, ±20% | 0.30 | ±0.03 | ±0.03 | 10.0% | | (I) |
| | C0603X5R682□CTS | C0603X5R682□CT | 1V, 1kHz | 6.8 | nF | ±10%, ±20% | 0.30 | ±0.03 | ±0.03 | 10.0% | | (I) |
| | C0603X5R822□CTS | C0603X5R822□CT | 1V, 1kHz | 8.2 | nF | ±10%, ±20% | 0.30 | ±0.03 | ±0.03 | 10.0% | | (I) |
| | C0603X5R103□CTS | C0603X5R103□CT | 1V, 1kHz | 10 | nF | ±10%, ±20% | 0.30 | ±0.03 | ±0.03 | 10.0% | | (I) |
| | C0603X5R223□CTS | C0603X5R223□CT | 1V, 1kHz | 22 | nF | ±10%, ±20% | 0.30 | ±0.03 | ±0.03 | 10.0% | | (II) |
| | C0603X5R333□CTS | C0603X5R333□CT | 1V, 1kHz | 33 | nF | ±10%, ±20% | 0.30 | ±0.03 | ±0.03 | 10.0% | | (II) |
| | C0603X5R473□CTS | C0603X5R473□CT | 1V, 1kHz | 47 | nF | ±10%, ±20% | 0.30 | ±0.03 | ±0.03 | 10.0% | | (II) |
| | C0603X5R563□CTS | C0603X5R563□CT | 1V, 1kHz | 56 | nF | ±10%, ±20% | 0.30 | ±0.03 | ±0.03 | 10.0% | | (II) |
| | C0603X5R683□CTS | C0603X5R683□CT | 1V, 1kHz | 68 | nF | ±10%, ±20% | 0.30 | ±0.03 | ±0.03 | 10.0% | | (II) |
| | C0603X5R823□CTS | C0603X5R823□CT | 1V, 1kHz | 82 | nF | ±10%, ±20% | 0.30 | ±0.03 | ±0.03 | 10.0% | | (II) |
| | C0603X5R104□CTS | C0603X5R104□CT | 0.5V, 1kHz | 100 | nF | ±10%, ±20% | 0.30 | ±0.03 | ±0.03 | 10.0% | | (II) |
| | C0603X5R224□CTS | C0603X5R224□CT | 0.5V, 1kHz | 220 | nF | ±10%, ±20% | 0.30 | ±0.03 | ±0.03 | 10.0% | | (II)* |
| | C0603X5R334□CTS | C0603X5R334□CT | 0.5V, 1kHz | 330 | nF | ±10%, ±20% | 0.30 | ±0.03 | ±0.03 | 10.0% | | (II)* |
| | C0603X5R474□CTS | C0603X5R474□CT | 0.5V, 1kHz | 470 | nF | ±10%, ±20% | 0.30 | ±0.03 | ±0.03 | 12.5% | | (II)* |
| | C0603X5R105□CTS | C0603X5R105□CT | 0.5V, 1kHz | 1.0 | uF | ±10%, ±20% | 0.30 | ±0.05 | ±0.05 | 12.5% | | (II)* |
| C0603X5R225MCTS | C0603X5R225MCT | 0.5V, 1kHz | 2.2 | uF | ±20% | 0.30 | ±0.09 | ±0.09 | 20.0% | (II)* | | |
| 4V | C0603X5R224□BTS | C0603X5R224□BT | 0.5V, 1kHz | 220 | nF | ±10%, ±20% | 0.30 | ±0.03 | ±0.03 | 10.0% | Paper, 15Kpcs | (II) |
| | C0603X5R474□BTS | C0603X5R474□BT | 0.5V, 1kHz | 470 | nF | ±10%, ±20% | 0.30 | ±0.03 | ±0.03 | 12.5% | | (II)* |
| | C0603X5R105□BTS | C0603X5R105□BT | 0.5V, 1kHz | 1.0 | uF | ±10%, ±20% | 0.30 | ±0.05 | ±0.05 | 10.0% | | (II)* |

● C1005X5R Series (EIA0402)

| RV | DARFON P/N | DARFON P/N 2 | Measuring Condition | Capacitance | | Available Tolerance | Thick. (mm) | Tolerance(mm) | | DF (max.) | Standard Packing | Test Spec. |
|-----------------|------------------|----------------|---------------------|-------------|------|---------------------|-------------|---------------|--------|-----------|------------------|------------|
| | | | | Value | Unit | | | L/W | Thick. | | | |
| 50V | C1005X5R103KGTS | C1005X5R103KGT | 1V, 1kHz | 10 | nF | ±10% | 0.50 | ±0.05 | ±0.05 | 5.0% | Paper, 10Kpcs | (I) |
| | C1005X5R473KGTS | C1005X5R473KGT | 1V, 1kHz | 47 | nF | ±10% | 0.50 | ±0.05 | ±0.05 | 5.0% | | (I) |
| | C1005X5R104□GTS | C1005X5R104□GT | 1V, 1kHz | 100 | nF | ±10%, ±20% | 0.50 | ±0.05 | ±0.05 | 10.0% | | (II) |
| | C1005X5R474□GTS | C1005X5R474□GT | 1V, 1kHz | 470 | nF | ±10%, ±20% | 0.50 | ±0.10 | ±0.10 | 10.0% | | (II) |
| | C1005X5R105KGTS | C1005X5R105KGT | 1V, 1kHz | 1 | uF | ±10% | 0.50 | ±0.20 | ±0.20 | 10.0% | | (II) |
| 35V | C1005X5R105□NTS | C1005X5R105□NT | 1V, 1kHz | 1.0 | uF | ±10%, ±20% | 0.50 | ±0.10 | ±0.10 | 10.0% | Paper, 10Kpcs | (III)* |
| | C1005X5R225KNTS | C1005X5R225KNT | 1V, 1kHz | 2.2 | uF | ±10% | 0.50 | ±0.10 | ±0.10 | 10.0% | | (III)* |
| 25V | C1005X5R103KFTS | C1005X5R103KFT | 1V, 1kHz | 10 | nF | ±10% | 0.50 | ±0.05 | ±0.05 | 5.0% | Paper, 10Kpcs | (I) |
| | C1005X5R223KFTS | C1005X5R223KFT | 1V, 1kHz | 22 | nF | ±10% | 0.50 | ±0.05 | ±0.05 | 5.0% | | (I) |
| | C1005X5R473KFTS | C1005X5R473KFT | 1V, 1kHz | 47 | nF | ±10% | 0.50 | ±0.05 | ±0.05 | 5.0% | | (I) |
| | C1005X5R683KFTS | C1005X5R683KFT | 1V, 1kHz | 68 | nF | ±10% | 0.50 | ±0.05 | ±0.05 | 5.0% | | (I) |
| | C1005X5R104□FTS | C1005X5R104□FT | 1V, 1kHz | 100 | nF | ±10%, ±20% | 0.50 | ±0.05 | ±0.05 | 5.0% | | (I) |
| | C1005X5R224□FTS | C1005X5R224□FT | 1V, 1kHz | 220 | nF | ±10%, ±20% | 0.50 | ±0.05 | ±0.05 | 10.0% | | (II) |
| | C1005X5R474□FTS | C1005X5R474□FT | 1V, 1kHz | 470 | nF | ±10%, ±20% | 0.50 | ±0.05 | ±0.05 | 12.5% | | (II) |
| | C1005X5R105□FTS | C1005X5R105□FT | 1V, 1kHz | 1.0 | uF | ±10%, ±20% | 0.50 | ±0.10 | ±0.10 | 12.5% | | (III)* |
| | C1005X5R225□FTS | C1005X5R225□FT | 1V, 1kHz | 2.2 | uF | ±10%, ±20% | 0.50 | ±0.20 | ±0.20 | 10.0% | | (II) |
| 16V | C1005X5R153□ETS | C1005X5R153□ET | 1V, 1kHz | 15 | nF | ±10%, ±20% | 0.50 | ±0.05 | ±0.05 | 5.0% | Paper, 10Kpcs | (I) |
| | C1005X5R223□ETS | C1005X5R223□ET | 1V, 1kHz | 22 | nF | ±10%, ±20% | 0.50 | ±0.05 | ±0.05 | 5.0% | | (I) |
| | C1005X5R333□ETS | C1005X5R333□ET | 1V, 1kHz | 33 | nF | ±10%, ±20% | 0.50 | ±0.05 | ±0.05 | 5.0% | | (I) |
| | C1005X5R473□ETS | C1005X5R473□ET | 1V, 1kHz | 47 | nF | ±10%, ±20% | 0.50 | ±0.05 | ±0.05 | 5.0% | | (I) |
| | C1005X5R563□ETS | C1005X5R563□ET | 1V, 1kHz | 56 | nF | ±10%, ±20% | 0.50 | ±0.05 | ±0.05 | 5.0% | | (I) |
| | C1005X5R683□ETS | C1005X5R683□ET | 1V, 1kHz | 68 | nF | ±10%, ±20% | 0.50 | ±0.05 | ±0.05 | 5.0% | | (I) |
| | C1005X5R823□ETS | C1005X5R823□ET | 1V, 1kHz | 82 | nF | ±10%, ±20% | 0.50 | ±0.05 | ±0.05 | 5.0% | | (I) |
| | C1005X5R104□ETS | C1005X5R104□ET | 1V, 1kHz | 100 | nF | ±10%, ±20% | 0.50 | ±0.05 | ±0.05 | 5.0% | | (I) |
| | C1005X5R124□ETS | C1005X5R124□ET | 1V, 1kHz | 120 | nF | ±10%, ±20% | 0.50 | ±0.05 | ±0.05 | 7.5% | | (II) |
| | C1005X5R154□ETS | C1005X5R154□ET | 1V, 1kHz | 150 | nF | ±10%, ±20% | 0.50 | ±0.05 | ±0.05 | 7.5% | | (II) |
| | C1005X5R184□ETS | C1005X5R184□ET | 1V, 1kHz | 180 | nF | ±10%, ±20% | 0.50 | ±0.05 | ±0.05 | 7.5% | | (II) |
| | C1005X5R224□ETS | C1005X5R224□ET | 1V, 1kHz | 220 | nF | ±10%, ±20% | 0.50 | ±0.05 | ±0.05 | 10.0% | | (II) |
| | C1005X5R684□ETS | C1005X5R684□ET | 1V, 1kHz | 680 | nF | ±10%, ±20% | 0.50 | ±0.05 | ±0.05 | 12.5% | | (II) |
| | C1005X5R105□ETS | C1005X5R105□ET | 1V, 1kHz | 1.0 | uF | ±10%, ±20% | 0.50 | ±0.05 | ±0.05 | 12.5% | | (II) |
| | C1005X5R225□ETS | C1005X5R225□ET | 1V, 1kHz | 2.2 | uF | ±10%, ±20% | 0.50 | ±0.10 | ±0.10 | 12.5% | | (III)* |
| 10V | C1005X5R153□DTS | C1005X5R153□DT | 1V, 1kHz | 15 | nF | ±10%, ±20% | 0.50 | ±0.05 | ±0.05 | 7.5% | Paper, 10Kpcs | (I) |
| | C1005X5R223□DTS | C1005X5R223□DT | 1V, 1kHz | 22 | nF | ±10%, ±20% | 0.50 | ±0.05 | ±0.05 | 7.5% | | (I) |
| | C1005X5R333□DTS | C1005X5R333□DT | 1V, 1kHz | 33 | nF | ±10%, ±20% | 0.50 | ±0.05 | ±0.05 | 7.5% | | (I) |
| | C1005X5R473□DTS | C1005X5R473□DT | 1V, 1kHz | 47 | nF | ±10%, ±20% | 0.50 | ±0.05 | ±0.05 | 7.5% | | (I) |
| | C1005X5R563□DTS | C1005X5R563□DT | 1V, 1kHz | 56 | nF | ±10%, ±20% | 0.50 | ±0.05 | ±0.05 | 7.5% | | (I) |
| | C1005X5R683□DTS | C1005X5R683□DT | 1V, 1kHz | 68 | nF | ±10%, ±20% | 0.50 | ±0.05 | ±0.05 | 7.5% | | (I) |
| | C1005X5R823□DTS | C1005X5R823□DT | 1V, 1kHz | 82 | nF | ±10%, ±20% | 0.50 | ±0.05 | ±0.05 | 7.5% | | (I) |
| | C1005X5R104□DTS | C1005X5R104□DT | 1V, 1kHz | 100 | nF | ±10%, ±20% | 0.50 | ±0.05 | ±0.05 | 7.5% | | (I) |
| | C1005X5R124□DTS | C1005X5R124□DT | 1V, 1kHz | 120 | nF | ±10%, ±20% | 0.50 | ±0.05 | ±0.05 | 7.5% | | (II) |
| | C1005X5R154□DTS | C1005X5R154□DT | 1V, 1kHz | 150 | nF | ±10%, ±20% | 0.50 | ±0.05 | ±0.05 | 7.5% | | (II) |
| | C1005X5R184□DTS | C1005X5R184□DT | 1V, 1kHz | 180 | nF | ±10%, ±20% | 0.50 | ±0.05 | ±0.05 | 7.5% | | (II) |
| | C1005X5R224□DTS | C1005X5R224□DT | 1V, 1kHz | 220 | nF | ±10%, ±20% | 0.50 | ±0.05 | ±0.05 | 7.5% | | (II) |
| | C1005X5R334□DTS | C1005X5R334□DT | 1V, 1kHz | 330 | nF | ±10%, ±20% | 0.50 | ±0.05 | ±0.05 | 10.0% | | (II) |
| | C1005X5R394□DTS | C1005X5R394□DT | 1V, 1kHz | 390 | nF | ±10%, ±20% | 0.50 | ±0.05 | ±0.05 | 10.0% | | (II) |
| | C1005X5R474□DTS | C1005X5R474□DT | 1V, 1kHz | 470 | nF | ±10%, ±20% | 0.50 | ±0.05 | ±0.05 | 10.0% | | (II) |
| | C1005X5R684□DTS | C1005X5R684□DT | 1V, 1kHz | 680 | nF | ±10%, ±20% | 0.50 | ±0.05 | ±0.05 | 10.0% | | (II) |
| | C1005X5R105□DTS | C1005X5R105□DT | 1V, 1kHz | 1.0 | uF | ±10%, ±20% | 0.50 | ±0.05 | ±0.05 | 10.0% | | (II) |
| | C1005X5R225□DTS | C1005X5R225□DT | 0.5V, 1kHz | 2.2 | uF | ±10%, ±20% | 0.50 | ±0.05 | ±0.05 | 10.0% | | (III)* |
| | C1005X5R475□DTS | C1005X5R475□DT | 1V, 1kHz | 4.7 | uF | ±10%, ±20% | 0.50 | ±0.15 | ±0.15 | 12.5% | | (III)* |
| | C1005X5R106MDTS | C1005X5R106MDT | 0.5V, 1kHz | 10 | uF | ±20% | 0.50 | ±0.20 | ±0.20 | 12.5% | | (III)* |
| 6.3V | C1005X5R223KCTS | C1005X5R223KCT | 1V, 1kHz | 22 | nF | ±10% | 0.50 | ±0.05 | ±0.05 | 7.5% | Paper, 10Kpcs | (I) |
| | C1005X5R224□CTS | C1005X5R224□CT | 1V, 1kHz | 220 | nF | ±10%, ±20% | 0.50 | ±0.05 | ±0.05 | 10.0% | | (II) |
| | C1005X5R334□CTS | C1005X5R334□CT | 1V, 1kHz | 330 | nF | ±10%, ±20% | 0.50 | ±0.05 | ±0.05 | 10.0% | | (II) |
| | C1005X5R474□CTS | C1005X5R474□CT | 1V, 1kHz | 470 | nF | ±10%, ±20% | 0.50 | ±0.05 | ±0.05 | 10.0% | | (II) |
| | C1005X5R684□CTS | C1005X5R684□CT | 1V, 1kHz | 680 | nF | ±10%, ±20% | 0.50 | ±0.05 | ±0.05 | 10.0% | Paper, 15Kpcs | (II) |
| | C1005X5R105MCTSA | | 1V, 1kHz | 1.0 | uF | ±20% | 0.30 | ±0.05 | ±0.03 | 12.5% | | (III)* |
| | C1005X5R105□CTS | C1005X5R105□CT | 0.5V, 1kHz | 1.0 | uF | ±10%, ±20% | 0.50 | ±0.05 | ±0.05 | 12.5% | Paper, 10Kpcs | (II) |
| | C1005X5R225MCTSA | | 0.5V, 1kHz | 2.2 | uF | ±20% | 0.30 | ±0.05 | ±0.03 | 10.0% | Paper, 15Kpcs | (III)* |
| | C1005X5R225□CTS | C1005X5R225□CT | 0.5V, 1kHz | 2.2 | uF | ±10%, ±20% | 0.50 | ±0.05 | ±0.05 | 10.0% | Paper, 10Kpcs | (III)* |
| | C1005X5R475MCTSA | | 0.5V, 1kHz | 4.7 | uF | ±20% | 0.30 | ±0.20 | ±0.03 | 10.0% | Paper, 15Kpcs | (III)* |
| | C1005X5R475□CTS | C1005X5R475□CT | 0.5V, 1kHz | 4.7 | uF | ±10%, ±20% | 0.50 | ±0.15 | ±0.15 | 10.0% | Paper, 10Kpcs | (III)* |
| | C1005X5R106MCTS | C1005X5R106MCT | 0.5V, 1kHz | 10 | uF | ±20% | 0.50 | ±0.20 | ±0.20 | 15.0% | | (III)* |
| C1005X5R226MCTS | C1005X5R226MCT | 0.5V, 120Hz | 22 | uF | ±20% | 0.50 | ±0.20 | ±0.20 | 15.0% | (III)* | | |
| 4V | C1005X5R105□BTS | C1005X5R105□BT | 1V, 1kHz | 1.0 | uF | ±10%, ±20% | 0.50 | ±0.05 | ±0.05 | 15.0% | Paper, 10Kpcs | (II) |
| | C1005X5R225□BTS | C1005X5R225□BT | 0.5V, 1kHz | 2.2 | uF | ±10%, ±20% | 0.50 | ±0.05 | ±0.05 | 10.0% | | (II) |
| | C1005X5R225MBTSA | | 0.5V, 1kHz | 2.2 | uF | ±20% | 0.30 | ±0.05 | ±0.03 | 10.0% | Paper, 15Kpcs | (II) |
| | C1005X5R475□BTS | C1005X5R475□BT | 0.5V, 1kHz | 4.7 | uF | ±10%, ±20% | 0.50 | ±0.15 | ±0.15 | 10.0% | Paper, 10Kpcs | (II) |
| | C1005X5R106MBTS | C1005X5R106MBT | 0.5V, 1kHz | 10.0 | uF | ±20% | 0.50 | ±0.20 | ±0.20 | 15.0% | | (II) |
| C1005X5R226MBTS | C1005X5R226MBT | 0.5V, 120Hz | 22 | uF | ±20% | 0.50 | ±0.20 | ±0.20 | 15.0% | (II)* | | |

□ Tolerance Code: K=±10%, M=±20% ;Special tolerance on the request.

(II)* High temperature load life test are applicable in rated voltage *100%

● C1608X5R Series (EIA0603)

| RV | DARFON P/N | DARFON P/N 2 | Measuring Condition | Capacitance | | Available Tolerance | Thick. (mm) | Tolerance(mm) | | DF (max.) | Standard Packing | Test Spec. |
|-----------------|------------------|----------------|---------------------|-------------|------|---------------------|-------------|---------------|----------|-----------------|------------------|------------|
| | | | | Value | Unit | | | L/W | Thick. | | | |
| 50V | C1608X5R102KGTS | C1608X5R102KGT | 1V, 1kHz | 1.0 | nF | ±10% | 0.80 | ±0.10 | ±0.10 | 5.0% | Paper, 4Kpcs | (I) |
| | C1608X5R103KGTS | C1608X5R103KGT | 1V, 1kHz | 10 | nF | ±10% | 0.80 | ±0.10 | ±0.10 | 5.0% | | (I) |
| | C1608X5R333KGTS | C1608X5R333KGT | 1V, 1kHz | 33 | nF | ±10% | 0.80 | ±0.15 | ±0.15 | 5.0% | | (I) |
| | C1608X5R224KGT | C1608X5R224KGT | 1V, 1kHz | 220 | nF | ±10% | 0.80 | ±0.15 | ±0.15 | 5.0% | | (II) |
| | C1608X5R474□GTS | C1608X5R474□GT | 1V, 1kHz | 470 | nF | ±10%, ±20% | 0.80 | ±0.15 | ±0.15 | 10.0% | | (II) |
| | C1608X5R105□GTS | C1608X5R105□GT | 1V, 1kHz | 1.0 | uF | ±10%, ±20% | 0.80 | ±0.10 | ±0.10 | 10.0% | | (II) |
| 35V | C1608X5R225□GTS | C1608X5R225□GT | 1V, 1kHz | 2.2 | uF | ±10%, ±20% | 0.80 | ±0.20 | ±0.20 | 10.0% | Paper, 4Kpcs | (II) |
| | C1608X5R105□NTS | C1608X5R105□NT | 1V, 1kHz | 1.0 | uF | ±10%, ±20% | 0.80 | ±0.10 | ±0.10 | 10.0% | | (II)* |
| | C1608X5R225□NTS | C1608X5R225□NT | 1V, 1kHz | 2.2 | uF | ±10%, ±20% | 0.80 | ±0.10 | ±0.10 | 10.0% | | (II)* |
| | C1608X5R475□NTS | C1608X5R475□NT | 1V, 1kHz | 4.7 | uF | ±10%, ±20% | 0.80 | ±0.20 | ±0.20 | 10.0% | | (II)* |
| 25V | C1608X5R106MNTS | C1608X5R106MNT | 1V, 1kHz | 10 | uF | ±20% | 0.80 | ±0.20 | ±0.20 | 10.0% | Paper, 4Kpcs | (II)* |
| | C1608X5R104□FTS | C1608X5R104□FT | 1V, 1kHz | 100 | nF | ±10%, ±20% | 0.80 | ±0.10 | ±0.10 | 5.0% | | (I) |
| | C1608X5R224□FTS | C1608X5R224□FT | 1V, 1kHz | 220 | nF | ±10%, ±20% | 0.80 | ±0.10 | ±0.10 | 5.0% | | (I) |
| | C1608X5R334KFTS | C1608X5R334KFT | 1V, 1kHz | 330 | nF | ±10% | 0.80 | ±0.15 | ±0.15 | 7.5% | | (I) |
| | C1608X5R474□FTS | C1608X5R474□FT | 1V, 1kHz | 470 | nF | ±10%, ±20% | 0.80 | ±0.10 | ±0.10 | 5.0% | | (II) |
| | C1608X5R105□FTS | C1608X5R105□FT | 1V, 1kHz | 1.0 | uF | ±10%, ±20% | 0.80 | ±0.15 | ±0.15 | 10.0% | | (II) |
| | C1608X5R105□FTSB | | 1V, 1kHz | 1.0 | uF | ±10%, ±20% | 0.50 | ±0.10 | +0/-0.10 | 12.5% | | (II)* |
| | C1608X5R225□FTS | C1608X5R225□FT | 1V, 1kHz | 2.2 | uF | ±10%, ±20% | 0.80 | ±0.15 | ±0.15 | 10.0% | | (II) |
| 16V | C1608X5R475□FTS | C1608X5R475□FT | 1V, 1kHz | 4.7 | uF | ±10%, ±20% | 0.80 | ±0.20 | ±0.20 | 10.0% | Paper, 4Kpcs | (II) |
| | C1608X5R106MFTS | C1608X5R106MFT | 1V, 1kHz | 10 | uF | ±20% | 0.80 | ±0.20 | ±0.20 | 10.0% | | (II) |
| | C1608X5R104□ETS | C1608X5R104□ET | 1V, 1kHz | 100 | nF | ±10%, ±20% | 0.80 | ±0.10 | ±0.10 | 5.0% | | (I) |
| | C1608X5R224□ETS | C1608X5R224□ET | 1V, 1kHz | 220 | nF | ±10%, ±20% | 0.80 | ±0.10 | ±0.10 | 5.0% | | (I) |
| | C1608X5R334□ETS | C1608X5R334□ET | 1V, 1kHz | 330 | nF | ±10%, ±20% | 0.80 | ±0.10 | ±0.10 | 5.0% | | (I) |
| | C1608X5R474□ETS | C1608X5R474□ET | 1V, 1kHz | 470 | nF | ±10%, ±20% | 0.80 | ±0.10 | ±0.10 | 3.5% | | (II) |
| | C1608X5R684□ETS | C1608X5R684□ET | 1V, 1kHz | 680 | nF | ±10%, ±20% | 0.80 | ±0.10 | ±0.10 | 7.5% | | (II) |
| | C1608X5R105□ETS | C1608X5R105□ET | 1V, 1kHz | 1.0 | uF | ±10%, ±20% | 0.80 | ±0.10 | ±0.10 | 10.0% | | (II) |
| | C1608X5R105□ETSB | | 0.5V, 1kHz | 1.0 | uF | ±10%, ±20% | 0.50 | ±0.10 | +0/-0.10 | 10.0% | | (II) |
| | C1608X5R225□ETS | C1608X5R225□ET | 1V, 1kHz | 2.2 | uF | ±10%, ±20% | 0.80 | ±0.10 | ±0.10 | 10.0% | | (II) |
| 10V | C1608X5R475□ETS | C1608X5R475□ET | 1V, 1kHz | 4.7 | uF | ±10%, ±20% | 0.80 | ±0.20 | ±0.15 | 10.0% | Paper, 4Kpcs | (II)* |
| | C1608X5R106□ETS | C1608X5R106□ET | 1V, 1kHz | 10 | uF | ±10%, ±20% | 0.80 | ±0.20 | ±0.20 | 10.0% | | (II)* |
| | C1608X5R104□DTS | C1608X5R104□DT | 1V, 1kHz | 100 | nF | ±10%, ±20% | 0.80 | ±0.10 | ±0.10 | 7.5% | | (I) |
| | C1608X5R224□DTS | C1608X5R224□DT | 1V, 1kHz | 220 | nF | ±10%, ±20% | 0.80 | ±0.10 | ±0.10 | 7.5% | | (I) |
| | C1608X5R334□DTS | C1608X5R334□DT | 1V, 1kHz | 330 | nF | ±10%, ±20% | 0.80 | ±0.10 | ±0.10 | 7.5% | | (I) |
| | C1608X5R474□DTS | C1608X5R474□DT | 1V, 1kHz | 470 | nF | ±10%, ±20% | 0.80 | ±0.10 | ±0.10 | 7.5% | | (I) |
| | C1608X5R684□DTS | C1608X5R684□DT | 1V, 1kHz | 680 | nF | ±10%, ±20% | 0.80 | ±0.10 | ±0.10 | 7.5% | | (I) |
| | C1608X5R105□DTS | C1608X5R105□DT | 1V, 1kHz | 1.0 | uF | ±10%, ±20% | 0.80 | ±0.10 | ±0.10 | 7.5% | | (II) |
| | C1608X5R105□DTSB | | 1V, 1kHz | 1.0 | uF | ±10%, ±20% | 0.50 | ±0.10 | +0/-0.10 | 10.0% | | (II) |
| | C1608X5R225□DTS | C1608X5R225□DT | 1V, 1kHz | 2.2 | uF | ±10%, ±20% | 0.80 | ±0.10/±0.15 | ±0.15 | 10.0% | | (II) |
| | C1608X5R225□DTSB | | 0.5V, 1kHz | 2.2 | uF | ±10%, ±20% | 0.50 | ±0.10 | +0/-0.10 | 10.0% | | (II)* |
| | C1608X5R335□DTS | C1608X5R335□DT | 1V, 1kHz | 3.3 | uF | ±10%, ±20% | 0.80 | ±0.15 | ±0.15 | 10.0% | | (II) |
| | C1608X5R475□DTS | C1608X5R475□DT | 1V, 1kHz | 4.7 | uF | ±10%, ±20% | 0.80 | ±0.15 | ±0.15 | 10.0% | | (II) |
| | C1608X5R475□DTSB | | 1V, 1kHz | 4.7 | uF | ±10%, ±20% | 0.50 | ±0.20 | ±0.05 | 10.0% | | (II) |
| | C1608X5R106□DTS | C1608X5R106□DT | 1V, 1kHz | 10 | uF | ±10%, ±20% | 0.80 | ±0.20 | ±0.20 | 10.0% | | (II)* |
| | C1608X5R226MDTS | C1608X5R226MDT | 0.5V, 120Hz | 22 | uF | ±20% | 0.80 | ±0.25 | ±0.25 | 10.0% | | (II)* |
| C1608X5R226MDWS | C1608X5R226MDW | 0.5V, 120Hz | 22 | uF | ±20% | 0.80 | ±0.20 | ±0.20 | 10.0% | Embossed, 4Kpcs | | |
| 6.3V | C1608X5R104□CTS | C1608X5R104□CT | 1V, 1kHz | 100 | nF | ±10%, ±20% | 0.80 | ±0.10 | ±0.10 | 7.5% | Paper, 4Kpcs | (I) |
| | C1608X5R105□CTS | C1608X5R105□CT | 1V, 1kHz | 1.0 | uF | ±10%, ±20% | 0.80 | ±0.10 | ±0.10 | 7.5% | | (II) |
| | C1608X5R225□CTS | C1608X5R225□CT | 0.5V, 1kHz | 2.2 | uF | ±10%, ±20% | 0.80 | ±0.10 | ±0.10 | 10.0% | | (II) |
| | C1608X5R335KCTS | C1608X5R335KCT | 1V, 1kHz | 3.3 | uF | ±10% | 0.80 | ±0.15 | ±0.15 | 10.0% | | (II) |
| | C1608X5R475□CTS | C1608X5R475□CT | 0.5V, 1kHz | 4.7 | uF | ±10%, ±20% | 0.80 | ±0.10 | ±0.10 | 10.0% | | (II) |
| | C1608X5R106MCTS | | 0.5V, 1kHz | 10 | uF | ±20% | 0.50 | ±0.10 | ±0.10 | 10.0% | | (II)* |
| | C1608X5R106□CTS | C1608X5R106□CT | 0.5V, 1kHz | 10 | uF | ±10%, ±20% | 0.80 | ±0.15 | ±0.15 | 10.0% | | (II)* |
| | C1608X5R226MCTS | C1608X5R226MCT | 0.5V, 120Hz | 22 | uF | ±20% | 0.80 | ±0.20 | ±0.20 | 15.0% | | (II)* |
| 4V | C1608X5R476MCTS | C1608X5R476MCT | 0.5V, 120Hz | 47 | uF | ±20% | 0.80 | ±0.20 | ±0.20 | 12.5% | (II)* | |
| | C1608X5R106MBTS | C1608X5R106MBT | 0.5V, 1kHz | 10 | uF | ±20% | 0.80 | ±0.10 | ±0.10 | 10.0% | Paper, 4Kpcs | (II) |
| | C1608X5R226MBTS | C1608X5R226MBT | 0.5V, 120Hz | 22 | uF | ±20% | 0.80 | ±0.20 | ±0.20 | 10.0% | | (II)* |
| | C1608X5R476MBTS | C1608X5R476MBT | 0.5V, 120Hz | 47 | uF | ±20% | 0.80 | ±0.20 | ±0.20 | 12.5% | (II)* | |

● C2012X5R Series (EIA0805)

| RV | DARFON P/N | DARFON P/N 2 | Measuring Condition | Capacitance | | Available Tolerance | Thick. (mm) | Tolerance(mm) | | DF (max.) | Standard Packing | Test Spec. |
|-----------------|-----------------|----------------|---------------------|-------------|------|---------------------|-------------|---------------|--------|-----------------|------------------|------------|
| | | | | Value | Unit | | | L/W | Thick. | | | |
| 50V | C2012X5R105□GTS | C2012X5R105□GT | 1V, 1kHz | 1.0 | uF | ±10%, ±20% | 0.85 | ±0.15 | ±0.15 | 10.0% | Paper, 4Kpcs | (II) |
| | C2012X5R225□GTS | C2012X5R225□GT | 1V, 1kHz | 2.2 | uF | ±10%, ±20% | 0.85 | ±0.20 | ±0.15 | 10.0% | | (II) |
| | C2012X5R105□GPS | C2012X5R105□GP | 1V, 1kHz | 1.0 | uF | ±10%, ±20% | 1.25 | ±0.15 | ±0.20 | 10.0% | Embossed, 3Kpcs | (II) |
| | C2012X5R225□GPS | C2012X5R225□GP | 1V, 1kHz | 2.2 | uF | ±10%, ±20% | 1.25 | ±0.15 | ±0.20 | 10.0% | | (II) |
| | C2012X5R475□GPS | C2012X5R475□GP | 1V, 1kHz | 4.7 | uF | ±10%, ±20% | 1.25 | ±0.20 | ±0.20 | 10.0% | | (II)* |
| C2012X5R106MGPS | C2012X5R106MGP | 1V, 1kHz | 10.0 | uF | ±20% | 1.25 | ±0.20 | ±0.20 | 10.0% | (II)* | | |
| 35V | C2012X5R106KNPS | C2012X5R106KNP | 1V, 1kHz | 10.0 | uF | ±10% | 1.25 | ±0.20 | ±0.20 | 10.0% | Embossed, 3Kpcs | (II)* |
| 25V | C2012X5R105□FTS | C2012X5R105□FT | 1V, 1kHz | 1.0 | uF | ±10%, ±20% | 0.85 | ±0.15 | ±0.10 | 10.0% | Paper, 4Kpcs | (II) |
| | C2012X5R105□FPS | C2012X5R105□FP | 1V, 1kHz | 1.0 | uF | ±10%, ±20% | 1.25 | ±0.20 | ±0.20 | 10.0% | Embossed, 3Kpcs | (I) |
| | C2012X5R225□FTS | C2012X5R225□FT | 1V, 1kHz | 2.2 | uF | ±10%, ±20% | 0.85 | ±0.20 | ±0.10 | 10.0% | Paper, 4Kpcs | (II) |
| | C2012X5R225□FPS | C2012X5R225□FP | 1V, 1kHz | 2.2 | uF | ±10%, ±20% | 1.25 | ±0.15 | ±0.20 | 10.0% | Embossed, 3Kpcs | (II) |
| | C2012X5R475□FTS | C2012X5R475□FT | 1V, 1kHz | 4.7 | uF | ±10%, ±20% | 0.85 | ±0.20 | ±0.10 | 10.0% | Paper, 4Kpcs | (II)* |
| | C2012X5R475□FPS | C2012X5R475□FP | 1V, 1kHz | 4.7 | uF | ±10%, ±20% | 1.25 | ±0.15 | ±0.20 | 10.0% | Embossed, 3Kpcs | (II) |
| | C2012X5R106□FTS | C2012X5R106□FT | 1V, 1kHz | 10 | uF | ±10%, ±20% | 0.85 | ±0.20 | ±0.10 | 12.5% | Paper, 4Kpcs | (II)* |
| | C2012X5R106□FPS | C2012X5R106□FP | 1V, 1kHz | 10 | uF | ±10%, ±20% | 1.25 | ±0.20 | ±0.20 | 12.5% | Embossed, 3Kpcs | (II)* |
| | C2012X5R226MFPS | C2012X5R226MFP | 0.5V, 120Hz | 22 | uF | ±20% | 1.25 | ±0.20 | ±0.20 | 15.0% | Embossed, 3Kpcs | (II) |
| | C2012X5R226MFWS | C2012X5R226MFW | 0.5V, 120Hz | 22 | uF | ±20% | 1.25 | ±0.20 | ±0.20 | 15.0% | Embossed, 2Kpcs | (II) |
| 16V | C2012X5R105□ETS | C2012X5R105□ET | 1V, 1kHz | 1.0 | uF | ±10%, ±20% | 0.85 | ±0.15 | ±0.15 | 10.0% | Paper, 4Kpcs | (II) |
| | C2012X5R105□EPS | C2012X5R105□EP | 1V, 1kHz | 1.0 | uF | ±10%, ±20% | 1.25 | ±0.15 | ±0.20 | 5.0% | Embossed, 3Kpcs | (I) |
| | C2012X5R225□ETS | C2012X5R225□ET | 1V, 1kHz | 2.2 | uF | ±10%, ±20% | 1.25 | ±0.15 | ±0.20 | 5.0% | | (II) |
| | C2012X5R335□ETS | C2012X5R335□ET | 1V, 1kHz | 3.3 | uF | ±10%, ±20% | 1.25 | ±0.20 | ±0.20 | 10.0% | | (II) |
| | C2012X5R475□ETS | C2012X5R475□ET | 0.5V, 1kHz | 4.7 | uF | ±10%, ±20% | 0.85 | ±0.20 | ±0.10 | 10.0% | Paper, 4Kpcs | (II) |
| | C2012X5R475□EPS | C2012X5R475□EP | 1V, 1kHz | 4.7 | uF | ±10%, ±20% | 1.25 | ±0.15 | ±0.20 | 7.5% | Embossed, 3Kpcs | (II) |
| | C2012X5R106□ETS | C2012X5R106□ET | 1V, 1kHz | 10 | uF | ±10%, ±20% | 0.85 | ±0.15 | ±0.10 | 10.0% | Paper, 4Kpcs | (II)* |
| | C2012X5R106□EPS | C2012X5R106□EP | 0.5V, 1kHz | 10 | uF | ±10%, ±20% | 1.25 | ±0.15 | ±0.20 | 10.0% | Embossed, 3Kpcs | (II)* |
| C2012X5R226METS | C2012X5R226MET | 0.5V, 120Hz | 22 | uF | ±20% | 0.85 | ±0.20 | ±0.10 | 10.0% | Paper, 4Kpcs | (II)* | |
| 10V | C2012X5R225□DTS | C2012X5R225□DT | 1V, 1kHz | 2.2 | uF | ±10%, ±20% | 0.85 | ±0.15 | ±0.10 | 10.0% | Paper, 4Kpcs | (II) |
| | C2012X5R335□DPS | C2012X5R335□DP | 1V, 1kHz | 3.3 | uF | ±10%, ±20% | 1.25 | ±0.20 | ±0.20 | 10.0% | Embossed, 3Kpcs | (II) |
| | C2012X5R475□DPS | C2012X5R475□DP | 1V, 1kHz | 4.7 | uF | ±10%, ±20% | 1.25 | ±0.15 | ±0.20 | 10.0% | | (II) |
| | C2012X5R106□DTS | C2012X5R106□DT | 0.5V, 1kHz | 10 | uF | ±10%, ±20% | 0.85 | ±0.20 | ±0.10 | 10.0% | Paper, 4Kpcs | (II) |
| | C2012X5R106□DPS | C2012X5R106□DP | 0.5V, 1kHz | 10 | uF | ±10%, ±20% | 1.25 | ±0.15 | ±0.20 | 10.0% | Embossed, 3Kpcs | (II) |
| | C2012X5R226MDTS | C2012X5R226MDT | 0.5V, 120Hz | 22 | uF | ±20% | 0.85 | ±0.20 | ±0.15 | 10.0% | Paper, 4Kpcs | (II)* |
| | C2012X5R476MDPS | C2012X5R476MDP | 0.5V, 120Hz | 47 | uF | ±20% | 1.25 | ±0.20 | ±0.20 | 10.0% | Embossed, 3Kpcs | (II)* |
| 6.3V | C2012X5R225KCTS | C2012X5R225KCT | 1V, 1kHz | 2.2 | uF | ±10% | 0.85 | ±0.15 | ±0.10 | 10.0% | Paper, 4Kpcs | (II) |
| | C2012X5R475□CPS | C2012X5R475□CP | 0.5V, 1kHz | 4.7 | uF | ±10%, ±20% | 1.25 | ±0.15 | ±0.20 | 10.0% | Embossed, 3Kpcs | (I) |
| | C2012X5R106□CTS | C2012X5R106□CT | 0.5V, 1kHz | 10 | uF | ±10%, ±20% | 0.85 | ±0.20 | ±0.15 | 10.0% | Paper, 4Kpcs | (II) |
| | C2012X5R106□CPS | C2012X5R106□CP | 0.5V, 1kHz | 10 | uF | ±10%, ±20% | 1.25 | ±0.15 | ±0.20 | 10.0% | Embossed, 3Kpcs | (II) |
| | C2012X5R226MCTS | C2012X5R226MCT | 0.5V, 120Hz | 22 | uF | ±20% | 0.85 | ±0.15 | ±0.15 | 10.0% | Paper, 4Kpcs | (II) |
| | C2012X5R226□CPS | C2012X5R226□CP | 0.5V, 120Hz | 22 | uF | ±10%, ±20% | 1.25 | ±0.15 | ±0.15 | 10.0% | Embossed, 3Kpcs | (II) |
| | C2012X5R476MCTS | C2012X5R476MCT | 0.5V, 120Hz | 47 | uF | ±20% | 0.85 | ±0.20 | ±0.15 | 10.0% | Paper, 4Kpcs | (II)* |
| | C2012X5R476MCPS | C2012X5R476MCP | 0.5V, 120Hz | 47 | uF | ±20% | 1.25 | ±0.20 | ±0.20 | 10.0% | Embossed, 3Kpcs | (II)* |
| C2012X5R107MCPS | C2012X5R107MCP | 0.5V, 120Hz | 100 | uF | ±20% | 1.25 | ±0.20 | ±0.20 | 10.0% | Embossed, 3Kpcs | (II)* | |
| 4V | C2012X5R107MBPS | C2012X5R107MBP | 0.5V, 120Hz | 100 | uF | ±20% | 1.25 | ±0.20 | ±0.20 | 10.0% | Embossed, 3Kpcs | (II)* |

□ Tolerance Code: K=±10%, M=±20% ;(II)* High temperature load life test are applicable in rated voltage *100%

● C3216X5R Series (EIA1206)

| RV | DARFON P/N | DARFON P/N 2 | Measuring Condition | Capacitance | | Available Tolerance | Thick. (mm) | Tolerance(mm) | | DF (max.) | Standard Packing | Test Spec. |
|------|-------------------|-----------------|---------------------|-------------|------|---------------------|-------------|---------------|--------|-----------|------------------|------------|
| | | | | Value | Unit | | | L/W | Thick. | | | |
| 50V | C3216X5R225□GTS | C3216X5R225□GT | 1V, 1kHz | 2.2 | uF | ±10%, ±20% | 0.85 | ±0.15 | ±0.10 | 10.0% | Paper, 4Kpcs | (II) |
| | C3216X5R475□GTS | C3216X5R475□GT | 1V, 1kHz | 4.7 | uF | ±10%, ±20% | 0.85 | ±0.15 | ±0.10 | 10.0% | | (II) |
| | C3216X5R475□GPS | C3216X5R475□GP | 1V, 1kHz | 4.7 | uF | ±10%, ±20% | 1.60 | ±0.20 | ±0.30 | 10.0% | Embossed, 2Kpcs | (II) |
| | C3216X5R106□GPS | C3216X5R106□GP | 1V, 1kHz | 10 | uF | ±10%, ±20% | 1.60 | ±0.20 | ±0.20 | 10.0% | | (II) |
| 35V | C3216X5R106□NTS | C3216X5R106□NT | 1V, 1kHz | 10 | uF | ±10%, ±20% | 0.85 | ±0.15 | ±0.10 | 10.0% | Paper, 4Kpcs | (II)* |
| | C3216X5R106□NPS | C3216X5R106□NP | 1V, 1kHz | 10 | uF | ±10%, ±20% | 1.60 | ±0.20 | ±0.30 | 10.0% | Embossed, 2Kpcs | (II) |
| 25V | C3216X5R105KFTSE | | 1V, 1kHz | 1.0 | uF | ±10% | 0.85 | ±0.15 | ±0.10 | 3.5% | Paper, 4Kpcs | (I) |
| | C3216X5R225□FPS | C3216X5R225□FP | 1V, 1kHz | 2.2 | uF | ±10%, ±20% | 1.60 | ±0.20 | ±0.30 | 5.0% | Embossed, 2Kpcs | (I) |
| | C3216X5R475□FPS | C3216X5R475□FP | 1V, 1kHz | 4.7 | uF | ±10%, ±20% | 1.60 | ±0.20 | ±0.30 | 5.0% | | (I) |
| | C3216X5R106□FPS | C3216X5R106□FP | 1V, 1kHz | 10 | uF | ±10%, ±20% | 1.60 | ±0.20 | ±0.30 | 10.0% | | (II) |
| | C3216X5R226□MFTSE | C3216X5R226□MFT | 0.5V, 120Hz | 22 | uF | ±20% | 0.85 | ±0.20 | ±0.20 | 10.0% | Paper, 4Kpcs | (II)* |
| | C3216X5R226□FPSSL | C3216X5R226□FP | 0.5V, 120Hz | 22 | uF | ±10%, ±20% | 1.60 | ±0.30 | ±0.30 | 10.0% | Embossed, 2Kpcs | (II) |
| 16V | C3216X5R225□EPS | C3216X5R225□EP | 1V, 1kHz | 2.2 | uF | ±10%, ±20% | 1.60 | ±0.20 | ±0.30 | 5.0% | Embossed, 2Kpcs | (I) |
| | C3216X5R475□EPS | C3216X5R475□EP | 1V, 1kHz | 4.7 | uF | ±10%, ±20% | 1.60 | ±0.20 | ±0.30 | 5.0% | | (I) |
| | C3216X5R106□EPS | C3216X5R106□EP | 1V, 1kHz | 10 | uF | ±10%, ±20% | 1.60 | ±0.20 | ±0.30 | 10.0% | | (II) |
| | C3216X5R226□EPS | C3216X5R226□EP | 0.5V, 120Hz | 22 | uF | ±10%, ±20% | 1.60 | ±0.20 | ±0.30 | 10.0% | | (II) |
| | C3216X5R226□METSE | C3216X5R226□MET | 0.5V, 120Hz | 22 | uF | ±20% | 0.85 | ±0.20 | ±0.20 | 10.0% | Paper, 4Kpcs | (II)* |
| | C3216X5R476MEPS | C3216X5R476MEP | 0.5V, 120Hz | 47 | uF | ±20% | 1.60 | ±0.30 | ±0.30 | 10.0% | Embossed, 2Kpcs | (II) |
| 10V | C3216X5R225□DPS | C3216X5R225□DP | 1V, 1kHz | 2.2 | uF | ±10%, ±20% | 1.60 | ±0.20 | ±0.30 | 7.5% | Embossed, 2Kpcs | (I) |
| | C3216X5R475□DPS | C3216X5R475□DP | 1V, 1kHz | 4.7 | uF | ±10%, ±20% | 1.60 | ±0.20 | ±0.30 | 7.5% | | (I) |
| | C3216X5R106□DPS | C3216X5R106□DP | 1V, 1kHz | 10 | uF | ±10%, ±20% | 1.60 | ±0.20 | ±0.30 | 10.0% | | (II) |
| | C3216X5R226□DPS | C3216X5R226□DP | 0.5V, 120Hz | 22 | uF | ±10%, ±20% | 1.60 | ±0.20 | ±0.30 | 10.0% | | (II) |
| | C3216X5R226□MDTSE | C3216X5R226□MDT | 0.5V, 120Hz | 22 | uF | ±20% | 0.85 | ±0.20 | ±0.20 | 10.0% | Paper, 4Kpcs | (II)* |
| | C3216X5R476□DPS | C3216X5R476□DP | 0.5V, 120Hz | 47 | uF | ±10%, ±20% | 1.60 | ±0.20 | ±0.30 | 10.0% | Embossed, 2Kpcs | (II) |
| 6.3V | C3216X5R106KCPS | C3216X5R106KCP | 1V, 1kHz | 10 | uF | ±10% | 1.60 | ±0.20 | ±0.30 | 15.0% | Embossed, 2Kpcs | (II) |
| | C3216X5R226□CPS | C3216X5R226□CP | 0.5V, 120Hz | 22 | uF | ±10%, ±20% | 1.60 | ±0.20 | ±0.30 | 15.0% | | (II) |
| | C3216X5R476MCPS | C3216X5R476MCP | 0.5V, 120Hz | 47 | uF | ±20% | 1.60 | ±0.20 | ±0.20 | 10.0% | | (II) |
| | C3216X5R107MCPS | C3216X5R107MCP | 0.5V, 120Hz | 100 | uF | ±20% | 1.60 | ±0.30 | ±0.30 | 15.0% | | (II) |
| 4V | C3216X5R106□BPS | C3216X5R106□BP | 0.5V, 120Hz | 22 | uF | ±10%, ±20% | 1.60 | ±0.20 | ±0.30 | 15.0% | Embossed, 2Kpcs | (II) |
| | C3216X5R476MBPS | C3216X5R476MBP | 0.5V, 120Hz | 47 | uF | ±20% | 1.60 | ±0.20 | ±0.30 | 15.0% | | (II) |
| | C3216X5R107MBPS | C3216X5R107MBP | 0.5V, 120Hz | 100 | uF | ±20% | 1.60 | ±0.30 | ±0.30 | 15.0% | | (II) |
| | C3216X5R227MBPSL | C3216X5R227MBP | 0.5V, 120Hz | 220 | uF | ±20% | 1.60 | ±0.30 | ±0.30 | 15.0% | | (II) |

● C3225X5R Series (EIA1210)

| RV | DARFON P/N | DARFON P/N 2 | Measuring Condition | Capacitance | | Available Tolerance | Thick. (mm) | Tolerance(mm) | | DF (max.) | Standard Packing | Test Spec. |
|------|------------------|----------------|---------------------|-------------|------|---------------------|-------------|---------------|-----------|-----------|-------------------|------------|
| | | | | Value | Unit | | | L/W | Thick. | | | |
| 50V | C3225X5R106□GPS | C3225X5R106□GP | 1V, 1kHz | 10 | uF | ±10%, ±20% | 2.50 | ±0.30/±0.20 | ±0.20 | 5.0% | Embossed, 1Kpcs | (II) |
| 35V | C3225X5R106□NPS | C3225X5R106□NP | 1V, 1kHz | 10 | uF | ±10%, ±20% | 2.50 | ±0.30/±0.20 | ±0.20 | 5.0% | Embossed, 1Kpcs | (I) |
| 25V | C3225X5R475□FWS | C3225X5R475□FW | 1V, 1kHz | 4.7 | uF | ±10%, ±20% | 2.00 | ±0.30/±0.20 | ±0.20 | 10.0% | Embossed, 1Kpcs | (I) |
| | C3225X5R106□FPS | C3225X5R106□FP | 1V, 1kHz | 10 | uF | ±10%, ±20% | 2.00 | ±0.30/±0.20 | ±0.20 | 10.0% | Embossed, 2Kpcs | (I) |
| 16V | C3225X5R226□FPS | C3225X5R226□FP | 0.5V, 120Hz | 22 | uF | ±10%, ±20% | 2.50 | ±0.30/±0.20 | ±0.20 | 10.0% | Embossed, 1Kpcs | (II) |
| | C3225X5R475□EWS | C3225X5R475□EW | 1V, 1kHz | 4.7 | uF | ±10%, ±20% | 2.00 | ±0.30/±0.20 | ±0.20 | 5.0% | Embossed, 1Kpcs | (I) |
| | C3225X5R106□EPS | C3225X5R106□EP | 1V, 1kHz | 10 | uF | ±10%, ±20% | 2.00 | ±0.30/±0.20 | ±0.20 | 5.0% | Embossed, 2Kpcs | (I) |
| | C3225X5R226□EWS | C3225X5R226□EW | 0.5V, 120Hz | 22 | uF | ±10%, ±20% | 2.50 | ±0.30/±0.20 | ±0.20 | 15.0% | Embossed, 0.5Kpcs | (II) |
| | C3225X5R226□EPS | C3225X5R226□EP | 0.5V, 120Hz | 22 | uF | ±10%, ±20% | 2.50 | ±0.30/±0.20 | ±0.20 | 15.0% | Embossed, 1Kpcs | (II) |
| | C3225X5R476MEPSS | C3225X5R476MEP | 0.5V, 120Hz | 47 | uF | ±20% | 1.90 | ±0.30/±0.20 | +0.1/-0.2 | 15.0% | Embossed, 2Kpcs | (II) |
| | C3225X5R476□EWS | C3225X5R476□EW | 0.5V, 120Hz | 47 | uF | ±10%, ±20% | 2.50 | ±0.30/±0.20 | ±0.20 | 15.0% | Embossed, 0.5Kpcs | (II) |
| | C3225X5R476□EPS | C3225X5R476□EP | 0.5V, 120Hz | 47 | uF | ±10%, ±20% | 2.50 | ±0.30/±0.20 | ±0.20 | 15.0% | Embossed, 1Kpcs | (II) |
| | C3225X5R107MEPS | C3225X5R107MEP | 0.5V, 120Hz | 100 | uF | ±20% | 2.50 | ±0.30 | ±0.30 | 10.0% | | (II) |
| 10V | C3225X5R226□DPS | C3225X5R226□DP | 0.5V, 120Hz | 22 | uF | ±10%, ±20% | 2.50 | ±0.30/±0.20 | ±0.20 | 10.0% | Embossed, 1Kpcs | (II) |
| | C3225X5R476□DPS | C3225X5R476□DP | 0.5V, 120Hz | 47 | uF | ±10%, ±20% | 2.50 | ±0.30/±0.20 | ±0.20 | 10.0% | | (II) |
| | C3225X5R107MDPS | C3225X5R107MDP | 0.5V, 120Hz | 100 | uF | ±20% | 2.50 | ±0.30/±0.20 | ±0.30 | 10.0% | | (II) |
| 6.3V | C3225X5R226□CPS | C3225X5R226□CP | 0.5V, 120Hz | 22 | uF | ±10%, ±20% | 2.50 | ±0.30/±0.20 | ±0.20 | 10.0% | Embossed, 1Kpcs | (II) |
| | C3225X5R476□CPS | C3225X5R476□CP | 0.5V, 120Hz | 47 | uF | ±10%, ±20% | 2.50 | ±0.30/±0.20 | ±0.20 | 15.0% | | (II) |
| | C3225X5R107MCPS | C3225X5R107MCP | 0.5V, 120Hz | 100 | uF | ±20% | 2.50 | ±0.30 | ±0.30 | 15.0% | | (II) |

● C4532X5R Series (EIA1812)

| RV | DARFON P/N | DARFON P/N 2 | Measuring Condition | Capacitance | | Available Tolerance | Thick. (mm) | Tolerance(mm) | | DF (max.) | Standard Packing | Test Spec. |
|-----|-----------------|----------------|---------------------|-------------|------|---------------------|-------------|---------------|--------|-----------|------------------|------------|
| | | | | Value | Unit | | | L/W | Thick. | | | |
| 50V | C4532X5R225KGPS | C4532X5R225KGP | 1V, 1kHz | 2.2 | uF | ±10% | 1.60 | ±0.30 | ±0.20 | 10.0% | Embossed, 1Kpcs | (II)* |

□ Tolerance Code: K=±10%, M=±20% ;Special tolerance on the request.;

(II)* High temperature load life test are applicable in rated voltage *100%

■ X6S Series

● C0603X6S Series (EIA0201)

| RV | DARFON P/N | DARFON P/N 2 | Measuring Condition | Capacitance | | Available Tolerance | Thick. (mm) | Tolerance(mm) | | DF (max.) | Standard Packing | Test Spec. |
|------|-----------------|----------------|---------------------|-------------|------|---------------------|-------------|---------------|--------|-----------|------------------|------------|
| | | | | Value | Unit | | | L/W | Thick. | | | |
| 25V | C0603X6S103KFTS | C0603X6S103KFT | 1V, 1kHz | 10 | nF | ±10% | 0.30 | ±0.03 | ±0.03 | 5.0% | Paper, 15Kpcs | (I) |
| | C0603X6S104KFTS | C0603X6S104KFT | 1V, 1kHz | 100 | nF | ±10% | 0.30 | ±0.03 | ±0.03 | 10.0% | | (II)* |
| 16V | C0603X6S103KETs | C0603X6S103KET | 1V, 1kHz | 10 | nF | ±10% | 0.30 | ±0.03 | ±0.03 | 5.0% | Paper, 15Kpcs | (I) |
| | C0603X6S104□ETS | C0603X6S104□ET | 1V, 1kHz | 100 | nF | ±10%, ±20% | 0.30 | ±0.03 | ±0.03 | 10.0% | | (II) |
| 10V | C0603X6S104KDTS | C0603X6S104KDT | 1V, 1kHz | 100 | nF | ±10% | 0.30 | ±0.03 | ±0.03 | 10.0% | Paper, 15Kpcs | (II) |
| | C0603X6S224□DTS | C0603X6S224□DT | 0.5V, 1kHz | 220 | nF | ±10%, ±20% | 0.30 | ±0.03 | ±0.03 | 10.0% | | (II) |
| 6.3V | C0603X6S103□CTS | C0603X6S103□CT | 1V, 1kHz | 10 | nF | ±10%, ±20% | 0.30 | ±0.03 | ±0.03 | 5.0% | Paper, 15Kpcs | (I) |
| | C0603X6S473□CTS | C0603X6S473□CT | 1V, 1kHz | 47 | nF | ±10%, ±20% | 0.30 | ±0.03 | ±0.03 | 10.0% | | (I) |
| | C0603X6S104□CTS | C0603X6S104□CT | 1V, 1kHz | 100 | nF | ±10%, ±20% | 0.30 | ±0.03 | ±0.03 | 10.0% | | (II)* |
| | C0603X6S224□CTS | C0603X6S224□CT | 0.5V, 1kHz | 220 | nF | ±10%, ±20% | 0.30 | ±0.03 | ±0.03 | 10.0% | | (II)* |
| | C0603X6S105MCTS | C0603X6S105MCT | 0.5V, 1kHz | 1 | uF | ±20% | 0.30 | ±0.09 | ±0.09 | 10.0% | | (II)* |
| 4V | C0603X6S104□BTS | C0603X6S104□BT | 0.5V, 1kHz | 100 | nF | ±10%, ±20% | 0.30 | ±0.03 | ±0.03 | 10.0% | Paper, 15Kpcs | (II) |
| | C0603X6S224□BTS | C0603X6S224□BT | 0.5V, 1kHz | 220 | nF | ±10%, ±20% | 0.30 | ±0.03 | ±0.03 | 10.0% | | (II) |
| | C0603X6S474MBTS | C0603X6S474MBT | 0.5V, 1kHz | 470 | nF | ±20% | 0.30 | ±0.03 | ±0.03 | 10.0% | | (II) |
| | C0603X6S105MBTS | C0603X6S105MBT | 0.5V, 1kHz | 1 | uF | ±20% | 0.30 | ±0.09 | ±0.09 | 10.0% | | (II)* |

● C1005X6S Series (EIA0402)

| RV | DARFON P/N | DARFON P/N 2 | Measuring Condition | Capacitance | | Available Tolerance | Thick. (mm) | Tolerance(mm) | | DF (max.) | Standard Packing | Test Spec. |
|------|-----------------|----------------|---------------------|-------------|------|---------------------|-------------|---------------|--------|-----------|------------------|------------|
| | | | | Value | Unit | | | L/W | Thick. | | | |
| 25V | C1005X6S104KFTS | C1005X6S104KFT | 1V, 1kHz | 100 | nF | ±10% | 0.50 | ±0.05 | ±0.05 | 10.0% | Paper, 10Kpcs | (II) |
| | C1005X6S224KFTS | C1005X6S224KFT | 1V, 1kHz | 220 | nF | ±10% | 0.50 | ±0.05 | ±0.05 | 10.0% | | (II) |
| | C1005X6S105□FTS | C1005X6S105□FT | 0.5V, 1kHz | 1.0 | uF | ±10%, ±20% | 0.50 | ±0.10 | ±0.10 | 10.0% | | (II)* |
| 16V | C1005X6S224KETs | C1005X6S224KET | 1V, 1kHz | 220 | nF | ±10% | 0.50 | ±0.05 | ±0.05 | 10.0% | Paper, 10Kpcs | (II) |
| | C1005X6S105□ETS | C1005X6S105□ET | 0.5V, 1kHz | 1.0 | uF | ±10%, ±20% | 0.50 | ±0.10 | ±0.10 | 12.5% | Paper, 10Kpcs | (II)* |
| | C1005X6S225METS | C1005X6S225MET | 1V, 1kHz | 2.2 | uF | ±20% | 0.50 | ±0.20 | ±0.20 | 10.0% | Paper, 10Kpcs | (II) |
| 10V | C1005X6S105□DTS | C1005X6S105□DT | 0.5V, 1kHz | 1.0 | uF | ±10%, ±20% | 0.50 | ±0.05 | ±0.05 | 12.5% | Paper, 10Kpcs | (II)* |
| | C1005X6S225□DTS | C1005X6S225□DT | 1V, 1kHz | 2.2 | uF | ±10%, ±20% | 0.50 | ±0.20 | ±0.20 | 10.0% | Paper, 10Kpcs | (II) |
| 6.3V | C1005X6S224KCTS | C1005X6S224KCT | 1V, 1kHz | 220 | nF | ±10% | 0.50 | ±0.05 | ±0.05 | 10.0% | Paper, 10Kpcs | (II) |
| | C1005X6S105□CTS | C1005X6S105□CT | 0.5V, 1kHz | 1.0 | uF | ±10%, ±20% | 0.50 | ±0.05 | ±0.05 | 10.0% | | (II)* |
| | C1005X6S225□CTS | C1005X6S225□CT | 0.5V, 1kHz | 2.2 | uF | ±10%, ±20% | 0.50 | ±0.05 | ±0.05 | 10.0% | | (II)* |
| | C1005X6S475MCTS | C1005X6S475MCT | 0.5V, 1kHz | 4.7 | uF | ±20% | 0.50 | ±0.15 | ±0.15 | 10.0% | | (II)* |
| | C1005X6S106MCTS | C1005X6S106MCT | 0.5V, 1kHz | 10 | uF | ±20% | 0.50 | ±0.20 | ±0.20 | 10.0% | | (II)* |
| 4V | C1005X6S106MBTS | C1005X6S106MBT | 0.5V, 1kHz | 10 | uF | ±20% | 0.50 | ±0.20 | ±0.20 | 10.0% | Paper, 10Kpcs | (II)* |

● C1608X6S Series (EIA0603)

| RV | DARFON P/N | DARFON P/N 2 | Measuring Condition | Capacitance | | Available Tolerance | Thick. (mm) | Tolerance(mm) | | DF (max.) | Standard Packing | Test Spec. |
|------|-----------------|----------------|---------------------|-------------|------|---------------------|-------------|---------------|--------|-----------|------------------|------------|
| | | | | Value | Unit | | | L/W | Thick. | | | |
| 25V | C1608X6S475□FTS | C1608X6S475□FT | 1V, 1kHz | 4.7 | uF | ±10%, ±20% | 0.80 | ±0.20 | ±0.20 | 10.0% | Paper, 4Kpcs | (II)* |
| 16V | C1608X6S105KETs | C1608X6S105KET | 1V, 1kHz | 1.0 | uF | ±10% | 0.80 | ±0.15 | ±0.15 | 10.0% | Paper, 4Kpcs | (II) |
| | C1608X6S225KETs | C1608X6S225KET | 1V, 1kHz | 2.2 | uF | ±10% | 0.80 | ±0.10 | ±0.10 | 10.0% | | (II) |
| | C1608X6S475KETs | C1608X6S475KET | 1V, 1kHz | 4.7 | uF | ±10% | 0.80 | ±0.20 | ±0.20 | 10.0% | | (II) |
| | C1608X6S106METS | C1608X6S106MET | 1V, 1kHz | 10 | uF | ±20% | 0.80 | ±0.20 | ±0.20 | 10.0% | | (II) |
| 10V | C1608X6S225DTS | C1608X6S225KDT | 1V, 1kHz | 2.2 | uF | ±10% | 0.80 | ±0.10 | ±0.10 | 10.0% | Paper, 4Kpcs | (II) |
| | C1608X6S475KDTS | C1608X6S475KDT | 1V, 1kHz | 4.7 | uF | ±10% | 0.80 | ±0.15 | ±0.15 | 10.0% | | (II) |
| | C1608X6S106MDTS | C1608X6S106MDT | 1V, 1kHz | 10 | uF | ±20% | 0.80 | ±0.20 | ±0.20 | 10.0% | | (II) |
| 6.3V | C1608X6S475□CTS | C1608X6S475□CT | 1V, 1kHz | 4.7 | uF | ±10%, ±20% | 0.80 | ±0.10 | ±0.10 | 10.0% | Paper, 4Kpcs | (II)* |
| | C1608X6S106MCTS | C1608X6S106MCT | 0.5V, 120Hz | 10 | uF | ±20% | 0.80 | ±0.20 | ±0.20 | 10.0% | | (II) |
| | C1608X6S226MCTS | C1608X6S226MCT | 0.5V, 120Hz | 22 | uF | ±20% | 0.80 | ±0.20 | ±0.20 | 10.0% | | (II)* |
| 4V | C1608X6S106MBTS | C1608X6S106MBT | 0.5V, 120Hz | 10 | uF | ±20% | 0.80 | ±0.20 | ±0.20 | 10.0% | Paper, 4Kpcs | (II) |
| | C1608X6S226MBTS | C1608X6S226MBT | 0.5V, 120Hz | 22 | uF | ±20% | 0.80 | ±0.20 | ±0.20 | 10.0% | | (II)* |

MLCC
General Purpose

● C2012X6S Series (EIA0805)

| RV | DARFON P/N | DARFON P/N 2 | Measuring Condition | Capacitance | | Available Tolerance | Thick. (mm) | Tolerance(mm) | | DF (max.) | Standard Packing | Test Spec. |
|------|-----------------|----------------|---------------------|-------------|------|---------------------|-------------|---------------|--------|-----------|------------------|------------|
| | | | | Value | Unit | | | L/W | Thick. | | | |
| 50V | C2012X6S475KGPS | C2012X6S475KGP | 1V , 1kHz | 4.7 | uF | ±10% | 1.25 | ±0.20 | ±0.20 | 10.0% | Embossed, 3Kpcs | (II) |
| 25V | C2012X6S106KFPS | C2012X6S106KFP | 0.5V , 1kHz | 10 | uF | ±10% | 1.25 | ±0.15 | ±0.20 | 12.5% | Embossed, 3Kpcs | (II)* |
| 16V | C2012X6S106KEPS | C2012X6S106KEP | 1V , 1kHz | 10 | uF | ±10% | 1.25 | ±0.15 | ±0.15 | 10.0% | Embossed, 3Kpcs | (II) |
| | C2012X6S226MEPS | C2012X6S226MEP | 0.5V , 120Hz | 22 | uF | ±20% | 1.25 | ±0.20 | ±0.20 | 10.0% | | (II)* |
| 10V | C2012X6S106KDPS | C2012X6S106KDP | 0.5V , 1kHz | 10 | uF | ±10% | 1.25 | ±0.15 | ±0.15 | 10.0% | Embossed, 3Kpcs | (II)* |
| | C2012X6S226MDPS | C2012X6S226MDP | 0.5V , 120Hz | 22 | uF | ±20% | 1.25 | ±0.20 | ±0.20 | 10.0% | | (II) |
| 6.3V | C2012X6S106MCPS | C2012X6S106MCP | 0.5V , 1kHz | 10 | uF | ±20% | 1.25 | ±0.15 | ±0.15 | 10.0% | Embossed, 3Kpcs | (II)* |
| | C2012X6S226MCPS | C2012X6S226MCP | 0.5V , 120Hz | 22 | uF | ±20% | 1.25 | ±0.15 | ±0.15 | 10.0% | | (II)* |
| 4V | C2012X6S106MBPS | C2012X6S106MBP | 0.5V , 1kHz | 10 | uF | ±20% | 1.25 | ±0.15 | ±0.15 | 10.0% | Embossed, 3Kpcs | (II) |
| | C2012X6S226MBPS | C2012X6S226MBP | 0.5V , 120Hz | 22 | uF | ±20% | 1.25 | ±0.15 | ±0.15 | 10.0% | | (II) |
| | C2012X6S476MBPS | C2012X6S476MBP | 0.5V , 120Hz | 47 | uF | ±20% | 1.25 | ±0.20 | ±0.20 | 10.0% | | (II)* |
| | C2012X6S107MBPS | C2012X6S107MBP | 0.5V , 120Hz | 100 | uF | ±20% | 1.25 | ±0.20 | ±0.20 | 10.0% | | (II)* |

● C3216X6S Series (EIA1206)

| RV | DARFON P/N | DARFON P/N 2 | Measuring Condition | Capacitance | | Available Tolerance | Thick. (mm) | Tolerance(mm) | | DF (max.) | Standard Packing | Test Spec. |
|------|-----------------|----------------|---------------------|-------------|------|---------------------|-------------|---------------|--------|-----------|------------------|------------|
| | | | | Value | Unit | | | L/W | Thick. | | | |
| 35V | C3216X6S106KNPS | C3216X6S106KNP | 1V , 1kHz | 10 | uF | ±10% | 1.60 | ±0.20 | ±0.20 | 10.0% | Embossed, 2Kpcs | (II) |
| 25V | C3216X6S106KFPS | C3216X6S106KFP | 1V , 1kHz | 10 | uF | ±10% | 1.60 | ±0.20 | ±0.20 | 10.0% | Embossed, 2Kpcs | (II) |
| | C3216X6S226□FPS | C3216X6S226□FP | 0.5V , 120Hz | 22 | uF | ±10%,±20% | 1.60 | ±0.30 | ±0.30 | 10.0% | | (II) |
| 16V | C3216X6S226MEPS | C3216X6S226MEP | 0.5V , 120Hz | 22 | uF | ±20% | 1.60 | ±0.20 | ±0.20 | 10.0% | Embossed, 2Kpcs | (II) |
| 10V | C3216X6S476MDPS | C3216X6S476MDP | 0.5V , 120Hz | 47 | uF | ±20% | 1.60 | ±0.30 | ±0.30 | 10.0% | Embossed, 2Kpcs | (II) |
| 6.3V | C3216X6S476MCPS | C3216X6S476MCP | 0.5V , 120Hz | 47 | uF | ±20% | 1.60 | ±0.20 | ±0.20 | 10.0% | Embossed, 2Kpcs | (II) |
| 4V | C3216X6S226MBTS | C3216X6S226MBT | 0.5V , 120Hz | 22 | uF | ±20% | 0.85 | ±0.20 | ±0.10 | 10.0% | Paper, 4Kpcs | (II) |
| | C3216X6S107MBPS | C3216X6S107MBP | 0.5V , 120Hz | 100 | uF | ±20% | 1.60 | ±0.20 | ±0.20 | 10.0% | Embossed, 2Kpcs | (II) |

● C3225X6S Series (EIA1210)

| RV | DARFON P/N | DARFON P/N 2 | Measuring Condition | Capacitance | | Available Tolerance | Thick. (mm) | Tolerance(mm) | | DF (max.) | Standard Packing | Test Spec. |
|------|-----------------|----------------|---------------------|-------------|------|---------------------|-------------|---------------|--------|-----------|------------------|------------|
| | | | | Value | Unit | | | L/W | Thick. | | | |
| 16V | C3225X6S476MEPS | C3225X6S476MEP | 0.5V , 120Hz | 47 | uF | ±20% | 2.50 | ±0.30 | ±0.20 | 10.0% | Embossed, 1Kpcs | (II)* |
| 6.3V | C3225X6S107MCPS | C3225X6S107MCP | 0.5V , 120Hz | 100 | uF | ±20% | 2.50 | ±0.30 | ±0.30 | 10.0% | Embossed, 1Kpcs | (II) |

□ Tolerance Code: K=±10%, M=±20% ;Special tolerance on the request.;

(II)* High temperature load life test are applicable in rated voltage *100%

- X7R Series
- C0603X7R Series(EIA0201)

| RV | DARFON P/N | DARFON P/N 2 | Measuring Condition | Capacitance | | Available Tolerance | Thick. (mm) | Tolerance(mm) | | DF (max.) | Standard Packing | Test Spec. |
|-------------------|-------------------|----------------|---------------------|-------------|------|---------------------|-------------|---------------|--------|-----------|------------------|------------|
| | | | | Value | Unit | | | L/W | Thick. | | | |
| 50V | C0603X7R101□GTS | C0603X7R101□GT | 1V, 1kHz | 100 | pF | ±10%, ±5% | 0.30 | ±0.03 | ±0.03 | 3.0% | Paper, 15Kpcs | (I) |
| | C0603X7R121KGTS | C0603X7R121KGT | 1V, 1kHz | 120 | pF | ±10% | 0.30 | ±0.03 | ±0.03 | 3.0% | | (I) |
| | C0603X7R151KGTS | C0603X7R151KGT | 1V, 1kHz | 150 | pF | ±10% | 0.30 | ±0.03 | ±0.03 | 3.0% | | (I) |
| | C0603X7R181KGTS | C0603X7R181KGT | 1V, 1kHz | 180 | pF | ±10% | 0.30 | ±0.03 | ±0.03 | 3.0% | | (I) |
| | C0603X7R221□GTS | C0603X7R221□GT | 1V, 1kHz | 220 | pF | ±10%, ±5% | 0.30 | ±0.03 | ±0.03 | 3.0% | | (I) |
| | C0603X7R271KGTS | C0603X7R271KGT | 1V, 1kHz | 270 | pF | ±10% | 0.30 | ±0.03 | ±0.03 | 3.0% | | (I) |
| | C0603X7R331KGTS | C0603X7R331KGT | 1V, 1kHz | 330 | pF | ±10% | 0.30 | ±0.03 | ±0.03 | 3.0% | | (I) |
| | C0603X7R391KGTS | C0603X7R391KGT | 1V, 1kHz | 390 | pF | ±10% | 0.30 | ±0.03 | ±0.03 | 3.0% | | (I) |
| | C0603X7R471KGTS | C0603X7R471KGT | 1V, 1kHz | 470 | pF | ±10% | 0.30 | ±0.03 | ±0.03 | 3.0% | | (I) |
| | C0603X7R561KGTS | C0603X7R561KGT | 1V, 1kHz | 560 | pF | ±10% | 0.30 | ±0.03 | ±0.03 | 3.0% | | (I) |
| | C0603X7R681□GTS | C0603X7R681□GT | 1V, 1kHz | 680 | pF | ±10%, ±5% | 0.30 | ±0.03 | ±0.03 | 3.0% | | (I) |
| | C0603X7R821KGTS | C0603X7R821KGT | 1V, 1kHz | 820 | pF | ±10% | 0.30 | ±0.03 | ±0.03 | 3.0% | | (I) |
| | C0603X7R102KGTS | C0603X7R102KGT | 1V, 1kHz | 1.0 | nF | ±10% | 0.30 | ±0.03 | ±0.03 | 3.0% | | (I) |
| | C0603X7R122KGTS | C0603X7R122KGT | 1V, 1kHz | 1.2 | nF | ±10% | 0.30 | ±0.03 | ±0.03 | 3.0% | | (I) |
| | C0603X7R152KGTS | C0603X7R152KGT | 1V, 1kHz | 1.5 | nF | ±10% | 0.30 | ±0.03 | ±0.03 | 3.0% | | (I) |
| C0603X7R182KGTS | C0603X7R182KGT | 1V, 1kHz | 1.8 | nF | ±10% | 0.30 | ±0.03 | ±0.03 | 3.0% | (I) | | |
| C0603X7R222KGTS | C0603X7R222KGT | 1V, 1kHz | 2.2 | nF | ±10% | 0.30 | ±0.03 | ±0.03 | 3.0% | (I) | | |
| 25V | C0603X7R101KFSTS | C0603X7R101KFT | 1V, 1kHz | 100 | pF | ±10% | 0.30 | ±0.03 | ±0.03 | 3.5% | Paper, 15Kpcs | (I) |
| | C0603X7R121KFSTS | C0603X7R121KFT | 1V, 1kHz | 120 | pF | ±10% | 0.30 | ±0.03 | ±0.03 | 3.5% | | (I) |
| | C0603X7R151KFSTS | C0603X7R151KFT | 1V, 1kHz | 150 | pF | ±10% | 0.30 | ±0.03 | ±0.03 | 3.5% | | (I) |
| | C0603X7R181KFSTS | C0603X7R181KFT | 1V, 1kHz | 180 | pF | ±10% | 0.30 | ±0.03 | ±0.03 | 3.5% | | (I) |
| | C0603X7R221KFSTS | C0603X7R221KFT | 1V, 1kHz | 220 | pF | ±10% | 0.30 | ±0.03 | ±0.03 | 3.5% | | (I) |
| | C0603X7R271KFSTS | C0603X7R271KFT | 1V, 1kHz | 270 | pF | ±10% | 0.30 | ±0.03 | ±0.03 | 3.5% | | (I) |
| | C0603X7R331KFSTS | C0603X7R331KFT | 1V, 1kHz | 330 | pF | ±10% | 0.30 | ±0.03 | ±0.03 | 3.5% | | (I) |
| | C0603X7R391KFSTS | C0603X7R391KFT | 1V, 1kHz | 390 | pF | ±10% | 0.30 | ±0.03 | ±0.03 | 3.5% | | (I) |
| | C0603X7R471□FSTS | C0603X7R471□FT | 1V, 1kHz | 470 | pF | ±10%, ±5% | 0.30 | ±0.03 | ±0.03 | 3.5% | | (I) |
| | C0603X7R561KFSTS | C0603X7R561KFT | 1V, 1kHz | 560 | pF | ±10% | 0.30 | ±0.03 | ±0.03 | 3.5% | | (I) |
| | C0603X7R681KFSTS | C0603X7R681KFT | 1V, 1kHz | 680 | pF | ±10% | 0.30 | ±0.03 | ±0.03 | 3.5% | | (I) |
| | C0603X7R821KFSTS | C0603X7R821KFT | 1V, 1kHz | 820 | pF | ±10% | 0.30 | ±0.03 | ±0.03 | 3.5% | | (I) |
| | C0603X7R102KFSTS | C0603X7R102KFT | 1V, 1kHz | 1.0 | nF | ±10% | 0.30 | ±0.03 | ±0.03 | 3.5% | | (I) |
| | C0603X7R122KFSTS | C0603X7R122KFT | 1V, 1kHz | 1.2 | nF | ±10% | 0.30 | ±0.03 | ±0.03 | 3.5% | | (I) |
| | C0603X7R152KFSTS | C0603X7R152KFT | 1V, 1kHz | 1.5 | nF | ±10% | 0.30 | ±0.03 | ±0.03 | 3.5% | | (I) |
| C0603X7R182KFSTS | C0603X7R182KFT | 1V, 1kHz | 1.8 | nF | ±10% | 0.30 | ±0.03 | ±0.03 | 3.5% | (I) | | |
| C0603X7R222KFSTS | C0603X7R222KFT | 1V, 1kHz | 2.2 | nF | ±10% | 0.30 | ±0.03 | ±0.03 | 3.5% | (I) | | |
| C0603X7R332KFSTS | C0603X7R332KFT | 1V, 1kHz | 3.3 | nF | ±10% | 0.30 | ±0.03 | ±0.03 | 5.0% | (I) | | |
| C0603X7R682KFSTS | C0603X7R682KFT | 1V, 1kHz | 6.8 | nF | ±10% | 0.30 | ±0.03 | ±0.03 | 5.0% | (I) | | |
| C0603X7R103KFSTS | C0603X7R103KFT | 1V, 1kHz | 10 | nF | ±10% | 0.30 | ±0.03 | ±0.03 | 5.0% | (I) | | |
| 16V | C0603X7R101KETSTS | C0603X7R101KET | 1V, 1kHz | 100 | pF | ±10% | 0.30 | ±0.03 | ±0.03 | 3.5% | Paper, 15Kpcs | (I) |
| | C0603X7R221KETSTS | C0603X7R221KET | 1V, 1kHz | 220 | pF | ±10% | 0.30 | ±0.03 | ±0.03 | 3.5% | | (I) |
| | C0603X7R331KETSTS | C0603X7R331KET | 1V, 1kHz | 330 | pF | ±10% | 0.30 | ±0.03 | ±0.03 | 3.5% | | (I) |
| | C0603X7R471KETSTS | C0603X7R471KET | 1V, 1kHz | 470 | pF | ±10% | 0.30 | ±0.03 | ±0.03 | 3.5% | | (I) |
| | C0603X7R681□ETS | C0603X7R681□ET | 1V, 1kHz | 680 | pF | ±10%, ±5% | 0.30 | ±0.03 | ±0.03 | 3.5% | | (I) |
| | C0603X7R821□ETS | C0603X7R821□ET | 1V, 1kHz | 820 | pF | ±10%, ±5% | 0.30 | ±0.03 | ±0.03 | 3.5% | | (I) |
| | C0603X7R102□ETS | C0603X7R102□ET | 1V, 1kHz | 1.0 | nF | ±10%, ±5% | 0.30 | ±0.03 | ±0.03 | 3.5% | | (I) |
| | C0603X7R152□ETS | C0603X7R152□ET | 1V, 1kHz | 1.5 | nF | ±10%, ±5% | 0.30 | ±0.03 | ±0.03 | 3.5% | | (I) |
| | C0603X7R222KETSTS | C0603X7R222KET | 1V, 1kHz | 2.2 | nF | ±10% | 0.30 | ±0.03 | ±0.03 | 3.5% | | (I) |
| | C0603X7R272□ETS | C0603X7R272□ET | 1V, 1kHz | 2.7 | nF | ±10%, ±5% | 0.30 | ±0.03 | ±0.03 | 5.0% | | (I) |
| | C0603X7R332KETSTS | C0603X7R332KET | 1V, 1kHz | 3.3 | nF | ±10% | 0.30 | ±0.03 | ±0.03 | 5.0% | | (I) |
| | C0603X7R392KETSTS | C0603X7R392KET | 1V, 1kHz | 3.9 | nF | ±10% | 0.30 | ±0.03 | ±0.03 | 5.0% | | (I) |
| | C0603X7R472KETSTS | C0603X7R472KET | 1V, 1kHz | 4.7 | nF | ±10% | 0.30 | ±0.03 | ±0.03 | 5.0% | | (I) |
| | C0603X7R562KETSTS | C0603X7R562KET | 1V, 1kHz | 5.6 | nF | ±10% | 0.30 | ±0.03 | ±0.03 | 5.0% | | (I) |
| | C0603X7R682KETSTS | C0603X7R682KET | 1V, 1kHz | 6.8 | nF | ±10% | 0.30 | ±0.03 | ±0.03 | 5.0% | | (I) |
| C0603X7R822KETSTS | C0603X7R822KET | 1V, 1kHz | 8.2 | nF | ±10% | 0.30 | ±0.03 | ±0.03 | 5.0% | (I) | | |
| C0603X7R103KETSTS | C0603X7R103KET | 1V, 1kHz | 10 | nF | ±10% | 0.30 | ±0.03 | ±0.03 | 5.0% | (I) | | |
| 10V | C0603X7R182KDSTS | C0603X7R182KDT | 1V, 1kHz | 1.8 | nF | ±10% | 0.30 | ±0.03 | ±0.03 | 5.0% | Paper, 15Kpcs | (I) |
| | C0603X7R222KDSTS | C0603X7R222KDT | 1V, 1kHz | 2.2 | nF | ±10% | 0.30 | ±0.03 | ±0.03 | 5.0% | | (I) |
| | C0603X7R272□DSTS | C0603X7R272□DT | 1V, 1kHz | 2.7 | nF | ±10%, ±5% | 0.30 | ±0.03 | ±0.03 | 5.0% | | (I) |
| | C0603X7R332KDSTS | C0603X7R332KDT | 1V, 1kHz | 3.3 | nF | ±10% | 0.30 | ±0.03 | ±0.03 | 5.0% | | (I) |
| | C0603X7R392KDSTS | C0603X7R392KDT | 1V, 1kHz | 3.9 | nF | ±10% | 0.30 | ±0.03 | ±0.03 | 5.0% | | (I) |
| | C0603X7R472KDSTS | C0603X7R472KDT | 1V, 1kHz | 4.7 | nF | ±10% | 0.30 | ±0.03 | ±0.03 | 5.0% | | (I) |
| | C0603X7R562KDSTS | C0603X7R562KDT | 1V, 1kHz | 5.6 | nF | ±10% | 0.30 | ±0.03 | ±0.03 | 5.0% | | (I) |
| | C0603X7R682KDSTS | C0603X7R682KDT | 1V, 1kHz | 6.8 | nF | ±10% | 0.30 | ±0.03 | ±0.03 | 5.0% | | (I) |
| C0603X7R822KDSTS | C0603X7R822KDT | 1V, 1kHz | 8.2 | nF | ±10% | 0.30 | ±0.03 | ±0.03 | 5.0% | (I) | | |
| C0603X7R103KDSTS | C0603X7R103KDT | 1V, 1kHz | 10 | nF | ±10% | 0.30 | ±0.03 | ±0.03 | 5.0% | (I) | | |
| 6.3V | C0603X7R103KCTSTS | C0603X7R103KCT | 1V, 1kHz | 10 | nF | ±10% | 0.30 | ±0.03 | ±0.03 | 5.0% | Paper, 15Kpcs | (I) |

□ Tolerance Code: J=±5%, K=±10%, M=±20%; Special tolerance on the request.

● C1005X7R Series (EIA0402)

| RV | DARFON P/N | DARFON P/N 2 | Measuring Condition | Capacitance | | Available Tolerance | Thick. (mm) | Tolerance(mm) | | DF (max.) | Standard Packing | Test Spec. |
|-----------------|-----------------|----------------|---------------------|-------------|------|---------------------|-------------|---------------|--------|-----------|------------------|------------|
| | | | | Value | Unit | | | L/W | Thick. | | | |
| 50V | C1005X7R101□GTS | C1005X7R101□GT | 1V, 1kHz | 100 | pF | ±10%, ±5% | 0.50 | ±0.05 | ±0.05 | 3.0% | Paper, 10Kpcs | (I) |
| | C1005X7R121KGT | C1005X7R121KGT | 1V, 1kHz | 120 | pF | ±10% | 0.50 | ±0.05 | ±0.05 | 3.0% | | (I) |
| | C1005X7R151KGT | C1005X7R151KGT | 1V, 1kHz | 150 | pF | ±10% | 0.50 | ±0.05 | ±0.05 | 3.0% | | (I) |
| | C1005X7R181KGT | C1005X7R181KGT | 1V, 1kHz | 180 | pF | ±10% | 0.50 | ±0.05 | ±0.05 | 3.0% | | (I) |
| | C1005X7R221KGT | C1005X7R221KGT | 1V, 1kHz | 220 | pF | ±10% | 0.50 | ±0.05 | ±0.05 | 3.0% | | (I) |
| | C1005X7R271KGT | C1005X7R271KGT | 1V, 1kHz | 270 | pF | ±10% | 0.50 | ±0.05 | ±0.05 | 3.0% | | (I) |
| | C1005X7R331KGT | C1005X7R331KGT | 1V, 1kHz | 330 | pF | ±10% | 0.50 | ±0.05 | ±0.05 | 3.0% | | (I) |
| | C1005X7R391KGT | C1005X7R391KGT | 1V, 1kHz | 390 | pF | ±10% | 0.50 | ±0.05 | ±0.05 | 3.0% | | (I) |
| | C1005X7R471KGT | C1005X7R471KGT | 1V, 1kHz | 470 | pF | ±10% | 0.50 | ±0.05 | ±0.05 | 3.0% | | (I) |
| | C1005X7R561KGT | C1005X7R561KGT | 1V, 1kHz | 560 | pF | ±10% | 0.50 | ±0.05 | ±0.05 | 3.0% | | (I) |
| | C1005X7R681KGT | C1005X7R681KGT | 1V, 1kHz | 680 | pF | ±10% | 0.50 | ±0.05 | ±0.05 | 3.0% | | (I) |
| | C1005X7R751KGT | C1005X7R751KGT | 1V, 1kHz | 750 | pF | ±10% | 0.50 | ±0.05 | ±0.05 | 3.0% | | (I) |
| | C1005X7R821KGT | C1005X7R821KGT | 1V, 1kHz | 820 | pF | ±10% | 0.50 | ±0.05 | ±0.05 | 3.0% | | (I) |
| | C1005X7R102□GTS | C1005X7R102□GT | 1V, 1kHz | 1.0 | nF | ±10%, ±5% | 0.50 | ±0.05 | ±0.05 | 3.0% | | (I) |
| | C1005X7R122KGT | C1005X7R122KGT | 1V, 1kHz | 1.2 | nF | ±10% | 0.50 | ±0.05 | ±0.05 | 3.0% | | (I) |
| | C1005X7R152KGT | C1005X7R152KGT | 1V, 1kHz | 1.5 | nF | ±10% | 0.50 | ±0.05 | ±0.05 | 3.0% | | (I) |
| | C1005X7R182KGT | C1005X7R182KGT | 1V, 1kHz | 1.8 | nF | ±10% | 0.50 | ±0.05 | ±0.05 | 3.0% | | (I) |
| | C1005X7R222□GTS | C1005X7R222□GT | 1V, 1kHz | 2.2 | nF | ±10%, ±5% | 0.50 | ±0.05 | ±0.05 | 3.0% | | (I) |
| | C1005X7R272□GTS | C1005X7R272□GT | 1V, 1kHz | 2.7 | nF | ±10%, ±5% | 0.50 | ±0.05 | ±0.05 | 3.0% | | (I) |
| | C1005X7R332□GTS | C1005X7R332□GT | 1V, 1kHz | 3.3 | nF | ±10%, ±5% | 0.50 | ±0.05 | ±0.05 | 3.0% | | (I) |
| | C1005X7R392KGT | C1005X7R392KGT | 1V, 1kHz | 3.9 | nF | ±10% | 0.50 | ±0.05 | ±0.05 | 3.0% | | (I) |
| | C1005X7R472KGT | C1005X7R472KGT | 1V, 1kHz | 4.7 | nF | ±10% | 0.50 | ±0.05 | ±0.05 | 3.0% | | (I) |
| | C1005X7R562KGT | C1005X7R562KGT | 1V, 1kHz | 5.6 | nF | ±10% | 0.50 | ±0.05 | ±0.05 | 3.0% | | (I) |
| | C1005X7R682KGT | C1005X7R682KGT | 1V, 1kHz | 6.8 | nF | ±10% | 0.50 | ±0.05 | ±0.05 | 3.0% | | (I) |
| | C1005X7R822KGT | C1005X7R822KGT | 1V, 1kHz | 8.2 | nF | ±10% | 0.50 | ±0.05 | ±0.05 | 3.0% | | (I) |
| | C1005X7R103KGT | C1005X7R103KGT | 1V, 1kHz | 10 | nF | ±10% | 0.50 | ±0.05 | ±0.05 | 3.0% | | (I) |
| | C1005X7R123KGT | C1005X7R123KGT | 1V, 1kHz | 12 | nF | ±10% | 0.50 | ±0.05 | ±0.05 | 3.0% | | (I) |
| | C1005X7R153KGT | C1005X7R153KGT | 1V, 1kHz | 15 | nF | ±10% | 0.50 | ±0.05 | ±0.05 | 3.0% | | (I) |
| | C1005X7R223KGT | C1005X7R223KGT | 1V, 1kHz | 22 | nF | ±10% | 0.50 | ±0.05 | ±0.05 | 3.0% | | (I) |
| | C1005X7R333KGT | C1005X7R333KGT | 1V, 1kHz | 33 | nF | ±10% | 0.50 | ±0.05 | ±0.05 | 3.5% | | (I) |
| C1005X7R473KGT | C1005X7R473KGT | 1V, 1kHz | 47 | nF | ±10% | 0.50 | ±0.05 | ±0.05 | 10.0% | (II) | | |
| C1005X7R104KGT | C1005X7R104KGT | 1V, 1kHz | 100 | nF | ±10% | 0.50 | ±0.10 | ±0.10 | 10.0% | (II) | | |
| 25V | C1005X7R101KFST | C1005X7R101KFT | 1V, 1kHz | 100 | pF | ±10% | 0.50 | ±0.05 | ±0.05 | 3.0% | Paper, 10Kpcs | (I) |
| | C1005X7R121KFST | C1005X7R121KFT | 1V, 1kHz | 120 | pF | ±10% | 0.50 | ±0.05 | ±0.05 | 3.0% | | (I) |
| | C1005X7R151KFST | C1005X7R151KFT | 1V, 1kHz | 150 | pF | ±10% | 0.50 | ±0.05 | ±0.05 | 3.0% | | (I) |
| | C1005X7R181KFST | C1005X7R181KFT | 1V, 1kHz | 180 | pF | ±10% | 0.50 | ±0.05 | ±0.05 | 3.0% | | (I) |
| | C1005X7R221KFST | C1005X7R221KFT | 1V, 1kHz | 220 | pF | ±10% | 0.50 | ±0.05 | ±0.05 | 3.0% | | (I) |
| | C1005X7R271KFST | C1005X7R271KFT | 1V, 1kHz | 270 | pF | ±10% | 0.50 | ±0.05 | ±0.05 | 3.0% | | (I) |
| | C1005X7R331KFST | C1005X7R331KFT | 1V, 1kHz | 330 | pF | ±10% | 0.50 | ±0.05 | ±0.05 | 3.0% | | (I) |
| | C1005X7R391KFST | C1005X7R391KFT | 1V, 1kHz | 390 | pF | ±10% | 0.50 | ±0.05 | ±0.05 | 3.0% | | (I) |
| | C1005X7R471KFST | C1005X7R471KFT | 1V, 1kHz | 470 | pF | ±10% | 0.50 | ±0.05 | ±0.05 | 3.0% | | (I) |
| | C1005X7R561KFST | C1005X7R561KFT | 1V, 1kHz | 560 | pF | ±10% | 0.50 | ±0.05 | ±0.05 | 3.0% | | (I) |
| | C1005X7R681KFST | C1005X7R681KFT | 1V, 1kHz | 680 | pF | ±10% | 0.50 | ±0.05 | ±0.05 | 3.0% | | (I) |
| | C1005X7R821KFST | C1005X7R821KFT | 1V, 1kHz | 820 | pF | ±10% | 0.50 | ±0.05 | ±0.05 | 3.0% | | (I) |
| | C1005X7R102KFST | C1005X7R102KFT | 1V, 1kHz | 1.0 | nF | ±10% | 0.50 | ±0.05 | ±0.05 | 3.0% | | (I) |
| | C1005X7R122KFST | C1005X7R122KFT | 1V, 1kHz | 1.2 | nF | ±10% | 0.50 | ±0.05 | ±0.05 | 3.0% | | (I) |
| | C1005X7R152KFST | C1005X7R152KFT | 1V, 1kHz | 1.5 | nF | ±10% | 0.50 | ±0.05 | ±0.05 | 3.0% | | (I) |
| | C1005X7R182KFST | C1005X7R182KFT | 1V, 1kHz | 1.8 | nF | ±10% | 0.50 | ±0.05 | ±0.05 | 3.0% | | (I) |
| | C1005X7R222KFST | C1005X7R222KFT | 1V, 1kHz | 2.2 | nF | ±10% | 0.50 | ±0.05 | ±0.05 | 3.0% | | (I) |
| | C1005X7R272KFST | C1005X7R272KFT | 1V, 1kHz | 2.7 | nF | ±10% | 0.50 | ±0.05 | ±0.05 | 3.0% | | (I) |
| | C1005X7R332□FST | C1005X7R332□FT | 1V, 1kHz | 3.3 | nF | ±10%, ±5% | 0.50 | ±0.05 | ±0.05 | 3.0% | | (I) |
| | C1005X7R392KFST | C1005X7R392KFT | 1V, 1kHz | 3.9 | nF | ±10% | 0.50 | ±0.05 | ±0.05 | 3.0% | | (I) |
| | C1005X7R472KFST | C1005X7R472KFT | 1V, 1kHz | 4.7 | nF | ±10% | 0.50 | ±0.05 | ±0.05 | 3.0% | | (I) |
| | C1005X7R562KFST | C1005X7R562KFT | 1V, 1kHz | 5.6 | nF | ±10% | 0.50 | ±0.05 | ±0.05 | 3.0% | | (I) |
| | C1005X7R682KFST | C1005X7R682KFT | 1V, 1kHz | 6.8 | nF | ±10% | 0.50 | ±0.05 | ±0.05 | 3.0% | | (I) |
| | C1005X7R822KFST | C1005X7R822KFT | 1V, 1kHz | 8.2 | nF | ±10% | 0.50 | ±0.05 | ±0.05 | 3.0% | | (I) |
| | C1005X7R103□FST | C1005X7R103□FT | 1V, 1kHz | 10 | nF | ±10%, ±5% | 0.50 | ±0.05 | ±0.05 | 3.0% | | (I) |
| | C1005X7R123KFST | C1005X7R123KFT | 1V, 1kHz | 12 | nF | ±10% | 0.50 | ±0.05 | ±0.05 | 3.0% | | (I) |
| | C1005X7R153□FST | C1005X7R153□FT | 1V, 1kHz | 15 | nF | ±10%, ±5% | 0.50 | ±0.05 | ±0.05 | 3.0% | | (I) |
| | C1005X7R183KFST | C1005X7R183KFT | 1V, 1kHz | 18 | nF | ±10% | 0.50 | ±0.05 | ±0.05 | 3.0% | | (I) |
| | C1005X7R223□FST | C1005X7R223□FT | 1V, 1kHz | 22 | nF | ±10%, ±5% | 0.50 | ±0.05 | ±0.05 | 3.0% | | (I) |
| | C1005X7R273KFST | C1005X7R273KFT | 1V, 1kHz | 27 | nF | ±10% | 0.50 | ±0.05 | ±0.05 | 3.5% | | (I) |
| C1005X7R333KFST | C1005X7R333KFT | 1V, 1kHz | 33 | nF | ±10% | 0.50 | ±0.05 | ±0.05 | 3.5% | (I) | | |
| C1005X7R473KFST | C1005X7R473KFT | 1V, 1kHz | 47 | nF | ±10% | 0.50 | ±0.05 | ±0.05 | 3.5% | (I) | | |
| C1005X7R563KFST | C1005X7R563KFT | 1V, 1kHz | 56 | nF | ±10% | 0.50 | ±0.05 | ±0.05 | 3.5% | (I) | | |
| C1005X7R683KFST | C1005X7R683KFT | 1V, 1kHz | 68 | nF | ±10% | 0.50 | ±0.05 | ±0.05 | 3.5% | (I) | | |
| C1005X7R104KFST | C1005X7R104KFT | 1V, 1kHz | 100 | nF | ±10% | 0.50 | ±0.05 | ±0.05 | 10.0% | (II) | | |
| C1005X7R224KFST | C1005X7R224KFT | 1V, 1kHz | 220 | nF | ±10% | 0.50 | ±0.05 | ±0.05 | 10.0% | (II) | | |
| 16V | C1005X7R101KETS | C1005X7R101KET | 1V, 1kHz | 100 | pF | ±10% | 0.50 | ±0.05 | ±0.05 | 5.0% | Paper, 10Kpcs | (I) |
| | C1005X7R121KETS | C1005X7R121KET | 1V, 1kHz | 120 | pF | ±10% | 0.50 | ±0.05 | ±0.05 | 5.0% | | (I) |
| | C1005X7R151KETS | C1005X7R151KET | 1V, 1kHz | 150 | pF | ±10% | 0.50 | ±0.05 | ±0.05 | 5.0% | | (I) |
| | C1005X7R181KETS | C1005X7R181KET | 1V, 1kHz | 180 | pF | ±10% | 0.50 | ±0.05 | ±0.05 | 5.0% | | (I) |
| | C1005X7R221KETS | C1005X7R221KET | 1V, 1kHz | 220 | pF | ±10% | 0.50 | ±0.05 | ±0.05 | 5.0% | | (I) |

| RV | DARFON P/N | DARFON P/N 2 | Measuring Condition | Capacitance | | Available Tolerance | Thick. (mm) | Tolerance(mm) | | DF (max.) | Standard Packing | Test Spec. |
|-----------------|-----------------|----------------|---------------------|-------------|-----------|---------------------|-------------|---------------|--------|-----------|------------------|------------|
| | | | | Value | Unit | | | L/W | Thick. | | | |
| 16V | C1005X7R271KETS | C1005X7R271KET | 1V, 1kHz | 270 | pF | ±10% | 0.50 | ±0.05 | ±0.05 | 5.0% | Paper, 10Kpcs | (I) |
| | C1005X7R331KETS | C1005X7R331KET | 1V, 1kHz | 330 | pF | ±10% | 0.50 | ±0.05 | ±0.05 | 5.0% | | (I) |
| | C1005X7R391KETS | C1005X7R391KET | 1V, 1kHz | 390 | pF | ±10% | 0.50 | ±0.05 | ±0.05 | 5.0% | | (I) |
| | C1005X7R471KETS | C1005X7R471KET | 1V, 1kHz | 470 | pF | ±10% | 0.50 | ±0.05 | ±0.05 | 5.0% | | (I) |
| | C1005X7R561KETS | C1005X7R561KET | 1V, 1kHz | 560 | pF | ±10% | 0.50 | ±0.05 | ±0.05 | 5.0% | | (I) |
| | C1005X7R681KETS | C1005X7R681KET | 1V, 1kHz | 680 | pF | ±10% | 0.50 | ±0.05 | ±0.05 | 5.0% | | (I) |
| | C1005X7R821KETS | C1005X7R821KET | 1V, 1kHz | 820 | pF | ±10% | 0.50 | ±0.05 | ±0.05 | 5.0% | | (I) |
| | C1005X7R102KETS | C1005X7R102KET | 1V, 1kHz | 1.0 | nF | ±10% | 0.50 | ±0.05 | ±0.05 | 5.0% | | (I) |
| | C1005X7R122KETS | C1005X7R122KET | 1V, 1kHz | 1.2 | nF | ±10% | 0.50 | ±0.05 | ±0.05 | 5.0% | | (I) |
| | C1005X7R152KETS | C1005X7R152KET | 1V, 1kHz | 1.5 | nF | ±10% | 0.50 | ±0.05 | ±0.05 | 5.0% | | (I) |
| | C1005X7R182KETS | C1005X7R182KET | 1V, 1kHz | 1.8 | nF | ±10% | 0.50 | ±0.05 | ±0.05 | 5.0% | | (I) |
| | C1005X7R222KETS | C1005X7R222KET | 1V, 1kHz | 2.2 | nF | ±10% | 0.50 | ±0.05 | ±0.05 | 5.0% | | (I) |
| | C1005X7R272KETS | C1005X7R272KET | 1V, 1kHz | 2.7 | nF | ±10% | 0.50 | ±0.05 | ±0.05 | 5.0% | | (I) |
| | C1005X7R332KETS | C1005X7R332KET | 1V, 1kHz | 3.3 | nF | ±10% | 0.50 | ±0.05 | ±0.05 | 5.0% | | (I) |
| | C1005X7R392KETS | C1005X7R392KET | 1V, 1kHz | 3.9 | nF | ±10% | 0.50 | ±0.05 | ±0.05 | 5.0% | | (I) |
| | C1005X7R472KETS | C1005X7R472KET | 1V, 1kHz | 4.7 | nF | ±10% | 0.50 | ±0.05 | ±0.05 | 5.0% | | (I) |
| | C1005X7R562KETS | C1005X7R562KET | 1V, 1kHz | 5.6 | nF | ±10% | 0.50 | ±0.05 | ±0.05 | 5.0% | | (I) |
| | C1005X7R682KETS | C1005X7R682KET | 1V, 1kHz | 6.8 | nF | ±10% | 0.50 | ±0.05 | ±0.05 | 5.0% | | (I) |
| | C1005X7R822KETS | C1005X7R822KET | 1V, 1kHz | 8.2 | nF | ±10% | 0.50 | ±0.05 | ±0.05 | 5.0% | | (I) |
| | C1005X7R103KETS | C1005X7R103KET | 1V, 1kHz | 10 | nF | ±10% | 0.50 | ±0.05 | ±0.05 | 5.0% | | (I) |
| | C1005X7R123KETS | C1005X7R123KET | 1V, 1kHz | 12 | nF | ±10% | 0.50 | ±0.05 | ±0.05 | 5.0% | | (I) |
| | C1005X7R153KETS | C1005X7R153KET | 1V, 1kHz | 15 | nF | ±10% | 0.50 | ±0.05 | ±0.05 | 5.0% | | (I) |
| | C1005X7R183KETS | C1005X7R183KET | 1V, 1kHz | 18 | nF | ±10% | 0.50 | ±0.05 | ±0.05 | 5.0% | | (I) |
| | C1005X7R223KETS | C1005X7R223KET | 1V, 1kHz | 22 | nF | ±10% | 0.50 | ±0.05 | ±0.05 | 5.0% | | (I) |
| | C1005X7R273KETS | C1005X7R273KET | 1V, 1kHz | 27 | nF | ±10% | 0.50 | ±0.05 | ±0.05 | 5.0% | | (I) |
| | C1005X7R333KETS | C1005X7R333KET | 1V, 1kHz | 33 | nF | ±10% | 0.50 | ±0.05 | ±0.05 | 5.0% | | (I) |
| | C1005X7R393KETS | C1005X7R393KET | 1V, 1kHz | 39 | nF | ±10% | 0.50 | ±0.05 | ±0.05 | 5.0% | | (I) |
| | C1005X7R473KETS | C1005X7R473KET | 1V, 1kHz | 47 | nF | ±10% | 0.50 | ±0.05 | ±0.05 | 5.0% | | (I) |
| | C1005X7R563KETS | C1005X7R563KET | 1V, 1kHz | 56 | nF | ±10% | 0.50 | ±0.05 | ±0.05 | 5.0% | | (I) |
| | C1005X7R683KETS | C1005X7R683KET | 1V, 1kHz | 68 | nF | ±10% | 0.50 | ±0.05 | ±0.05 | 5.0% | | (I) |
| | C1005X7R823KETS | C1005X7R823KET | 1V, 1kHz | 82 | nF | ±10% | 0.50 | ±0.05 | ±0.05 | 5.0% | | (I) |
| | C1005X7R104□ETS | C1005X7R104□ET | 1V, 1kHz | 100 | nF | ±10%, ±20% | 0.50 | ±0.05 | ±0.05 | 5.0% | | (I) |
| | C1005X7R154KETS | C1005X7R154KET | 1V, 1kHz | 150 | nF | ±10% | 0.50 | ±0.05 | ±0.05 | 10.0% | | (II) |
| C1005X7R224KETS | C1005X7R224KET | 1V, 1kHz | 220 | nF | ±10% | 0.50 | ±0.05 | ±0.05 | 10.0% | (II) | | |
| 10V | C1005X7R101KDTS | C1005X7R101KDT | 1V, 1kHz | 100 | pF | ±10% | 0.50 | ±0.05 | ±0.05 | 5.0% | Paper, 10Kpcs | (I) |
| | C1005X7R121KDTS | C1005X7R121KDT | 1V, 1kHz | 120 | pF | ±10% | 0.50 | ±0.05 | ±0.05 | 5.0% | | (I) |
| | C1005X7R151KDTS | C1005X7R151KDT | 1V, 1kHz | 150 | pF | ±10% | 0.50 | ±0.05 | ±0.05 | 5.0% | | (I) |
| | C1005X7R181KDTS | C1005X7R181KDT | 1V, 1kHz | 180 | pF | ±10% | 0.50 | ±0.05 | ±0.05 | 5.0% | | (I) |
| | C1005X7R221KDTS | C1005X7R221KDT | 1V, 1kHz | 220 | pF | ±10% | 0.50 | ±0.05 | ±0.05 | 5.0% | | (I) |
| | C1005X7R271KDTS | C1005X7R271KDT | 1V, 1kHz | 270 | pF | ±10% | 0.50 | ±0.05 | ±0.05 | 5.0% | | (I) |
| | C1005X7R331KDTS | C1005X7R331KDT | 1V, 1kHz | 330 | pF | ±10% | 0.50 | ±0.05 | ±0.05 | 5.0% | | (I) |
| | C1005X7R391KDTS | C1005X7R391KDT | 1V, 1kHz | 390 | pF | ±10% | 0.50 | ±0.05 | ±0.05 | 5.0% | | (I) |
| | C1005X7R471KDTS | C1005X7R471KDT | 1V, 1kHz | 470 | pF | ±10% | 0.50 | ±0.05 | ±0.05 | 5.0% | | (I) |
| | C1005X7R561KDTS | C1005X7R561KDT | 1V, 1kHz | 560 | pF | ±10% | 0.50 | ±0.05 | ±0.05 | 5.0% | | (I) |
| | C1005X7R681KDTS | C1005X7R681KDT | 1V, 1kHz | 680 | pF | ±10% | 0.50 | ±0.05 | ±0.05 | 5.0% | | (I) |
| | C1005X7R821KDTS | C1005X7R821KDT | 1V, 1kHz | 820 | pF | ±10% | 0.50 | ±0.05 | ±0.05 | 5.0% | | (I) |
| | C1005X7R102KDTS | C1005X7R102KDT | 1V, 1kHz | 1.0 | nF | ±10% | 0.50 | ±0.05 | ±0.05 | 5.0% | | (I) |
| | C1005X7R122KDTS | C1005X7R122KDT | 1V, 1kHz | 1.2 | nF | ±10% | 0.50 | ±0.05 | ±0.05 | 5.0% | | (I) |
| | C1005X7R152KDTS | C1005X7R152KDT | 1V, 1kHz | 1.5 | nF | ±10% | 0.50 | ±0.05 | ±0.05 | 5.0% | | (I) |
| | C1005X7R182KDTS | C1005X7R182KDT | 1V, 1kHz | 1.8 | nF | ±10% | 0.50 | ±0.05 | ±0.05 | 5.0% | | (I) |
| | C1005X7R222KDTS | C1005X7R222KDT | 1V, 1kHz | 2.2 | nF | ±10% | 0.50 | ±0.05 | ±0.05 | 5.0% | | (I) |
| | C1005X7R272KDTS | C1005X7R272KDT | 1V, 1kHz | 2.7 | nF | ±10% | 0.50 | ±0.05 | ±0.05 | 5.0% | | (I) |
| | C1005X7R332KDTS | C1005X7R332KDT | 1V, 1kHz | 3.3 | nF | ±10% | 0.50 | ±0.05 | ±0.05 | 5.0% | | (I) |
| | C1005X7R392KDTS | C1005X7R392KDT | 1V, 1kHz | 3.9 | nF | ±10% | 0.50 | ±0.05 | ±0.05 | 5.0% | | (I) |
| | C1005X7R472KDTS | C1005X7R472KDT | 1V, 1kHz | 4.7 | nF | ±10% | 0.50 | ±0.05 | ±0.05 | 5.0% | | (I) |
| | C1005X7R562KDTS | C1005X7R562KDT | 1V, 1kHz | 5.6 | nF | ±10% | 0.50 | ±0.05 | ±0.05 | 5.0% | | (I) |
| | C1005X7R682KDTS | C1005X7R682KDT | 1V, 1kHz | 6.8 | nF | ±10% | 0.50 | ±0.05 | ±0.05 | 5.0% | | (I) |
| | C1005X7R822KDTS | C1005X7R822KDT | 1V, 1kHz | 8.2 | nF | ±10% | 0.50 | ±0.05 | ±0.05 | 5.0% | | (I) |
| | C1005X7R103KDTS | C1005X7R103KDT | 1V, 1kHz | 10 | nF | ±10% | 0.50 | ±0.05 | ±0.05 | 5.0% | | (I) |
| | C1005X7R123KDTS | C1005X7R123KDT | 1V, 1kHz | 12 | nF | ±10% | 0.50 | ±0.05 | ±0.05 | 5.0% | | (I) |
| | C1005X7R153KDTS | C1005X7R153KDT | 1V, 1kHz | 15 | nF | ±10% | 0.50 | ±0.05 | ±0.05 | 5.0% | | (I) |
| | C1005X7R183KDTS | C1005X7R183KDT | 1V, 1kHz | 18 | nF | ±10% | 0.50 | ±0.05 | ±0.05 | 5.0% | | (I) |
| | C1005X7R223KDTS | C1005X7R223KDT | 1V, 1kHz | 22 | nF | ±10% | 0.50 | ±0.05 | ±0.05 | 5.0% | | (I) |
| | C1005X7R273KDTS | C1005X7R273KDT | 1V, 1kHz | 27 | nF | ±10% | 0.50 | ±0.05 | ±0.05 | 5.0% | | (I) |
| | C1005X7R333KDTS | C1005X7R333KDT | 1V, 1kHz | 33 | nF | ±10% | 0.50 | ±0.05 | ±0.05 | 5.0% | | (I) |
| | C1005X7R393KDTS | C1005X7R393KDT | 1V, 1kHz | 39 | nF | ±10% | 0.50 | ±0.05 | ±0.05 | 5.0% | | (I) |
| | C1005X7R473KDTS | C1005X7R473KDT | 1V, 1kHz | 47 | nF | ±10% | 0.50 | ±0.05 | ±0.05 | 5.0% | | (I) |
| C1005X7R563KDTS | C1005X7R563KDT | 1V, 1kHz | 56 | nF | ±10% | 0.50 | ±0.05 | ±0.05 | 5.0% | (I) | | |
| C1005X7R683KDTS | C1005X7R683KDT | 1V, 1kHz | 68 | nF | ±10% | 0.50 | ±0.05 | ±0.05 | 5.0% | (I) | | |
| C1005X7R823KDTS | C1005X7R823KDT | 1V, 1kHz | 82 | nF | ±10% | 0.50 | ±0.05 | ±0.05 | 5.0% | (I) | | |
| C1005X7R104□DTS | C1005X7R104□DT | 1V, 1kHz | 100 | nF | ±10%, ±5% | 0.50 | ±0.05 | ±0.05 | 5.0% | (I) | | |
| C1005X7R224KDTS | C1005X7R224KDT | 1V, 1kHz | 220 | nF | ±10% | 0.50 | ±0.05 | ±0.05 | 10.0% | (II) | | |
| C1005X7R474KDTS | C1005X7R474KDT | 1V, 1kHz | 470 | nF | ±10% | 0.50 | ±0.05 | ±0.05 | 10.0% | (II) | | |
| 6.3V | C1005X7R103KCTS | C1005X7R103KCT | 1V, 1kHz | 10 | nF | ±10% | 0.50 | ±0.05 | ±0.05 | 5.0% | Paper, 10Kpcs | (I) |
| | C1005X7R473KCTS | C1005X7R473KCT | 1V, 1kHz | 47 | nF | ±10% | 0.50 | ±0.05 | ±0.05 | 5.0% | | (I) |
| | C1005X7R104KCTS | C1005X7R104KCT | 1V, 1kHz | 100 | nF | ±10% | 0.50 | ±0.05 | ±0.05 | 5.0% | | (I) |
| | C1005X7R474□CTS | C1005X7R474□CT | 1V, 1kHz | 470 | nF | ±10%, ±20% | 0.50 | ±0.05 | ±0.05 | 10.0% | | (II) |
| | C1005X7R105□CTS | C1005X7R105□CT | 1V, 1kHz | 1.0 | uF | ±10%, ±20% | 0.50 | ±0.05 | ±0.05 | 12.5% | | (III)* |

□ Tolerance Code: J=±5%, K=±10%, M=±20%.

● C1608X7R Series (EIA0603)

| RV | DARFON P/N | DARFON P/N 2 | Measuring Condition | Capacitance | | Available Tolerance | Thick. (mm) | Tolerance(mm) | | DF (max.) | Standard Packing | Test Spec. |
|-----------------|-----------------|----------------|---------------------|-------------|------|---------------------|-------------|---------------|--------|-----------|------------------|------------|
| | | | | Value | Unit | | | L/W | Thick. | | | |
| 50V | C1608X7R101KGTS | C1608X7R101KGT | 1V, 1kHz | 100 | pF | ±10% | 0.80 | ±0.10 | ±0.10 | 2.5% | Paper, 4Kpcs | (I) |
| | C1608X7R121KGTS | C1608X7R121KGT | 1V, 1kHz | 120 | pF | ±10% | 0.80 | ±0.10 | ±0.10 | 2.5% | | (I) |
| | C1608X7R151KGTS | C1608X7R151KGT | 1V, 1kHz | 150 | pF | ±10% | 0.80 | ±0.10 | ±0.10 | 2.5% | | (I) |
| | C1608X7R181KGTS | C1608X7R181KGT | 1V, 1kHz | 180 | pF | ±10% | 0.80 | ±0.10 | ±0.10 | 2.5% | | (I) |
| | C1608X7R221KGTS | C1608X7R221KGT | 1V, 1kHz | 220 | pF | ±10% | 0.80 | ±0.10 | ±0.10 | 2.5% | | (I) |
| | C1608X7R271KGTS | C1608X7R271KGT | 1V, 1kHz | 270 | pF | ±10% | 0.80 | ±0.10 | ±0.10 | 2.5% | | (I) |
| | C1608X7R331KGTS | C1608X7R331KGT | 1V, 1kHz | 330 | pF | ±10% | 0.80 | ±0.10 | ±0.10 | 2.5% | | (I) |
| | C1608X7R391KGTS | C1608X7R391KGT | 1V, 1kHz | 390 | pF | ±10% | 0.80 | ±0.10 | ±0.10 | 2.5% | | (I) |
| | C1608X7R471KGTS | C1608X7R471KGT | 1V, 1kHz | 470 | pF | ±10% | 0.80 | ±0.10 | ±0.10 | 2.5% | | (I) |
| | C1608X7R561KGTS | C1608X7R561KGT | 1V, 1kHz | 560 | pF | ±10% | 0.80 | ±0.10 | ±0.10 | 2.5% | | (I) |
| | C1608X7R681KGTS | C1608X7R681KGT | 1V, 1kHz | 680 | pF | ±10% | 0.80 | ±0.10 | ±0.10 | 2.5% | | (I) |
| | C1608X7R821KGTS | C1608X7R821KGT | 1V, 1kHz | 820 | pF | ±10% | 0.80 | ±0.10 | ±0.10 | 2.5% | | (I) |
| | C1608X7R102KGT | C1608X7R102KGT | 1V, 1kHz | 1.0 | nF | ±10% | 0.80 | ±0.10 | ±0.10 | 2.5% | | (I) |
| | C1608X7R122KGT | C1608X7R122KGT | 1V, 1kHz | 1.2 | nF | ±10% | 0.80 | ±0.10 | ±0.10 | 2.5% | | (I) |
| | C1608X7R152KGT | C1608X7R152KGT | 1V, 1kHz | 1.5 | nF | ±10% | 0.80 | ±0.10 | ±0.10 | 2.5% | | (I) |
| | C1608X7R182KGT | C1608X7R182KGT | 1V, 1kHz | 1.8 | nF | ±10% | 0.80 | ±0.10 | ±0.10 | 2.5% | | (I) |
| | C1608X7R202KGT | C1608X7R202KGT | 1V, 1kHz | 2.0 | nF | ±10% | 0.80 | ±0.10 | ±0.10 | 2.5% | | (I) |
| | C1608X7R222KGT | C1608X7R222KGT | 1V, 1kHz | 2.2 | nF | ±10% | 0.80 | ±0.10 | ±0.10 | 2.5% | | (I) |
| | C1608X7R272KGT | C1608X7R272KGT | 1V, 1kHz | 2.7 | nF | ±10% | 0.80 | ±0.10 | ±0.10 | 2.5% | | (I) |
| | C1608X7R332KGT | C1608X7R332KGT | 1V, 1kHz | 3.3 | nF | ±10% | 0.80 | ±0.10 | ±0.10 | 2.5% | | (I) |
| | C1608X7R392KGT | C1608X7R392KGT | 1V, 1kHz | 3.9 | nF | ±10% | 0.80 | ±0.10 | ±0.10 | 2.5% | | (I) |
| | C1608X7R472KGT | C1608X7R472KGT | 1V, 1kHz | 4.7 | nF | ±10% | 0.80 | ±0.10 | ±0.10 | 2.5% | | (I) |
| | C1608X7R562KGT | C1608X7R562KGT | 1V, 1kHz | 5.6 | nF | ±10% | 0.80 | ±0.10 | ±0.10 | 2.5% | | (I) |
| | C1608X7R682KGT | C1608X7R682KGT | 1V, 1kHz | 6.8 | nF | ±10% | 0.80 | ±0.10 | ±0.10 | 2.5% | | (I) |
| | C1608X7R822KGT | C1608X7R822KGT | 1V, 1kHz | 8.2 | nF | ±10% | 0.80 | ±0.10 | ±0.10 | 2.5% | | (I) |
| | C1608X7R103□GTS | C1608X7R103□GT | 1V, 1kHz | 10 | nF | ±10%,±5% | 0.80 | ±0.10 | ±0.10 | 2.5% | | (I) |
| | C1608X7R123KGT | C1608X7R123KGT | 1V, 1kHz | 12 | nF | ±10% | 0.80 | ±0.10 | ±0.10 | 2.5% | | (I) |
| | C1608X7R153KGT | C1608X7R153KGT | 1V, 1kHz | 15 | nF | ±10% | 0.80 | ±0.10 | ±0.10 | 2.5% | | (I) |
| | C1608X7R183□GTS | C1608X7R183□GT | 1V, 1kHz | 18 | nF | ±10%,±5% | 0.80 | ±0.10 | ±0.10 | 2.5% | | (I) |
| | C1608X7R223KGT | C1608X7R223KGT | 1V, 1kHz | 22 | nF | ±10% | 0.80 | ±0.10 | ±0.10 | 2.5% | | (I) |
| | C1608X7R273KGT | C1608X7R273KGT | 1V, 1kHz | 27 | nF | ±10% | 0.80 | ±0.10 | ±0.10 | 2.5% | | (I) |
| | C1608X7R333KGT | C1608X7R333KGT | 1V, 1kHz | 33 | nF | ±10% | 0.80 | ±0.15 | ±0.15 | 2.5% | | (I) |
| | C1608X7R393KGT | C1608X7R393KGT | 1V, 1kHz | 39 | nF | ±10% | 0.80 | ±0.15 | ±0.15 | 2.5% | | (I) |
| | C1608X7R473KGT | C1608X7R473KGT | 1V, 1kHz | 47 | nF | ±10% | 0.80 | ±0.15 | ±0.15 | 3.0% | | (I) |
| | C1608X7R563KGT | C1608X7R563KGT | 1V, 1kHz | 56 | nF | ±10% | 0.80 | ±0.15 | ±0.15 | 3.0% | | (I) |
| | C1608X7R683KGT | C1608X7R683KGT | 1V, 1kHz | 68 | nF | ±10% | 0.80 | ±0.15 | ±0.15 | 3.0% | | (I) |
| C1608X7R823KGT | C1608X7R823KGT | 1V, 1kHz | 82 | nF | ±10% | 0.80 | ±0.15 | ±0.15 | 3.0% | (I) | | |
| C1608X7R104KGT | C1608X7R104KGT | 1V, 1kHz | 100 | nF | ±10% | 0.80 | ±0.15 | ±0.15 | 3.0% | (II) | | |
| C1608X7R224KGT | C1608X7R224KGT | 1V, 1kHz | 220 | nF | ±10% | 0.80 | ±0.15 | ±0.15 | 3.5% | (II) | | |
| C1608X7R474KGT | C1608X7R474KGT | 1V, 1kHz | 470 | nF | ±10% | 0.80 | ±0.15 | ±0.15 | 10.0% | (II) | | |
| C1608X7R105KGT | C1608X7R105KGT | 1V, 1kHz | 1.0 | uF | ±10% | 0.80 | ±0.20 | ±0.20 | 10.0% | (II) | | |
| 35V | C1608X7R474KNTS | C1608X7R474KNT | 1V, 1kHz | 470 | nF | ±10% | 0.80 | ±0.15 | ±0.15 | 10.0% | Paper, 4Kpcs | (II) |
| | C1608X7R105KNTS | C1608X7R105KNT | 1V, 1kHz | 1.0 | uF | ±10% | 0.80 | ±0.20 | ±0.20 | 10.0% | | (II) |
| 25V | C1608X7R101KFTS | C1608X7R101KFT | 1V, 1kHz | 100 | pF | ±10% | 0.80 | ±0.10 | ±0.10 | 3.5% | Paper, 4Kpcs | (I) |
| | C1608X7R121KFTS | C1608X7R121KFT | 1V, 1kHz | 120 | pF | ±10% | 0.80 | ±0.10 | ±0.10 | 3.5% | | (I) |
| | C1608X7R151KFTS | C1608X7R151KFT | 1V, 1kHz | 150 | pF | ±10% | 0.80 | ±0.10 | ±0.10 | 3.5% | | (I) |
| | C1608X7R181KFTS | C1608X7R181KFT | 1V, 1kHz | 180 | pF | ±10% | 0.80 | ±0.10 | ±0.10 | 3.5% | | (I) |
| | C1608X7R221KFTS | C1608X7R221KFT | 1V, 1kHz | 220 | pF | ±10% | 0.80 | ±0.10 | ±0.10 | 3.5% | | (I) |
| | C1608X7R271KFTS | C1608X7R271KFT | 1V, 1kHz | 270 | pF | ±10% | 0.80 | ±0.10 | ±0.10 | 3.5% | | (I) |
| | C1608X7R331KFTS | C1608X7R331KFT | 1V, 1kHz | 330 | pF | ±10% | 0.80 | ±0.10 | ±0.10 | 3.5% | | (I) |
| | C1608X7R391KFTS | C1608X7R391KFT | 1V, 1kHz | 390 | pF | ±10% | 0.80 | ±0.10 | ±0.10 | 3.5% | | (I) |
| | C1608X7R471KFTS | C1608X7R471KFT | 1V, 1kHz | 470 | pF | ±10% | 0.80 | ±0.10 | ±0.10 | 3.5% | | (I) |
| | C1608X7R561KFTS | C1608X7R561KFT | 1V, 1kHz | 560 | pF | ±10% | 0.80 | ±0.10 | ±0.10 | 3.5% | | (I) |
| | C1608X7R681KFTS | C1608X7R681KFT | 1V, 1kHz | 680 | pF | ±10% | 0.80 | ±0.10 | ±0.10 | 3.5% | | (I) |
| | C1608X7R821KFTS | C1608X7R821KFT | 1V, 1kHz | 820 | pF | ±10% | 0.80 | ±0.10 | ±0.10 | 3.5% | | (I) |
| | C1608X7R102KFTS | C1608X7R102KFT | 1V, 1kHz | 1.0 | nF | ±10% | 0.80 | ±0.10 | ±0.10 | 3.5% | | (I) |
| | C1608X7R122KFTS | C1608X7R122KFT | 1V, 1kHz | 1.2 | nF | ±10% | 0.80 | ±0.10 | ±0.10 | 3.5% | | (I) |
| | C1608X7R152KFTS | C1608X7R152KFT | 1V, 1kHz | 1.5 | nF | ±10% | 0.80 | ±0.10 | ±0.10 | 3.5% | | (I) |
| | C1608X7R182KFTS | C1608X7R182KFT | 1V, 1kHz | 1.8 | nF | ±10% | 0.80 | ±0.10 | ±0.10 | 3.5% | | (I) |
| | C1608X7R222KFTS | C1608X7R222KFT | 1V, 1kHz | 2.2 | nF | ±10% | 0.80 | ±0.10 | ±0.10 | 3.5% | | (I) |
| | C1608X7R272KFTS | C1608X7R272KFT | 1V, 1kHz | 2.7 | nF | ±10% | 0.80 | ±0.10 | ±0.10 | 3.5% | | (I) |
| | C1608X7R332KFTS | C1608X7R332KFT | 1V, 1kHz | 3.3 | nF | ±10% | 0.80 | ±0.10 | ±0.10 | 3.5% | | (I) |
| | C1608X7R392KFTS | C1608X7R392KFT | 1V, 1kHz | 3.9 | nF | ±10% | 0.80 | ±0.10 | ±0.10 | 3.5% | | (I) |
| | C1608X7R472KFTS | C1608X7R472KFT | 1V, 1kHz | 4.7 | nF | ±10% | 0.80 | ±0.10 | ±0.10 | 3.5% | | (I) |
| | C1608X7R562KFTS | C1608X7R562KFT | 1V, 1kHz | 5.6 | nF | ±10% | 0.80 | ±0.10 | ±0.10 | 3.5% | | (I) |
| C1608X7R682KFTS | C1608X7R682KFT | 1V, 1kHz | 6.8 | nF | ±10% | 0.80 | ±0.10 | ±0.10 | 3.5% | (I) | | |
| C1608X7R822KFTS | C1608X7R822KFT | 1V, 1kHz | 8.2 | nF | ±10% | 0.80 | ±0.10 | ±0.10 | 3.5% | (I) | | |
| C1608X7R103KFTS | C1608X7R103KFT | 1V, 1kHz | 10 | nF | ±10% | 0.80 | ±0.10 | ±0.10 | 3.5% | (I) | | |

□ Tolerance Code: J=±5%, K=±10%, M=±20%; Special tolerance on the request.

| RV | DARFON P/N | DARFON P/N 2 | Measuring Condition | Capacitance | | Available Tolerance | Thick. (mm) | Tolerance(mm) | | DF (max.) | Standard Packing | Test Spec. |
|------------------|------------------|----------------|---------------------|-------------|------------|---------------------|-------------|---------------|--------|-----------|------------------|------------|
| | | | | Value | Unit | | | L/W | Thick. | | | |
| 25V | C1608X7R123KFSTS | C1608X7R123KFT | 1V, 1kHz | 12 | nF | ±10% | 0.80 | ±0.10 | ±0.10 | 3.5% | Paper, 4Kpcs | (I) |
| | C1608X7R153KFSTS | C1608X7R153KFT | 1V, 1kHz | 15 | nF | ±10% | 0.80 | ±0.10 | ±0.10 | 3.5% | | (I) |
| | C1608X7R183KFSTS | C1608X7R183KFT | 1V, 1kHz | 18 | nF | ±10% | 0.80 | ±0.10 | ±0.10 | 3.5% | | (I) |
| | C1608X7R223□FSTS | C1608X7R223□FT | 1V, 1kHz | 22 | nF | ±10%,±5% | 0.80 | ±0.10 | ±0.10 | 3.5% | | (I) |
| | C1608X7R273□FSTS | C1608X7R273□FT | 1V, 1kHz | 27 | nF | ±10%,±5% | 0.80 | ±0.10 | ±0.10 | 3.5% | | (I) |
| | C1608X7R333KFSTS | C1608X7R333KFT | 1V, 1kHz | 33 | nF | ±10% | 0.80 | ±0.10 | ±0.10 | 3.5% | | (I) |
| | C1608X7R393KFSTS | C1608X7R393KFT | 1V, 1kHz | 39 | nF | ±10% | 0.80 | ±0.10 | ±0.10 | 3.5% | | (I) |
| | C1608X7R473KFSTS | C1608X7R473KFT | 1V, 1kHz | 47 | nF | ±10% | 0.80 | ±0.10 | ±0.10 | 3.5% | | (I) |
| | C1608X7R563KFSTS | C1608X7R563KFT | 1V, 1kHz | 56 | nF | ±10% | 0.80 | ±0.10 | ±0.10 | 3.5% | | (I) |
| | C1608X7R683KFSTS | C1608X7R683KFT | 1V, 1kHz | 68 | nF | ±10% | 0.80 | ±0.10 | ±0.10 | 3.5% | | (I) |
| | C1608X7R823KFSTS | C1608X7R823KFT | 1V, 1kHz | 82 | nF | ±10% | 0.80 | ±0.10 | ±0.10 | 3.5% | | (I) |
| | C1608X7R104KFSTS | C1608X7R104KFT | 1V, 1kHz | 100 | nF | ±10% | 0.80 | ±0.10 | ±0.10 | 3.5% | | (I) |
| | C1608X7R124KFSTS | C1608X7R124KFT | 1V, 1kHz | 120 | nF | ±10% | 0.80 | ±0.15 | ±0.15 | 3.5% | | (I) |
| | C1608X7R154KFSTS | C1608X7R154KFT | 1V, 1kHz | 150 | nF | ±10% | 0.80 | ±0.15 | ±0.15 | 3.5% | | (I) |
| | C1608X7R184KFSTS | C1608X7R184KFT | 1V, 1kHz | 180 | nF | ±10% | 0.80 | ±0.15 | ±0.15 | 3.5% | | (I) |
| | C1608X7R224KFSTS | C1608X7R224KFT | 1V, 1kHz | 220 | nF | ±10% | 0.80 | ±0.15 | ±0.15 | 3.5% | | (I) |
| | C1608X7R334KFSTS | C1608X7R334KFT | 1V, 1kHz | 330 | nF | ±10% | 0.80 | ±0.15 | ±0.15 | 7.0% | | (I) |
| C1608X7R474KFSTS | C1608X7R474KFT | 1V, 1kHz | 470 | nF | ±10% | 0.80 | ±0.15 | ±0.15 | 10.0% | (I) | | |
| C1608X7R105KFSTS | C1608X7R105KFT | 1V, 1kHz | 1.0 | uF | ±10% | 0.80 | ±0.15 | ±0.15 | 10.0% | (II) | | |
| 16V | C1608X7R101KETS | C1608X7R101KET | 1V, 1kHz | 100 | pF | ±10% | 0.80 | ±0.10 | ±0.10 | 5.0% | Paper, 4Kpcs | (I) |
| | C1608X7R121KETS | C1608X7R121KET | 1V, 1kHz | 120 | pF | ±10% | 0.80 | ±0.10 | ±0.10 | 5.0% | | (I) |
| | C1608X7R151KETS | C1608X7R151KET | 1V, 1kHz | 150 | pF | ±10% | 0.80 | ±0.10 | ±0.10 | 5.0% | | (I) |
| | C1608X7R181KETS | C1608X7R181KET | 1V, 1kHz | 180 | pF | ±10% | 0.80 | ±0.10 | ±0.10 | 5.0% | | (I) |
| | C1608X7R221KETS | C1608X7R221KET | 1V, 1kHz | 220 | pF | ±10% | 0.80 | ±0.10 | ±0.10 | 5.0% | | (I) |
| | C1608X7R271KETS | C1608X7R271KET | 1V, 1kHz | 270 | pF | ±10% | 0.80 | ±0.10 | ±0.10 | 5.0% | | (I) |
| | C1608X7R331KETS | C1608X7R331KET | 1V, 1kHz | 330 | pF | ±10% | 0.80 | ±0.10 | ±0.10 | 5.0% | | (I) |
| | C1608X7R391KETS | C1608X7R391KET | 1V, 1kHz | 390 | pF | ±10% | 0.80 | ±0.10 | ±0.10 | 5.0% | | (I) |
| | C1608X7R471KETS | C1608X7R471KET | 1V, 1kHz | 470 | pF | ±10% | 0.80 | ±0.10 | ±0.10 | 5.0% | | (I) |
| | C1608X7R561KETS | C1608X7R561KET | 1V, 1kHz | 560 | pF | ±10% | 0.80 | ±0.10 | ±0.10 | 5.0% | | (I) |
| | C1608X7R681KETS | C1608X7R681KET | 1V, 1kHz | 680 | pF | ±10% | 0.80 | ±0.10 | ±0.10 | 5.0% | | (I) |
| | C1608X7R821KETS | C1608X7R821KET | 1V, 1kHz | 820 | pF | ±10% | 0.80 | ±0.10 | ±0.10 | 5.0% | | (I) |
| | C1608X7R102KETS | C1608X7R102KET | 1V, 1kHz | 1.0 | nF | ±10% | 0.80 | ±0.10 | ±0.10 | 5.0% | | (I) |
| | C1608X7R122KETS | C1608X7R122KET | 1V, 1kHz | 1.2 | nF | ±10% | 0.80 | ±0.10 | ±0.10 | 5.0% | | (I) |
| | C1608X7R152KETS | C1608X7R152KET | 1V, 1kHz | 1.5 | nF | ±10% | 0.80 | ±0.10 | ±0.10 | 5.0% | | (I) |
| | C1608X7R182KETS | C1608X7R182KET | 1V, 1kHz | 1.8 | nF | ±10% | 0.80 | ±0.10 | ±0.10 | 5.0% | | (I) |
| | C1608X7R222KETS | C1608X7R222KET | 1V, 1kHz | 2.2 | nF | ±10% | 0.80 | ±0.10 | ±0.10 | 5.0% | | (I) |
| | C1608X7R272KETS | C1608X7R272KET | 1V, 1kHz | 2.7 | nF | ±10% | 0.80 | ±0.10 | ±0.10 | 5.0% | | (I) |
| | C1608X7R332KETS | C1608X7R332KET | 1V, 1kHz | 3.3 | nF | ±10% | 0.80 | ±0.10 | ±0.10 | 5.0% | | (I) |
| | C1608X7R392KETS | C1608X7R392KET | 1V, 1kHz | 3.9 | nF | ±10% | 0.80 | ±0.10 | ±0.10 | 5.0% | | (I) |
| | C1608X7R472KETS | C1608X7R472KET | 1V, 1kHz | 4.7 | nF | ±10% | 0.80 | ±0.10 | ±0.10 | 5.0% | | (I) |
| | C1608X7R562KETS | C1608X7R562KET | 1V, 1kHz | 5.6 | nF | ±10% | 0.80 | ±0.10 | ±0.10 | 5.0% | | (I) |
| | C1608X7R682KETS | C1608X7R682KET | 1V, 1kHz | 6.8 | nF | ±10% | 0.80 | ±0.10 | ±0.10 | 5.0% | | (I) |
| | C1608X7R822KETS | C1608X7R822KET | 1V, 1kHz | 8.2 | nF | ±10% | 0.80 | ±0.10 | ±0.10 | 5.0% | | (I) |
| | C1608X7R103KETS | C1608X7R103KET | 1V, 1kHz | 10 | nF | ±10% | 0.80 | ±0.10 | ±0.10 | 5.0% | | (I) |
| | C1608X7R123KETS | C1608X7R123KET | 1V, 1kHz | 12 | nF | ±10% | 0.80 | ±0.10 | ±0.10 | 5.0% | | (I) |
| | C1608X7R153KETS | C1608X7R153KET | 1V, 1kHz | 15 | nF | ±10% | 0.80 | ±0.10 | ±0.10 | 5.0% | | (I) |
| | C1608X7R183KETS | C1608X7R183KET | 1V, 1kHz | 18 | nF | ±10% | 0.80 | ±0.10 | ±0.10 | 5.0% | | (I) |
| | C1608X7R223KETS | C1608X7R223KET | 1V, 1kHz | 22 | nF | ±10% | 0.80 | ±0.10 | ±0.10 | 5.0% | | (I) |
| | C1608X7R273KETS | C1608X7R273KET | 1V, 1kHz | 27 | nF | ±10% | 0.80 | ±0.10 | ±0.10 | 5.0% | | (I) |
| | C1608X7R333KETS | C1608X7R333KET | 1V, 1kHz | 33 | nF | ±10% | 0.80 | ±0.10 | ±0.10 | 5.0% | | (I) |
| | C1608X7R393KETS | C1608X7R393KET | 1V, 1kHz | 39 | nF | ±10% | 0.80 | ±0.10 | ±0.10 | 5.0% | | (I) |
| | C1608X7R473KETS | C1608X7R473KET | 1V, 1kHz | 47 | nF | ±10% | 0.80 | ±0.10 | ±0.10 | 5.0% | | (I) |
| | C1608X7R563KETS | C1608X7R563KET | 1V, 1kHz | 56 | nF | ±10% | 0.80 | ±0.10 | ±0.10 | 5.0% | | (I) |
| C1608X7R683KETS | C1608X7R683KET | 1V, 1kHz | 68 | nF | ±10% | 0.80 | ±0.10 | ±0.10 | 5.0% | (I) | | |
| C1608X7R823KETS | C1608X7R823KET | 1V, 1kHz | 82 | nF | ±10% | 0.80 | ±0.10 | ±0.10 | 5.0% | (I) | | |
| C1608X7R104KETS | C1608X7R104KET | 1V, 1kHz | 100 | nF | ±10% | 0.80 | ±0.10 | ±0.10 | 5.0% | (I) | | |
| C1608X7R154KETS | C1608X7R154KET | 1V, 1kHz | 150 | nF | ±10% | 0.80 | ±0.10 | ±0.10 | 5.0% | (I) | | |
| C1608X7R184KETS | C1608X7R184KET | 1V, 1kHz | 180 | nF | ±10% | 0.80 | ±0.15 | ±0.15 | 5.0% | (I) | | |
| C1608X7R224KETS | C1608X7R224KET | 1V, 1kHz | 220 | nF | ±10% | 0.80 | ±0.15 | ±0.15 | 5.0% | (I) | | |
| C1608X7R334KETS | C1608X7R334KET | 1V, 1kHz | 330 | nF | ±10% | 0.80 | ±0.15 | ±0.15 | 5.0% | (I) | | |
| C1608X7R474KETS | C1608X7R474KET | 1V, 1kHz | 470 | nF | ±10% | 0.80 | ±0.15 | ±0.15 | 5.0% | (I) | | |
| C1608X7R684KETS | C1608X7R684KET | 1V, 1kHz | 680 | nF | ±10% | 0.80 | ±0.15 | ±0.15 | 10.0% | (I) | | |
| C1608X7R105□ETS | C1608X7R105□ET | 1V, 1kHz | 1.0 | uF | ±10%, ±20% | 0.80 | ±0.15 | ±0.15 | 10.0% | (II) | | |
| C1608X7R225KETS | C1608X7R225KET | 1V, 1kHz | 2.2 | uF | ±10% | 0.80 | ±0.20 | ±0.20 | 10.0% | (II) | | |

| RV | DARFON P/N | DARFON P/N 2 | Measuring Condition | Capacitance | | Available Tolerance | Thick. (mm) | Tolerance(mm) | | DF (max.) | Standard Packing | Test Spec. |
|-----------------|-----------------|----------------|---------------------|-------------|------|---------------------|-------------|---------------|--------|-----------|------------------|------------|
| | | | | Value | Unit | | | L/W | Thick. | | | |
| 10V | C1608X7R101KDTS | C1608X7R101KDT | 1V, 1kHz | 100 | pF | ±10% | 0.80 | ±0.10 | ±0.10 | 5.0% | Paper, 4Kpcs | (I) |
| | C1608X7R121KDTS | C1608X7R121KDT | 1V, 1kHz | 120 | pF | ±10% | 0.80 | ±0.10 | ±0.10 | 5.0% | | (I) |
| | C1608X7R151KDTS | C1608X7R151KDT | 1V, 1kHz | 150 | pF | ±10% | 0.80 | ±0.10 | ±0.10 | 5.0% | | (I) |
| | C1608X7R181KDTS | C1608X7R181KDT | 1V, 1kHz | 180 | pF | ±10% | 0.80 | ±0.10 | ±0.10 | 5.0% | | (I) |
| | C1608X7R221KDTS | C1608X7R221KDT | 1V, 1kHz | 220 | pF | ±10% | 0.80 | ±0.10 | ±0.10 | 5.0% | | (I) |
| | C1608X7R271KDTS | C1608X7R271KDT | 1V, 1kHz | 270 | pF | ±10% | 0.80 | ±0.10 | ±0.10 | 5.0% | | (I) |
| | C1608X7R331KDTS | C1608X7R331KDT | 1V, 1kHz | 330 | pF | ±10% | 0.80 | ±0.10 | ±0.10 | 5.0% | | (I) |
| | C1608X7R391KDTS | C1608X7R391KDT | 1V, 1kHz | 390 | pF | ±10% | 0.80 | ±0.10 | ±0.10 | 5.0% | | (I) |
| | C1608X7R471KDTS | C1608X7R471KDT | 1V, 1kHz | 470 | pF | ±10% | 0.80 | ±0.10 | ±0.10 | 5.0% | | (I) |
| | C1608X7R561KDTS | C1608X7R561KDT | 1V, 1kHz | 560 | pF | ±10% | 0.80 | ±0.10 | ±0.10 | 5.0% | | (I) |
| | C1608X7R681KDTS | C1608X7R681KDT | 1V, 1kHz | 680 | pF | ±10% | 0.80 | ±0.10 | ±0.10 | 5.0% | | (I) |
| | C1608X7R821KDTS | C1608X7R821KDT | 1V, 1kHz | 820 | pF | ±10% | 0.80 | ±0.10 | ±0.10 | 5.0% | | (I) |
| | C1608X7R102KDTS | C1608X7R102KDT | 1V, 1kHz | 1.0 | nF | ±10% | 0.80 | ±0.10 | ±0.10 | 5.0% | | (I) |
| | C1608X7R122KDTS | C1608X7R122KDT | 1V, 1kHz | 1.2 | nF | ±10% | 0.80 | ±0.10 | ±0.10 | 5.0% | | (I) |
| | C1608X7R152KDTS | C1608X7R152KDT | 1V, 1kHz | 1.5 | nF | ±10% | 0.80 | ±0.10 | ±0.10 | 5.0% | | (I) |
| | C1608X7R182KDTS | C1608X7R182KDT | 1V, 1kHz | 1.8 | nF | ±10% | 0.80 | ±0.10 | ±0.10 | 5.0% | | (I) |
| | C1608X7R222KDTS | C1608X7R222KDT | 1V, 1kHz | 2.2 | nF | ±10% | 0.80 | ±0.10 | ±0.10 | 5.0% | | (I) |
| | C1608X7R272KDTS | C1608X7R272KDT | 1V, 1kHz | 2.7 | nF | ±10% | 0.80 | ±0.10 | ±0.10 | 5.0% | | (I) |
| | C1608X7R332KDTS | C1608X7R332KDT | 1V, 1kHz | 3.3 | nF | ±10% | 0.80 | ±0.10 | ±0.10 | 5.0% | | (I) |
| | C1608X7R392KDTS | C1608X7R392KDT | 1V, 1kHz | 3.9 | nF | ±10% | 0.80 | ±0.10 | ±0.10 | 5.0% | | (I) |
| | C1608X7R472KDTS | C1608X7R472KDT | 1V, 1kHz | 4.7 | nF | ±10% | 0.80 | ±0.10 | ±0.10 | 5.0% | | (I) |
| | C1608X7R562KDTS | C1608X7R562KDT | 1V, 1kHz | 5.6 | nF | ±10% | 0.80 | ±0.10 | ±0.10 | 5.0% | | (I) |
| | C1608X7R682KDTS | C1608X7R682KDT | 1V, 1kHz | 6.8 | nF | ±10% | 0.80 | ±0.10 | ±0.10 | 5.0% | | (I) |
| | C1608X7R822KDTS | C1608X7R822KDT | 1V, 1kHz | 8.2 | nF | ±10% | 0.80 | ±0.10 | ±0.10 | 5.0% | | (I) |
| | C1608X7R103KDTS | C1608X7R103KDT | 1V, 1kHz | 10 | nF | ±10% | 0.80 | ±0.10 | ±0.10 | 5.0% | | (I) |
| | C1608X7R123KDTS | C1608X7R123KDT | 1V, 1kHz | 12 | nF | ±10% | 0.80 | ±0.10 | ±0.10 | 5.0% | | (I) |
| | C1608X7R153KDTS | C1608X7R153KDT | 1V, 1kHz | 15 | nF | ±10% | 0.80 | ±0.10 | ±0.10 | 5.0% | | (I) |
| | C1608X7R183KDTS | C1608X7R183KDT | 1V, 1kHz | 18 | nF | ±10% | 0.80 | ±0.10 | ±0.10 | 5.0% | | (I) |
| | C1608X7R223KDTS | C1608X7R223KDT | 1V, 1kHz | 22 | nF | ±10% | 0.80 | ±0.10 | ±0.10 | 5.0% | | (I) |
| | C1608X7R273KDTS | C1608X7R273KDT | 1V, 1kHz | 27 | nF | ±10% | 0.80 | ±0.10 | ±0.10 | 5.0% | | (I) |
| | C1608X7R333KDTS | C1608X7R333KDT | 1V, 1kHz | 33 | nF | ±10% | 0.80 | ±0.10 | ±0.10 | 5.0% | | (I) |
| | C1608X7R393KDTS | C1608X7R393KDT | 1V, 1kHz | 39 | nF | ±10% | 0.80 | ±0.10 | ±0.10 | 5.0% | | (I) |
| | C1608X7R473KDTS | C1608X7R473KDT | 1V, 1kHz | 47 | nF | ±10% | 0.80 | ±0.10 | ±0.10 | 5.0% | | (I) |
| C1608X7R563KDTS | C1608X7R563KDT | 1V, 1kHz | 56 | nF | ±10% | 0.80 | ±0.10 | ±0.10 | 5.0% | (I) | | |
| C1608X7R683KDTS | C1608X7R683KDT | 1V, 1kHz | 68 | nF | ±10% | 0.80 | ±0.10 | ±0.10 | 5.0% | (I) | | |
| C1608X7R823KDTS | C1608X7R823KDT | 1V, 1kHz | 82 | nF | ±10% | 0.80 | ±0.10 | ±0.10 | 5.0% | (I) | | |
| C1608X7R104KDTS | C1608X7R104KDT | 1V, 1kHz | 100 | nF | ±10% | 0.80 | ±0.10 | ±0.10 | 5.0% | (I) | | |
| C1608X7R224KDTS | C1608X7R224KDT | 1V, 1kHz | 220 | nF | ±10% | 0.80 | ±0.15 | ±0.15 | 5.0% | (I) | | |
| C1608X7R334KDTS | C1608X7R334KDT | 1V, 1kHz | 330 | nF | ±10% | 0.80 | ±0.15 | ±0.15 | 10.0% | (I) | | |
| C1608X7R474KDTS | C1608X7R474KDT | 1V, 1kHz | 470 | nF | ±10% | 0.80 | ±0.15 | ±0.15 | 10.0% | (I) | | |
| C1608X7R684KDTS | C1608X7R684KDT | 1V, 1kHz | 680 | nF | ±10% | 0.80 | ±0.15 | ±0.15 | 10.0% | (I) | | |
| C1608X7R105KDTS | C1608X7R105KDT | 1V, 1kHz | 1.0 | uF | ±10% | 0.80 | ±0.15 | ±0.15 | 10.0% | (II) | | |
| C1608X7R225KDTS | C1608X7R225KDT | 1V, 1kHz | 2.2 | uF | ±10% | 0.80 | ±0.15 | ±0.10 | 10.0% | (II) | | |
| 6.3V | C1608X7R104KCTS | C1608X7R104KCT | 1V, 1kHz | 100 | nF | ±10% | 0.80 | ±0.10 | ±0.10 | 5.0% | Paper, 4Kpcs | (I) |
| | C1608X7R105KCTS | C1608X7R105KCT | 1V, 1kHz | 1.0 | uF | ±10% | 0.80 | ±0.15 | ±0.15 | 10.0% | | (II) |
| | C1608X7R225KCTS | C1608X7R225KCT | 1V, 1kHz | 2.2 | uF | ±10% | 0.80 | ±0.15 | ±0.10 | 10.0% | | (II) |
| | C1608X7R475KCTS | C1608X7R475KCT | 1V, 1kHz | 4.7 | uF | ±10% | 0.80 | ±0.20 | ±0.20 | 10.0% | | (II) |
| | C1608X7R106MCTS | C1608X7R106MCT | 0.5V, 1kHz | 10 | uF | ±20% | 0.80 | ±0.20 | ±0.20 | 10.0% | | (III)* |

□ Tolerance Code: J=±5%, K=±10%, M=±20%; Special tolerance on the request.

● C2012X7R Series (EIA0805)

| RV | DARFON P/N | DARFON P/N 2 | Measuring Condition | Capacitance | | Available Tolerance | Thick. (mm) | Tolerance(mm) | | DF (max.) | Standard Packing | Test Spec. |
|-----|-----------------|----------------|---------------------|-------------|------|---------------------|-------------|---------------|--------|-----------|------------------|------------|
| | | | | Value | Unit | | | L/W | Thick. | | | |
| 50V | C2012X7R101KGTS | C2012X7R101KGT | 1V, 1kHz | 100 | pF | ±10% | 0.85 | ±0.15 | ±0.15 | 2.5% | Paper, 4Kpcs | (I) |
| | C2012X7R151KGTS | C2012X7R151KGT | 1V, 1kHz | 150 | pF | ±10% | 0.60 | ±0.15 | ±0.15 | 2.5% | | (I) |
| | C2012X7R181KGTS | C2012X7R181KGT | 1V, 1kHz | 180 | pF | ±10% | 0.60 | ±0.15 | ±0.15 | 2.5% | | (I) |
| | C2012X7R221KGTS | C2012X7R221KGT | 1V, 1kHz | 220 | pF | ±10% | 0.60 | ±0.15 | ±0.15 | 2.5% | | (I) |
| | C2012X7R271KGTS | C2012X7R271KGT | 1V, 1kHz | 270 | pF | ±10% | 0.60 | ±0.15 | ±0.15 | 2.5% | | (I) |
| | C2012X7R331KGTS | C2012X7R331KGT | 1V, 1kHz | 330 | pF | ±10% | 0.60 | ±0.15 | ±0.15 | 2.5% | | (I) |
| | C2012X7R391KGTS | C2012X7R391KGT | 1V, 1kHz | 390 | pF | ±10% | 0.60 | ±0.15 | ±0.15 | 2.5% | | (I) |
| | C2012X7R471KGTS | C2012X7R471KGT | 1V, 1kHz | 470 | pF | ±10% | 0.60 | ±0.15 | ±0.15 | 2.5% | | (I) |
| | C2012X7R561KGTS | C2012X7R561KGT | 1V, 1kHz | 560 | pF | ±10% | 0.60 | ±0.15 | ±0.15 | 2.5% | | (I) |
| | C2012X7R681KGTS | C2012X7R681KGT | 1V, 1kHz | 680 | pF | ±10% | 0.60 | ±0.15 | ±0.15 | 2.5% | | (I) |
| | C2012X7R821KGTS | C2012X7R821KGT | 1V, 1kHz | 820 | pF | ±10% | 0.60 | ±0.15 | ±0.15 | 2.5% | | (I) |
| | C2012X7R102KGTS | C2012X7R102KGT | 1V, 1kHz | 1.0 | nF | ±10% | 0.60 | ±0.15 | ±0.15 | 2.5% | | (I) |
| | C2012X7R122KGTS | C2012X7R122KGT | 1V, 1kHz | 1.2 | nF | ±10% | 0.60 | ±0.15 | ±0.15 | 2.5% | | (I) |
| | C2012X7R152KGTS | C2012X7R152KGT | 1V, 1kHz | 1.5 | nF | ±10% | 0.60 | ±0.15 | ±0.15 | 2.5% | | (I) |
| | C2012X7R182KGTS | C2012X7R182KGT | 1V, 1kHz | 1.8 | nF | ±10% | 0.60 | ±0.15 | ±0.15 | 2.5% | | (I) |
| | C2012X7R222KGTS | C2012X7R222KGT | 1V, 1kHz | 2.2 | nF | ±10% | 0.60 | ±0.15 | ±0.15 | 2.5% | | (I) |
| | C2012X7R272KGTS | C2012X7R272KGT | 1V, 1kHz | 2.7 | nF | ±10% | 0.60 | ±0.15 | ±0.15 | 2.5% | | (I) |
| | C2012X7R332KGTS | C2012X7R332KGT | 1V, 1kHz | 3.3 | nF | ±10% | 0.60 | ±0.15 | ±0.15 | 2.5% | | (I) |
| | C2012X7R392KGTS | C2012X7R392KGT | 1V, 1kHz | 3.9 | nF | ±10% | 0.60 | ±0.15 | ±0.15 | 2.5% | | (I) |
| | C2012X7R472KGTS | C2012X7R472KGT | 1V, 1kHz | 4.7 | nF | ±10% | 0.60 | ±0.15 | ±0.15 | 2.5% | | (I) |
| | C2012X7R562KGTS | C2012X7R562KGT | 1V, 1kHz | 5.6 | nF | ±10% | 0.60 | ±0.15 | ±0.15 | 2.5% | | (I) |
| | C2012X7R682KGTS | C2012X7R682KGT | 1V, 1kHz | 6.8 | nF | ±10% | 0.60 | ±0.15 | ±0.15 | 2.5% | | (I) |
| | C2012X7R822KGTS | C2012X7R822KGT | 1V, 1kHz | 8.2 | nF | ±10% | 0.60 | ±0.15 | ±0.15 | 2.5% | | (I) |
| | C2012X7R103KGTS | C2012X7R103KGT | 1V, 1kHz | 10 | nF | ±10% | 0.60 | ±0.15 | ±0.15 | 2.5% | | (I) |
| | C2012X7R123KGTS | C2012X7R123KGT | 1V, 1kHz | 12 | nF | ±10% | 0.60 | ±0.15 | ±0.15 | 2.5% | | (I) |
| | C2012X7R153KGTS | C2012X7R153KGT | 1V, 1kHz | 15 | nF | ±10% | 0.60 | ±0.15 | ±0.15 | 2.5% | | (I) |
| | C2012X7R183KGTS | C2012X7R183KGT | 1V, 1kHz | 18 | nF | ±10% | 0.60 | ±0.15 | ±0.15 | 2.5% | | (I) |
| | C2012X7R223KGTS | C2012X7R223KGT | 1V, 1kHz | 22 | nF | ±10% | 0.60 | ±0.15 | ±0.15 | 2.5% | | (I) |
| | C2012X7R273KGTS | C2012X7R273KGT | 1V, 1kHz | 27 | nF | ±10% | 0.60 | ±0.15 | ±0.15 | 2.5% | | (I) |
| | C2012X7R333KGTS | C2012X7R333KGT | 1V, 1kHz | 33 | nF | ±10% | 0.60 | ±0.15 | ±0.15 | 2.5% | | (I) |
| | C2012X7R393KGTS | C2012X7R393KGT | 1V, 1kHz | 39 | nF | ±10% | 0.60 | ±0.15 | ±0.15 | 2.5% | | (I) |
| | C2012X7R473KGTS | C2012X7R473KGT | 1V, 1kHz | 47 | nF | ±10% | 0.60 | ±0.15 | ±0.15 | 2.5% | | (I) |
| | C2012X7R563KGTS | C2012X7R563KGT | 1V, 1kHz | 56 | nF | ±10% | 0.60 | ±0.15 | ±0.15 | 2.5% | | (I) |
| | C2012X7R683KGTS | C2012X7R683KGT | 1V, 1kHz | 68 | nF | ±10% | 0.60 | ±0.15 | ±0.15 | 2.5% | | (I) |
| | C2012X7R823KGTS | C2012X7R823KGT | 1V, 1kHz | 82 | nF | ±10% | 0.60 | ±0.15 | ±0.15 | 2.5% | | (I) |
| | C2012X7R104KGTS | C2012X7R104KGT | 1V, 1kHz | 100 | nF | ±10%,±5% | 0.80 | ±0.15 | ±0.10 | 2.5% | | (I) |
| | C2012X7R124KGTS | C2012X7R124KGT | 1V, 1kHz | 120 | nF | ±10% | 0.85 | ±0.15 | ±0.15 | 2.5% | | (I) |
| | C2012X7R154KGTS | C2012X7R154KGT | 1V, 1kHz | 150 | nF | ±10% | 0.85 | ±0.15 | ±0.15 | 2.5% | | (I) |
| | C2012X7R184KGTS | C2012X7R184KGT | 1V, 1kHz | 180 | nF | ±10% | 1.25 | ±0.15 | ±0.20 | 3.0% | | (I) |
| | C2012X7R224KGTS | C2012X7R224KGT | 1V, 1kHz | 220 | nF | ±10% | 0.85 | ±0.15 | ±0.15 | 3.0% | | (I) |
| | C2012X7R224KGPS | C2012X7R224KGP | 1V, 1kHz | 220 | nF | ±10% | 1.25 | ±0.15 | ±0.20 | 3.0% | (I) | |
| | C2012X7R334KGPS | C2012X7R334KGP | 1V, 1kHz | 330 | nF | ±10% | 1.25 | ±0.15 | ±0.20 | 3.0% | (I) | |
| | C2012X7R474KGPS | C2012X7R474KGP | 1V, 1kHz | 470 | nF | ±10% | 1.25 | ±0.15 | ±0.20 | 3.5% | (I) | |
| | C2012X7R105KGPS | C2012X7R105KGP | 1V, 1kHz | 1.0 | uF | ±10% | 1.25 | ±0.15 | ±0.20 | 10.0% | (II) | |
| | C2012X7R225KGPS | C2012X7R225KGP | 1V, 1kHz | 2.2 | uF | ±10% | 1.25 | ±0.20 | ±0.20 | 10.0% | (II) | |

MLCC
General Purpose

| RV | DARFON P/N | DARFON P/N 2 | Measuring Condition | Capacitance Value | Unit | Available Tolerance | Thick. (mm) | Tolerance(mm) | | DF (max.) | Standard Packing | Test Spec. |
|------------------|------------------|----------------|---------------------|-------------------|------------|---------------------|-------------|---------------|--------|-----------------|------------------|------------|
| | | | | | | | | L/W | Thick. | | | |
| 35V | C2012X7R474KNPS | C2012X7R474KNP | 1V, 1kHz | 470 | nF | ±10% | 1.25 | ±0.15 | ±0.20 | 3.5% | Embossed, 3Kpcs | (I) |
| | C2012X7R102KFTSC | | 1V, 1kHz | 1.0 | nF | ±10% | 0.60 | ±0.15 | ±0.15 | 3.5% | | (I) |
| | C2012X7R102KFTS | C2012X7R102KFT | 1V, 1kHz | 1.0 | nF | ±10% | 0.85 | ±0.15 | ±0.15 | 3.5% | | (I) |
| | C2012X7R122KFTSC | | 1V, 1kHz | 1.2 | nF | ±10% | 0.60 | ±0.15 | ±0.15 | 3.5% | | (I) |
| | C2012X7R122KFTS | C2012X7R122KFT | 1V, 1kHz | 1.2 | nF | ±10% | 0.85 | ±0.15 | ±0.15 | 3.5% | | (I) |
| | C2012X7R152KFTSC | | 1V, 1kHz | 1.5 | nF | ±10% | 0.60 | ±0.15 | ±0.15 | 3.5% | | (I) |
| | C2012X7R152KFTS | C2012X7R152KFT | 1V, 1kHz | 1.5 | nF | ±10% | 0.85 | ±0.15 | ±0.15 | 3.5% | | (I) |
| | C2012X7R182KFTSC | | 1V, 1kHz | 1.8 | nF | ±10% | 0.60 | ±0.15 | ±0.15 | 3.5% | | (I) |
| | C2012X7R182KFTS | C2012X7R182KFT | 1V, 1kHz | 1.8 | nF | ±10% | 0.85 | ±0.15 | ±0.15 | 3.5% | | (I) |
| | C2012X7R222KFTSC | | 1V, 1kHz | 2.2 | nF | ±10% | 0.60 | ±0.15 | ±0.15 | 3.5% | | (I) |
| | C2012X7R222KFTS | C2012X7R222KFT | 1V, 1kHz | 2.2 | nF | ±10% | 0.85 | ±0.15 | ±0.15 | 3.5% | | (I) |
| | C2012X7R272KFTSC | | 1V, 1kHz | 2.7 | nF | ±10% | 0.60 | ±0.15 | ±0.15 | 3.5% | | (I) |
| | C2012X7R272KFTS | C2012X7R272KFT | 1V, 1kHz | 2.7 | nF | ±10% | 0.85 | ±0.15 | ±0.15 | 3.5% | | (I) |
| | C2012X7R332KFTSC | | 1V, 1kHz | 3.3 | nF | ±10% | 0.60 | ±0.15 | ±0.15 | 3.5% | | (I) |
| | C2012X7R332KFTS | C2012X7R332KFT | 1V, 1kHz | 3.3 | nF | ±10% | 0.85 | ±0.15 | ±0.15 | 3.5% | | (I) |
| | C2012X7R392KFTSC | | 1V, 1kHz | 3.9 | nF | ±10% | 0.60 | ±0.15 | ±0.15 | 3.5% | | (I) |
| | C2012X7R392KFTS | C2012X7R392KFT | 1V, 1kHz | 3.9 | nF | ±10% | 0.85 | ±0.15 | ±0.15 | 3.5% | | (I) |
| | C2012X7R472KFTSC | | 1V, 1kHz | 4.7 | nF | ±10% | 0.60 | ±0.15 | ±0.15 | 3.5% | | (I) |
| | C2012X7R472KFTS | C2012X7R472KFT | 1V, 1kHz | 4.7 | nF | ±10% | 0.85 | ±0.15 | ±0.15 | 3.5% | | (I) |
| | C2012X7R562KFTSC | | 1V, 1kHz | 5.6 | nF | ±10% | 0.60 | ±0.15 | ±0.15 | 3.5% | | (I) |
| | C2012X7R562KFTS | C2012X7R562KFT | 1V, 1kHz | 5.6 | nF | ±10% | 0.85 | ±0.15 | ±0.15 | 3.5% | | (I) |
| | C2012X7R682KFTSC | | 1V, 1kHz | 6.8 | nF | ±10% | 0.60 | ±0.15 | ±0.15 | 3.5% | | (I) |
| | C2012X7R682KFTS | C2012X7R682KFT | 1V, 1kHz | 6.8 | nF | ±10% | 0.85 | ±0.15 | ±0.15 | 3.5% | | (I) |
| | C2012X7R822KFTSC | | 1V, 1kHz | 8.2 | nF | ±10% | 0.60 | ±0.15 | ±0.15 | 3.5% | | (I) |
| | C2012X7R103KFTSC | | 1V, 1kHz | 10 | nF | ±10% | 0.60 | ±0.15 | ±0.15 | 3.5% | | (I) |
| | C2012X7R103KFTS | C2012X7R103KFT | 1V, 1kHz | 10 | nF | ±10% | 0.85 | ±0.15 | ±0.15 | 3.5% | | (I) |
| | C2012X7R123KFTSC | | 1V, 1kHz | 12 | nF | ±10% | 0.60 | ±0.15 | ±0.15 | 3.5% | | (I) |
| | C2012X7R123KFTS | C2012X7R123KFT | 1V, 1kHz | 12 | nF | ±10% | 0.85 | ±0.15 | ±0.15 | 3.5% | | (I) |
| | C2012X7R153KFTSC | | 1V, 1kHz | 15 | nF | ±10% | 0.60 | ±0.15 | ±0.15 | 3.5% | | (I) |
| | C2012X7R153KFTS | C2012X7R153KFT | 1V, 1kHz | 15 | nF | ±10% | 0.85 | ±0.15 | ±0.15 | 3.5% | | (I) |
| | C2012X7R183KFTSC | | 1V, 1kHz | 18 | nF | ±10% | 0.60 | ±0.15 | ±0.15 | 3.5% | | (I) |
| | C2012X7R183KFTS | C2012X7R183KFT | 1V, 1kHz | 18 | nF | ±10% | 0.85 | ±0.15 | ±0.15 | 3.5% | | (I) |
| | C2012X7R223KFTSC | | 1V, 1kHz | 22 | nF | ±10% | 0.60 | ±0.15 | ±0.15 | 3.5% | | (I) |
| | C2012X7R223KFTS | C2012X7R223KFT | 1V, 1kHz | 22 | nF | ±10% | 0.85 | ±0.15 | ±0.15 | 3.5% | | (I) |
| | C2012X7R273KFTSC | | 1V, 1kHz | 27 | nF | ±10% | 0.60 | ±0.15 | ±0.15 | 3.5% | | (I) |
| C2012X7R273KFTS | C2012X7R273KFT | 1V, 1kHz | 27 | nF | ±10% | 0.85 | ±0.15 | ±0.15 | 3.5% | (I) | | |
| C2012X7R333KFTSC | | 1V, 1kHz | 33 | nF | ±10% | 0.60 | ±0.15 | ±0.15 | 3.5% | (I) | | |
| C2012X7R333KFTS | C2012X7R333KFT | 1V, 1kHz | 33 | nF | ±10% | 0.85 | ±0.15 | ±0.15 | 3.5% | (I) | | |
| C2012X7R393KFTSC | | 1V, 1kHz | 39 | nF | ±10% | 0.60 | ±0.15 | ±0.15 | 3.5% | (I) | | |
| C2012X7R393KFTS | C2012X7R393KFT | 1V, 1kHz | 39 | nF | ±10% | 0.85 | ±0.15 | ±0.15 | 3.5% | (I) | | |
| C2012X7R473KFTS | C2012X7R473KFT | 1V, 1kHz | 47 | nF | ±10% | 0.85 | ±0.15 | ±0.15 | 3.5% | (I) | | |
| C2012X7R563KFTS | C2012X7R563KFT | 1V, 1kHz | 56 | nF | ±10% | 0.85 | ±0.15 | ±0.15 | 3.5% | (I) | | |
| C2012X7R683KFTS | C2012X7R683KFT | 1V, 1kHz | 68 | nF | ±10% | 0.85 | ±0.15 | ±0.15 | 3.5% | (I) | | |
| C2012X7R823KFTS | C2012X7R823KFT | 1V, 1kHz | 82 | nF | ±10% | 0.85 | ±0.15 | ±0.15 | 3.5% | (I) | | |
| C2012X7R104KFTS | C2012X7R104KFT | 1V, 1kHz | 100 | nF | ±10% | 0.85 | ±0.15 | ±0.15 | 3.5% | (I) | | |
| C2012X7R124KFTS | C2012X7R124KFT | 1V, 1kHz | 120 | nF | ±10% | 0.85 | ±0.15 | ±0.15 | 3.5% | (I) | | |
| C2012X7R154KFTS | C2012X7R154KFT | 1V, 1kHz | 150 | nF | ±10% | 0.85 | ±0.15 | ±0.15 | 3.5% | (I) | | |
| C2012X7R184KFTS | C2012X7R184KFT | 1V, 1kHz | 180 | nF | ±10% | 0.85 | ±0.15 | ±0.20 | 3.5% | (I) | | |
| C2012X7R224KFTS | C2012X7R224KFT | 1V, 1kHz | 220 | nF | ±10% | 0.85 | ±0.15 | ±0.15 | 3.5% | (I) | | |
| C2012X7R334KFPS | C2012X7R334KFP | 1V, 1kHz | 330 | nF | ±10% | 1.25 | ±0.15 | ±0.20 | 5.0% | (I) | | |
| C2012X7R474KFPS | C2012X7R474KFP | 1V, 1kHz | 470 | nF | ±10% | 1.25 | ±0.15 | ±0.20 | 5.0% | (I) | | |
| C2012X7R105□FPS | C2012X7R105□FP | 1V, 1kHz | 1.0 | uF | ±10%, ±20% | 1.25 | ±0.15 | ±0.15 | 10.0% | Embossed, 3Kpcs | (II) | |
| C2012X7R225KFPS | C2012X7R225KFP | 1V, 1kHz | 2.2 | uF | ±10% | 1.25 | ±0.15 | ±0.20 | 10.0% | (II) | | |
| C2012X7R475KFPS | C2012X7R475KFP | 1V, 1kHz | 4.7 | uF | ±10% | 1.25 | ±0.15 | ±0.15 | 12.5% | (II)* | | |
| C2012X7R123KETS | C2012X7R123KET | 1V, 1kHz | 12 | nF | ±10% | 0.85 | ±0.15 | ±0.15 | 3.5% | (I) | | |
| C2012X7R104KETS | C2012X7R104KET | 1V, 1kHz | 100 | nF | ±10% | 0.85 | ±0.15 | ±0.15 | 3.5% | Paper, 4Kpcs | (I) | |
| C2012X7R224KETS | C2012X7R224KET | 1V, 1kHz | 220 | nF | ±10% | 0.85 | ±0.15 | ±0.15 | 3.5% | (I) | | |
| C2012X7R224KEPS | C2012X7R224KEP | 1V, 1kHz | 220 | nF | ±10% | 1.25 | ±0.15 | ±0.20 | 3.0% | (I) | | |
| C2012X7R334KEPS | C2012X7R334KEP | 1V, 1kHz | 330 | nF | ±10% | 1.25 | ±0.15 | ±0.20 | 5.0% | (I) | | |
| C2012X7R474KEPS | C2012X7R474KEP | 1V, 1kHz | 470 | nF | ±10% | 1.25 | ±0.15 | ±0.20 | 5.0% | (I) | | |
| C2012X7R684KEPS | C2012X7R684KEP | 1V, 1kHz | 680 | nF | ±10% | 1.25 | ±0.15 | ±0.10 | 5.0% | Embossed, 3Kpcs | (I) | |
| C2012X7R105□EPS | C2012X7R105□EP | 1V, 1kHz | 1.0 | uF | ±10%, ±20% | 1.25 | ±0.15 | ±0.20 | 5.0% | (I) | | |
| C2012X7R225KEPS | C2012X7R225KEP | 1V, 1kHz | 2.2 | uF | ±10% | 1.25 | ±0.15 | ±0.20 | 10.0% | (I) | | |
| C2012X7R475KEPS | C2012X7R475KEP | 1V, 1kHz | 4.7 | uF | ±10% | 1.25 | ±0.15 | ±0.20 | 10.0% | (II) | | |
| C2012X7R105□DPS | C2012X7R105□DP | 1V, 1kHz | 1.0 | uF | ±10%, ±20% | 1.25 | ±0.15 | ±0.20 | 5.0% | (I) | | |
| C2012X7R225KDPS | C2012X7R225KDP | 1V, 1kHz | 2.2 | uF | ±10% | 1.25 | ±0.15 | ±0.20 | 10.0% | Embossed, 3Kpcs | (II) | |
| C2012X7R475KDPS | C2012X7R475KDP | 1V, 1kHz | 4.7 | uF | ±10% | 1.25 | ±0.15 | ±0.20 | 10.0% | (II) | | |
| C2012X7R106KDPS | C2012X7R106KDP | 1V, 1kHz | 10 | uF | ±10% | 1.25 | ±0.15 | ±0.20 | 10.0% | (II) | | |
| C2012X7R475KCPS | C2012X7R475KCP | 1V, 1kHz | 4.7 | uF | ±10% | 1.25 | ±0.15 | ±0.20 | 10.0% | Embossed, 3Kpcs | (II) | |
| C2012X7R106□CPS | C2012X7R106□CP | 1V, 1kHz | 10 | uF | ±10%, ±20% | 1.25 | ±0.15 | ±0.20 | 15.0% | (II) | | |
| 4V | C2012X7R106□BPS | C2012X7R106□BP | 1V, 1kHz | 10 | uF | ±10%, ±20% | 1.25 | ±0.15 | ±0.20 | 15.0% | Embossed, 3Kpcs | (II) |

● C3216X7R Series (EIA1206)

| RV | DARFON P/N | DARFON P/N 2 | Measuring Condition | Capacitance | | Available Tolerance | Thick. (mm) | Tolerance(mm) | | DF (max.) | Standard Packing | Test Spec. |
|------------------|------------------|----------------|---------------------|-------------|------------|---------------------|-------------|---------------|-----------|-----------------|------------------|------------|
| | | | | Value | Unit | | | LW | Thick. | | | |
| 50V | C3216X7R102KGTS | C3216X7R102KGT | 1V, 1kHz | 1.0 | nF | ±10% | 0.85 | ±0.15 | ±0.10 | 3.5% | Paper, 4Kpcs | (I) |
| | C3216X7R562□GTS | C3216X7R562□GT | 1V, 1kHz | 5.6 | nF | ±5%, ±10% | 0.85 | ±0.15 | ±0.10 | 3.5% | | (I) |
| | C3216X7R103□GTS | C3216X7R103□GT | 1V, 1kHz | 10 | nF | ±10%, ±20% | 0.85 | ±0.15 | ±0.10 | 3.5% | | (I) |
| | C3216X7R123KGTS | C3216X7R123KGT | 1V, 1kHz | 12 | nF | ±10% | 0.85 | ±0.15 | ±0.10 | 3.5% | | (I) |
| | C3216X7R153KGTS | C3216X7R153KGT | 1V, 1kHz | 15 | nF | ±10% | 0.85 | ±0.15 | ±0.10 | 3.5% | | (I) |
| | C3216X7R183KGTS | C3216X7R183KGT | 1V, 1kHz | 18 | nF | ±10% | 0.85 | ±0.15 | ±0.10 | 3.5% | | (I) |
| | C3216X7R223KGTS | C3216X7R223KGT | 1V, 1kHz | 22 | nF | ±10% | 0.85 | ±0.15 | ±0.10 | 3.5% | | (I) |
| | C3216X7R273KGTS | C3216X7R273KGT | 1V, 1kHz | 27 | nF | ±10% | 0.85 | ±0.15 | ±0.10 | 3.5% | | (I) |
| | C3216X7R333KGTS | C3216X7R333KGT | 1V, 1kHz | 33 | nF | ±10% | 0.85 | ±0.15 | ±0.10 | 3.5% | | (I) |
| | C3216X7R393KGTS | C3216X7R393KGT | 1V, 1kHz | 39 | nF | ±10% | 0.85 | ±0.15 | ±0.10 | 3.5% | | (I) |
| | C3216X7R473KGTS | C3216X7R473KGT | 1V, 1kHz | 47 | nF | ±10% | 0.85 | ±0.15 | ±0.10 | 3.5% | | (I) |
| | C3216X7R563KGTS | C3216X7R563KGT | 1V, 1kHz | 56 | nF | ±10% | 0.85 | ±0.15 | ±0.10 | 3.5% | | (I) |
| | C3216X7R683KGTS | C3216X7R683KGT | 1V, 1kHz | 68 | nF | ±10% | 0.85 | ±0.15 | ±0.10 | 3.5% | (I) | |
| | C3216X7R823KGTS | C3216X7R823KGT | 1V, 1kHz | 82 | nF | ±10% | 0.85 | ±0.15 | ±0.10 | 3.5% | (I) | |
| | C3216X7R104KGTS | C3216X7R104KGT | 1V, 1kHz | 100 | nF | ±10% | 0.85 | ±0.15 | ±0.10 | 3.5% | (I) | |
| | C3216X7R224KGPS | C3216X7R224KGP | 1V, 1kHz | 220 | nF | ±10% | 0.95 | ±0.15 | ±0.10 | 3.5% | (I) | |
| | C3216X7R334□GPS | C3216X7R334□GP | 1V, 1kHz | 330 | nF | ±5%, ±10% | 1.25 | ±0.15 | ±0.15 | 3.5% | Embossed, 3Kpcs | (I) |
| | C3216X7R474KGPS | C3216X7R474KGP | 1V, 1kHz | 470 | nF | ±10% | 1.25 | ±0.15 | ±0.15 | 3.5% | (I) | |
| | C3216X7R474KGPS | C3216X7R474KGP | 1V, 1kHz | 470 | nF | ±10% | 1.60 | ±0.15 | ±0.20 | 3.5% | Embossed, 2Kpcs | (I) |
| | C3216X7R684KGPS | C3216X7R684KGP | 1V, 1kHz | 680 | nF | ±10% | 1.60 | +0.3/-0.1 | +0.3/-0.1 | 3.5% | (I) | |
| C3216X7R105KGPS | C3216X7R105KGP | 1V, 1kHz | 1.0 | uF | ±10% | 1.25 | ±0.15 | ±0.15 | 3.5% | Embossed, 3Kpcs | (I) | |
| C3216X7R105KGPS | C3216X7R105KGP | 1V, 1kHz | 1.0 | uF | ±10% | 1.60 | ±0.30 | ±0.30 | 3.5% | (I) | | |
| C3216X7R225KGPSL | C3216X7R225KGP | 1V, 1kHz | 2.2 | uF | ±10% | 1.60 | ±0.20 | ±0.20 | 10.0% | Embossed, 2Kpcs | (II) | |
| C3216X7R475KGPS | C3216X7R475KGP | 1V, 1kHz | 4.7 | uF | ±10% | 1.60 | ±0.30 | ±0.30 | 10.0% | (II) | | |
| C3216X7R106KGPSL | C3216X7R106KGP | 1V, 1kHz | 10 | uF | ±10% | 1.60 | ±0.20 | ±0.20 | 10.0% | (II) | | |
| 35V | C3216X7R106KNPSL | C3216X7R106KNP | 1V, 1kHz | 10 | uF | ±10% | 1.60 | ±0.20 | ±0.20 | 10.0% | Embossed, 2Kpcs | (II) |
| 25V | C3216X7R224KFPS | C3216X7R224KFP | 1V, 1kHz | 220 | nF | ±10% | 0.95 | ±0.15 | ±0.10 | 3.5% | Embossed, 3Kpcs | (I) |
| | C3216X7R334KFPS | C3216X7R334KFP | 1V, 1kHz | 330 | nF | ±10% | 0.95 | ±0.15 | ±0.10 | 3.5% | | (I) |
| | C3216X7R474KFPS | C3216X7R474KFP | 1V, 1kHz | 470 | nF | ±10% | 1.25 | ±0.15 | ±0.20 | 3.5% | | (I) |
| | C3216X7R105□FPS | C3216X7R105□FP | 1V, 1kHz | 1.0 | uF | ±10%, ±20% | 1.25 | ±0.15 | ±0.20 | 3.5% | (I) | |
| | C3216X7R225KFPS | C3216X7R225KFP | 1V, 1kHz | 2.2 | uF | ±10% | 1.60 | ±0.30 | ±0.30 | 5.0% | (I) | |
| | C3216X7R475KFPS | C3216X7R475KFP | 1V, 1kHz | 4.7 | uF | ±10% | 1.60 | ±0.30 | ±0.30 | 10.0% | Embossed, 2Kpcs | (I) |
| C3216X7R106KFPS | C3216X7R106KFP | 1V, 1kHz | 10 | uF | ±10% | 1.60 | ±0.30 | ±0.30 | 10.0% | (II) | | |
| 16V | C3216X7R104KETS | C3216X7R104KET | 1V, 1kHz | 100 | nF | ±10% | 0.85 | ±0.15 | ±0.10 | 3.5% | Paper, 4Kpcs | (I) |
| | C3216X7R474KEPS | C3216X7R474KEP | 1V, 1kHz | 470 | nF | ±10% | 1.25 | ±0.15 | ±0.20 | 5.0% | Embossed, 3Kpcs | (I) |
| | C3216X7R105KEPS | C3216X7R105KEP | 1V, 1kHz | 1.0 | uF | ±10% | 1.25 | ±0.15 | ±0.20 | 5.0% | | (I) |
| | C3216X7R225KEPS | C3216X7R225KEP | 1V, 1kHz | 2.2 | uF | ±10% | 1.60 | ±0.30 | ±0.30 | 10.0% | (I) | |
| | C3216X7R475□EPS | C3216X7R475□EP | 1V, 1kHz | 4.7 | uF | ±10%, ±20% | 1.60 | ±0.30 | ±0.30 | 10.0% | (I) | |
| C3216X7R106□EPS | C3216X7R106□EP | 1V, 1kHz | 10 | uF | ±10%, ±20% | 1.60 | ±0.30 | ±0.30 | 10.0% | (II)* | | |
| 10V | C3216X7R225KDPS | C3216X7R225KDP | 1V, 1kHz | 2.2 | uF | ±10% | 1.60 | ±0.30 | ±0.30 | 10.0% | Embossed, 2Kpcs | (I) |
| | C3216X7R106□DPS | C3216X7R106□DP | 1V, 1kHz | 10 | uF | ±10%, ±20% | 1.60 | ±0.30 | ±0.30 | 10.0% | | (II) |
| | C3216X7R226□DPS | C3216X7R226□DP | 0.5V, 120Hz | 22 | uF | ±10%, ±20% | 1.60 | ±0.30 | ±0.30 | 10.0% | | (II) |
| 6.3V | C3216X7R226KCPS | C3216X7R226KCP | 0.5V, 120Hz | 22 | uF | ±10% | 1.60 | ±0.30 | ±0.30 | 10.0% | (II) | |

● C3225X7R Series (EIA1210)

| RV | DARFON P/N | DARFON P/N 2 | Measuring Condition | Capacitance | | Available Tolerance | Thick. (mm) | Tolerance(mm) | | DF (max.) | Standard Packing | Test Spec. |
|-----|-----------------|----------------|---------------------|-------------|------|---------------------|-------------|---------------|--------|-----------|------------------|------------|
| | | | | Value | Unit | | | LW | Thick. | | | |
| 50V | C3225X7R225MGPS | C3225X7R225MGP | 1V, 1kHz | 2.2 | uF | ±20% | 2.50 | ±0.3/±0.2 | ±0.20 | 5.0% | Embossed, 1Kpcs | (II) |
| | C3225X7R475KGPS | C3225X7R475KGP | 1V, 1kHz | 4.7 | uF | ±10% | 2.50 | ±0.3/±0.2 | ±0.20 | 10.0% | | (II) |
| | C3225X7R106KGWS | C3225X7R106KGW | 1V, 1kHz | 10 | uF | ±10% | 2.00 | ±0.3/±0.2 | ±0.20 | 15.0% | | (II) |
| | C3225X7R106□GPS | C3225X7R106□GP | 1V, 1kHz | 10 | uF | ±10%, ±20% | 2.50 | ±0.30 | ±0.30 | 10.0% | | (II) |
| 35V | C3225X7R106KNPS | C3225X7R106KNP | 1V, 1kHz | 10 | uF | ±10% | 2.50 | ±0.30 | ±0.30 | 10.0% | Embossed, 1Kpcs | (II) |
| 25V | C3225X7R475KFPS | C3225X7R475KFP | 1V, 1kHz | 4.7 | uF | ±10% | 2.00 | ±0.3/±0.2 | ±0.20 | 10.0% | Embossed, 2Kpcs | (I) |
| | C3225X7R106KFPS | C3225X7R106KFP | 1V, 1kHz | 10 | uF | ±10% | 2.00 | ±0.3/±0.2 | ±0.30 | 10.0% | | (II) |
| | C3225X7R226□FPS | C3225X7R226□FP | 0.5V, 120Hz | 22 | uF | ±10%, ±20% | 2.50 | ±0.3/±0.2 | ±0.20 | 10.0% | Embossed, 1Kpcs | (II) |
| 16V | C3225X7R475KEPS | C3225X7R475KEP | 1V, 1kHz | 4.7 | uF | ±10% | 2.50 | ±0.3/±0.2 | ±0.20 | 5.0% | Embossed, 1Kpcs | (II) |
| | C3225X7R106KEPS | C3225X7R106KEP | 1V, 1kHz | 10 | uF | ±10% | 2.00 | ±0.3/±0.2 | ±0.20 | 10.0% | Embossed, 2Kpcs | (I) |
| | C3225X7R226□EPS | C3225X7R226□EP | 0.5V, 120Hz | 22 | uF | ±10%, ±20% | 2.50 | ±0.3/±0.2 | ±0.30 | 10.0% | Embossed, 1Kpcs | (II) |
| 10V | C3225X7R226KDPS | C3225X7R226KDP | 0.5V, 120Hz | 22 | uF | ±10% | 2.50 | ±0.3/±0.2 | ±0.20 | 10.0% | Embossed, 1Kpcs | (II) |
| | C3225X7R476□DPS | C3225X7R476□DP | 0.5V, 120Hz | 47 | uF | ±10%, ±20% | 2.50 | ±0.3/±0.2 | ±0.20 | 10.0% | | (II) |

□ Tolerance Code: J=±5%, K=±10%, M=±20%; Special tolerance on the request.

(II)* High temperature load life test are applicable in rated voltage *100%

- X7S Series
- C0603X7S Series (EIA0201)

| RV | DARFON P/N | DARFON P/N 2 | Measuring Condition | Capacitance | | Available Tolerance | Thick. (mm) | Tolerance(mm) | | DF (max.) | Standard Packing | Test Spec. |
|------|-----------------|----------------|---------------------|-------------|------|---------------------|-------------|---------------|--------|-----------|------------------|------------|
| | | | | Value | Unit | | | L/W | Thick. | | | |
| 16V | C0603X7S104□ETS | C0603X7S104□ET | 1V, 1kHz | 100 | nF | ±10%,±20% | 0.30 | ± 0.03 | ±0.03 | 10.0% | Paper, 15Kpcs | (II)* |
| 10V | C0603X7S104KDTS | C0603X7S104KDT | 1V, 1kHz | 100 | nF | ±10% | 0.30 | ± 0.03 | ±0.03 | 10.0% | Paper, 15Kpcs | (II) |
| 6.3V | C0603X7S104KCTS | C0603X7S104KCT | 1V, 1kHz | 100 | nF | ±10% | 0.30 | ± 0.03 | ±0.03 | 10.0% | Paper, 15Kpcs | (II) |

- C1005X7S Series (EIA0402)

| RV | DARFON P/N | DARFON P/N 2 | Measuring Condition | Capacitance | | Available Tolerance | Thick. (mm) | Tolerance(mm) | | DF (max.) | Standard Packing | Test Spec. |
|------|-----------------|----------------|---------------------|-------------|------|---------------------|-------------|---------------|--------|-----------|------------------|------------|
| | | | | Value | Unit | | | L/W | Thick. | | | |
| 10V | C1005X7S105KDTS | C1005X7S105KDT | 1V, 1kHz | 1.0 | uF | ±10% | 0.50 | ± 0.10 | ±0.10 | 10.0% | Paper, 10Kpcs | (II) |
| | C1005X7S225KDTS | C1005X7S225KDT | 1V, 1kHz | 2.2 | uF | ±10% | 0.50 | ± 0.20 | ±0.20 | 10.0% | | (II) |
| 6.3V | C1005X7S225KCTS | C1005X7S225KCT | 1V, 1kHz | 2.2 | uF | ±10% | 0.50 | ± 0.20 | ±0.20 | 10.0% | | (II) |

- C1608X7S Series (EIA0603)

| RV | DARFON P/N | DARFON P/N 2 | Measuring Condition | Capacitance | | Available Tolerance | Thick. (mm) | Tolerance(mm) | | DF (max.) | Standard Packing | Test Spec. |
|-----|-----------------|----------------|---------------------|-------------|------|---------------------|-------------|---------------|--------|-----------|------------------|------------|
| | | | | Value | Unit | | | L/W | Thick. | | | |
| 16V | C1608X7S225KETS | C1608X7S225KET | 1V, 1kHz | 2.2 | uF | ±10% | 0.80 | ± 0.20 | ±0.20 | 10.0% | Paper, 4Kpcs | (II) |
| | C1608X7S475KETS | C1608X7S475KET | 1V, 1kHz | 4.7 | uF | ±10% | 0.80 | ± 0.20 | ±0.20 | 10.0% | | (II) |
| 10V | C1608X7S475KDTS | C1608X7S475KDT | 1V, 1kHz | 4.7 | uF | ±10% | 0.80 | ± 0.15 | ±0.15 | 10.0% | | (II) |

- C2012X7S Series (EIA0805)

| RV | DARFON P/N | DARFON P/N 2 | Measuring Condition | Capacitance | | Available Tolerance | Thick. (mm) | Tolerance(mm) | | DF (max.) | Standard Packing | Test Spec. |
|-----|-----------------|----------------|---------------------|-------------|------|---------------------|-------------|---------------|--------|-----------|------------------|------------|
| | | | | Value | Unit | | | L/W | Thick. | | | |
| 50V | C2012X7S475KGPS | C2012X7S475KGP | 1V, 1kHz | 4.7 | uF | ±10% | 1.25 | ± 0.20 | ±0.20 | 10.0% | Embossed, 3Kpcs | (II) |
| 25V | C2012X7S225KFPS | C2012X7S225KFP | 1V, 1kHz | 2.2 | uF | ±10% | 1.25 | ± 0.15 | ±0.15 | 10.0% | | (II) |
| | C2012X7S106□FPS | C2012X7S106□FP | 1V, 1kHz | 10 | uF | ±10%,±20% | 1.25 | ± 0.20 | ±0.20 | 10.0% | | (II)* |

- C3225X7S Series (EIA1210)

| RV | DARFON P/N | DARFON P/N 2 | Measuring Condition | Capacitance | | Available Tolerance | Thick. (mm) | Tolerance(mm) | | DF (max.) | Standard Packing | Test Spec. |
|------|-----------------|----------------|---------------------|-------------|------|---------------------|-------------|---------------|--------|-----------|------------------|------------|
| | | | | Value | Unit | | | L/W | Thick. | | | |
| 6.3V | C3225X7S107MCPS | C3225X7S107MCP | 0.5V, 100Hz | 100 | uF | ±20% | 2.50 | ± 0.30 | ±0.30 | 10.0% | Embossed, 1Kpcs | (II)* |

□ Tolerance Code: K=±10%, M=±20%; Special tolerance on the request.

(II)* High temperature load life test are applicable in rated voltage *100%

■ X7T Series

● C1608X7T Series (EIA0603)

| RV | DARFON P/N | DARFON P/N 2 | Measuring Condition | Capacitance | | Available Tolerance | Thick. (mm) | Tolerance(mm) | | DF (max.) | Standard Packing | Test Spec. |
|------|-----------------|----------------|---------------------|-------------|------|---------------------|-------------|---------------|--------|-----------|------------------|------------|
| | | | | Value | Unit | | | L/W | Thick. | | | |
| 6.3V | C1608X7T106MCTS | C1608X7T106MCT | 1V , 1kHz | 10 | uF | ±20% | 0.80 | ± 0.20 | ±0.20 | 10.0% | Paper, 4Kpcs | (II) |

● C2012X7T Series (EIA0805)

| RV | DARFON P/N | DARFON P/N 2 | Measuring Condition | Capacitance | | Available Tolerance | Thick. (mm) | Tolerance(mm) | | DF (max.) | Standard Packing | Test Spec. |
|------|-----------------|----------------|---------------------|-------------|------|---------------------|-------------|---------------|--------|-----------|------------------|------------|
| | | | | Value | Unit | | | L/W | Thick. | | | |
| 10V | C2012X7T226MDPS | C2012X7T226MDP | 0.5V , 120Hz | 22 | uF | ±20% | 1.25 | ± 0.20 | ±0.20 | 10.0% | Embossed, 3Kpcs | (II)* |
| 6.3V | C2012X7T226MCPS | C2012X7T226MCP | 0.5V , 120Hz | 22 | uF | ±20% | 1.25 | ± 0.20 | ±0.20 | 10.0% | Embossed, 3Kpcs | (II) |

□ Tolerance Code: K=±10%, M=±20%; Special tolerance on the request.

(II)* High temperature load life test are applicable in rated voltage *100%

- X7U Series
- C3216X7U Series (EIA1206)

| RV | DARFON P/N | DARFON P/N 2 | Measuring Condition | Capacitance | | Available Tolerance | Thick. (mm) | Tolerance(mm) | | DF (max.) | Standard Packing | Test Spec. |
|------|-----------------|----------------|---------------------|-------------|------|---------------------|-------------|---------------|--------|-----------|------------------|------------|
| | | | | Value | Unit | | | L/W | Thick. | | | |
| 6.3V | C3216X7U476MCPS | C3216X7U476MCP | 0.5V , 120Hz | 47 | uF | ±20% | 1.60 | ± 0.30 | ±0.30 | 15.0% | Embossed, 2Kpcs | (II)* |
| 4V | C3216X7U107MBPS | C3216X7U107MBP | 0.5V , 120Hz | 100 | uF | ±20% | 1.60 | ± 0.30 | ±0.30 | 15.0% | Embossed, 2Kpcs | (II)* |

□ Tolerance Code: K=±10%, M=±20%; Special tolerance on the request.

(II)* High temperature load life test are applicable in rated voltage *100%

■ Y5V Series

● C1005Y5V Series (EIA0402)

| RV | DARFON P/N | DARFON P/N 2 | Measuring Condition | Capacitance | | Available Tolerance | Thick. (mm) | Tolerance(mm) | | DF (max.) | Standard Packing | Test Spec. |
|------|-----------------|----------------|---------------------|-------------|------|---------------------|-------------|---------------|--------|-----------|------------------|------------|
| | | | | Value | Unit | | | L/W | Thick. | | | |
| 50V | C1005Y5V103ZGTS | C1005Y5V103ZGT | 1V, 1kHz | 10 | nF | +80%/-20% | 0.50 | ±0.05 | ±0.05 | 7.0% | Paper, 10Kpcs | (I) |
| | C1005Y5V223ZGTS | C1005Y5V223ZGT | 1V, 1kHz | 22 | nF | +80%/-20% | 0.50 | ±0.05 | ±0.05 | 9.0% | | (II) |
| 25V | C1005Y5V103ZFTS | C1005Y5V103ZFT | 1V, 1kHz | 10 | nF | +80%/-20% | 0.50 | ±0.05 | ±0.05 | 9.0% | Paper, 10Kpcs | (I) |
| | C1005Y5V223ZFTS | C1005Y5V223ZFT | 1V, 1kHz | 22 | nF | +80%/-20% | 0.50 | ±0.05 | ±0.05 | 9.0% | | (II) |
| | C1005Y5V473ZFTS | C1005Y5V473ZFT | 1V, 1kHz | 47 | nF | +80%/-20% | 0.50 | ±0.05 | ±0.05 | 9.0% | | (III) |
| | C1005Y5V104JFTS | C1005Y5V104JFT | 1V, 1kHz | 100 | nF | ±20%, +80%/-20% | 0.50 | ±0.05 | ±0.05 | 9.0% | | (IV) |
| 16V | C1005Y5V473ZETS | C1005Y5V473ZET | 1V, 1kHz | 47 | nF | +80%/-20% | 0.50 | ±0.05 | ±0.05 | 9.0% | Paper, 10Kpcs | (I) |
| | C1005Y5V224ZETS | C1005Y5V224ZET | 1V, 1kHz | 220 | nF | +80%/-20% | 0.50 | ±0.05 | ±0.05 | 9.0% | | (II) |
| | C1005Y5V474ZETS | C1005Y5V474ZET | 1V, 1kHz | 470 | nF | +80%/-20% | 0.50 | ±0.05 | ±0.05 | 12.5% | | (III) |
| 10V | C1005Y5V224ZDTS | C1005Y5V224ZDT | 1V, 1kHz | 220 | nF | +80%/-20% | 0.50 | ±0.05 | ±0.05 | 12.5% | Paper, 10Kpcs | (I) |
| | C1005Y5V334ZDTS | C1005Y5V334ZDT | 1V, 1kHz | 330 | nF | +80%/-20% | 0.50 | ±0.05 | ±0.05 | 16.0% | | (II) |
| | C1005Y5V474ZDTS | C1005Y5V474ZDT | 1V, 1kHz | 470 | nF | +80%/-20% | 0.50 | ±0.05 | ±0.05 | 16.0% | | (III) |
| | C1005Y5V105ZDTS | C1005Y5V105ZDT | 1V, 1kHz | 1.0 | uF | +80%/-20% | 0.50 | ±0.05 | ±0.05 | 16.0% | | (IV) |
| 6.3V | C1005Y5V224ZCTS | C1005Y5V224ZCT | 1V, 1kHz | 220 | nF | +80%/-20% | 0.50 | ±0.05 | ±0.05 | 12.5% | Paper, 10Kpcs | (I) |
| | C1005Y5V334ZCTS | C1005Y5V334ZCT | 1V, 1kHz | 330 | nF | +80%/-20% | 0.50 | ±0.05 | ±0.05 | 16.0% | | (II) |
| | C1005Y5V474ZCTS | C1005Y5V474ZCT | 1V, 1kHz | 470 | nF | +80%/-20% | 0.50 | ±0.05 | ±0.05 | 16.0% | | (III) |
| | C1005Y5V105ZCTS | C1005Y5V105ZCT | 1V, 1kHz | 1.0 | uF | +80%/-20% | 0.50 | ±0.05 | ±0.05 | 16.0% | | (IV) |

● C1608Y5V Series (EIA0603)

| RV | DARFON P/N | DARFON P/N 2 | Measuring Condition | Capacitance | | Available Tolerance | Thick. (mm) | Tolerance(mm) | | DF (max.) | Standard Packing | Test Spec. |
|-----------------|-----------------|----------------|---------------------|-------------|-----------|---------------------|-------------|---------------|--------|-----------|------------------|------------|
| | | | | Value | Unit | | | L/W | Thick. | | | |
| 50V | C1608Y5V103ZGTS | C1608Y5V103ZGT | 1V, 1kHz | 10 | nF | +80%/-20% | 0.80 | ±0.10 | ±0.10 | 5.0% | Paper, 4Kpcs | (I) |
| | C1608Y5V123ZGTS | C1608Y5V123ZGT | 1V, 1kHz | 12 | nF | +80%/-20% | 0.80 | ±0.10 | ±0.10 | 5.0% | | (II) |
| | C1608Y5V153ZGTS | C1608Y5V153ZGT | 1V, 1kHz | 15 | nF | +80%/-20% | 0.80 | ±0.10 | ±0.10 | 5.0% | | (III) |
| | C1608Y5V183ZGTS | C1608Y5V183ZGT | 1V, 1kHz | 18 | nF | +80%/-20% | 0.80 | ±0.10 | ±0.10 | 5.0% | | (IV) |
| | C1608Y5V223ZGTS | C1608Y5V223ZGT | 1V, 1kHz | 22 | nF | +80%/-20% | 0.80 | ±0.10 | ±0.10 | 5.0% | | (V) |
| | C1608Y5V273ZGTS | C1608Y5V273ZGT | 1V, 1kHz | 27 | nF | +80%/-20% | 0.80 | ±0.10 | ±0.10 | 5.0% | | (VI) |
| | C1608Y5V333ZGTS | C1608Y5V333ZGT | 1V, 1kHz | 33 | nF | +80%/-20% | 0.80 | ±0.10 | ±0.10 | 5.0% | | (VII) |
| | C1608Y5V393ZGTS | C1608Y5V393ZGT | 1V, 1kHz | 39 | nF | +80%/-20% | 0.80 | ±0.10 | ±0.10 | 5.0% | | (VIII) |
| | C1608Y5V473ZGTS | C1608Y5V473ZGT | 1V, 1kHz | 47 | nF | +80%/-20% | 0.80 | ±0.10 | ±0.10 | 5.0% | | (IX) |
| | C1608Y5V563ZGTS | C1608Y5V563ZGT | 1V, 1kHz | 56 | nF | +80%/-20% | 0.80 | ±0.10 | ±0.10 | 5.0% | | (X) |
| | C1608Y5V683ZGTS | C1608Y5V683ZGT | 1V, 1kHz | 68 | nF | +80%/-20% | 0.80 | ±0.10 | ±0.10 | 5.0% | | (XI) |
| | C1608Y5V823ZGTS | C1608Y5V823ZGT | 1V, 1kHz | 82 | nF | +80%/-20% | 0.80 | ±0.10 | ±0.10 | 5.0% | | (XII) |
| | C1608Y5V104ZGTS | C1608Y5V104ZGT | 1V, 1kHz | 100 | nF | +80%/-20% | 0.80 | ±0.10 | ±0.10 | 7.0% | | (XIII) |
| | C1608Y5V224ZGTS | C1608Y5V224ZGT | 1V, 1kHz | 220 | nF | +80%/-20% | 0.80 | ±0.10 | ±0.10 | 9.0% | | (XIV) |
| C1608Y5V474ZGTS | C1608Y5V474ZGT | 1V, 1kHz | 470 | nF | +80%/-20% | 0.80 | ±0.15 | ±0.15 | 9.0% | (I) | | |
| 25V | C1608Y5V103ZFTS | C1608Y5V103ZFT | 1V, 1kHz | 10 | nF | +80%/-20% | 0.80 | ±0.10 | ±0.10 | 5.0% | Paper, 4Kpcs | (I) |
| | C1608Y5V123ZFTS | C1608Y5V123ZFT | 1V, 1kHz | 12 | nF | +80%/-20% | 0.80 | ±0.10 | ±0.10 | 5.0% | | (II) |
| | C1608Y5V153ZFTS | C1608Y5V153ZFT | 1V, 1kHz | 15 | nF | +80%/-20% | 0.80 | ±0.10 | ±0.10 | 5.0% | | (III) |
| | C1608Y5V183ZFTS | C1608Y5V183ZFT | 1V, 1kHz | 18 | nF | +80%/-20% | 0.80 | ±0.10 | ±0.10 | 5.0% | | (IV) |
| | C1608Y5V223ZFTS | C1608Y5V223ZFT | 1V, 1kHz | 22 | nF | +80%/-20% | 0.80 | ±0.10 | ±0.10 | 5.0% | | (V) |
| | C1608Y5V273ZFTS | C1608Y5V273ZFT | 1V, 1kHz | 27 | nF | +80%/-20% | 0.80 | ±0.10 | ±0.10 | 5.0% | | (VI) |
| | C1608Y5V333ZFTS | C1608Y5V333ZFT | 1V, 1kHz | 33 | nF | +80%/-20% | 0.80 | ±0.10 | ±0.10 | 5.0% | | (VII) |
| | C1608Y5V393ZFTS | C1608Y5V393ZFT | 1V, 1kHz | 39 | nF | +80%/-20% | 0.80 | ±0.10 | ±0.10 | 5.0% | | (VIII) |
| | C1608Y5V473ZFTS | C1608Y5V473ZFT | 1V, 1kHz | 47 | nF | +80%/-20% | 0.80 | ±0.10 | ±0.10 | 5.0% | | (IX) |
| | C1608Y5V563ZFTS | C1608Y5V563ZFT | 1V, 1kHz | 56 | nF | +80%/-20% | 0.80 | ±0.10 | ±0.10 | 5.0% | | (X) |
| | C1608Y5V683ZFTS | C1608Y5V683ZFT | 1V, 1kHz | 68 | nF | +80%/-20% | 0.80 | ±0.10 | ±0.10 | 5.0% | | (XI) |
| | C1608Y5V823ZFTS | C1608Y5V823ZFT | 1V, 1kHz | 82 | nF | +80%/-20% | 0.80 | ±0.10 | ±0.10 | 5.0% | | (XII) |
| | C1608Y5V104ZFTS | C1608Y5V104ZFT | 1V, 1kHz | 100 | nF | +80%/-20% | 0.80 | ±0.10 | ±0.10 | 7.0% | | (XIII) |
| | C1608Y5V224ZFTS | C1608Y5V224ZFT | 1V, 1kHz | 220 | nF | +80%/-20% | 0.80 | ±0.10 | ±0.10 | 9.0% | | (XIV) |
| C1608Y5V334ZFTS | C1608Y5V334ZFT | 1V, 1kHz | 330 | nF | +80%/-20% | 0.80 | ±0.10 | ±0.10 | 9.0% | (I) | | |
| C1608Y5V684ZFTS | C1608Y5V684ZFT | 1V, 1kHz | 680 | nF | +80%/-20% | 0.80 | ±0.15 | ±0.15 | 9.0% | (II) | | |
| C1608Y5V105ZFTS | C1608Y5V105ZFT | 1V, 1kHz | 1.0 | uF | +80%/-20% | 0.80 | ±0.15 | ±0.15 | 10.0% | (III) | | |
| 16V | C1608Y5V103ZETS | C1608Y5V103ZET | 1V, 1kHz | 10 | nF | +80%/-20% | 0.80 | ±0.10 | ±0.10 | 7.0% | Paper, 4Kpcs | (I) |
| | C1608Y5V123ZETS | C1608Y5V123ZET | 1V, 1kHz | 12 | nF | +80%/-20% | 0.80 | ±0.10 | ±0.10 | 7.0% | | (II) |
| | C1608Y5V153ZETS | C1608Y5V153ZET | 1V, 1kHz | 15 | nF | +80%/-20% | 0.80 | ±0.10 | ±0.10 | 7.0% | | (III) |
| | C1608Y5V183ZETS | C1608Y5V183ZET | 1V, 1kHz | 18 | nF | +80%/-20% | 0.80 | ±0.10 | ±0.10 | 7.0% | | (IV) |
| | C1608Y5V223ZETS | C1608Y5V223ZET | 1V, 1kHz | 22 | nF | +80%/-20% | 0.80 | ±0.10 | ±0.10 | 7.0% | | (V) |
| | C1608Y5V273ZETS | C1608Y5V273ZET | 1V, 1kHz | 27 | nF | +80%/-20% | 0.80 | ±0.10 | ±0.10 | 7.0% | | (VI) |
| | C1608Y5V333ZETS | C1608Y5V333ZET | 1V, 1kHz | 33 | nF | +80%/-20% | 0.80 | ±0.10 | ±0.10 | 7.0% | | (VII) |
| | C1608Y5V393ZETS | C1608Y5V393ZET | 1V, 1kHz | 39 | nF | +80%/-20% | 0.80 | ±0.10 | ±0.10 | 7.0% | | (VIII) |
| | C1608Y5V473ZETS | C1608Y5V473ZET | 1V, 1kHz | 47 | nF | +80%/-20% | 0.80 | ±0.10 | ±0.10 | 7.0% | | (IX) |
| | C1608Y5V563ZETS | C1608Y5V563ZET | 1V, 1kHz | 56 | nF | +80%/-20% | 0.80 | ±0.10 | ±0.10 | 7.0% | | (X) |
| | C1608Y5V683ZETS | C1608Y5V683ZET | 1V, 1kHz | 68 | nF | +80%/-20% | 0.80 | ±0.10 | ±0.10 | 7.0% | | (XI) |
| | C1608Y5V823ZETS | C1608Y5V823ZET | 1V, 1kHz | 82 | nF | +80%/-20% | 0.80 | ±0.10 | ±0.10 | 7.0% | | (XII) |
| | C1608Y5V104ZETS | C1608Y5V104ZET | 1V, 1kHz | 100 | nF | +80%/-20% | 0.80 | ±0.10 | ±0.10 | 7.0% | | (XIII) |
| | C1608Y5V224ZETS | C1608Y5V224ZET | 1V, 1kHz | 220 | nF | +80%/-20% | 0.80 | ±0.10 | ±0.10 | 9.0% | | (XIV) |
| C1608Y5V334ZETS | C1608Y5V334ZET | 1V, 1kHz | 330 | nF | +80%/-20% | 0.80 | ±0.10 | ±0.10 | 12.5% | (I) | | |
| C1608Y5V474ZETS | C1608Y5V474ZET | 1V, 1kHz | 470 | nF | +80%/-20% | 0.80 | ±0.10 | ±0.10 | 12.5% | (II) | | |
| C1608Y5V684ZETS | C1608Y5V684ZET | 1V, 1kHz | 680 | nF | +80%/-20% | 0.80 | ±0.10 | ±0.10 | 12.5% | (III) | | |
| C1608Y5V824ZETS | C1608Y5V824ZET | 1V, 1kHz | 820 | nF | +80%/-20% | 0.80 | +0.15/-0.10 | +0.15/-0.10 | 12.5% | (IV) | | |
| C1608Y5V105ZETS | C1608Y5V105ZET | 1V, 1kHz | 1.0 | uF | +80%/-20% | 0.80 | +0.15/-0.10 | +0.15/-0.10 | 12.5% | (V) | | |
| C1608Y5V225ZETS | C1608Y5V225ZET | 1V, 1kHz | 2.2 | uF | +80%/-20% | 0.80 | +0.15/-0.10 | +0.15/-0.10 | 12.5% | (VI) | | |

□ Tolerance Code: M=±20%; Special tolerance on the request.

| RV | DARFON P/N | DARFON P/N 2 | Measuring Condition | Capacitance | | Available Tolerance | Thick. (mm) | Tolerance(mm) | | DF (max.) | Standard Packing | Test Spec. |
|------|-----------------|----------------|---------------------|-------------|------|---------------------|-------------|---------------|-------------|-----------|------------------|------------|
| | | | | Value | Unit | | | L/W | Thick. | | | |
| 10V | C1608Y5V104ZDTS | C1608Y5V104ZDT | 1V, 1kHz | 100 | nF | +80%/-20% | 0.80 | ±0.10 | ±0.10 | 12.5% | Paper, 4Kpcs | (I) |
| | C1608Y5V224ZDTS | C1608Y5V224ZDT | 1V, 1kHz | 220 | nF | +80%/-20% | 0.80 | ±0.10 | ±0.10 | 12.5% | | (II) |
| | C1608Y5V334ZDTS | C1608Y5V334ZDT | 1V, 1kHz | 330 | nF | +80%/-20% | 0.80 | ±0.10 | ±0.10 | 12.5% | | (II) |
| | C1608Y5V474ZDTS | C1608Y5V474ZDT | 1V, 1kHz | 470 | nF | +80%/-20% | 0.80 | ±0.10 | ±0.10 | 12.5% | | (II) |
| | C1608Y5V105ZDTS | C1608Y5V105ZDT | 1V, 1kHz | 1.0 | uF | +80%/-20% | 0.80 | +0.15/-0.10 | +0.15/-0.10 | 12.5% | | (II) |
| | C1608Y5V225ZDTS | C1608Y5V225ZDT | 1V, 1kHz | 2.2 | uF | +80%/-20% | 0.80 | +0.15/-0.10 | +0.15/-0.10 | 12.5% | | (II)* |
| 6.3V | C1608Y5V104ZCTS | C1608Y5V104ZCT | 1V, 1kHz | 100 | nF | +80%/-20% | 0.80 | ±0.10 | ±0.10 | 12.5% | Paper, 4Kpcs | (I) |
| | C1608Y5V224ZCTS | C1608Y5V224ZCT | 1V, 1kHz | 220 | nF | +80%/-20% | 0.80 | ±0.10 | ±0.10 | 12.5% | | (I) |
| | C1608Y5V334ZCTS | C1608Y5V334ZCT | 1V, 1kHz | 330 | nF | +80%/-20% | 0.80 | ±0.10 | ±0.10 | 12.5% | | (I) |
| | C1608Y5V474ZCTS | C1608Y5V474ZCT | 1V, 1kHz | 470 | nF | +80%/-20% | 0.80 | ±0.10 | ±0.10 | 12.5% | | (I) |
| | C1608Y5V105ZCTS | C1608Y5V105ZCT | 1V, 1kHz | 1.0 | uF | +80%/-20% | 0.80 | +0.15/-0.10 | +0.15/-0.10 | 12.5% | | (I) |
| | C1608Y5V225ZCTS | C1608Y5V225ZCT | 1V, 1kHz | 2.2 | uF | +80%/-20% | 0.80 | +0.15/-0.10 | +0.15/-0.10 | 12.5% | | (I) |
| | C1608Y5V475ZCTS | C1608Y5V475ZCT | 1V, 1kHz | 4.7 | uF | +80%/-20% | 0.80 | +0.15/-0.10 | +0.15/-0.10 | 12.5% | | (II) |

● C2012Y5V Series (EIA0805)

| RV | DARFON P/N | DARFON P/N 2 | Measuring Condition | Capacitance | | Available Tolerance | Thick. (mm) | Tolerance(mm) | | DF (max.) | Standard Packing | Test Spec. |
|-----|-----------------|----------------|---------------------|-------------|------|---------------------|-------------|---------------|--------|-----------|------------------|-----------------|
| | | | | Value | Unit | | | L/W | Thick. | | | |
| 50V | C2012Y5V104ZGTS | C2012Y5V104ZGT | 1V, 1kHz | 100 | nF | +80%/-20% | 0.60 | ±0.15/±0.10 | ±0.10 | 5.0% | Paper, 4Kpcs | (I) |
| | C2012Y5V224ZGTS | C2012Y5V224ZGT | 1V, 1kHz | 220 | nF | +80%/-20% | 0.60 | ±0.15/±0.10 | ±0.10 | 5.0% | | (I) |
| | C2012Y5V334ZGTS | C2012Y5V334ZGT | 1V, 1kHz | 330 | nF | +80%/-20% | 0.80 | ±0.15/±0.10 | ±0.10 | 5.0% | | (I) |
| | C2012Y5V474ZGTS | C2012Y5V474ZGT | 1V, 1kHz | 470 | nF | +80%/-20% | 0.80 | ±0.15/±0.10 | ±0.10 | 7.0% | | (I) |
| | C2012Y5V105ZGTS | C2012Y5V105ZGP | 1V, 1kHz | 1.0 | uF | +80%/-20% | 1.25 | ±0.20 | ±0.20 | 9.0% | | Embossed, 3Kpcs |
| 25V | C2012Y5V104ZFTS | C2012Y5V104ZFT | 1V, 1kHz | 100 | nF | +80%/-20% | 0.60 | ±0.15/±0.10 | ±0.10 | 5.0% | Paper, 4Kpcs | (I) |
| | C2012Y5V224ZFTS | C2012Y5V224ZFT | 1V, 1kHz | 220 | nF | +80%/-20% | 0.60 | ±0.15/±0.10 | ±0.10 | 5.0% | | (I) |
| | C2012Y5V474ZFTS | C2012Y5V474ZFT | 1V, 1kHz | 470 | nF | +80%/-20% | 0.80 | ±0.15/±0.10 | ±0.10 | 7.0% | | (I) |
| | C2012Y5V105ZFTS | C2012Y5V105ZFT | 1V, 1kHz | 1.0 | uF | +80%/-20% | 0.85 | ±0.20 | ±0.15 | 9.0% | | (II) |
| | C2012Y5V105ZFPS | C2012Y5V105ZFP | 1V, 1kHz | 1.0 | uF | +80%/-20% | 1.25 | ±0.15/±0.10 | ±0.20 | 7.0% | | (I) |
| | C2012Y5V225ZFPS | C2012Y5V225ZFP | 1V, 1kHz | 2.2 | uF | +80%/-20% | 1.25 | ±0.20 | ±0.20 | 10.0% | | Embossed, 3Kpcs |
| 16V | C2012Y5V104ZETS | C2012Y5V104ZET | 1V, 1kHz | 100 | nF | +80%/-20% | 0.60 | ±0.15/±0.10 | ±0.10 | 5.0% | Paper, 4Kpcs | (I) |
| | C2012Y5V224ZETS | C2012Y5V224ZET | 1V, 1kHz | 220 | nF | +80%/-20% | 0.60 | ±0.15/±0.10 | ±0.10 | 5.0% | | (I) |
| | C2012Y5V474ZETS | C2012Y5V474ZET | 1V, 1kHz | 470 | nF | +80%/-20% | 0.80 | ±0.15/±0.10 | ±0.10 | 7.0% | | (I) |
| | C2012Y5V105ZETS | C2012Y5V105ZET | 1V, 1kHz | 1.0 | uF | +80%/-20% | 0.85 | ±0.20 | ±0.15 | 9.0% | | (I) |
| | C2012Y5V225ZETS | C2012Y5V225ZET | 1V, 1kHz | 2.2 | uF | +80%/-20% | 0.85 | ±0.20 | ±0.15 | 12.5% | | (I) |
| | C2012Y5V475ZEPS | C2012Y5V475ZEP | 1V, 1kHz | 4.7 | uF | +80%/-20% | 1.25 | ±0.15/±0.10 | ±0.10 | 12.5% | | (II) |
| | C2012Y5V106ZEPS | C2012Y5V106ZEP | 1V, 1kHz | 10.0 | uF | +80%/-20% | 1.25 | ±0.20 | ±0.20 | 12.5% | Embossed, 3Kpcs | (II)* |
| 10V | C2012Y5V475ZDPS | C2012Y5V475ZDP | 1V, 1kHz | 4.7 | uF | +80%/-20% | 1.25 | ±0.15/±0.10 | ±0.10 | 12.5% | Embossed, 3Kpcs | (II)* |
| | C2012Y5V106ZDPS | C2012Y5V106ZDP | 1V, 1kHz | 10 | uF | +80%/-20% | 1.25 | ±0.20 | ±0.20 | 12.5% | Embossed, 3Kpcs | (II)* |

● C3216Y5V Series (EIA1206)

| RV | DARFON P/N | DARFON P/N 2 | Measuring Condition | Capacitance | | Available Tolerance | Thick. (mm) | Tolerance(mm) | | DF (max.) | Standard Packing | Test Spec. | |
|-----|------------------|----------------|---------------------|-------------|------|---------------------|-------------|---------------|--------|-----------|------------------|-----------------|------|
| | | | | Value | Unit | | | L/W | Thick. | | | | |
| 50V | C3216Y5V105ZGSPS | C3216Y5V105ZGP | 1V, 1kHz | 1.0 | uF | +80%/-20% | 0.95 | ±0.15/±0.20 | ±0.15 | 7.0% | Embossed, 3Kpcs | (I) | |
| | C3216Y5V475ZGSPS | C3216Y5V475ZGP | 1V, 1kHz | 4.7 | uF | +80%/-20% | 1.60 | ±0.30 | ±0.30 | 9.0% | Embossed, 2Kpcs | (I) | |
| 35V | C3216Y5V475ZNPS | C3216Y5V475ZNP | 1V, 1kHz | 4.7 | uF | +80%/-20% | 1.15 | ±0.20 | ±0.15 | 12.5% | Embossed, 3Kpcs | (II)* | |
| 25V | C3216Y5V225ZFPS | C3216Y5V225ZFP | 1V, 1kHz | 2.2 | uF | +80%/-20% | 0.95 | ±0.15/±0.20 | ±0.15 | 9.0% | Embossed, 3Kpcs | (I) | |
| | C3216Y5V475ZFPS | C3216Y5V475ZFP | 1V, 1kHz | 4.7 | uF | +80%/-20% | 1.15 | ±0.20 | ±0.15 | 9.0% | | (I) | |
| | C3216Y5V106ZFPS | C3216Y5V106ZFP | 1V, 1kHz | 10 | uF | +80%/-20% | 1.60 | ±0.30 | ±0.30 | 12.5% | | Embossed, 2Kpcs | (II) |
| 16V | C3216Y5V475ZETS | C3216Y5V475ZET | 1V, 1kHz | 4.7 | uF | +80%/-20% | 0.85 | ±0.30/±0.20 | ±0.10 | 12.5% | Paper, 4Kpcs | (II) | |
| | C3216Y5V475ZEPS | C3216Y5V475ZEP | 1V, 1kHz | 4.7 | uF | +80%/-20% | 1.15 | ±0.20 | ±0.15 | 12.5% | | (I) | |
| | C3216Y5V106ZEPS | C3216Y5V106ZEP | 1V, 1kHz | 10 | uF | +80%/-20% | 1.15 | ±0.20 | ±0.20 | 12.5% | | Embossed, 3Kpcs | (I) |
| | C3216Y5V226ZEPS | C3216Y5V226ZEP | 0.5V, 120Hz | 22 | uF | +80%/-20% | 1.60 | ±0.30 | ±0.30 | 12.5% | | Embossed, 2Kpcs | (I) |
| 10V | C3216Y5V475ZDPS | C3216Y5V475ZDP | 1V, 1kHz | 4.7 | uF | +80%/-20% | 1.15 | ±0.20 | ±0.15 | 12.5% | Embossed, 3Kpcs | (I) | |
| | C3216Y5V226ZDPS | C3216Y5V226ZDP | 0.5V, 120Hz | 22 | uF | +80%/-20% | 1.60 | ±0.30 | ±0.30 | 20.0% | Embossed, 2Kpcs | (II) | |

● C3225Y5V Series (EIA1210)

| RV | DARFON P/N | DARFON P/N 2 | Measuring Condition | Capacitance | | Available Tolerance | Thick. (mm) | Tolerance(mm) | | DF (max.) | Standard Packing | Test Spec. |
|------|-----------------|----------------|---------------------|-------------|------|---------------------|-------------|---------------|--------|-----------|------------------|------------|
| | | | | Value | Unit | | | L/W | Thick. | | | |
| 35V | C3225Y5V106ZNPS | C3225Y5V106ZNP | 1V, 1kHz | 10 | uF | +80%/-20% | 1.60 | ±0.20 | ±0.20 | 9.0% | Embossed, 2Kpcs | (I) |
| 6.3V | C3225Y5V476ZCWS | C3225Y5V476ZCW | 0.5V, 120Hz | 47 | uF | +80%/-20% | 2.00 | ±0.40/±0.30 | ±0.20 | 20.0% | Embossed, 1Kpcs | (II) |

(II)* High temperature load life test are applicable in rated voltage *100%

- Test Spec.
- General Purpose (I)

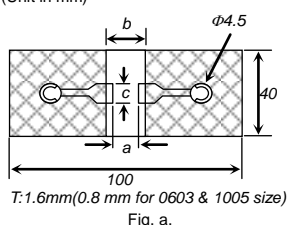
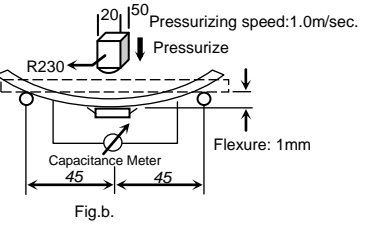
| Item | Specification | | Test Method | | | | | | | | | | | | | | | | | | | | | | | | | | | | | | | | |
|-------------|---|---|--|---|---|---|------|-----|-----|-----|------|-----|-----|-----|------|-----|-----|-----|------|-----|-----|------|------|-----|-----|-----|------|-----|-----|-----|------|-----|-----|-----|---|
| | Temp. compensation type | High dielectric constant type | | | | | | | | | | | | | | | | | | | | | | | | | | | | | | | | | |
| 1 | Operation Temperature Range | NP0: -55 to 125 °C X5R: -55 to 85 °C X6S: -55 to 105 °C X7R/X7S/X7T/X7U : -55 to 125 °C Y5V: -30 to 85 °C | --- | | | | | | | | | | | | | | | | | | | | | | | | | | | | | | | | |
| 2 | Rated Voltage | Shown in the table of "Part Number & Characteristic" | The rated voltage is defined as the maximum voltage, which may be applied continuously to the capacitor. | | | | | | | | | | | | | | | | | | | | | | | | | | | | | | | | |
| 3 | Appearance | No defects or abnormalities. | Visual inspection | | | | | | | | | | | | | | | | | | | | | | | | | | | | | | | | |
| 4 | Dimensions | Within the specified dimension. | Using calipers | | | | | | | | | | | | | | | | | | | | | | | | | | | | | | | | |
| 5 | Dielectric Strength | No defects or abnormalities. | No failure shall be observed when 250% of the rated voltage is applied between the terminations for 1 to 5 seconds. The charge and discharge current is less than 50mA. | | | | | | | | | | | | | | | | | | | | | | | | | | | | | | | | |
| 6 | Insulation Resistance (I.R.) | To apply rated voltage. I.R. $\geq 10G\Omega$ or $R_C R \geq 500\Omega \cdot F$ (whichever is smaller) | The insulation resistance shall be measured with a DC voltage not exceeding the rated voltage at 25°C and 75%RH max, and within 1 minute of charging. | | | | | | | | | | | | | | | | | | | | | | | | | | | | | | | | |
| 7 | Capacitance | Within the specified tolerance * X5R, X6S, X7RS, X7S, X7T, X7U and Y5V at 1000 hours | The capacitance / D.F. shall be measured at 25°C at the frequency and voltage shown in the table of "Part Number & Characteristic". | | | | | | | | | | | | | | | | | | | | | | | | | | | | | | | | |
| 8 | Q/Dissipation Factor (D.F.) | NP0: If $C \leq 30pF$, $DF \leq 1/(400+20C)$, C in pF If $C > 30pF$, $DF \leq 0.1\%$. | Shown in the table of "Part Number & Characteristic" | | | | | | | | | | | | | | | | | | | | | | | | | | | | | | | | |
| 9 | Capacitance Temperature Characteristics | Capacitance change NP0 within $0 \pm 30ppm/^\circ C$ under operating temperature range. X5R/X7R within $\pm 15\%$ X6S/X7S within $\pm 22\%$ X7T: -33% to + 22% X7U: -56% to + 22% Y5V: -82 to + 22% | 1. Temperature compensation type: The capacitance value at 25°C and 85°C shall be measured and calculated from the formula given below. $T.C. = (C_{85} - C_{25}) / C_{25} \cdot \Delta T \cdot 10^6 (PPM/^\circ C)$ 2. High dielectric constant type: The ranges of capacitance change compared with the 25°C value over the temperature ranges shall be within the specified ranges. | | | | | | | | | | | | | | | | | | | | | | | | | | | | | | | | |
| 10 | Termination Strength | No removal of the terminations or marking defect. | Apply a parallel force of 5N to a PCB mounted sample for 10 ± 1 sec. *2N for 0603 (EIA 0201). | | | | | | | | | | | | | | | | | | | | | | | | | | | | | | | | |
| 11 | Deflection (Bending Strength) | No cracking or marking defects shall occur at 1mm deflection. Capacitance change: NP0: within $\pm 5\%$ or $\pm 0.5pF$. (whichever is larger) X5R, X6S, X7R, X7S, X7T, X7U: within $\pm 12.5\%$ Y5V: within $\pm 20\%$ | Solder the capacitor to the test jig (glass epoxy boards) shown in Fig.a using a SAC305(Sn96.5Ag3.0Cu0.5) solder (then let sit for 24 ± 2 hours for X5R, X6S, X7R, X7S, X7T, X7U and Y5V). Then apply a force in the direction shown in Fig.b. The soldering shall be done with the reflow method and shall be conducted with care so that the soldering is uniform and free of defects such as heat shock. | | | | | | | | | | | | | | | | | | | | | | | | | | | | | | | | |
| | | (Unit in mm)  <table border="1" data-bbox="774 1400 981 1590"> <thead> <tr> <th>Size</th> <th>a</th> <th>b</th> <th>C</th> </tr> </thead> <tbody> <tr> <td>0603</td> <td>0.3</td> <td>0.9</td> <td>0.3</td> </tr> <tr> <td>1005</td> <td>0.4</td> <td>1.5</td> <td>0.5</td> </tr> <tr> <td>1608</td> <td>1.0</td> <td>3.0</td> <td>1.2</td> </tr> <tr> <td>2012</td> <td>1.2</td> <td>4.0</td> <td>1.65</td> </tr> <tr> <td>3216</td> <td>2.2</td> <td>5.0</td> <td>2.0</td> </tr> <tr> <td>4520</td> <td>3.5</td> <td>7.0</td> <td>2.5</td> </tr> <tr> <td>4532</td> <td>3.5</td> <td>7.0</td> <td>3.7</td> </tr> </tbody> </table> T: 1.6mm (0.8 mm for 0603 & 1005 size) Fig. a. | Size | a | b | C | 0603 | 0.3 | 0.9 | 0.3 | 1005 | 0.4 | 1.5 | 0.5 | 1608 | 1.0 | 3.0 | 1.2 | 2012 | 1.2 | 4.0 | 1.65 | 3216 | 2.2 | 5.0 | 2.0 | 4520 | 3.5 | 7.0 | 2.5 | 4532 | 3.5 | 7.0 | 3.7 |  Fig. b. |
| Size | a | b | C | | | | | | | | | | | | | | | | | | | | | | | | | | | | | | | | |
| 0603 | 0.3 | 0.9 | 0.3 | | | | | | | | | | | | | | | | | | | | | | | | | | | | | | | | |
| 1005 | 0.4 | 1.5 | 0.5 | | | | | | | | | | | | | | | | | | | | | | | | | | | | | | | | |
| 1608 | 1.0 | 3.0 | 1.2 | | | | | | | | | | | | | | | | | | | | | | | | | | | | | | | | |
| 2012 | 1.2 | 4.0 | 1.65 | | | | | | | | | | | | | | | | | | | | | | | | | | | | | | | | |
| 3216 | 2.2 | 5.0 | 2.0 | | | | | | | | | | | | | | | | | | | | | | | | | | | | | | | | |
| 4520 | 3.5 | 7.0 | 2.5 | | | | | | | | | | | | | | | | | | | | | | | | | | | | | | | | |
| 4532 | 3.5 | 7.0 | 3.7 | | | | | | | | | | | | | | | | | | | | | | | | | | | | | | | | |
| 12 | Solderability of Termination | 90% of the terminations are to be soldered evenly and continuously. | Immerse the test capacitor into a methanol solution containing rosin for 3 to 5 seconds, preheat it 150 to 180°C for 2 to 3 minutes and immerse it into SAC305(Sn96.5Ag3.0Cu0.5) solder of $245 \pm 5^\circ C$ for 3 ± 1 seconds. | | | | | | | | | | | | | | | | | | | | | | | | | | | | | | | | |
| 13 | Resistance to Soldering Heat | Appearance | No marking defects | | | | | | | | | | | | | | | | | | | | | | | | | | | | | | | | |
| Cap. Change | | NP0 within $\pm 2.5\%$ or $0.25pF$ (whichever is larger) X5R/X6S/X7R/X7S/X7T/X7U within $\pm 7.5\%$ Y5V within $\pm 20\%$ | *Preheat the capacitor at 120 to 150°C for 1 minute. Immerse the capacitor in a SAC305(Sn96.5Ag3.0Cu0.5) solder solution at $270 \pm 5^\circ C$ for 10 ± 1 seconds. Let sit at room temperature for 24 ± 2 hours, then measure. | | | | | | | | | | | | | | | | | | | | | | | | | | | | | | | | |
| Q/D.F. | | If $C \leq 30pF$, $DF \leq 1/(400+20C)$ If $C > 30pF$, $DF \leq 0.1\%$ | To satisfy the specified initial spec. | * Preheat 150 to 200°C for size ≥ 3216 . | | | | | | | | | | | | | | | | | | | | | | | | | | | | | | | |
| I.R. | | I.R. $\geq 10,000M\Omega$ or $R_C R \geq 500\Omega \cdot F$. (whichever is smaller) | I.R. $\geq 10,000M\Omega$ or $R_C R \geq 500\Omega \cdot F$. (whichever is smaller) | *High dielectric constant type: Initial measurement : perform a heat treatment at $150 \pm 0/-10^\circ C$ for one hour and then let sit for 24 ± 2 hours at room temperature. Perform the initial measurement. | | | | | | | | | | | | | | | | | | | | | | | | | | | | | | | |

| | Item | Specification | | Test Method | |
|----|--------------------------------------|-------------------------|---|--|--|
| | | Temp. compensation type | High dielectric constant type | | |
| 14 | Temperature cycle (Thermal shock) | Appearance | No marking defects | | Solder the capacitor to supporting jig (Glass epoxy board) and perform the five cycles according to the four heat treatments listed in the following table. Let sit for 24±2hrs at room temperature, then measure. Step 1: Minimum operating temperature 30±3min Step 2: Room temperature 2~3 min Step 3: Maximum operating temperature 30±3min Step 4: Room temperature 2~3min *High dielectric constant type: Initial measurement: perform a heat treatment at 150±10°C for one hour and then let sit for 24±2 hours at room temp. Perform the initial measurement. |
| | | Cap. Change | NPO within ±2.5% or 0.25pF (whichever is larger) | X5R/X6S/X7R/X7S/X7T within ±7.5% X7U within ±30% Y5V within ±20% | |
| | | Q/D.F. | If C ≤ 30pF, DF ≤ 1/(400+20C) If C > 30pF, DF ≤ 0.1% | To satisfy the specified initial spec. | |
| | | I.R. | I.R. ≥ 10GΩ or R _C R ≥ 500Ω-F. (whichever is smaller) | I.R. ≥ 10GΩ or R _C R ≥ 500Ω-F. (whichever is smaller) | |
| 15 | Humidity load | Appearance | No marking defects | | Apply the rated voltage at 40±2°C and 90 to 95% humidity for 500±12 hours. The charge / discharge current is less than 50mA. [Temperature compensation type] Remove and let sit for 24±2 hours at room temperature, then measure. [High dielectric constant type] *Initial measurement Perform a heat treatment at 150+0/-10°C for one hour and then let sit for 24±2 hours at room temperature. Perform the initial measurement. *Measurement after test Perform a heat treatment and then let sit for 24±2 hours at room temperature, then measure. |
| | | Cap. Change | NPO within ±7.5% or 0.75pF (whichever is larger) | X5R/X6S/X7R/X7S/X7T/X7U within ±12.5% Y5V within ±30% | |
| | | Q/D.F. | If C > 30pF, DF ≤ 0.5% If C ≤ 30pF, DF ≤ 1/(100+10xC/3) C in pF | X5R/X6S/X7R/X7S/X7T/X7U 200% max of initial spec. Y5V 150% max of initial spec. | |
| | | I.R. | I.R. ≥ 500MΩ or R _C R ≥ 25Ω-F. (whichever is smaller) | I.R. ≥ 500MΩ or R _C R ≥ 25Ω-F. (whichever is smaller) | |
| 16 | High temperature load life test | Appearance | No marking defects | | Apply 200% of the rated voltage for 1000±12 hours at the maximum operating temperature ± 3°C. The charge / discharge current is less than 50mA. [Temperature compensation type] Remove and let sit for 24±2 hours at room temperature, then measure. [High dielectric constant type] *Initial measurement Perform a heat treatment at 150+0/-10°C for one hour and then let sit for 24±2 hours at room temperature. Perform the initial measurement. *Measurement after test Perform a heat treatment and then let sit for 24±2 hours at room temperature, then measure. |
| | | Cap. Change | NPO within ±7.5% or 0.75pF (whichever is larger) | X5R/X6S/X7R/X7S/X7T/X7U within ±12.5% Y5V within ±30% | |
| | | Q/D.F. | If C > 30pF, DF ≤ 0.3% If 10pF < C ≤ 30pF, DF ≤ 1/(275+5xC/2) If C ≤ 10pF, DF ≤ 1/(200+10C), C in pF | X5R/X6S/X7R/X7S/X7T/X7U 200% max of initial spec. Y5V 150% max of initial spec. | |
| | | I.R. | More than 1GΩ or R _C R ≥ 50Ω-F (whichever is less.) | More than 1GΩ or R _C R ≥ 50Ω-F (whichever is less.) | |

● General Purpose (II)

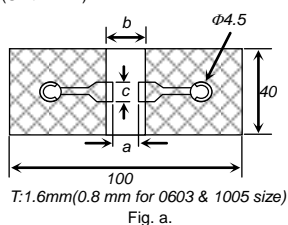
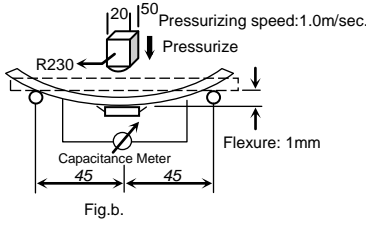
| Item | Specification | Test Method | | | | | | | | | | | | | | | | | | | | | | | | | | | | | | | | |
|------|--|--|------|---|---|------|-----|-----|-----|------|-----|-----|-----|------|-----|-----|-----|------|-----|-----|------|------|-----|-----|-----|------|-----|-----|-----|------|-----|-----|-----|--|
| 1 | Operation Temperature Range X5R: -55 to 85 °C X6S: -55 to 105 °C X7R/X7S/X7T/X7U: -55 to 125 °C Y5V: -30 to 85 °C | --- | | | | | | | | | | | | | | | | | | | | | | | | | | | | | | | | |
| 2 | Rated Voltage | Shown in the table of "Part Number & Characteristic" | | | | | | | | | | | | | | | | | | | | | | | | | | | | | | | | |
| 3 | Appearance | No defects or abnormalities. | | | | | | | | | | | | | | | | | | | | | | | | | | | | | | | | |
| 4 | Dimensions | Within the specified dimension. | | | | | | | | | | | | | | | | | | | | | | | | | | | | | | | | |
| 5 | Dielectric Strength | No defects or abnormalities. | | | | | | | | | | | | | | | | | | | | | | | | | | | | | | | | |
| 6 | Insulation Resistance (I.R.) | No failure shall be observed when 250% of the rated voltage is applied between the terminations for 1 to 5 seconds. The charge and discharge current is less than 50mA. | | | | | | | | | | | | | | | | | | | | | | | | | | | | | | | | |
| 7 | Capacitance | The insulation resistance shall be measured with a DC voltage not exceeding the rated voltage at 25°C and 75%RH max, and within 1 minute of charging, provided the charge/discharge current is less than 50 mA. | | | | | | | | | | | | | | | | | | | | | | | | | | | | | | | | |
| 8 | Q/Dissipation Factor (D.F.) | The capacitance / D.F. shall be measured at 25°C at the frequency and voltage shown in the table of "Part Number & Characteristic". | | | | | | | | | | | | | | | | | | | | | | | | | | | | | | | | |
| 9 | Capacitance Temperature Characteristics | Shown in the table of "Part Number & Characteristic" | | | | | | | | | | | | | | | | | | | | | | | | | | | | | | | | |
| 10 | Termination Strength | Capacitance change X5R/X7R within ±15% , X6S/X7S within ±22% X7U: -56% to + 22% X7T: -33% to + 22% Y5V: -82% to + 22% | | | | | | | | | | | | | | | | | | | | | | | | | | | | | | | | |
| 11 | Deflection (Bending Strength) | No removal of the terminations or marking defect. Apply a parallel force of 5N to a PCB mounted sample for 10±1sec. *2N for 0603 (EIA 0201). | | | | | | | | | | | | | | | | | | | | | | | | | | | | | | | | |
| 12 | Solderability of Termination | No cracking or marking defects shall occur at 1mm deflection. Capacitance change: X5R, X6S, X7R, X7S, X7T, X7U :within ±12.5% Y5V: within±20% | | | | | | | | | | | | | | | | | | | | | | | | | | | | | | | | |
| 13 | Resistance to Soldering Heat | Solder the capacitor to the test jig (glass epoxy boards) shown in Fig.a using a SAC305(Sn96.5Ag3.0Cu0.5) solder (then let sit for 24±2 hours for X5R, X6S, X7R, X7S, X7T, X7U and Y5V). Then apply a force in the direction shown in Fig.b. The soldering shall be done with the reflow method and shall be conducted with care so that the soldering is uniform and free of defects such as heat shock. | | | | | | | | | | | | | | | | | | | | | | | | | | | | | | | | |
| | (Unit in mm)  <table border="1" data-bbox="774 1176 981 1355"> <thead> <tr> <th>Size</th> <th>a</th> <th>b</th> <th>C</th> </tr> </thead> <tbody> <tr> <td>0603</td> <td>0.3</td> <td>0.9</td> <td>0.3</td> </tr> <tr> <td>1005</td> <td>0.4</td> <td>1.5</td> <td>0.5</td> </tr> <tr> <td>1608</td> <td>1.0</td> <td>3.0</td> <td>1.2</td> </tr> <tr> <td>2012</td> <td>1.2</td> <td>4.0</td> <td>1.65</td> </tr> <tr> <td>3216</td> <td>2.2</td> <td>5.0</td> <td>2.0</td> </tr> <tr> <td>4520</td> <td>3.5</td> <td>7.0</td> <td>2.5</td> </tr> <tr> <td>4532</td> <td>3.5</td> <td>7.0</td> <td>3.7</td> </tr> </tbody> </table>  | Size | a | b | C | 0603 | 0.3 | 0.9 | 0.3 | 1005 | 0.4 | 1.5 | 0.5 | 1608 | 1.0 | 3.0 | 1.2 | 2012 | 1.2 | 4.0 | 1.65 | 3216 | 2.2 | 5.0 | 2.0 | 4520 | 3.5 | 7.0 | 2.5 | 4532 | 3.5 | 7.0 | 3.7 | |
| Size | a | b | C | | | | | | | | | | | | | | | | | | | | | | | | | | | | | | | |
| 0603 | 0.3 | 0.9 | 0.3 | | | | | | | | | | | | | | | | | | | | | | | | | | | | | | | |
| 1005 | 0.4 | 1.5 | 0.5 | | | | | | | | | | | | | | | | | | | | | | | | | | | | | | | |
| 1608 | 1.0 | 3.0 | 1.2 | | | | | | | | | | | | | | | | | | | | | | | | | | | | | | | |
| 2012 | 1.2 | 4.0 | 1.65 | | | | | | | | | | | | | | | | | | | | | | | | | | | | | | | |
| 3216 | 2.2 | 5.0 | 2.0 | | | | | | | | | | | | | | | | | | | | | | | | | | | | | | | |
| 4520 | 3.5 | 7.0 | 2.5 | | | | | | | | | | | | | | | | | | | | | | | | | | | | | | | |
| 4532 | 3.5 | 7.0 | 3.7 | | | | | | | | | | | | | | | | | | | | | | | | | | | | | | | |
| | Appearance | 90% of the terminations are to be soldered evenly and continuously. | | | | | | | | | | | | | | | | | | | | | | | | | | | | | | | | |
| | Cap. Change | Immerse the test capacitor into a methanol solution containing rosin for 3 to 5 seconds, preheat it 150 to 180°C for 2 to 3 minutes and immerse it into SAC305(Sn96.5Ag3.0Cu0.5) solder of 245 ± 5°C for 3±1seconds. | | | | | | | | | | | | | | | | | | | | | | | | | | | | | | | | |
| | D.F. | *Preheat the capacitor at 120 to 150°C for 1 minute. | | | | | | | | | | | | | | | | | | | | | | | | | | | | | | | | |
| | I.R. | Immerse the capacitor in a SAC305(Sn96.5Ag3.0Cu0.5) solder solution at 270±5°C for 10±1 seconds. Let sit at room temperature for 24±2 hours, then measure. * Preheat 150 to 200°C for size ≥3216. * Initial measurement : perform a heat treatment at 150+0/-10°C for one hour and then let sit for 24±2 hours at room temperature. Perform the initial measurement. | | | | | | | | | | | | | | | | | | | | | | | | | | | | | | | | |

| Item | | Specification | Test Method |
|------|--------------------------------------|---------------|---|
| 14 | Temperature cycle (Thermal shock) | Appearance | Solder the capacitor to supporting jig (Glass epoxy board) and perform the five cycles according to the four heat treatments listed in the following table. Let sit for 24±2hrs at room temperature, then measure. Step 1: Minimum operating temperature 30±3min Step 2: Room temperature 2-3 min Step 3: Maximum operating temperature 30±3min Step 4: Room temperature 2-3min * Initial measurement: perform a heat treatment at 150±10°C for one hour and then let sit for 24±2 hours at room temp. Perform the initial measurement. |
| | | Cap. Change | |
| | | Q/D.F. | |
| | | I.R. | |
| 15 | Humidity load | Appearance | Apply the rated voltage at 40±2°C and 90 to 95% humidity for 500±12 hours. The charge / discharge current is less than 50mA. *Initial measurement Perform a heat treatment at 150+0/-10°C for one hour and then let sit for 24±2 hours at room temperature. Perform the initial measurement. *Measurement after test Perform a heat treatment and then let sit for 24±2 hours at room temperature, then measure. |
| | | Cap. Change | |
| | | Q/D.F. | |
| | | I.R. | |
| 16 | High temperature load life test | Appearance | Apply 150% of the rated voltage for 1000±12 hours at the maximum operating temperature ± 3°C. The charge / discharge current is less than 50mA. *Initial measurement Perform a heat treatment at 150+0/-10°C for one hour and then let sit for 24±2 hours at room temperature. Perform the initial measurement. *Measurement after test Perform a heat treatment and then let sit for 24±2 hours at room temperature, then measure. * Some of the parts are applicable in rated voltage *100%. Please refer to "Part Number & Characteristic" with (II)* labeled in "Test Spec." |
| | | Cap. Change | |
| | | D.F. | |
| | | I.R. | |

Package

- Tape and reel packaging**

Tape and reel packaging is currently the most promising system for high-speed production. A typical 180mm (7 inch) diameter reel contains 1,500 to 15,000 capacitors, 250mm (10 inch) contains 10,000 capacitors, and 330mm (13 inch) contains 10,000 to 50,000 capacitors. Three standard sizes are available in taped and reeled package either with paper carrier tapes or embossed tapes.

【Paper tape specifications】



| SYMBOL | PRODUCT SIZE CODE | | | | | | | | | | UNIT |
|--------|-------------------|--------|----------------------|--------|-------------------------|--------|-------------------------|--------|-------------------------|--------|------|
| | C0603(0201) | | C1005(0402) Standard | | C1005(0402) Special (1) | | C1005(0402) Special (2) | | C1005(0402) Special (3) | | |
| | SIZE | TOL. | SIZE | TOL. | SIZE | TOL. | SIZE | TOL. | SIZE | TOL. | |
| A | 0.38 | ± 0.04 | 0.65 | ± 0.10 | 0.70 | ± 0.10 | 0.72 | ± 0.10 | 0.80 | ± 0.10 | mm |
| B | 0.68 | ± 0.04 | 1.15 | ± 0.10 | 1.19 | ± 0.10 | 1.25 | ± 0.10 | 1.35 | ± 0.10 | mm |
| F | 3.5 | ± 0.05 | 3.5 | ± 0.05 | 3.5 | ± 0.05 | 3.5 | ± 0.05 | 3.5 | ± 0.05 | mm |
| P | 2 | ± 0.10 | 2 | ± 0.10 | 2 | ± 0.10 | 2 | ± 0.10 | 2 | ± 0.10 | mm |
| W | 8 | ± 0.20 | 8 | ± 0.20 | 8 | ± 0.20 | 8 | ± 0.20 | 8 | ± 0.20 | mm |

| SYMBOL | PRODUCT SIZE CODE (EIA) | | | | | | | | | | UNIT |
|--------|-------------------------|-------|--------------------------|-------|----------------------------|-------|--------------|-------|--------------|-------|------|
| | C1608(0603) Standard | | C1608 (0603) Special (1) | | C1608 (0603) Special (2/3) | | C2012 (0805) | | C3216 (1206) | | |
| | SIZE | TOL. | SIZE | TOL. | SIZE | TOL. | SIZE | TOL. | SIZE | TOL. | |
| A | 1.0 | ±0.2 | 1.0 | ±0.2 | 1.1 | ±0.2 | 1.5 | ±0.2 | 1.9 | ±0.2 | mm |
| B | 1.8 | ±0.2 | 1.8 | ±0.2 | 1.9 | ±0.2 | 2.3 | ±0.2 | 3.6 | ±0.2 | mm |
| F | 3.5 | ±0.05 | 3.5 | ±0.05 | 3.5 | ±0.05 | 3.5 | ±0.05 | 3.5 | ±0.05 | mm |
| P | 4 | ±0.1 | 4 | ±0.1 | 4 | ±0.1 | 4 | ±0.1 | 4 | ±0.1 | mm |
| W | 8 | ±0.2 | 8 | ±0.2 | 8 | ±0.2 | 8 | ±0.2 | 8 | ±0.2 | mm |

【 Embossed tape specifications 】

1mm and 4mm and 8mm pitch tape

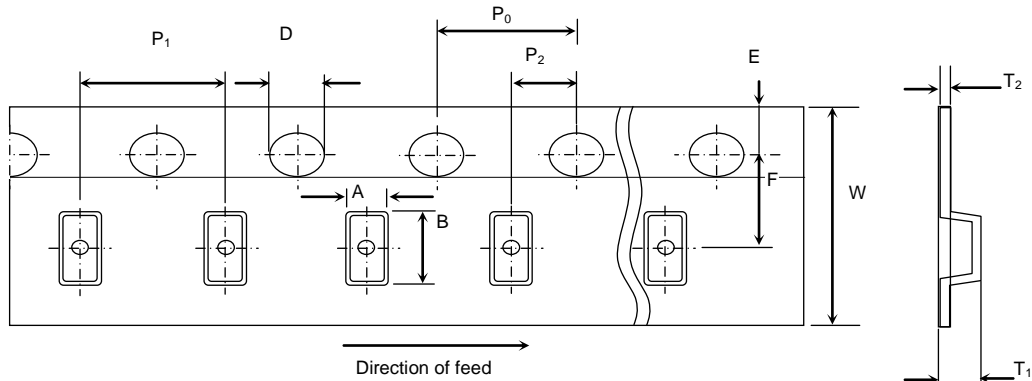

For $W=8\text{mm}$: $T_1=2.5\text{mm max.}$

For $W=12\text{mm}$: $T_1=4.5\text{mm}$

| DIMENSION (mm) | PRODUCT SIZE CODE | | | | | |
|-------------------|--------------------|--------------------|--------------------|--------------------|--------------------|--------------------|
| | 4 mm tape | | | | 8 mm tape | |
| | 1608 (0603) | 2012 (0805) | 3216 (1206) | 3225 (1210) | 4520 (1808) | 4532 (1812) |
| P_1 | 4 ± 0.1 | 4 ± 0.1 | 4 ± 0.1 | 4 ± 0.1 | 8 ± 0.1 | 8 ± 0.1 |
| P_0 | 4 ± 0.1 | 4 ± 0.1 | 4 ± 0.1 | 4 ± 0.1 | 4 ± 0.1 | 4 ± 0.1 |
| P_2 | 2 ± 0.05 | 2 ± 0.05 | 2 ± 0.05 | 2 ± 0.05 | 2 ± 0.05 | 2 ± 0.05 |
| A | 1.2 ± 0.2 | 1.45 ± 0.2 | 1.9 ± 0.2 | 2.8 ± 0.2 | 2.3 ± 0.2 | 3.6 ± 0.2 |
| B | 2.0 ± 0.2 | 2.3 ± 0.2 | 3.5 ± 0.2 | 3.6 ± 0.2 | 4.9 ± 0.2 | 4.9 ± 0.2 |
| W | 8 ± 0.3 | 8 ± 0.2 | 8 ± 0.2 | 8 ± 0.2 | 12 ± 0.2 | 12 ± 0.2 |
| E | 1.75 ± 0.1 | 1.75 ± 0.1 | 1.75 ± 0.1 | 1.75 ± 0.1 | 1.75 ± 0.1 | 1.75 ± 0.1 |
| F | 3.5 ± 0.05 | 3.5 ± 0.05 | 3.5 ± 0.05 | 3.5 ± 0.05 | 5.5 ± 0.05 | 5.5 ± 0.05 |
| D | 1.5 (+0.1/-0.0) | 1.5 (+0.1/-0.0) | 1.5 (+0.1/-0.0) | 1.5 (+0.1/-0.0) | 1.5 (+0.1/-0.0) | 1.5 (+0.1/-0.0) |
| T_1 | 1.4 max. | 2.5 max. | 2.5 max. | 2.5 max. | 4.5 | 4.5 |
| T_2 | 0.25 ± 0.1 | 0.305 ± 0.1 | 0.30 ± 0.1 | 0.30 ± 0.1 | 0.30 ± 0.1 | 0.30 ± 0.1 |

【Reel specifications】

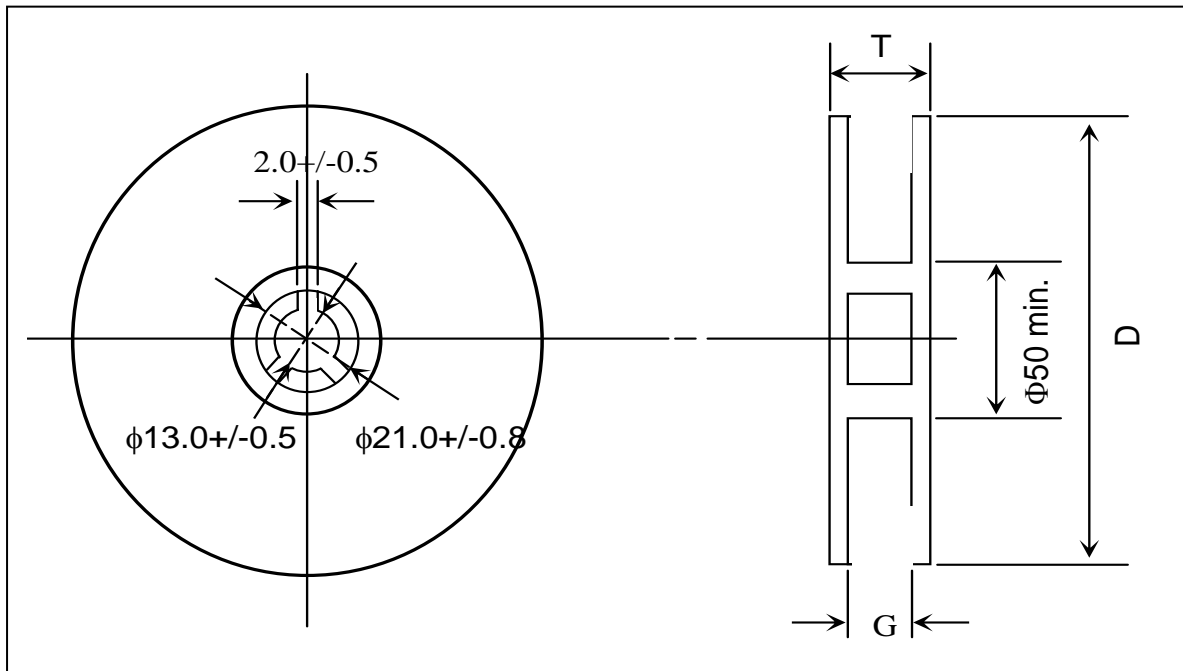

| TAPE WIDTH (mm) | G (mm) | T max. (mm) | D (mm) |
|-----------------|----------------|-------------|--------|
| 4 | 5.0 ± 1.5 | 8.0 | 180 |
| 8 | 10.0 ± 1.5 | 14.5 | 180 |
| 8 | 10.0 ± 1.5 | 14.5 | 250 |
| 8 | 10.0 ± 1.5 | 14.5 | 330 |
| 12 | 14.0 ± 1.5 | 18.5 | 180 |

MLCC

【Thickness and Packing Amount】

| Thickness | | | Amount per reel | | | |
|-----------|-----------|--------------|-----------------|-------------------|--------------|----------|
| Code | Spec.(mm) | Size (EIA) | 180 mm (7") | | 330 mm (13") | |
| | | | Paper | Embossed | Paper | Embossed |
| Z | 0.20 | 0402 (01005) | 20K | 40K ^{#1} | | |
| A | 0.30 | 0603 (0201) | 15K | | 50K | |
| | | 1005 (0402) | 15K | | 50K | |
| B | 0.50 | 1005 (0402) | 10K | | 50K | |
| Q | 0.45 | 1005 (0402) | 10K | | 50K | |
| | | 1608 (0603) | 4K | | 15K | |
| C | 0.60 | 2012 (0805) | 4K | | 15K | |
| | | 3216 (1206) | 4K | | 15K | |
| D | 0.80 | 1608 (0603) | 4K | 4K | 15K | |
| E | 0.85 | 2012 (0805) | 4K | | 15K | |
| | | 3216 (1206) | 4K | | 15K | |
| | | 3225 (1210) | | 3K | | 10K |
| I | 0.95 | 4532 (1812) | | 1K | | |
| | | 2012 (0805) | | 3K | | |
| F | 1.15 | 3216 (1206) | | 3K | | |
| | | 4520 (1808) | | 3K | | 10K |
| G | 1.25 | 3216 (1206) | | 3K | | 10K |
| | | 2012 (0805) | | 2K/3K | | 10K |
| | | 3216 (1206) | | 3K | | 10K |
| | | 3225 (1210) | | 3K | | |
| | | 4520 (1808) | | 2K/3K | | |
| | | 4532 (1812) | | 1K | | |
| L | 1.60 | 3225 (1210) | | 3K | | |
| | | 3216 (1206) | | 2K | | |
| | | 4520 (1808) | | 2K | | |
| | | 4532 (1812) | | 1K | | |
| N | 2.00 | 3216 (1206) | | 2K/3K | | |
| | | 3225 (1210) | | 1K/2K | | |
| | | 4520 (1808) | | 1K | | |
| | | 4532 (1812) | | 1K | | |
| P | 2.50 | 3225 (1210) | | 500pcs/1K | | |

#1: 4mm width 1mm pitch Embossed Taping

【Packing Rule】

| EIA SIZE | Tape | Reel Size | Reels/Box | Boxes/ Carton |
|----------|--------------|-----------|-----------|---------------|
| 01005 | Emboss | 7" | 8 | 12 |
| 01005 | Paper | 7" | 5 | 12 |
| 0201 | Paper | 7" | 5 | 12 |
| 0402 | Paper | 7" | 5 | 12 |
| 0603 | Paper/Emboss | 7" | 5 | 12 |
| 0805 | Paper/Emboss | 7" | 5 | 12 |
| 1206 | Paper/Emboss | 7" | 5 | 12 |
| 1210 | Emboss | 7" | 5 | 12 |
| 1808 | Emboss | 7" | 5 | 12 |
| 1812 | Emboss | 7" | 5 | 12 |

Others

【Storage】

1. The chip capacitors shall be packaged in carrier tapes or bulk cases.
2. Keep storage place temperatures from +5°C to +35°C, humidity from 45 to 70% RH.
3. The storage atmosphere must be free of gas containing sulfur and chlorine. Also, avoid exposing the product to saline moisture. If the product is exposed to such atmospheres, the terminations will oxidize and solderability will be affected.
4. The solderability is assured for 12 months from our final inspection date if the above storage condition is followed.

【Circuit Design】

1. Once application and assembly environments have been checked, the capacitor may be used in conformance with the rating and performance, which are provided in both the catalog and the specifications. Exceeding the specifications listed may result in inferior performance. It may also cause a short, open, smoking, or flaming to occur, etc.
2. Please use the capacitors in conformance with the operating temperature provided in both the catalog and the specifications. Be especially cautious not to exceed the maximum temperature. In the situation the maximum temperature set forth in both the catalog and specifications is exceeded, the capacitor's insulation resistance may deteriorate, power may suddenly surge and short-circuit may occur. The loss of capacitance will occur, and may self-heat due to equivalent series resistance when alternating electric current is passed through. As this effect becomes critical in high frequency circuits, please exercise with caution. When using the capacitor in a (self-heating) circuit, please make sure the surface of the capacitor remains under the maximum temperature for usage. Also, please make certain temperature rise remain below 20°C.
3. Please keep voltage under the rated voltage, which is applied to the capacitor. Also, please make certain the peak voltage remains below the rated voltage when AC voltage is super-imposed to the DC voltage. In the situation where AC or pulse voltage is employed, ensure average peak voltage does not exceed the rated voltage. Exceeding the rated voltage provided in both catalog and specifications may lead to defective withstanding voltage or, in worse case situations, may cause the capacitor to burn out.
4. It's is a common phenomenon of high-dielectric products to have a deteriorated amount of static electricity due to the application of DC voltage.

【Handling】

Chip capacitors should be handled with care to avoid contamination or damage. The use of vacuum pick-up or plastic tweezers is recommended for manual placement. Tape and reeled packages are suitable for automatic pick and placement machine.

【Flux】

1. An excessive amount of flux or too rapid temperature rise can cause solvent burst, solder can generate a large quantity of gas. The gas can spread small solder particles to cause solder balling effect or bridging problem.
2. Flux containing too high of a percentage of halide may cause corrosion of termination unless sufficient cleaning is applied.
3. Use rosin-type flux. Highly acidic flux (halide content less than 0.2wt%) is not recommended.
4. The water soluble flux causes deteriorated insulation resistance between outer terminations unless sufficiently cleaned.

【Component Spacing】

For wave soldering components, the spacing must be sufficient far apart to prevent bridging or shadowing. This is not so important for reflow process but enough space for rework should be considered. The suggested spacing for reflow soldering and wave soldering is 0.5mm and 1.0mm, respectively.

【Solder Fillet】

Too much solder amount may increase solder stress and cause crack risk. Insufficient solder amount may reduce adhesive strength and cause parts falling off PCB. When soldering, confirm that the solder is placed over 0.2mm of the surface of the terminations.



【Recommended Land Pattern Dimensions】

When mounting the capacitor to substrate, it's important to consider that the amount of solder (size of fillet) used has a direct effect upon the capacitor once it's mounted.

1. The greater the amount of solder, the greater the stress to the elements, as this may cause the substrate to break or crack.
2. In the situation where two or more devices are mounted onto a common land, separate the device into exclusive pads by using soldering resist.
3. Land width equal to or less than component. It is permissible to reduce land width to 80% of component width.



| Size mm (EIA) | L x W (mm) (Dimension tolerance) | a (mm) | b (mm) | c (mm) |
|---------------|-------------------------------------|--------------|--------------|--------------|
| 0402 (01005) | 0.4*0.2 | 0.16 to 0.20 | 0.12 to 0.18 | 0.20 to 0.23 |
| 0603 (0201) | 0.6*0.3 | 0.15 to 0.35 | 0.2 to 0.3 | 0.25 to 0.3 |
| 1005 (0402) | 1.0*0.5 (within±0.10) | 0.3 to 0.5 | 0.35 to 0.45 | 0.4 to 0.5 |
| | 1.0*0.5 (±0.15 or ±0.20) | 0.4 to 0.6 | 0.4 to 0.5 | 0.5 to 0.6 |
| 1608 (0603) | 1.6*0.8 (within±0.10) | 0.7 to 1.0 | 0.6 to 0.8 | 0.7 to 0.8 |
| | 1.6*0.8 (±0.15 or ±0.20) | 0.8 to 1.1 | 0.7 to 0.9 | 0.8 to 0.9 |
| 2012 (0805) | 2.0*1.25 | 1.0 to 1.3 | 0.7 to 0.9 | 1.0 to 1.2 |
| 3216 (1206) | 3.2*1.6 | 2.1 to 2.5 | 1.0 to 1.2 | 1.3 to 1.6 |
| 3225 (1210) | 3.2*2.5 | 2.1 to 2.5 | 1.0 to 1.2 | 2.0 to 2.5 |
| 4520 (1808) | 4.5*2.0 | 3.2 to 3.8 | 1.2 to 1.4 | 1.7 to 2.0 |
| 4532 (1812) | 4.5*3.2 | 3.2 to 3.8 | 1.2 to 1.4 | 2.7 to 3.2 |

【Resin Mold】

If a large amount of resin is used for molding the chip, cracks may occur due to contraction stress during curing. To avoid such cracks, use a low shrinkage resin. The insulation resistance of the chip will degrade due to moisture absorption. Use a low moisture absorption resin. Check carefully that the resin does not generate a decomposition gas or reaction gas during the curing process or during normal storage. Such gases may crack the chip capacitor or damage the device itself.

【Soldering Profile for SMT Process with SnPb Solder Paste】

Reflow Soldering

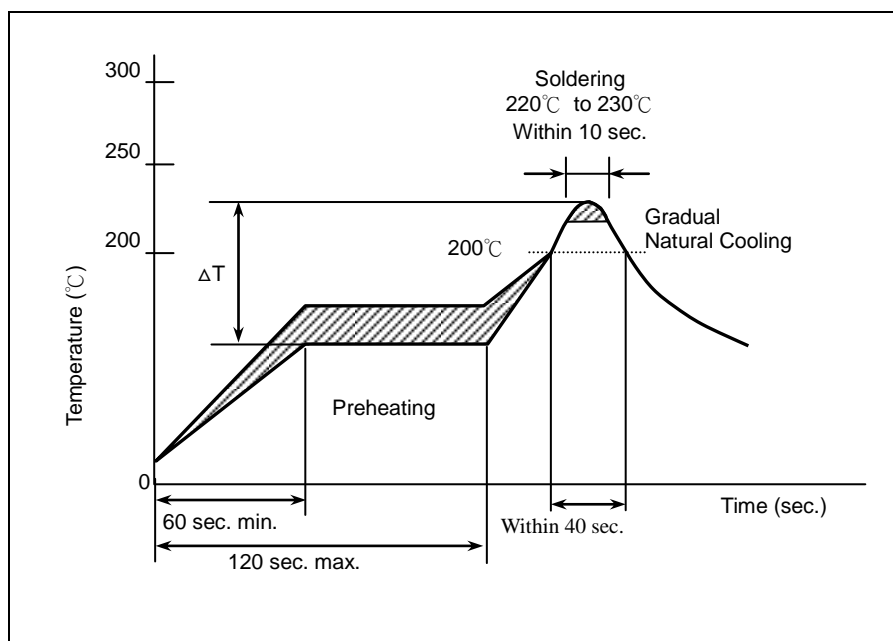

The difference between solder and chip surface should be controlled as following table. The rate of preheat should not exceed 4°C/sec and a target of 2°C/sec is preferred.

| Chip Size | 3216 and smaller | 3225 and above |
|------------|-------------------------------------|-------------------------------------|
| Preheating | $\Delta T \leq 150^{\circ}\text{C}$ | $\Delta T \leq 130^{\circ}\text{C}$ |

Wave Soldering



| Chip Size | 3216 and smaller | 3225 and above |
|------------|-----------------------------------|----------------|
| Preheating | $\Delta T \leq 150^\circ\text{C}$ | - |

Soldering Iron

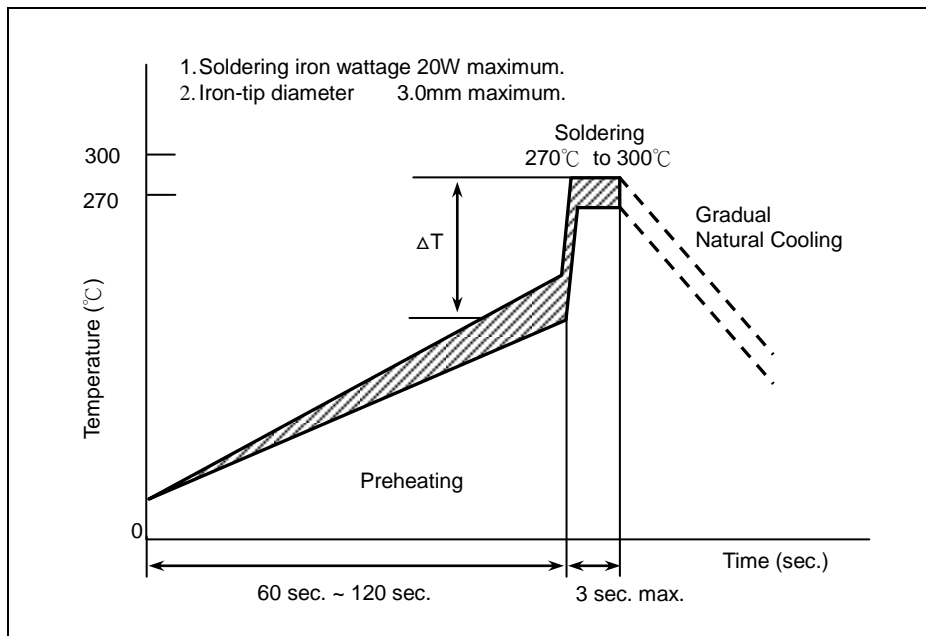

| Chip Size | 3216 and smaller | 3225 and above |
|------------|-----------------------------------|-----------------------------------|
| Preheating | $\Delta T \leq 190^\circ\text{C}$ | $\Delta T \leq 130^\circ\text{C}$ |

MLCC

[Soldering]

Reflow Soldering for Lead free Termination



The difference between solder and chip surface should be controlled as following table. The rate of preheat should not exceed 4°C/sec and a target of 2°C/sec is preferred.

| Chip Size | 3216 and smaller | 3225 and above |
|------------|-----------------------------------|-----------------------------------|
| Preheating | $\Delta T \leq 150^\circ\text{C}$ | $\Delta T \leq 130^\circ\text{C}$ |

Flow Soldering for Lead free Termination



| Chip Size | 3216 and smaller | 3225 and above |
|------------|-----------------------------------|----------------|
| Preheating | $\Delta T \leq 150^\circ\text{C}$ | - |

Soldering Iron

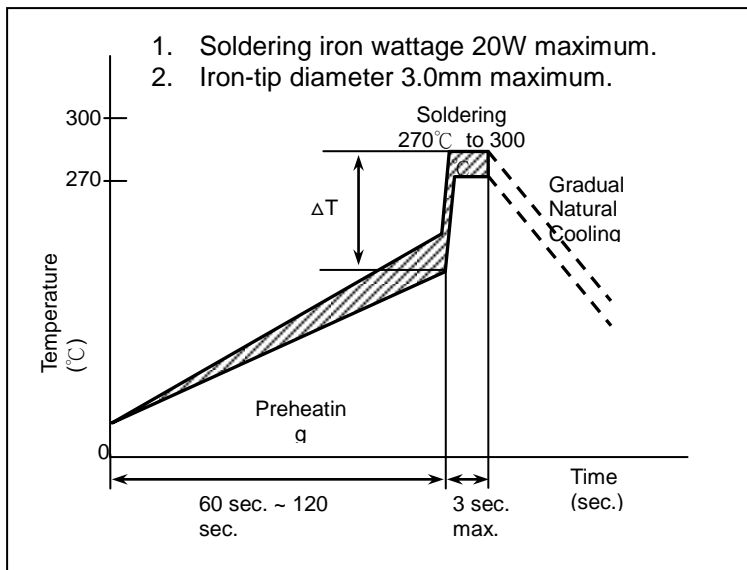

| Chip Size | 3216 and smaller | 3225 and above |
|------------|-------------------------------------|-------------------------------------|
| Preheating | $\Delta T \leq 190^{\circ}\text{C}$ | $\Delta T \leq 130^{\circ}\text{C}$ |

【Chip Layout and Breaking PCB】

- To layout the SMD capacitors for reducing bend stress from board deflection of PCB. The following are examples of Hood and bad layout.

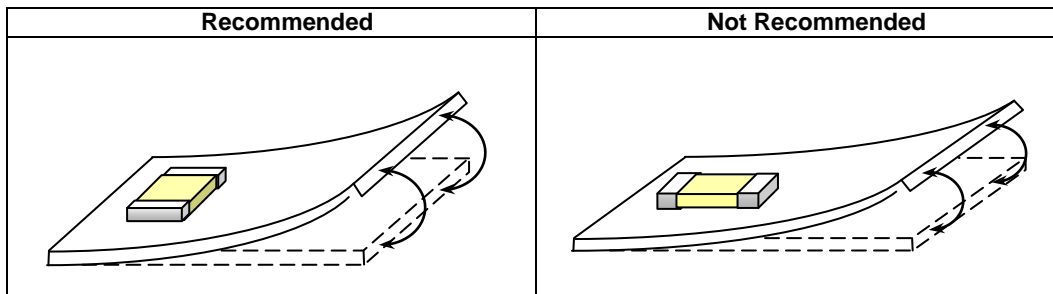

- When breaking PCB, the layout should be noted that the mechanical stresses are depending on the position of capacitors. The following example shows recommendation for better design.

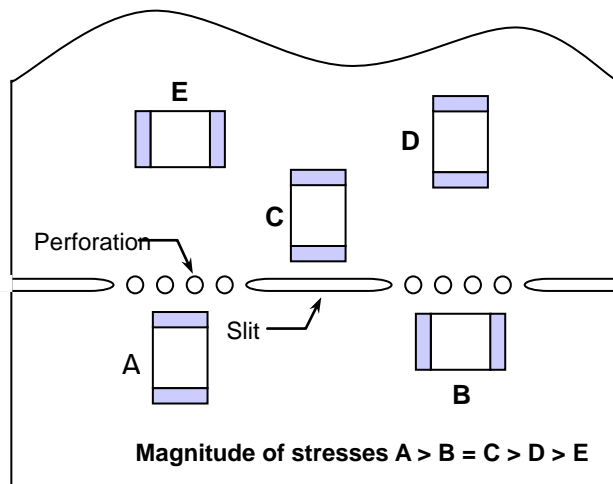

【Temperature Coefficient】

- Class 1 (Temperature Compensation series)



- Class 2 (High Dielectric Constant Series)



[DC Voltage Coefficient]



[Aging Rate]

The capacitance and dissipation factor of class 2 capacitors decreases with time. It is known as 'aging' that follows a logarithmic law and expressed in terms of an aging constant. Aging is caused by a gradual re-alignment of the crystalline structure of the ceramic. The aging constant is defined as the percentage loss of capacitance at a 'time decade'. The law of capacitance aging is expressed as following equation:



$$C_{t2} = C_{t1} \times (1 - k \times \log_{10}(t_2/t_1))$$

C_{t1} : Capacitance after t_1 hours of start aging.

C_{t2} : Capacitance after t_2 hours of start aging.

k : aging constant (capacitance decrease per decade)

t_1, t_2 : time in hours from start of aging.

A typical curve of aging rate is shown in following figure.

When heating the capacitors above Curie temperature (130°C~150°C) the capacitance can be re-new. So capacitance of class 2 capacitors will be complete de-aged by soldering process; subsequently a new aging process begins.

Because of aging, it is specified an age for measurement to meet the prescribed tolerance for class 2 capacitors. Normally, 1000 hours ($t_2=1000$ hrs) is defined.

【Peeling Off Force】

Peeling off force: 0.1N to 1.0 N* in the direction shown as below.

The peeling speed: 300±10 mm/min

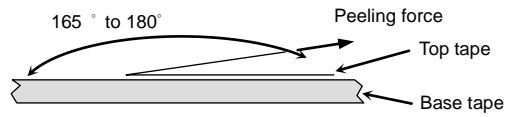

1. The taped tape on reel is wound clockwise. The sprocket holes are to the right as the tape is pulled toward the user.
2. There are minimum 150 mm as the leader and minimum 40 mm empty tape as the tail is attached to the end of the tape.

X-ON Electronics

Largest Supplier of Electrical and Electronic Components

Click to view similar products for [Multilayer Ceramic Capacitors MLCC - SMD/SMT category:](#)

Click to view products by [Darfon manufacturer:](#)

Other Similar products are found below :

[M39014/02-1225V](#) [M39014/22-0631](#) [D55342E07B523DR-T/R](#) [NCA1206X7R103K50TRPF](#) [NCA1206X7R104K16TRPF](#) [NIN-FB391JTRF](#)
[NIN-FC2R7JTRF](#) [NMC0201X5R474K4TRPF](#) [NMC0402NPO220J50TRPF](#) [NMC0402X5R105K6.3TRPF](#) [NMC0402X5R224K6.3TRPF](#)
[NMC0402X7R103J25TRPF](#) [NMC0402X7R153K16TRPF](#) [NMC0603NPO1R8C50TRPF](#) [NMC0603NPO201J50TRPF](#)
[NMC0603NPO330G50TRPF](#) [NMC0603X5R475M6.3TRPF](#) [NMC0805NPO270J50TRPF](#) [NMC0805NPO820J50TRPF](#)
[NMC0805X7R224K16TRPLPF](#) [NMC0805X7R224K25TRPF](#) [NMC1206X7R102K50TRPF](#) [NMC-H0805X7R472K250TRPF](#) [NMC-](#)
[L0402NPO7R0C50TRPF](#) [NMC-L0603NPO2R2B50TRPF](#) [NMC-P0805NPO221J500TRPLPF](#) [NMC-Q0402NPO8R2D200TRPF](#)
[C1206C101J1GAC](#) [C1608C0G2A221J](#) [C1608X7R1E334K](#) [C2012C0G2A472J](#) [2220J2K00562KXT](#) [1812J2K00332KXT](#)
[CDR31BX103AKWR](#) [CDR33BX104AKUR](#) [CDR33BX683AKUS](#) [CGA2B2C0G1H010C](#) [CGA2B2C0G1H040C](#) [CGA2B2C0G1H050C](#)
[CGA2B2C0G1H060D](#) [CGA2B2C0G1H070D](#) [CGA2B2C0G1H120J](#) [CGA2B2C0G1H151J](#) [CGA2B2C0G1H181JT0Y0F](#)
[CGA2B2C0G1H1R5C](#) [CGA2B2C0G1H2R2C](#) [CGA2B2C0G1H390J](#) [CGA2B2C0G1H391J](#) [CGA2B2C0G1H3R3C](#) [CGA2B2C0G1H680J](#)