

**CONTENT (MLCC)**

**E STANDARD NUMBER..... 3**

**STRUCTURE ..... 4**

**ORDERING CODE ..... 4**

**GENERAL PURPOSE ..... 5**

    CLASS I: TEMPERATURE COMPENSATING TYPE ..... 6

    CLASS II: HIGH DIELECTRIC CONSTANT TYPE ..... 12

*X5R Series* ..... 12

*X6S Series* ..... 17

*X7R Series* ..... 19

*X7S Series* ..... 28

*X7T Series* ..... 29

*X7U Series* ..... 30

*Y5V Series* ..... 31

    TEST SPEC. .... 33

**PACKAGE ..... 37**

**OTHERS ..... 41**

**E Standard Number**

|     |     |     |     |     |     |     |     |     |     |     |     |     |     |     |     |     |     |     |     |     |     |     |     |     |
|-----|-----|-----|-----|-----|-----|-----|-----|-----|-----|-----|-----|-----|-----|-----|-----|-----|-----|-----|-----|-----|-----|-----|-----|-----|
| E3  | 1.0 |     |     |     | 2.2 |     |     |     | 4.7 |     |     |     |     |     |     |     |     |     |     |     |     |     |     |     |
| E6  | 1.0 |     | 1.5 |     | 2.2 |     | 3.3 |     | 4.7 |     | 6.8 |     |     |     |     |     |     |     |     |     |     |     |     |     |
| E12 | 1.0 | 1.2 | 1.5 | 1.8 | 2.2 | 2.7 | 3.3 | 3.9 | 4.7 | 5.6 | 6.8 | 8.2 |     |     |     |     |     |     |     |     |     |     |     |     |
| E24 | 1.0 | 1.1 | 1.2 | 1.3 | 1.5 | 1.6 | 1.8 | 2.0 | 2.2 | 2.4 | 2.7 | 3.0 | 3.3 | 3.6 | 3.9 | 4.3 | 4.7 | 5.1 | 5.6 | 6.2 | 6.8 | 7.5 | 8.2 | 9.1 |

## Structure

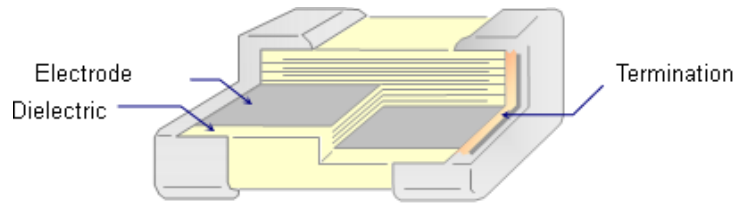

## Ordering Code

**C 1005 NP0 101 J G T S Δ**

### PRODUCT CODE

C = MLCC

### SIZE in mm (EIA CODE, in inch)

0402(01005)    0603(0201)    1005 (0402)    1608 (0603)    2012 (0805)  
 3216 (1206)    3225(1210)    4520 (1808)    4532 (1812)

### T. C.

NP0:  $0 \pm 30\text{ppm}/^\circ\text{C}$      $-55^\circ\text{C}$  to  $+125^\circ\text{C}$     X5R:  $\pm 15\%$      $-55^\circ\text{C}$  to  $+85^\circ\text{C}$   
 X7R:  $\pm 15\%$     X7S:  $\pm 22\%$     X7T:  $+22\%/-33\%$     X7U:  $+22\%/-56\%$      $-55^\circ\text{C}$  to  $+125^\circ\text{C}$   
 X6S:  $\pm 22\%$      $-55^\circ\text{C}$  to  $+105^\circ\text{C}$     Y5V:  $+22\%/-82\%$      $-30^\circ\text{C}$  to  $+85^\circ\text{C}$

### CAPACITANCE CODE

Expressed in pico-farads and identified by a three-digit number.  
 First two digits represent significant figures.  
 Last digit specifies the number of zeros.  
 (Use 9 for 1.0 through 9.9pF ; Use 8 for 0.20 through 0.99pF)

Examples:

| Code | Cap (pF) |
|------|----------|
| 478  | 0.47     |
| 229  | 2.2      |
| 101  | 100      |
| 102  | 1000     |

### TOLERANCE CODE

A:  $\pm 0.05\text{pF}$     B:  $\pm 0.1\text{pF}$     C:  $\pm 0.25\text{pF}$     D:  $\pm 0.5\text{pF}$     F:  $\pm 1\%$     G:  $\pm 2\%$   
 J:  $\pm 5\%$     K:  $\pm 10\%$     M:  $\pm 20\%$     Z:  $+80\%/-20\%$

### VOLTAGE CODE

B: 4V    C: 6.3V    D: 10V    E: 16V    F: 25V    N: 35V    G: 50V    H: 100V  
 J: 200V    K: 250V    L: 500V    M: 630V    P: 1KV    Q: 2KV    R: 3KV    S: 4KV

### PACKAGING CODE

T: Paper tape reel  $\varnothing 180\text{mm}$  (7")    P: Embossed tape reel  $\varnothing 180\text{mm}$  (7")  
 N: Paper tape reel  $\varnothing 250\text{mm}$  (10")    D: Embossed tape reel  $\varnothing 250\text{mm}$  (10")  
 A: Paper tape reel  $\varnothing 330\text{mm}$  (13")    E: Embossed tape reel  $\varnothing 330\text{mm}$  (13")  
 W: Special Packing

### Application Code

S: Standard    Q: High Q/Low ESR    F: Microwave    A: Automotive Infotainment with AEC-Q200

### Thickness Code

| Code    | Thick (mm)     | Code | Thick(mm) | Code | Thick (mm) | Code | Thick (mm) |
|---------|----------------|------|-----------|------|------------|------|------------|
| (blank) | Standard Thick | M    | 0.70      | G    | 1.25       | S    | 1.90       |
| Z       | 0.20           | D    | 0.80      | H    | 1.50       | --   | --         |
| A       | 0.30           | E    | 0.85      | L    | 1.60       | --   | --         |
| Q       | 0.45           | I    | 0.95      | N    | 2.00       | --   | --         |
| B       | 0.50           | J    | 1.00      | P    | 2.50       | --   | --         |
| C       | 0.60           | F    | 1.15      | R    | 3.20       | --   | --         |

## General Purpose

■ External Dimensions



| TYPE            |             | Dimension (mm) |             |          |         |             |
|-----------------|-------------|----------------|-------------|----------|---------|-------------|
| Size (EIA Size) | Kind        | L (Length)     | W (Width)   | T (Max.) | g (Min) | A (Min/Max) |
| C0603 (0201)    | Standard    | 0.6 ± 0.03     | 0.30 ± 0.03 | 0.33     | 0.15    | 0.10 / 0.20 |
|                 | Special (1) | 0.6 ± 0.05     | 0.30 ± 0.05 | 0.35     |         |             |
|                 | Special (2) | 0.6 ± 0.09     | 0.30 ± 0.09 | 0.39     |         | 0.10 / 0.25 |
| C1005 (0402)    | Standard    | 1.0 ± 0.05     | 0.50 ± 0.05 | 0.55     | 0.30    | 0.15 / 0.35 |
|                 | Special (1) | 1.0 ± 0.10     | 0.50 ± 0.10 | 0.60     |         |             |
|                 | Special (2) | 1.0 ± 0.15     | 0.50 ± 0.15 | 0.65     |         |             |
| C1608 (0603)    | Standard    | 1.0 ± 0.20     | 0.50 ± 0.20 | 0.70     | 0.50    | 0.25 / 0.65 |
|                 | Special (1) | 1.6 ± 0.10     | 0.80 ± 0.10 | 0.90     |         |             |
|                 | Special (2) | 1.6 ± 0.15     | 0.80 ± 0.15 | 0.95     |         |             |
| C2012 (0805)    | Standard    | 1.6 ± 0.20     | 0.80 ± 0.20 | 1.00     | 0.70    | 0.25 / 0.75 |
|                 | Special (1) | 1.6 ± 0.25     | 0.80 ± 0.25 | 1.05     |         |             |
|                 | Standard    | 2.0 ± 0.15     | 1.25 ± 0.15 | 1.45     |         |             |
| C3216 (1206)    | Standard    | 2.0 ± 0.20     | 1.25 ± 0.20 | 1.45     | 1.50    | 0.25 / 0.75 |
|                 | Special (1) | 3.2 ± 0.15     | 1.60 ± 0.15 | 1.80     |         |             |
|                 | Special (2) | 3.2 ± 0.20     | 1.60 ± 0.20 | 1.90     |         |             |
| C3225 (1210)    | Standard    | 3.2 ± 0.30     | 1.60 ± 0.30 | 1.90     | 1.50    | 0.3 / 0.90  |
|                 | Special (1) | 3.2 ± 0.30     | 2.50 ± 0.20 | 2.80     |         |             |
|                 | Special (1) | 3.2 ± 0.40     | 2.50 ± 0.30 | 2.80     |         |             |

For special parts, please see the "Part Number & Characteristic" for detail specification.

## ● Class I: Temperature Compensating Type

### ■ Feature

1. Ultra-stable
2. Tight tolerance available
3. Low ESR (Frequency is within 800MHz)
4. Good frequency performance
5. No aging of capacitance
6. RoHS compliant
7. Halogen Free

### ■ Application

1. LC and RC tuned circuit
2. Filtering
3. Timing

### ■ Part Number & Characteristic

#### ● C0603NP0\_S Series (EIA0201)

| RV          | DARFON P/N  | DARFON P/N 2 | Measuring Condition | Capacitance |             | Available Tolerance    | Thick. (mm) | Tolerance(mm) |        | DF (max.) | Standard Packing |
|-------------|-------------|--------------|---------------------|-------------|-------------|------------------------|-------------|---------------|--------|-----------|------------------|
|             |             |              |                     | Value       | Unit        |                        |             | L/W           | Thick. |           |                  |
| 50V         | C0603NP0208 | C0603NP0208  | 1V, 1MHz            | 0.20        | pF          | ±0.25pF,±0.1pF,±0.05pF | 0.30        | ±0.03         | ±0.03  | 0.25%     | Paper,15Kpcs     |
|             | C0603NP0308 | C0603NP0308  | 1V, 1MHz            | 0.30        | pF          | ±0.25pF,±0.1pF,±0.05pF | 0.30        | ±0.03         | ±0.03  | 0.25%     |                  |
|             | C0603NP0408 | C0603NP0408  | 1V, 1MHz            | 0.40        | pF          | ±0.25pF,±0.1pF,±0.05pF | 0.30        | ±0.03         | ±0.03  | 0.25%     |                  |
|             | C0603NP0508 | C0603NP0508  | 1V, 1MHz            | 0.50        | pF          | ±0.25pF,±0.1pF,±0.05pF | 0.30        | ±0.03         | ±0.03  | 0.24%     |                  |
|             | C0603NP0608 | C0603NP0608  | 1V, 1MHz            | 0.60        | pF          | ±0.25pF,±0.1pF,±0.05pF | 0.30        | ±0.03         | ±0.03  | 0.24%     |                  |
|             | C0603NP0708 | C0603NP0708  | 1V, 1MHz            | 0.70        | pF          | ±0.25pF,±0.1pF,±0.05pF | 0.30        | ±0.03         | ±0.03  | 0.24%     |                  |
|             | C0603NP0758 | C0603NP0758  | 1V, 1MHz            | 0.75        | pF          | ±0.25pF,±0.1pF,±0.05pF | 0.30        | ±0.03         | ±0.03  | 0.24%     |                  |
|             | C0603NP0808 | C0603NP0808  | 1V, 1MHz            | 0.80        | pF          | ±0.25pF,±0.1pF,±0.05pF | 0.30        | ±0.03         | ±0.03  | 0.24%     |                  |
|             | C0603NP0908 | C0603NP0908  | 1V, 1MHz            | 0.90        | pF          | ±0.25pF,±0.1pF,±0.05pF | 0.30        | ±0.03         | ±0.03  | 0.24%     |                  |
|             | C0603NP0109 | C0603NP0109  | 1V, 1MHz            | 1.0         | pF          | ±0.25pF,±0.1pF,±0.05pF | 0.30        | ±0.03         | ±0.03  | 0.24%     |                  |
|             | C0603NP0119 | C0603NP0119  | 1V, 1MHz            | 1.1         | pF          | ±0.25pF,±0.1pF         | 0.30        | ±0.03         | ±0.03  | 0.24%     |                  |
|             | C0603NP0129 | C0603NP0129  | 1V, 1MHz            | 1.2         | pF          | ±0.25pF,±0.1pF         | 0.30        | ±0.03         | ±0.03  | 0.24%     |                  |
|             | C0603NP0139 | C0603NP0139  | 1V, 1MHz            | 1.3         | pF          | ±0.25pF,±0.1pF         | 0.30        | ±0.03         | ±0.03  | 0.23%     |                  |
|             | C0603NP0159 | C0603NP0159  | 1V, 1MHz            | 1.5         | pF          | ±0.25pF,±0.1pF         | 0.30        | ±0.03         | ±0.03  | 0.23%     |                  |
|             | C0603NP0169 | C0603NP0169  | 1V, 1MHz            | 1.6         | pF          | ±0.25pF,±0.1pF         | 0.30        | ±0.03         | ±0.03  | 0.23%     |                  |
|             | C0603NP0189 | C0603NP0189  | 1V, 1MHz            | 1.8         | pF          | ±0.25pF,±0.1pF         | 0.30        | ±0.03         | ±0.03  | 0.23%     |                  |
|             | C0603NP0209 | C0603NP0209  | 1V, 1MHz            | 2.0         | pF          | ±0.25pF,±0.1pF         | 0.30        | ±0.03         | ±0.03  | 0.23%     |                  |
|             | C0603NP0229 | C0603NP0229  | 1V, 1MHz            | 2.2         | pF          | ±0.25pF,±0.1pF         | 0.30        | ±0.03         | ±0.03  | 0.23%     |                  |
|             | C0603NP0249 | C0603NP0249  | 1V, 1MHz            | 2.4         | pF          | ±0.25pF,±0.1pF         | 0.30        | ±0.03         | ±0.03  | 0.22%     |                  |
|             | C0603NP0279 | C0603NP0279  | 1V, 1MHz            | 2.7         | pF          | ±0.25pF,±0.1pF         | 0.30        | ±0.03         | ±0.03  | 0.22%     |                  |
|             | C0603NP0309 | C0603NP0309  | 1V, 1MHz            | 3.0         | pF          | ±0.25pF,±0.1pF         | 0.30        | ±0.03         | ±0.03  | 0.22%     |                  |
|             | C0603NP0339 | C0603NP0339  | 1V, 1MHz            | 3.3         | pF          | ±0.25pF,±0.1pF         | 0.30        | ±0.03         | ±0.03  | 0.21%     |                  |
|             | C0603NP0359 | C0603NP0359  | 1V, 1MHz            | 3.5         | pF          | ±0.25pF,±0.1pF         | 0.30        | ±0.03         | ±0.03  | 0.21%     |                  |
|             | C0603NP0399 | C0603NP0399  | 1V, 1MHz            | 3.9         | pF          | ±0.25pF,±0.1pF         | 0.30        | ±0.03         | ±0.03  | 0.21%     |                  |
|             | C0603NP0409 | C0603NP0409  | 1V, 1MHz            | 4.0         | pF          | ±0.25pF,±0.1pF         | 0.30        | ±0.03         | ±0.03  | 0.21%     |                  |
|             | C0603NP0439 | C0603NP0439  | 1V, 1MHz            | 4.3         | pF          | ±0.25pF,±0.1pF         | 0.30        | ±0.03         | ±0.03  | 0.21%     |                  |
|             | C0603NP0479 | C0603NP0479  | 1V, 1MHz            | 4.7         | pF          | ±0.25pF,±0.1pF         | 0.30        | ±0.03         | ±0.03  | 0.20%     |                  |
|             | C0603NP0509 | C0603NP0509  | 1V, 1MHz            | 5.0         | pF          | ±0.5pF,±0.25pF,±0.1pF  | 0.30        | ±0.03         | ±0.03  | 0.20%     |                  |
|             | C0603NP0519 | C0603NP0519  | 1V, 1MHz            | 5.1         | pF          | ±0.5pF,±0.25pF,±0.1pF  | 0.30        | ±0.03         | ±0.03  | 0.20%     |                  |
|             | C0603NP0569 | C0603NP0569  | 1V, 1MHz            | 5.6         | pF          | ±0.5pF,±0.25pF,±0.1pF  | 0.30        | ±0.03         | ±0.03  | 0.20%     |                  |
|             | C0603NP0609 | C0603NP0609  | 1V, 1MHz            | 6.0         | pF          | ±0.5pF,±0.25pF,±0.1pF  | 0.30        | ±0.03         | ±0.03  | 0.19%     |                  |
|             | C0603NP0629 | C0603NP0629  | 1V, 1MHz            | 6.2         | pF          | ±0.5pF,±0.25pF,±0.1pF  | 0.30        | ±0.03         | ±0.03  | 0.19%     |                  |
|             | C0603NP0689 | C0603NP0689  | 1V, 1MHz            | 6.8         | pF          | ±0.5pF,±0.25pF,±0.1pF  | 0.30        | ±0.03         | ±0.03  | 0.19%     |                  |
|             | C0603NP0709 | C0603NP0709  | 1V, 1MHz            | 7.0         | pF          | ±0.5pF,±0.25pF,±0.1pF  | 0.30        | ±0.03         | ±0.03  | 0.19%     |                  |
|             | C0603NP0759 | C0603NP0759  | 1V, 1MHz            | 7.5         | pF          | ±0.5pF,±0.25pF,±0.1pF  | 0.30        | ±0.03         | ±0.03  | 0.18%     |                  |
|             | C0603NP0809 | C0603NP0809  | 1V, 1MHz            | 8.0         | pF          | ±0.5pF,±0.25pF,±0.1pF  | 0.30        | ±0.03         | ±0.03  | 0.18%     |                  |
|             | C0603NP0829 | C0603NP0829  | 1V, 1MHz            | 8.2         | pF          | ±0.5pF,±0.25pF,±0.1pF  | 0.30        | ±0.03         | ±0.03  | 0.18%     |                  |
|             | C0603NP0909 | C0603NP0909  | 1V, 1MHz            | 9.0         | pF          | ±0.5pF,±0.25pF,±0.1pF  | 0.30        | ±0.03         | ±0.03  | 0.17%     |                  |
|             | C0603NP0100 | C0603NP0100  | 1V, 1MHz            | 10          | pF          | ±5%,±2%,±1%            | 0.30        | ±0.03         | ±0.03  | 0.17%     |                  |
|             | C0603NP0120 | C0603NP0120  | 1V, 1MHz            | 12          | pF          | ±5%,±2%,±1%            | 0.30        | ±0.03         | ±0.03  | 0.16%     |                  |
| C0603NP0150 | C0603NP0150 | 1V, 1MHz     | 15                  | pF          | ±5%,±2%,±1% | 0.30                   | ±0.03       | ±0.03         | 0.14%  |           |                  |
| C0603NP0180 | C0603NP0180 | 1V, 1MHz     | 18                  | pF          | ±5%,±2%,±1% | 0.30                   | ±0.03       | ±0.03         | 0.13%  |           |                  |
| C0603NP0200 | C0603NP0200 | 1V, 1MHz     | 20                  | pF          | ±5%,±2%,±1% | 0.30                   | ±0.03       | ±0.03         | 0.13%  |           |                  |
| C0603NP0220 | C0603NP0220 | 1V, 1MHz     | 22                  | pF          | ±5%,±2%,±1% | 0.30                   | ±0.03       | ±0.03         | 0.12%  |           |                  |
| C0603NP0270 | C0603NP0270 | 1V, 1MHz     | 27                  | pF          | ±5%,±2%,±1% | 0.30                   | ±0.03       | ±0.03         | 0.11%  |           |                  |
| C0603NP0330 | C0603NP0330 | 1V, 1MHz     | 33                  | pF          | ±5%,±2%,±1% | 0.30                   | ±0.03       | ±0.03         | 0.10%  |           |                  |
| C0603NP0390 | C0603NP0390 | 1V, 1MHz     | 39                  | pF          | ±5%,±2%,±1% | 0.30                   | ±0.03       | ±0.03         | 0.10%  |           |                  |
| C0603NP0470 | C0603NP0470 | 1V, 1MHz     | 47                  | pF          | ±5%,±2%,±1% | 0.30                   | ±0.03       | ±0.03         | 0.10%  |           |                  |
| C0603NP0560 | C0603NP0560 | 1V, 1MHz     | 56                  | pF          | ±5%,±2%,±1% | 0.30                   | ±0.03       | ±0.03         | 0.10%  |           |                  |
| C0603NP0680 | C0603NP0680 | 1V, 1MHz     | 68                  | pF          | ±5%,±2%,±1% | 0.30                   | ±0.03       | ±0.03         | 0.10%  |           |                  |
| C0603NP0820 | C0603NP0820 | 1V, 1MHz     | 82                  | pF          | ±5%,±2%,±1% | 0.30                   | ±0.03       | ±0.03         | 0.10%  |           |                  |
| C0603NP0101 | C0603NP0101 | 1V, 1MHz     | 100                 | pF          | ±5%,±2%,±1% | 0.30                   | ±0.03       | ±0.03         | 0.10%  |           |                  |

□ Tolerance Code: A=±0.05 pF, B=±0.1pF, C=±0.25pF, D=±0.5pF, F=±1%, G=±2%, J=±5%; Special tolerance on the request.

| RV          | DARFON P/N  | DARFON P/N 2 | Measuring Condition | Capacitance |             | Available Tolerance    | Thick. (mm) | Tolerance(mm) |        | DF (max.) | Standard Packing |
|-------------|-------------|--------------|---------------------|-------------|-------------|------------------------|-------------|---------------|--------|-----------|------------------|
|             |             |              |                     | Value       | Unit        |                        |             | L/W           | Thick. |           |                  |
| 25V         | C0603NP0208 | C0603NP0208  | 1V, 1MHz            | 0.20        | pF          | ±0.25pF,±0.1pF,±0.05pF | 0.30        | ±0.03         | ±0.03  | 0.25%     | Paper,15Kpcs     |
|             | C0603NP0308 | C0603NP0308  | 1V, 1MHz            | 0.30        | pF          | ±0.25pF,±0.1pF,±0.05pF | 0.30        | ±0.03         | ±0.03  | 0.25%     |                  |
|             | C0603NP0408 | C0603NP0408  | 1V, 1MHz            | 0.40        | pF          | ±0.25pF,±0.1pF,±0.05pF | 0.30        | ±0.03         | ±0.03  | 0.25%     |                  |
|             | C0603NP0508 | C0603NP0508  | 1V, 1MHz            | 0.50        | pF          | ±0.25pF,±0.1pF,±0.05pF | 0.30        | ±0.03         | ±0.03  | 0.24%     |                  |
|             | C0603NP0608 | C0603NP0608  | 1V, 1MHz            | 0.60        | pF          | ±0.25pF,±0.1pF,±0.05pF | 0.30        | ±0.03         | ±0.03  | 0.24%     |                  |
|             | C0603NP0708 | C0603NP0708  | 1V, 1MHz            | 0.70        | pF          | ±0.25pF,±0.1pF,±0.05pF | 0.30        | ±0.03         | ±0.03  | 0.24%     |                  |
|             | C0603NP0758 | C0603NP0758  | 1V, 1MHz            | 0.75        | pF          | ±0.25pF,±0.1pF,±0.05pF | 0.30        | ±0.03         | ±0.03  | 0.24%     |                  |
|             | C0603NP0808 | C0603NP0808  | 1V, 1MHz            | 0.80        | pF          | ±0.25pF,±0.1pF,±0.05pF | 0.30        | ±0.03         | ±0.03  | 0.24%     |                  |
|             | C0603NP0908 | C0603NP0908  | 1V, 1MHz            | 0.90        | pF          | ±0.25pF,±0.1pF,±0.05pF | 0.30        | ±0.03         | ±0.03  | 0.24%     |                  |
|             | C0603NP0109 | C0603NP0109  | 1V, 1MHz            | 1.0         | pF          | ±0.25pF,±0.1pF,±0.05pF | 0.30        | ±0.03         | ±0.03  | 0.24%     |                  |
|             | C0603NP0129 | C0603NP0129  | 1V, 1MHz            | 1.2         | pF          | ±0.25pF,±0.1pF         | 0.30        | ±0.03         | ±0.03  | 0.24%     |                  |
|             | C0603NP0139 | C0603NP0139  | 1V, 1MHz            | 1.3         | pF          | ±0.25pF,±0.1pF         | 0.30        | ±0.03         | ±0.03  | 0.23%     |                  |
|             | C0603NP0159 | C0603NP0159  | 1V, 1MHz            | 1.5         | pF          | ±0.25pF,±0.1pF         | 0.30        | ±0.03         | ±0.03  | 0.23%     |                  |
|             | C0603NP0169 | C0603NP0169  | 1V, 1MHz            | 1.6         | pF          | ±0.25pF,±0.1pF         | 0.30        | ±0.03         | ±0.03  | 0.23%     |                  |
|             | C0603NP0189 | C0603NP0189  | 1V, 1MHz            | 1.8         | pF          | ±0.25pF,±0.1pF         | 0.30        | ±0.03         | ±0.03  | 0.23%     |                  |
|             | C0603NP0209 | C0603NP0209  | 1V, 1MHz            | 2.0         | pF          | ±0.25pF,±0.1pF         | 0.30        | ±0.03         | ±0.03  | 0.23%     |                  |
|             | C0603NP0229 | C0603NP0229  | 1V, 1MHz            | 2.2         | pF          | ±0.25pF,±0.1pF         | 0.30        | ±0.03         | ±0.03  | 0.23%     |                  |
|             | C0603NP0279 | C0603NP0279  | 1V, 1MHz            | 2.7         | pF          | ±0.25pF,±0.1pF         | 0.30        | ±0.03         | ±0.03  | 0.22%     |                  |
|             | C0603NP0309 | C0603NP0309  | 1V, 1MHz            | 3.0         | pF          | ±0.25pF,±0.1pF         | 0.30        | ±0.03         | ±0.03  | 0.22%     |                  |
|             | C0603NP0339 | C0603NP0339  | 1V, 1MHz            | 3.3         | pF          | ±0.25pF,±0.1pF         | 0.30        | ±0.03         | ±0.03  | 0.21%     |                  |
|             | C0603NP0359 | C0603NP0359  | 1V, 1MHz            | 3.5         | pF          | ±0.25pF,±0.1pF         | 0.30        | ±0.03         | ±0.03  | 0.21%     |                  |
|             | C0603NP0399 | C0603NP0399  | 1V, 1MHz            | 3.9         | pF          | ±0.25pF,±0.1pF         | 0.30        | ±0.03         | ±0.03  | 0.21%     |                  |
|             | C0603NP0409 | C0603NP0409  | 1V, 1MHz            | 4.0         | pF          | ±0.25pF,±0.1pF         | 0.30        | ±0.03         | ±0.03  | 0.21%     |                  |
|             | C0603NP0439 | C0603NP0439  | 1V, 1MHz            | 4.3         | pF          | ±0.25pF,±0.1pF         | 0.30        | ±0.03         | ±0.03  | 0.21%     |                  |
|             | C0603NP0479 | C0603NP0479  | 1V, 1MHz            | 4.7         | pF          | ±0.25pF,±0.1pF         | 0.30        | ±0.03         | ±0.03  | 0.20%     |                  |
|             | C0603NP0509 | C0603NP0509  | 1V, 1MHz            | 5.0         | pF          | ±0.5pF,±0.25pF,±0.1pF  | 0.30        | ±0.03         | ±0.03  | 0.20%     |                  |
|             | C0603NP0519 | C0603NP0519  | 1V, 1MHz            | 5.1         | pF          | ±0.5pF,±0.25pF,±0.1pF  | 0.30        | ±0.03         | ±0.03  | 0.20%     |                  |
|             | C0603NP0569 | C0603NP0569  | 1V, 1MHz            | 5.6         | pF          | ±0.5pF,±0.25pF,±0.1pF  | 0.30        | ±0.03         | ±0.03  | 0.20%     |                  |
|             | C0603NP0609 | C0603NP0609  | 1V, 1MHz            | 6.0         | pF          | ±0.5pF,±0.25pF,±0.1pF  | 0.30        | ±0.03         | ±0.03  | 0.19%     |                  |
|             | C0603NP0629 | C0603NP0629  | 1V, 1MHz            | 6.2         | pF          | ±0.5pF,±0.25pF,±0.1pF  | 0.30        | ±0.03         | ±0.03  | 0.19%     |                  |
|             | C0603NP0689 | C0603NP0689  | 1V, 1MHz            | 6.8         | pF          | ±0.5pF,±0.25pF,±0.1pF  | 0.30        | ±0.03         | ±0.03  | 0.19%     |                  |
|             | C0603NP0709 | C0603NP0709  | 1V, 1MHz            | 7.0         | pF          | ±0.5pF,±0.25pF,±0.1pF  | 0.30        | ±0.03         | ±0.03  | 0.19%     |                  |
|             | C0603NP0759 | C0603NP0759  | 1V, 1MHz            | 7.5         | pF          | ±0.5pF,±0.25pF,±0.1pF  | 0.30        | ±0.03         | ±0.03  | 0.18%     |                  |
|             | C0603NP0809 | C0603NP0809  | 1V, 1MHz            | 8.0         | pF          | ±0.5pF,±0.25pF,±0.1pF  | 0.30        | ±0.03         | ±0.03  | 0.18%     |                  |
|             | C0603NP0829 | C0603NP0829  | 1V, 1MHz            | 8.2         | pF          | ±0.5pF,±0.25pF,±0.1pF  | 0.30        | ±0.03         | ±0.03  | 0.18%     |                  |
|             | C0603NP0909 | C0603NP0909  | 1V, 1MHz            | 9.0         | pF          | ±0.5pF,±0.25pF,±0.1pF  | 0.30        | ±0.03         | ±0.03  | 0.17%     |                  |
|             | C0603NP0919 | C0603NP0919  | 1V, 1MHz            | 9.1         | pF          | ±0.5pF,±0.25pF,±0.1pF  | 0.30        | ±0.03         | ±0.03  | 0.17%     |                  |
|             | C0603NP0100 | C0603NP0100  | 1V, 1MHz            | 10          | pF          | ±5%,±2%,±1%            | 0.30        | ±0.03         | ±0.03  | 0.17%     |                  |
|             | C0603NP0120 | C0603NP0120  | 1V, 1MHz            | 12          | pF          | ±5%,±2%,±1%            | 0.30        | ±0.03         | ±0.03  | 0.16%     |                  |
|             | C0603NP0150 | C0603NP0150  | 1V, 1MHz            | 15          | pF          | ±5%,±2%,±1%            | 0.30        | ±0.03         | ±0.03  | 0.14%     |                  |
| C0603NP0180 | C0603NP0180 | 1V, 1MHz     | 18                  | pF          | ±5%,±2%,±1% | 0.30                   | ±0.03       | ±0.03         | 0.13%  |           |                  |
| C0603NP0200 | C0603NP0200 | 1V, 1MHz     | 20                  | pF          | ±5%,±2%,±1% | 0.30                   | ±0.03       | ±0.03         | 0.13%  |           |                  |
| C0603NP0220 | C0603NP0220 | 1V, 1MHz     | 22                  | pF          | ±5%,±2%,±1% | 0.30                   | ±0.03       | ±0.03         | 0.12%  |           |                  |
| C0603NP0240 | C0603NP0240 | 1V, 1MHz     | 24                  | pF          | ±5%,±2%,±1% | 0.30                   | ±0.03       | ±0.03         | 0.11%  |           |                  |
| C0603NP0270 | C0603NP0270 | 1V, 1MHz     | 27                  | pF          | ±5%,±2%,±1% | 0.30                   | ±0.03       | ±0.03         | 0.11%  |           |                  |
| C0603NP0300 | C0603NP0300 | 1V, 1MHz     | 30                  | pF          | ±5%         | 0.30                   | ±0.03       | ±0.03         | 0.10%  |           |                  |
| C0603NP0330 | C0603NP0330 | 1V, 1MHz     | 33                  | pF          | ±5%,±2%,±1% | 0.30                   | ±0.03       | ±0.03         | 0.10%  |           |                  |
| C0603NP0390 | C0603NP0390 | 1V, 1MHz     | 39                  | pF          | ±5%,±2%,±1% | 0.30                   | ±0.03       | ±0.03         | 0.10%  |           |                  |
| C0603NP0470 | C0603NP0470 | 1V, 1MHz     | 47                  | pF          | ±5%,±2%,±1% | 0.30                   | ±0.03       | ±0.03         | 0.10%  |           |                  |
| C0603NP0560 | C0603NP0560 | 1V, 1MHz     | 56                  | pF          | ±5%,±2%,±1% | 0.30                   | ±0.03       | ±0.03         | 0.10%  |           |                  |
| C0603NP0680 | C0603NP0680 | 1V, 1MHz     | 68                  | pF          | ±5%,±2%,±1% | 0.30                   | ±0.03       | ±0.03         | 0.10%  |           |                  |
| C0603NP0820 | C0603NP0820 | 1V, 1MHz     | 82                  | pF          | ±5%,±2%,±1% | 0.30                   | ±0.03       | ±0.03         | 0.10%  |           |                  |
| C0603NP0101 | C0603NP0101 | 1V, 1MHz     | 100                 | pF          | ±5%,±2%,±1% | 0.30                   | ±0.03       | ±0.03         | 0.10%  |           |                  |
| 16V         | C0603NP0279 | C0603NP0279  | 1V, 1MHz            | 2.7         | pF          | ±0.25pF,±0.1pF         | 0.30        | ±0.03         | ±0.03  | 0.22%     | Paper,15Kpcs     |
|             | C0603NP0330 | C0603NP0330  | 1V, 1MHz            | 33          | pF          | ±5%,±2%,±1%            | 0.30        | ±0.03         | ±0.03  | 0.10%     |                  |

● C1005NP0\_S Series (EIA0402)

| RV          | DARFON P/N  | DARFON P/N 2 | Measuring Condition | Capacitance |          | Available Tolerance | Thick. (mm)      | Tolerance(mm)          |        | DF (max.) | Standard Packing |       |
|-------------|-------------|--------------|---------------------|-------------|----------|---------------------|------------------|------------------------|--------|-----------|------------------|-------|
|             |             |              |                     | Value       | Unit     |                     |                  | L/W                    | Thick. |           |                  |       |
| 50V         | C1005NP0208 | GTS          | C1005NP0208         | GT          | 1V, 1MHz | 0.20                | pF               | ±0.25pF,±0.1pF,±0.05pF | 0.50   | ±0.05     | ±0.05            | 0.25% |
|             | C1005NP0308 | GTS          | C1005NP0308         | GT          | 1V, 1MHz | 0.30                | pF               | ±0.25pF,±0.1pF,±0.05pF | 0.50   | ±0.05     | ±0.05            | 0.25% |
|             | C1005NP0408 | GTS          | C1005NP0408         | GT          | 1V, 1MHz | 0.40                | pF               | ±0.25pF,±0.1pF,±0.05pF | 0.50   | ±0.05     | ±0.05            | 0.25% |
|             | C1005NP0508 | GTS          | C1005NP0508         | GT          | 1V, 1MHz | 0.50                | pF               | ±0.25pF,±0.1pF,±0.05pF | 0.50   | ±0.05     | ±0.05            | 0.24% |
|             | C1005NP0608 | GTS          | C1005NP0608         | GT          | 1V, 1MHz | 0.60                | pF               | ±0.25pF,±0.1pF,±0.05pF | 0.50   | ±0.05     | ±0.05            | 0.24% |
|             | C1005NP0688 | GTS          | C1005NP0688         | GT          | 1V, 1MHz | 0.68                | pF               | ±0.25pF,±0.1pF,±0.05pF | 0.50   | ±0.05     | ±0.05            | 0.24% |
|             | C1005NP0708 | GTS          | C1005NP0708         | GT          | 1V, 1MHz | 0.70                | pF               | ±0.25pF,±0.1pF,±0.05pF | 0.50   | ±0.05     | ±0.05            | 0.24% |
|             | C1005NP0808 | GTS          | C1005NP0808         | GT          | 1V, 1MHz | 0.80                | pF               | ±0.25pF,±0.1pF,±0.05pF | 0.50   | ±0.05     | ±0.05            | 0.24% |
|             | C1005NP0828 | GTS          | C1005NP0828         | GT          | 1V, 1MHz | 0.82                | pF               | ±0.25pF,±0.1pF,±0.05pF | 0.50   | ±0.05     | ±0.05            | 0.24% |
|             | C1005NP0908 | GTS          | C1005NP0908         | GT          | 1V, 1MHz | 0.90                | pF               | ±0.25pF,±0.1pF,±0.05pF | 0.50   | ±0.05     | ±0.05            | 0.24% |
|             | C1005NP0109 | GTS          | C1005NP0109         | GT          | 1V, 1MHz | 1.0                 | pF               | ±0.25pF,±0.1pF,±0.05pF | 0.50   | ±0.05     | ±0.05            | 0.24% |
|             | C1005NP0129 | GTS          | C1005NP0129         | GT          | 1V, 1MHz | 1.2                 | pF               | ±0.25pF,±0.1pF,±0.05pF | 0.50   | ±0.05     | ±0.05            | 0.24% |
|             | C1005NP0139 | GTS          | C1005NP0139         | GT          | 1V, 1MHz | 1.3                 | pF               | ±0.25pF,±0.1pF,±0.05pF | 0.50   | ±0.05     | ±0.05            | 0.23% |
|             | C1005NP0159 | GTS          | C1005NP0159         | GT          | 1V, 1MHz | 1.5                 | pF               | ±0.25pF,±0.1pF,±0.05pF | 0.50   | ±0.05     | ±0.05            | 0.23% |
|             | C1005NP0189 | GTS          | C1005NP0189         | GT          | 1V, 1MHz | 1.8                 | pF               | ±0.25pF,±0.1pF,±0.05pF | 0.50   | ±0.05     | ±0.05            | 0.23% |
|             | C1005NP0209 | GTS          | C1005NP0209         | GT          | 1V, 1MHz | 2.0                 | pF               | ±0.25pF,±0.1pF,±0.05pF | 0.50   | ±0.05     | ±0.05            | 0.23% |
|             | C1005NP0229 | GTS          | C1005NP0229         | GT          | 1V, 1MHz | 2.2                 | pF               | ±0.25pF,±0.1pF,±0.05pF | 0.50   | ±0.05     | ±0.05            | 0.23% |
|             | C1005NP0249 | GTS          | C1005NP0249         | GT          | 1V, 1MHz | 2.4                 | pF               | ±0.25pF,±0.1pF,±0.05pF | 0.50   | ±0.05     | ±0.05            | 0.22% |
|             | C1005NP0259 | GTS          | C1005NP0259         | GT          | 1V, 1MHz | 2.5                 | pF               | ±0.25pF,±0.1pF,±0.05pF | 0.50   | ±0.05     | ±0.05            | 0.22% |
|             | C1005NP0279 | GTS          | C1005NP0279         | GT          | 1V, 1MHz | 2.7                 | pF               | ±0.25pF,±0.1pF,±0.05pF | 0.50   | ±0.05     | ±0.05            | 0.22% |
|             | C1005NP0309 | GTS          | C1005NP0309         | GT          | 1V, 1MHz | 3.0                 | pF               | ±0.25pF,±0.1pF,±0.05pF | 0.50   | ±0.05     | ±0.05            | 0.22% |
|             | C1005NP0339 | GTS          | C1005NP0339         | GT          | 1V, 1MHz | 3.3                 | pF               | ±0.25pF,±0.1pF,±0.05pF | 0.50   | ±0.05     | ±0.05            | 0.21% |
|             | C1005NP0369 | GTS          | C1005NP0369         | GT          | 1V, 1MHz | 3.6                 | pF               | ±0.25pF,±0.1pF,±0.05pF | 0.50   | ±0.05     | ±0.05            | 0.21% |
|             | C1005NP0399 | GTS          | C1005NP0399         | GT          | 1V, 1MHz | 3.9                 | pF               | ±0.25pF,±0.1pF,±0.05pF | 0.50   | ±0.05     | ±0.05            | 0.21% |
|             | C1005NP0409 | GTS          | C1005NP0409         | GT          | 1V, 1MHz | 4.0                 | pF               | ±0.25pF,±0.1pF,±0.05pF | 0.50   | ±0.05     | ±0.05            | 0.21% |
|             | C1005NP0439 | GTS          | C1005NP0439         | GT          | 1V, 1MHz | 4.3                 | pF               | ±0.25pF,±0.1pF,±0.05pF | 0.50   | ±0.05     | ±0.05            | 0.21% |
|             | C1005NP0479 | GTS          | C1005NP0479         | GT          | 1V, 1MHz | 4.7                 | pF               | ±0.25pF,±0.1pF,±0.05pF | 0.50   | ±0.05     | ±0.05            | 0.20% |
|             | C1005NP0509 | GTS          | C1005NP0509         | GT          | 1V, 1MHz | 5.0                 | pF               | ±0.5pF,±0.25pF,±0.1pF  | 0.50   | ±0.05     | ±0.05            | 0.20% |
|             | C1005NP0519 | GTS          | C1005NP0519         | GT          | 1V, 1MHz | 5.1                 | pF               | ±0.5pF,±0.25pF,±0.1pF  | 0.50   | ±0.05     | ±0.05            | 0.20% |
|             | C1005NP0569 | GTS          | C1005NP0569         | GT          | 1V, 1MHz | 5.6                 | pF               | ±0.5pF,±0.25pF,±0.1pF  | 0.50   | ±0.05     | ±0.05            | 0.20% |
|             | C1005NP0609 | GTS          | C1005NP0609         | GT          | 1V, 1MHz | 6.0                 | pF               | ±0.5pF,±0.25pF,±0.1pF  | 0.50   | ±0.05     | ±0.05            | 0.19% |
|             | C1005NP0629 | GTS          | C1005NP0629         | GT          | 1V, 1MHz | 6.2                 | pF               | ±0.5pF,±0.25pF,±0.1pF  | 0.50   | ±0.05     | ±0.05            | 0.19% |
|             | C1005NP0689 | GTS          | C1005NP0689         | GT          | 1V, 1MHz | 6.8                 | pF               | ±0.5pF,±0.25pF,±0.1pF  | 0.50   | ±0.05     | ±0.05            | 0.19% |
|             | C1005NP0709 | GTS          | C1005NP0709         | GT          | 1V, 1MHz | 7.0                 | pF               | ±0.5pF,±0.25pF,±0.1pF  | 0.50   | ±0.05     | ±0.05            | 0.19% |
|             | C1005NP0759 | GTS          | C1005NP0759         | GT          | 1V, 1MHz | 7.5                 | pF               | ±0.5pF,±0.25pF,±0.1pF  | 0.50   | ±0.05     | ±0.05            | 0.18% |
|             | C1005NP0809 | GTS          | C1005NP0809         | GT          | 1V, 1MHz | 8.0                 | pF               | ±0.5pF,±0.25pF,±0.1pF  | 0.50   | ±0.05     | ±0.05            | 0.18% |
|             | C1005NP0829 | GTS          | C1005NP0829         | GT          | 1V, 1MHz | 8.2                 | pF               | ±0.5pF,±0.25pF,±0.1pF  | 0.50   | ±0.05     | ±0.05            | 0.18% |
|             | C1005NP0909 | GTS          | C1005NP0909         | GT          | 1V, 1MHz | 9.0                 | pF               | ±0.5pF,±0.25pF,±0.1pF  | 0.50   | ±0.05     | ±0.05            | 0.17% |
|             | C1005NP0919 | GTS          | C1005NP0919         | GT          | 1V, 1MHz | 9.1                 | pF               | ±0.5pF,±0.25pF,±0.1pF  | 0.50   | ±0.05     | ±0.05            | 0.17% |
|             | C1005NP0100 | GTS          | C1005NP0100         | GT          | 1V, 1MHz | 10                  | pF               | ±5%,±2%,±1%            | 0.50   | ±0.05     | ±0.05            | 0.17% |
|             | C1005NP0110 | GTS          | C1005NP0110         | GT          | 1V, 1MHz | 11                  | pF               | ±5%,±2%,±1%            | 0.50   | ±0.05     | ±0.05            | 0.16% |
|             | C1005NP0120 | GTS          | C1005NP0120         | GT          | 1V, 1MHz | 12                  | pF               | ±5%,±2%,±1%            | 0.50   | ±0.05     | ±0.05            | 0.16% |
| C1005NP0150 | GTS         | C1005NP0150  | GT                  | 1V, 1MHz    | 15       | pF                  | ±5%,±2%,±1%      | 0.50                   | ±0.05  | ±0.05     | 0.14%            |       |
| C1005NP0160 | GTS         | C1005NP0160  | GT                  | 1V, 1MHz    | 16       | pF                  | ±5%,±2%,±1%      | 0.50                   | ±0.05  | ±0.05     | 0.14%            |       |
| C1005NP0180 | GTS         | C1005NP0180  | GT                  | 1V, 1MHz    | 18       | pF                  | ±5%,±2%,±1%      | 0.50                   | ±0.05  | ±0.05     | 0.13%            |       |
| C1005NP0200 | GTS         | C1005NP0200  | GT                  | 1V, 1MHz    | 20       | pF                  | ±5%,±2%,±1%      | 0.50                   | ±0.05  | ±0.05     | 0.13%            |       |
| C1005NP0220 | GTS         | C1005NP0220  | GT                  | 1V, 1MHz    | 22       | pF                  | ±5%,±2%,±1%      | 0.50                   | ±0.05  | ±0.05     | 0.12%            |       |
| C1005NP0240 | GTS         | C1005NP0240  | GT                  | 1V, 1MHz    | 24       | pF                  | ±5%,±2%,±1%      | 0.50                   | ±0.05  | ±0.05     | 0.11%            |       |
| C1005NP0270 | GTS         | C1005NP0270  | GT                  | 1V, 1MHz    | 27       | pF                  | ±5%,±2%,±1%      | 0.50                   | ±0.05  | ±0.05     | 0.11%            |       |
| C1005NP0300 | GTS         | C1005NP0300  | GT                  | 1V, 1MHz    | 30       | pF                  | ±5%,±2%,±1%      | 0.50                   | ±0.05  | ±0.05     | 0.10%            |       |
| C1005NP0330 | GTS         | C1005NP0330  | GT                  | 1V, 1MHz    | 33       | pF                  | ±10%,±5%,±2%,±1% | 0.50                   | ±0.05  | ±0.05     | 0.10%            |       |
| C1005NP0360 | GTS         | C1005NP0360  | GT                  | 1V, 1MHz    | 36       | pF                  | ±5%,±2%,±1%      | 0.50                   | ±0.05  | ±0.05     | 0.10%            |       |
| C1005NP0390 | GTS         | C1005NP0390  | GT                  | 1V, 1MHz    | 39       | pF                  | ±5%,±2%,±1%      | 0.50                   | ±0.05  | ±0.05     | 0.10%            |       |
| C1005NP0430 | GTS         | C1005NP0430  | GT                  | 1V, 1MHz    | 43       | pF                  | ±5%,±2%,±1%      | 0.50                   | ±0.05  | ±0.05     | 0.10%            |       |
| C1005NP0470 | GTS         | C1005NP0470  | GT                  | 1V, 1MHz    | 47       | pF                  | ±5%,±2%,±1%      | 0.50                   | ±0.05  | ±0.05     | 0.10%            |       |
| C1005NP0510 | GTS         | C1005NP0510  | GT                  | 1V, 1MHz    | 51       | pF                  | ±5%,±2%,±1%      | 0.50                   | ±0.05  | ±0.05     | 0.10%            |       |
| C1005NP0560 | GTS         | C1005NP0560  | GT                  | 1V, 1MHz    | 56       | pF                  | ±5%,±2%,±1%      | 0.50                   | ±0.05  | ±0.05     | 0.10%            |       |
| C1005NP0620 | GTS         | C1005NP0620  | GT                  | 1V, 1MHz    | 62       | pF                  | ±5%,±2%,±1%      | 0.50                   | ±0.05  | ±0.05     | 0.10%            |       |
| C1005NP0680 | GTS         | C1005NP0680  | GT                  | 1V, 1MHz    | 68       | pF                  | ±5%,±2%,±1%      | 0.50                   | ±0.05  | ±0.05     | 0.10%            |       |
| C1005NP0750 | GTS         | C1005NP0750  | GT                  | 1V, 1MHz    | 75       | pF                  | ±5%,±2%,±1%      | 0.50                   | ±0.05  | ±0.05     | 0.10%            |       |
| C1005NP0820 | GTS         | C1005NP0820  | GT                  | 1V, 1MHz    | 82       | pF                  | ±5%,±2%,±1%      | 0.50                   | ±0.05  | ±0.05     | 0.10%            |       |
| C1005NP0910 | GTS         | C1005NP0910  | GT                  | 1V, 1MHz    | 91       | pF                  | ±5%,±2%,±1%      | 0.50                   | ±0.05  | ±0.05     | 0.10%            |       |
| C1005NP0101 | GTS         | C1005NP0101  | GT                  | 1V, 1MHz    | 100      | pF                  | ±5%,±2%,±1%      | 0.50                   | ±0.05  | ±0.05     | 0.10%            |       |
| C1005NP0121 | GTS         | C1005NP0121  | GT                  | 1V, 1MHz    | 120      | pF                  | ±5%,±2%,±1%      | 0.50                   | ±0.05  | ±0.05     | 0.10%            |       |
| C1005NP0151 | GTS         | C1005NP0151  | GT                  | 1V, 1MHz    | 150      | pF                  | ±5%,±2%,±1%      | 0.50                   | ±0.05  | ±0.05     | 0.10%            |       |
| C1005NP0181 | GTS         | C1005NP0181  | GT                  | 1V, 1MHz    | 180      | pF                  | ±5%,±2%,±1%      | 0.50                   | ±0.05  | ±0.05     | 0.10%            |       |
| C1005NP0201 | GTS         | C1005NP0201  | GT                  | 1V, 1MHz    | 200      | pF                  | ±5%,±2%,±1%      | 0.50                   | ±0.05  | ±0.05     | 0.10%            |       |
| C1005NP0221 | GTS         | C1005NP0221  | GT                  | 1V, 1MHz    | 220      | pF                  | ±5%,±2%,±1%      | 0.50                   | ±0.05  | ±0.05     | 0.10%            |       |

Paper, 10Kpcs

□ Tolerance Code: A=±0.05 pF, B=±0.1pF, C=±0.25pF, D=±0.5pF, F=±1%, G=±2%, J=±5%; Special tolerance on the request.

| RV  | DARFON P/N       | DARFON P/N 2    | Measuring Condition | Capacitance |      | Available Tolerance    | Thick. (mm) | Tolerance(mm) |        | DF (max.) | Standard Packing |
|-----|------------------|-----------------|---------------------|-------------|------|------------------------|-------------|---------------|--------|-----------|------------------|
|     |                  |                 |                     | Value       | Unit |                        |             | L/W           | Thick. |           |                  |
| 50V | C1005NP0271 GTS  | C1005NP0271 GT  | 1V, 1MHz            | 270         | pF   | ±5%,±2%,±1%            | 0.50        | ±0.05         | ±0.05  | 0.10%     | Paper, 10Kpcs    |
|     | C1005NP0301 GTS  | C1005NP0301 GT  | 1V, 1MHz            | 300         | pF   | ±5%,±2%                | 0.50        | ±0.05         | ±0.05  | 0.10%     |                  |
|     | C1005NP0331 GTS  | C1005NP0331 GT  | 1V, 1MHz            | 330         | pF   | ±5%,±2%                | 0.50        | ±0.05         | ±0.05  | 0.10%     |                  |
|     | C1005NP0391 GTS  | C1005NP0391 GT  | 1V, 1MHz            | 390         | pF   | ±5%,±2%,±1%            | 0.50        | ±0.05         | ±0.05  | 0.10%     |                  |
|     | C1005NP0471 GTS  | C1005NP0471 GT  | 1V, 1MHz            | 470         | pF   | ±5%,±2%                | 0.50        | ±0.05         | ±0.05  | 0.10%     |                  |
|     | C1005NP0561 GTS  | C1005NP0561 GT  | 1V, 1MHz            | 560         | pF   | ±5%,±2%                | 0.50        | ±0.05         | ±0.05  | 0.10%     |                  |
|     | C1005NP0681 GTS  | C1005NP0681 GT  | 1V, 1MHz            | 680         | pF   | ±5%,±2%,±1%            | 0.50        | ±0.05         | ±0.05  | 0.10%     |                  |
|     | C1005NP0821 GTS  | C1005NP0821 GT  | 1V, 1MHz            | 820         | pF   | ±5%,±2%                | 0.50        | ±0.05         | ±0.05  | 0.10%     |                  |
| 25V | C1005NP0102 GTS  | C1005NP0102 GT  | 1V, 1MHz            | 1.0         | nF   | ±5%,±2%                | 0.50        | ±0.05         | ±0.05  | 0.10%     | Paper, 10Kpcs    |
|     | C1005NP0208 FTS  | C1005NP0208 FT  | 1V, 1MHz            | 0.2         | pF   | ±0.25pF,±0.1pF,±0.05pF | 0.50        | ±0.05         | ±0.05  | 0.25%     |                  |
|     | C1005NP0308 FTS  | C1005NP0308 FT  | 1V, 1MHz            | 0.3         | pF   | ±0.25pF,±0.1pF,±0.05pF | 0.50        | ±0.05         | ±0.05  | 0.25%     |                  |
|     | C1005NP0120 JFTS | C1005NP0120 JFT | 1V, 1MHz            | 12          | pF   | ±5%,±2%,±1%            | 0.50        | ±0.05         | ±0.05  | 0.16%     |                  |
|     | C1005NP0221 JFTS | C1005NP0221 JFT | 1V, 1MHz            | 220         | pF   | ±5%                    | 0.50        | ±0.05         | ±0.05  | 0.10%     |                  |
| 16V | C1005NP0102 JFTS | C1005NP0102 JFT | 1V, 1MHz            | 1.0         | nF   | ±5%                    | 0.50        | ±0.05         | ±0.05  | 0.10%     | Paper, 10Kpcs    |
|     | C1005NP0470 ETS  | C1005NP0470 ET  | 1V, 1MHz            | 47          | pF   | ±5%,±2%,±1%            | 0.50        | ±0.05         | ±0.05  | 0.10%     |                  |
| 10V | C1005NP0331 ETS  | C1005NP0331 ET  | 1V, 1MHz            | 330         | pF   | ±5%,±2%                | 0.50        | ±0.05         | ±0.05  | 0.10%     | Paper, 10Kpcs    |
|     | C1005NP0220 DTS  | C1005NP0220 DT  | 1V, 1MHz            | 22          | pF   | ±5%,±2%,±1%            | 0.50        | ±0.05         | ±0.05  | 0.12%     |                  |

● C1608NP0\_S Series (EIA0603)

| RV              | DARFON P/N      | DARFON P/N 2   | Measuring Condition | Capacitance |             | Available Tolerance    | Thick. (mm) | Tolerance(mm) |        | DF (max.) | Standard Packing |
|-----------------|-----------------|----------------|---------------------|-------------|-------------|------------------------|-------------|---------------|--------|-----------|------------------|
|                 |                 |                |                     | Value       | Unit        |                        |             | L/W           | Thick. |           |                  |
| 50V             | C1608NP0308 GTS | C1608NP0308 GT | 1V, 1MHz            | 0.30        | pF          | ±0.25pF,±0.1pF,±0.05pF | 0.80        | ±0.10         | ±0.10  | 0.25%     | Paper, 4Kpcs     |
|                 | C1608NP0508 GTS | C1608NP0508 GT | 1V, 1MHz            | 0.50        | pF          | ±0.25pF,±0.1pF,±0.05pF | 0.80        | ±0.10         | ±0.10  | 0.24%     |                  |
|                 | C1608NP0758 GTS | C1608NP0758 GT | 1V, 1MHz            | 0.75        | pF          | ±0.25pF,±0.1pF,±0.05pF | 0.80        | ±0.10         | ±0.10  | 0.24%     |                  |
|                 | C1608NP0109 GTS | C1608NP0109 GT | 1V, 1MHz            | 1.0         | pF          | ±0.25pF,±0.1pF         | 0.80        | ±0.10         | ±0.10  | 0.24%     |                  |
|                 | C1608NP0129 GTS | C1608NP0129 GT | 1V, 1MHz            | 1.2         | pF          | ±0.25pF,±0.1pF         | 0.80        | ±0.10         | ±0.10  | 0.24%     |                  |
|                 | C1608NP0159 GTS | C1608NP0159 GT | 1V, 1MHz            | 1.5         | pF          | ±0.25pF,±0.1pF         | 0.80        | ±0.10         | ±0.10  | 0.23%     |                  |
|                 | C1608NP0189 GTS | C1608NP0189 GT | 1V, 1MHz            | 1.8         | pF          | ±0.25pF,±0.1pF         | 0.80        | ±0.10         | ±0.10  | 0.23%     |                  |
|                 | C1608NP0209 GTS | C1608NP0209 GT | 1V, 1MHz            | 2.0         | pF          | ±0.25pF,±0.1pF         | 0.80        | ±0.10         | ±0.10  | 0.23%     |                  |
|                 | C1608NP0229 GTS | C1608NP0229 GT | 1V, 1MHz            | 2.2         | pF          | ±0.25pF,±0.1pF         | 0.80        | ±0.10         | ±0.10  | 0.23%     |                  |
|                 | C1608NP0249 GTS | C1608NP0249 GT | 1V, 1MHz            | 2.4         | pF          | ±0.25pF,±0.1pF         | 0.80        | ±0.10         | ±0.10  | 0.22%     |                  |
|                 | C1608NP0279 GTS | C1608NP0279 GT | 1V, 1MHz            | 2.7         | pF          | ±0.25pF,±0.1pF         | 0.80        | ±0.10         | ±0.10  | 0.22%     |                  |
|                 | C1608NP0309 GTS | C1608NP0309 GT | 1V, 1MHz            | 3.0         | pF          | ±0.25pF,±0.1pF         | 0.80        | ±0.10         | ±0.10  | 0.22%     |                  |
|                 | C1608NP0339 GTS | C1608NP0339 GT | 1V, 1MHz            | 3.3         | pF          | ±0.25pF,±0.1pF         | 0.80        | ±0.10         | ±0.10  | 0.21%     |                  |
|                 | C1608NP0399 GTS | C1608NP0399 GT | 1V, 1MHz            | 3.9         | pF          | ±0.25pF,±0.1pF         | 0.80        | ±0.10         | ±0.10  | 0.21%     |                  |
|                 | C1608NP0409 GTS | C1608NP0409 GT | 1V, 1MHz            | 4.0         | pF          | ±0.25pF,±0.1pF         | 0.80        | ±0.10         | ±0.10  | 0.21%     |                  |
|                 | C1608NP0479 GTS | C1608NP0479 GT | 1V, 1MHz            | 4.7         | pF          | ±0.25pF,±0.1pF         | 0.80        | ±0.10         | ±0.10  | 0.20%     |                  |
|                 | C1608NP0509 GTS | C1608NP0509 GT | 1V, 1MHz            | 5.0         | pF          | ±0.5pF,±0.25pF,±0.1pF  | 0.80        | ±0.10         | ±0.10  | 0.20%     |                  |
|                 | C1608NP0569 GTS | C1608NP0569 GT | 1V, 1MHz            | 5.6         | pF          | ±0.5pF,±0.25pF,±0.1pF  | 0.80        | ±0.10         | ±0.10  | 0.20%     |                  |
|                 | C1608NP0609 GTS | C1608NP0609 GT | 1V, 1MHz            | 6.0         | pF          | ±0.5pF,±0.25pF,±0.1pF  | 0.80        | ±0.10         | ±0.10  | 0.19%     |                  |
|                 | C1608NP0629 GTS | C1608NP0629 GT | 1V, 1MHz            | 6.2         | pF          | ±0.5pF,±0.25pF,±0.1pF  | 0.80        | ±0.10         | ±0.10  | 0.19%     |                  |
|                 | C1608NP0689 GTS | C1608NP0689 GT | 1V, 1MHz            | 6.8         | pF          | ±0.5pF,±0.25pF,±0.1pF  | 0.80        | ±0.10         | ±0.10  | 0.19%     |                  |
|                 | C1608NP0709 GTS | C1608NP0709 GT | 1V, 1MHz            | 7.0         | pF          | ±0.5pF,±0.25pF,±0.1pF  | 0.80        | ±0.10         | ±0.10  | 0.19%     |                  |
|                 | C1608NP0829 GTS | C1608NP0829 GT | 1V, 1MHz            | 8.2         | pF          | ±0.5pF,±0.25pF,±0.1pF  | 0.80        | ±0.10         | ±0.10  | 0.18%     |                  |
|                 | C1608NP0909 GTS | C1608NP0909 GT | 1V, 1MHz            | 9.0         | pF          | ±0.5pF,±0.25pF,±0.1pF  | 0.80        | ±0.10         | ±0.10  | 0.17%     |                  |
|                 | C1608NP0100 GTS | C1608NP0100 GT | 1V, 1MHz            | 10          | pF          | ±5%,±2%,±1%            | 0.80        | ±0.10         | ±0.10  | 0.17%     |                  |
|                 | C1608NP0110 GTS | C1608NP0110 GT | 1V, 1MHz            | 11          | pF          | ±5%,±2%,±1%            | 0.80        | ±0.10         | ±0.10  | 0.16%     |                  |
|                 | C1608NP0120 GTS | C1608NP0120 GT | 1V, 1MHz            | 12          | pF          | ±5%,±2%,±1%            | 0.80        | ±0.10         | ±0.10  | 0.16%     |                  |
|                 | C1608NP0150 GTS | C1608NP0150 GT | 1V, 1MHz            | 15          | pF          | ±5%,±2%,±1%            | 0.80        | ±0.10         | ±0.10  | 0.14%     |                  |
|                 | C1608NP0180 GTS | C1608NP0180 GT | 1V, 1MHz            | 18          | pF          | ±5%,±2%,±1%            | 0.80        | ±0.10         | ±0.10  | 0.13%     |                  |
|                 | C1608NP0200 GTS | C1608NP0200 GT | 1V, 1MHz            | 20          | pF          | ±5%,±2%,±1%            | 0.80        | ±0.10         | ±0.10  | 0.13%     |                  |
|                 | C1608NP0220 GTS | C1608NP0220 GT | 1V, 1MHz            | 22          | pF          | ±5%,±2%,±1%            | 0.80        | ±0.10         | ±0.10  | 0.12%     |                  |
|                 | C1608NP0240 GTS | C1608NP0240 GT | 1V, 1MHz            | 24          | pF          | ±5%,±2%,±1%            | 0.80        | ±0.10         | ±0.10  | 0.11%     |                  |
|                 | C1608NP0270 GTS | C1608NP0270 GT | 1V, 1MHz            | 27          | pF          | ±5%,±2%,±1%            | 0.80        | ±0.10         | ±0.10  | 0.11%     |                  |
|                 | C1608NP0300 GTS | C1608NP0300 GT | 1V, 1MHz            | 30          | pF          | ±5%,±2%,±1%            | 0.80        | ±0.10         | ±0.10  | 0.10%     |                  |
|                 | C1608NP0330 GTS | C1608NP0330 GT | 1V, 1MHz            | 33          | pF          | ±5%,±2%,±1%            | 0.80        | ±0.10         | ±0.10  | 0.10%     |                  |
|                 | C1608NP0360 GTS | C1608NP0360 GT | 1V, 1MHz            | 36          | pF          | ±5%,±2%,±1%            | 0.80        | ±0.10         | ±0.10  | 0.10%     |                  |
|                 | C1608NP0390 GTS | C1608NP0390 GT | 1V, 1MHz            | 39          | pF          | ±5%,±2%,±1%            | 0.80        | ±0.10         | ±0.10  | 0.10%     |                  |
|                 | C1608NP0430 GTS | C1608NP0430 GT | 1V, 1MHz            | 43          | pF          | ±5%,±2%,±1%            | 0.80        | ±0.10         | ±0.10  | 0.10%     |                  |
|                 | C1608NP0470 GTS | C1608NP0470 GT | 1V, 1MHz            | 47          | pF          | ±5%,±2%,±1%            | 0.80        | ±0.10         | ±0.10  | 0.10%     |                  |
|                 | C1608NP0560 GTS | C1608NP0560 GT | 1V, 1MHz            | 56          | pF          | ±5%,±2%,±1%            | 0.80        | ±0.10         | ±0.10  | 0.10%     |                  |
|                 | C1608NP0620 GTS | C1608NP0620 GT | 1V, 1MHz            | 62          | pF          | ±5%,±2%,±1%            | 0.80        | ±0.10         | ±0.10  | 0.10%     |                  |
|                 | C1608NP0680 GTS | C1608NP0680 GT | 1V, 1MHz            | 68          | pF          | ±5%,±2%,±1%            | 0.80        | ±0.10         | ±0.10  | 0.10%     |                  |
| C1608NP0750 GTS | C1608NP0750 GT  | 1V, 1MHz       | 75                  | pF          | ±5%,±2%,±1% | 0.80                   | ±0.10       | ±0.10         | 0.10%  |           |                  |
| C1608NP0820 GTS | C1608NP0820 GT  | 1V, 1MHz       | 82                  | pF          | ±5%,±2%,±1% | 0.80                   | ±0.10       | ±0.10         | 0.10%  |           |                  |
| C1608NP0910 GTS | C1608NP0910 GT  | 1V, 1MHz       | 91                  | pF          | ±5%,±2%,±1% | 0.80                   | ±0.10       | ±0.10         | 0.10%  |           |                  |
| C1608NP0101 GTS | C1608NP0101 GT  | 1V, 1MHz       | 100                 | pF          | ±5%,±2%,±1% | 0.80                   | ±0.10       | ±0.10         | 0.10%  |           |                  |
| C1608NP0121 GTS | C1608NP0121 GT  | 1V, 1MHz       | 120                 | pF          | ±5%,±2%,±1% | 0.80                   | ±0.10       | ±0.10         | 0.10%  |           |                  |
| C1608NP0151 GTS | C1608NP0151 GT  | 1V, 1MHz       | 150                 | pF          | ±5%,±2%,±1% | 0.80                   | ±0.10       | ±0.10         | 0.10%  |           |                  |
| C1608NP0181 GTS | C1608NP0181 GT  | 1V, 1MHz       | 180                 | pF          | ±5%,±2%,±1% | 0.80                   | ±0.10       | ±0.10         | 0.10%  |           |                  |
| C1608NP0201 GTS | C1608NP0201 GT  | 1V, 1MHz       | 200                 | pF          | ±5%,±2%,±1% | 0.80                   | ±0.10       | ±0.10         | 0.10%  |           |                  |
| C1608NP0221 GTS | C1608NP0221 GT  | 1V, 1MHz       | 220                 | pF          | ±5%,±2%,±1% | 0.80                   | ±0.10       | ±0.10         | 0.10%  |           |                  |



| RV              | DARFON P/N      | DARFON P/N 2   | Measuring Condition | Capacitance |      | Available Tolerance | Thick. (mm) | Tolerance(mm) |             | DF (max.) | Standard Packing |
|-----------------|-----------------|----------------|---------------------|-------------|------|---------------------|-------------|---------------|-------------|-----------|------------------|
|                 |                 |                |                     | Value       | Unit |                     |             | L/W           | Thick.      |           |                  |
| 50V             | C1608NP0271□GTS | C1608NP0271□GT | 1V, 1MHz            | 270         | pF   | ±5%,±2%             | 0.80        | ±0.10         | ±0.10       | 0.10%     | Paper, 4Kpcs     |
|                 | C1608NP0331□GTS | C1608NP0331□GT | 1V, 1MHz            | 330         | pF   | ±5%,±2%             | 0.80        | ±0.10         | ±0.10       | 0.10%     |                  |
|                 | C1608NP0391□GTS | C1608NP0391□GT | 1V, 1MHz            | 390         | pF   | ±5%,±2%             | 0.80        | ±0.10         | ±0.10       | 0.10%     |                  |
|                 | C1608NP0471□GTS | C1608NP0471□GT | 1V, 1MHz            | 470         | pF   | ±5%,±2%             | 0.80        | ±0.10         | ±0.10       | 0.10%     |                  |
|                 | C1608NP0561□GTS | C1608NP0561□GT | 1V, 1MHz            | 560         | pF   | ±5%,±2%             | 0.80        | ±0.10         | ±0.10       | 0.10%     |                  |
|                 | C1608NP0681□GTS | C1608NP0681□GT | 1V, 1MHz            | 680         | pF   | ±5%,±2%             | 0.80        | ±0.10         | ±0.10       | 0.10%     |                  |
|                 | C1608NP0821□GTS | C1608NP0821□GT | 1V, 1MHz            | 820         | pF   | ±5%,±2%             | 0.80        | ±0.10         | ±0.10       | 0.10%     |                  |
|                 | C1608NP0102□GTS | C1608NP0102□GT | 1V, 1MHz            | 1.0         | nF   | ±5%,±2%             | 0.80        | ±0.10         | ±0.10       | 0.10%     |                  |
|                 | C1608NP0122JGTS | C1608NP0122JGT | 1V, 1kHz            | 1.2         | nF   | ±5%                 | 0.80        | +0.15/-0.10   | +0.15/-0.10 | 0.10%     |                  |
|                 | C1608NP0152JGTS | C1608NP0152JGT | 1V, 1kHz            | 1.5         | nF   | ±5%                 | 0.80        | +0.15/-0.10   | +0.15/-0.10 | 0.10%     |                  |
|                 | C1608NP0182JGTS | C1608NP0182JGT | 1V, 1kHz            | 1.8         | nF   | ±5%                 | 0.80        | +0.15/-0.10   | +0.15/-0.10 | 0.10%     |                  |
|                 | C1608NP0222JGTS | C1608NP0222JGT | 1V, 1kHz            | 2.2         | nF   | ±5%                 | 0.80        | +0.15/-0.10   | +0.15/-0.10 | 0.10%     |                  |
| C1608NP0272JGTS | C1608NP0272JGT  | 1V, 1kHz       | 2.7                 | nF          | ±5%  | 0.80                | +0.15/-0.10 | +0.15/-0.10   | 0.10%       |           |                  |
| C1608NP0332JGTS | C1608NP0332JGT  | 1V, 1kHz       | 3.3                 | nF          | ±5%  | 0.80                | +0.15/-0.10 | +0.15/-0.10   | 0.10%       |           |                  |
| C1608NP0103JGTS | C1608NP0103JGT  | 1V, 1kHz       | 10                  | nF          | ±5%  | 0.80                | +0.15/-0.10 | +0.15/-0.10   | 0.10%       |           |                  |
| 25V             | C1608NP0152JFTS | C1608NP0152JFT | 1V, 1kHz            | 1.5         | nF   | ±5%                 | 0.80        | +0.15/-0.10   | +0.15/-0.10 | 0.10%     | Paper, 4Kpcs     |
|                 | C1608NP0682JFTS | C1608NP0682JFT | 1V, 1kHz            | 6.8         | nF   | ±5%                 | 0.80        | +0.15/-0.10   | +0.15/-0.10 | 0.10%     |                  |
|                 | C1608NP0103JFTS | C1608NP0103JFT | 1V, 1kHz            | 10          | nF   | ±5%                 | 0.80        | +0.15/-0.10   | +0.15/-0.10 | 0.10%     |                  |
| 16V             | C1608NP0180□ETS | C1608NP0180□ET | 1V, 1MHz            | 18          | pF   | ±5%,±2%,±1%         | 0.80        | ±0.10         | ±0.10       | 0.13%     | Paper, 4Kpcs     |
|                 | C1608NP0300JETS | C1608NP0300JET | 1V, 1MHz            | 30          | pF   | ±5%                 | 0.80        | ±0.10         | ±0.10       | 0.10%     |                  |
|                 | C1608NP0152JETS | C1608NP0152JET | 1V, 1kHz            | 1.5         | nF   | ±5%                 | 0.80        | +0.15/-0.10   | +0.15/-0.10 | 0.10%     |                  |
|                 | C1608NP0272JETS | C1608NP0272JET | 1V, 1kHz            | 2.7         | nF   | ±5%                 | 0.80        | +0.15/-0.10   | +0.15/-0.10 | 0.10%     |                  |
| C1608NP0332JETS | C1608NP0332JET  | 1V, 1kHz       | 3.3                 | nF          | ±5%  | 0.80                | +0.15/-0.10 | +0.15/-0.10   | 0.10%       |           |                  |

● C2012NP0\_S Series (EIA0805)

| RV              | DARFON P/N      | DARFON P/N 2   | Measuring Condition | Capacitance |      | Available Tolerance | Thick. (mm) | Tolerance(mm) |        | DF (max.) | Standard Packing |
|-----------------|-----------------|----------------|---------------------|-------------|------|---------------------|-------------|---------------|--------|-----------|------------------|
|                 |                 |                |                     | Value       | Unit |                     |             | L/W           | Thick. |           |                  |
| 50V             | C2012NP0100□GTS | C2012NP0100□GT | 1V, 1MHz            | 10          | pF   | ±5%,±2%             | 0.60        | ±0.15         | ±0.15  | 0.17%     | Paper, 4Kpcs     |
|                 | C2012NP0120□GTS | C2012NP0120□GT | 1V, 1MHz            | 12          | pF   | ±5%,±2%             | 0.60        | ±0.15         | ±0.15  | 0.16%     |                  |
|                 | C2012NP0150□GTS | C2012NP0150□GT | 1V, 1MHz            | 15          | pF   | ±5%,±2%             | 0.60        | ±0.15         | ±0.15  | 0.14%     |                  |
|                 | C2012NP0180□GTS | C2012NP0180□GT | 1V, 1MHz            | 18          | pF   | ±5%,±2%             | 0.60        | ±0.15         | ±0.15  | 0.13%     |                  |
|                 | C2012NP0200□GTS | C2012NP0200□GT | 1V, 1MHz            | 20          | pF   | ±5%,±2%             | 0.60        | ±0.15         | ±0.15  | 0.13%     |                  |
|                 | C2012NP0220□GTS | C2012NP0220□GT | 1V, 1MHz            | 22          | pF   | ±5%,±2%             | 0.60        | ±0.15         | ±0.15  | 0.12%     |                  |
|                 | C2012NP0270□GTS | C2012NP0270□GT | 1V, 1MHz            | 27          | pF   | ±5%,±2%             | 0.60        | ±0.15         | ±0.15  | 0.11%     |                  |
|                 | C2012NP0300□GTS | C2012NP0300□GT | 1V, 1MHz            | 30          | pF   | ±5%,±2%             | 0.60        | ±0.15         | ±0.15  | 0.10%     |                  |
|                 | C2012NP0330□GTS | C2012NP0330□GT | 1V, 1MHz            | 33          | pF   | ±5%,±2%             | 0.60        | ±0.15         | ±0.15  | 0.10%     |                  |
|                 | C2012NP0360□GTS | C2012NP0360□GT | 1V, 1MHz            | 36          | pF   | ±5%,±2%             | 0.60        | ±0.15         | ±0.15  | 0.10%     |                  |
|                 | C2012NP0470□GTS | C2012NP0470□GT | 1V, 1MHz            | 47          | pF   | ±5%,±2%             | 0.60        | ±0.15         | ±0.15  | 0.10%     |                  |
|                 | C2012NP0680□GTS | C2012NP0680□GT | 1V, 1MHz            | 68          | pF   | ±5%,±2%             | 0.60        | ±0.15         | ±0.15  | 0.10%     |                  |
|                 | C2012NP0820□GTS | C2012NP0820□GT | 1V, 1MHz            | 82          | pF   | ±5%,±2%             | 0.60        | ±0.15         | ±0.15  | 0.10%     |                  |
|                 | C2012NP0101□GTS | C2012NP0101□GT | 1V, 1MHz            | 100         | pF   | ±5%,±2%             | 0.60        | ±0.15         | ±0.15  | 0.10%     |                  |
|                 | C2012NP0121JGTS | C2012NP0121JGT | 1V, 1MHz            | 120         | pF   | ±5%                 | 0.60        | ±0.15         | ±0.15  | 0.10%     |                  |
|                 | C2012NP0151JGTS | C2012NP0151JGT | 1V, 1MHz            | 150         | pF   | ±5%                 | 0.60        | ±0.15         | ±0.15  | 0.10%     |                  |
|                 | C2012NP0201JGTS | C2012NP0201JGT | 1V, 1MHz            | 200         | pF   | ±5%                 | 0.60        | ±0.15         | ±0.15  | 0.10%     |                  |
|                 | C2012NP0221JGTS | C2012NP0221JGT | 1V, 1MHz            | 220         | pF   | ±5%                 | 0.60        | ±0.15         | ±0.15  | 0.10%     |                  |
|                 | C2012NP0271JGTS | C2012NP0271JGT | 1V, 1MHz            | 270         | pF   | ±5%                 | 0.60        | ±0.15         | ±0.15  | 0.10%     |                  |
|                 | C2012NP0331JGTS | C2012NP0331JGT | 1V, 1MHz            | 330         | pF   | ±5%                 | 0.60        | ±0.15         | ±0.15  | 0.10%     |                  |
|                 | C2012NP0391JGTS | C2012NP0391JGT | 1V, 1MHz            | 390         | pF   | ±5%                 | 0.60        | ±0.15         | ±0.15  | 0.10%     |                  |
|                 | C2012NP0471JGTS | C2012NP0471JGT | 1V, 1MHz            | 470         | pF   | ±5%                 | 0.60        | ±0.15         | ±0.15  | 0.10%     |                  |
|                 | C2012NP0561JGTS | C2012NP0561JGT | 1V, 1MHz            | 560         | pF   | ±5%                 | 0.60        | ±0.15         | ±0.15  | 0.10%     |                  |
|                 | C2012NP0681JGTS | C2012NP0681JGT | 1V, 1MHz            | 680         | pF   | ±5%                 | 0.60        | ±0.15         | ±0.15  | 0.10%     |                  |
|                 | C2012NP0821JGTS | C2012NP0821JGT | 1V, 1MHz            | 820         | pF   | ±5%                 | 0.60        | ±0.15         | ±0.15  | 0.10%     |                  |
|                 | C2012NP0102JGTS | C2012NP0102JGT | 1V, 1MHz            | 1.0         | nF   | ±5%                 | 0.60        | ±0.15         | ±0.15  | 0.10%     |                  |
|                 | C2012NP0122JGTS | C2012NP0122JGT | 1V, 1kHz            | 1.2         | nF   | ±5%                 | 0.85        | ±0.15         | ±0.15  | 0.10%     |                  |
|                 | C2012NP0152JGTS | C2012NP0152JGT | 1V, 1kHz            | 1.5         | nF   | ±5%                 | 0.85        | ±0.15         | ±0.15  | 0.10%     |                  |
|                 | C2012NP0182JGTS | C2012NP0182JGT | 1V, 1kHz            | 1.8         | nF   | ±5%                 | 0.85        | ±0.15         | ±0.15  | 0.10%     |                  |
|                 | C2012NP0222JGTS | C2012NP0222JGT | 1V, 1kHz            | 2.2         | nF   | ±5%                 | 0.85        | ±0.15         | ±0.15  | 0.10%     |                  |
|                 | C2012NP0272JGTS | C2012NP0272JGT | 1V, 1kHz            | 2.7         | nF   | ±5%                 | 0.85        | ±0.15         | ±0.15  | 0.10%     |                  |
|                 | C2012NP0332JGTS | C2012NP0332JGT | 1V, 1kHz            | 3.3         | nF   | ±5%                 | 0.85        | ±0.15         | ±0.15  | 0.10%     |                  |
|                 | C2012NP0392JGTS | C2012NP0392JGT | 1V, 1kHz            | 3.9         | nF   | ±5%                 | 0.85        | ±0.15         | ±0.15  | 0.10%     |                  |
|                 | C2012NP0472JGTS | C2012NP0472JGT | 1V, 1kHz            | 4.7         | nF   | ±5%                 | 0.85        | ±0.15         | ±0.15  | 0.10%     |                  |
|                 | C2012NP0272JGPS | C2012NP0272JGP | 1V, 1kHz            | 2.7         | nF   | ±5%                 | 1.25        | ±0.15         | ±0.20  | 0.10%     |                  |
|                 | C2012NP0332JGPS | C2012NP0332JGP | 1V, 1kHz            | 3.3         | nF   | ±5%                 | 1.25        | ±0.15         | ±0.20  | 0.10%     |                  |
|                 | C2012NP0392JGPS | C2012NP0392JGP | 1V, 1kHz            | 3.9         | nF   | ±5%                 | 1.25        | ±0.15         | ±0.20  | 0.10%     |                  |
|                 | C2012NP0472JGPS | C2012NP0472JGP | 1V, 1kHz            | 4.7         | nF   | ±5%                 | 1.25        | ±0.15         | ±0.20  | 0.10%     |                  |
|                 | C2012NP0562JGPS | C2012NP0562JGP | 1V, 1kHz            | 5.6         | nF   | ±5%                 | 1.25        | ±0.15         | ±0.20  | 0.10%     |                  |
|                 | C2012NP0682JGPS | C2012NP0682JGP | 1V, 1kHz            | 6.8         | nF   | ±5%                 | 1.25        | ±0.15         | ±0.20  | 0.10%     |                  |
|                 | C2012NP0822JGPS | C2012NP0822JGP | 1V, 1kHz            | 8.2         | nF   | ±5%                 | 1.25        | ±0.15         | ±0.20  | 0.10%     |                  |
|                 | C2012NP0103JGTS | C2012NP0103JGT | 1V, 1kHz            | 10          | nF   | ±5%                 | 0.85        | ±0.15         | ±0.10  | 0.10%     |                  |
| C2012NP0103JGPS | C2012NP0103JGP  | 1V, 1kHz       | 10                  | nF          | ±5%  | 1.25                | ±0.15       | ±0.20         | 0.10%  |           |                  |
| 16V             | C2012NP0270□ETS | C2012NP0270□GT | 1V, 1MHz            | 27          | pF   | ±5%,±2%             | 0.60        | ±0.15         | ±0.15  | 0.11%     | Paper, 4Kpcs     |

□ Tolerance Code: F=±1%, G=±2%, J=±5%; Special tolerance on the request.



● C3216NP0\_S Series (EIA1206)

| RV              | DARFON P/N      | DARFON P/N 2   | Measuring Condition | Capacitance |      | Available Tolerance | Thick. (mm) | Tolerance(mm) |        | DF (max.)       | Standard Packing |
|-----------------|-----------------|----------------|---------------------|-------------|------|---------------------|-------------|---------------|--------|-----------------|------------------|
|                 |                 |                |                     | Value       | Unit |                     |             | L/W           | Thick. |                 |                  |
| 50V             | C3216NP0103JGPS | C3216NP0103JGP | 1V, 1kHz            | 10          | nF   | ±5%                 | 1.25        | ±0.15         | ±0.20  | 0.10%           | Embossed, 3Kpcs  |
|                 | C3216NP0123JGPS | C3216NP0123JGP | 1V, 1kHz            | 12          | nF   | ±5%                 | 1.60        | ±0.30         | ±0.30  | 0.10%           |                  |
|                 | C3216NP0153JGPS | C3216NP0153JGP | 1V, 1kHz            | 15          | nF   | ±5%                 | 1.60        | ±0.30         | ±0.30  | 0.10%           |                  |
|                 | C3216NP0183JGPS | C3216NP0183JGP | 1V, 1kHz            | 18          | nF   | ±5%                 | 1.60        | ±0.30         | ±0.30  | 0.10%           | Embossed, 2Kpcs  |
|                 | C3216NP0223JGPS | C3216NP0223JGP | 1V, 1kHz            | 22          | nF   | ±5%                 | 1.60        | ±0.30         | ±0.30  | 0.10%           |                  |
|                 | C3216NP0273JGPS | C3216NP0273JGP | 1V, 1kHz            | 27          | nF   | ±5%                 | 1.60        | ±0.30         | ±0.30  | 0.10%           |                  |
|                 | C3216NP0333JGPS | C3216NP0333JGP | 1V, 1kHz            | 33          | nF   | ±5%                 | 1.60        | ±0.30         | ±0.30  | 0.10%           |                  |
|                 | C3216NP0393JGPS | C3216NP0393JGP | 1V, 1kHz            | 39          | nF   | ±5%                 | 1.60        | ±0.30         | ±0.30  | 0.10%           |                  |
|                 | C3216NP0473JGPS | C3216NP0473JGP | 1V, 1kHz            | 47          | nF   | ±5%                 | 1.15        | ±0.20         | ±0.20  | 0.10%           |                  |
| C3216NP0104JGPS | C3216NP0104JGP  | 1V, 1kHz       | 100                 | nF          | ±5%  | 1.60                | ±0.30       | ±0.30         | 0.10%  | Embossed, 2Kpcs |                  |
| 16V             | C3216NP0123JEPS | C3216NP0123JEP | 1V, 1kHz            | 12          | nF   | ±5%                 | 1.60        | ±0.30         | ±0.30  | 0.10%           | Embossed, 2Kpcs  |
|                 | C3216NP0153JEPS | C3216NP0153JEP | 1V, 1kHz            | 15          | nF   | ±5%                 | 1.60        | ±0.30         | ±0.30  | 0.10%           |                  |
|                 | C3216NP0183JEPS | C3216NP0183JEP | 1V, 1kHz            | 18          | nF   | ±5%                 | 1.60        | ±0.30         | ±0.30  | 0.10%           |                  |
|                 | C3216NP0223JEPS | C3216NP0223JEP | 1V, 1kHz            | 22          | nF   | ±5%                 | 1.60        | ±0.30         | ±0.30  | 0.10%           |                  |
|                 | C3216NP0273JEPS | C3216NP0273JEP | 1V, 1kHz            | 27          | nF   | ±5%                 | 1.60        | ±0.30         | ±0.30  | 0.10%           |                  |
|                 | C3216NP0333JEPS | C3216NP0333JEP | 1V, 1kHz            | 33          | nF   | ±5%                 | 1.60        | ±0.30         | ±0.30  | 0.10%           |                  |
|                 | C3216NP0393JEPS | C3216NP0393JEP | 1V, 1kHz            | 39          | nF   | ±5%                 | 1.60        | ±0.30         | ±0.30  | 0.10%           |                  |

□ Tolerance Code: F=±1%, G=±2%, J=±5%; Special tolerance on the request.

## ● Class II: High Dielectric Constant Type

### ■ Feature

1. High volumetric efficiency
2. High insulation resistance
3. RoHS compliant
4. Halogen Free

### ■ Application

1. Blocking
2. Coupling
3. Timing
4. Bypassing
5. Frequency discriminating
6. Flittering

### ■ Part Number & Characteristic

#### ■ X5R Series

#### ● C0603X5R Series(EIA0201)

| RV              | DARFON P/N      | DARFON P/N 2   | Measuring Condition | Capacitance |      | Available Tolerance | Thick. (mm) | Tolerance(mm) |        | DF (max.) | Standard Packing | Test Spec. |
|-----------------|-----------------|----------------|---------------------|-------------|------|---------------------|-------------|---------------|--------|-----------|------------------|------------|
|                 |                 |                |                     | Value       | Unit |                     |             | L/W           | Thick. |           |                  |            |
| 50V             | C0603X5R102□GTS | C0603X5R102□GT | 1V, 1kHz            | 1.0         | nF   | ±10%, ±20%          | 0.30        | ±0.03         | ±0.03  | 5.0%      | Paper, 15Kpcs    | (I)        |
|                 | C0603X5R151KFST | C0603X5R151KFT | 1V, 1kHz            | 150         | pF   | ±10%                | 0.30        | ±0.03         | ±0.03  | 5.0%      | Paper, 15Kpcs    | (I)        |
|                 | C0603X5R102□FTS | C0603X5R102□FT | 1V, 1kHz            | 1.0         | nF   | ±10%, ±20%          | 0.30        | ±0.03         | ±0.03  | 5.0%      |                  | (I)        |
|                 | C0603X5R103□FTS | C0603X5R103□FT | 1V, 1kHz            | 10          | nF   | ±10%, ±20%          | 0.30        | ±0.03         | ±0.03  | 5.0%      |                  | (II)*      |
|                 | C0603X5R223□FTS | C0603X5R223□FT | 1V, 1kHz            | 22          | nF   | ±10%, ±20%          | 0.30        | ±0.03         | ±0.03  | 7.5%      |                  | (II)*      |
|                 | C0603X5R104□FTS | C0603X5R104□FT | 1V, 1kHz            | 100         | nF   | ±10%, ±20%          | 0.30        | ±0.03         | ±0.03  | 10.0%     |                  | (II)       |
| C0603X5R474MFTS | C0603X5R474MFT  | 1V, 1kHz       | 470                 | nF          | ±20% | 0.30                | ±0.09       | ±0.09         | 10.0%  | (II)*     |                  |            |
| 16V             | C0603X5R103□ETS | C0603X5R103□ET | 1V, 1kHz            | 10          | nF   | ±10%, ±20%          | 0.30        | ±0.03         | ±0.03  | 5.0%      | Paper, 15Kpcs    | (II)       |
|                 | C0603X5R223□ETS | C0603X5R223□ET | 1V, 1kHz            | 22          | nF   | ±10%, ±20%          | 0.30        | ±0.03         | ±0.03  | 10.0%     |                  | (II)*      |
|                 | C0603X5R473□ETS | C0603X5R473□ET | 1V, 1kHz            | 47          | nF   | ±10%, ±20%          | 0.30        | ±0.03         | ±0.03  | 10.0%     |                  | (II)       |
|                 | C0603X5R104□ETS | C0603X5R104□ET | 1V, 1kHz            | 100         | nF   | ±10%, ±20%          | 0.30        | ±0.03         | ±0.03  | 10.0%     |                  | (II)       |
|                 | C0603X5R224□ETS | C0603X5R224□ET | 1V, 1kHz            | 220         | nF   | ±10%, ±20%          | 0.30        | ±0.03         | ±0.03  | 10.0%     |                  | (II)       |
|                 | C0603X5R105MET  | C0603X5R105MET | 0.5V, 1kHz          | 1.0         | uF   | ±20%                | 0.30        | ±0.09         | ±0.09  | 12.5%     |                  | (II)*      |
| 10V             | C0603X5R222□DTS | C0603X5R222□DT | 1V, 1kHz            | 2.2         | nF   | ±10%, ±20%          | 0.30        | ±0.03         | ±0.03  | 7.5%      | Paper, 15Kpcs    | (I)        |
|                 | C0603X5R332□DTS | C0603X5R332□DT | 1V, 1kHz            | 3.3         | nF   | ±10%, ±20%          | 0.30        | ±0.03         | ±0.03  | 7.5%      |                  | (I)        |
|                 | C0603X5R472□DTS | C0603X5R472□DT | 1V, 1kHz            | 4.7         | nF   | ±10%, ±20%          | 0.30        | ±0.03         | ±0.03  | 7.5%      |                  | (I)        |
|                 | C0603X5R562□DTS | C0603X5R562□DT | 1V, 1kHz            | 5.6         | nF   | ±10%, ±20%          | 0.30        | ±0.03         | ±0.03  | 7.5%      |                  | (I)        |
|                 | C0603X5R682□DTS | C0603X5R682□DT | 1V, 1kHz            | 6.8         | nF   | ±10%, ±20%          | 0.30        | ±0.03         | ±0.03  | 7.5%      |                  | (I)        |
|                 | C0603X5R822□DTS | C0603X5R822□DT | 1V, 1kHz            | 8.2         | nF   | ±10%, ±20%          | 0.30        | ±0.03         | ±0.03  | 7.5%      |                  | (I)        |
|                 | C0603X5R103□DTS | C0603X5R103□DT | 1V, 1kHz            | 10          | nF   | ±10%, ±20%          | 0.30        | ±0.03         | ±0.03  | 7.5%      |                  | (I)        |
|                 | C0603X5R153□DTS | C0603X5R153□DT | 1V, 1kHz            | 15          | nF   | ±10%, ±20%          | 0.30        | ±0.03         | ±0.03  | 7.5%      |                  | (II)       |
|                 | C0603X5R223□DTS | C0603X5R223□DT | 1V, 1kHz            | 22          | nF   | ±10%, ±20%          | 0.30        | ±0.03         | ±0.03  | 10.0%     |                  | (II)       |
|                 | C0603X5R333□DTS | C0603X5R333□DT | 1V, 1kHz            | 33          | nF   | ±10%, ±20%          | 0.30        | ±0.03         | ±0.03  | 10.0%     |                  | (II)       |
|                 | C0603X5R473□DTS | C0603X5R473□DT | 1V, 1kHz            | 47          | nF   | ±10%, ±20%          | 0.30        | ±0.03         | ±0.03  | 10.0%     |                  | (II)       |
|                 | C0603X5R563□DTS | C0603X5R563□DT | 1V, 1kHz            | 56          | nF   | ±10%, ±20%          | 0.30        | ±0.03         | ±0.03  | 10.0%     |                  | (II)       |
|                 | C0603X5R683□DTS | C0603X5R683□DT | 1V, 1kHz            | 68          | nF   | ±10%, ±20%          | 0.30        | ±0.03         | ±0.03  | 10.0%     |                  | (II)       |
|                 | C0603X5R823□DTS | C0603X5R823□DT | 1V, 1kHz            | 82          | nF   | ±10%, ±20%          | 0.30        | ±0.03         | ±0.03  | 10.0%     |                  | (II)       |
|                 | C0603X5R104□DTS | C0603X5R104□DT | 0.5V, 1kHz          | 100         | nF   | ±10%, ±20%          | 0.30        | ±0.03         | ±0.03  | 10.0%     |                  | (II)       |
|                 | C0603X5R224□DTS | C0603X5R224□DT | 0.5V, 1kHz          | 220         | nF   | ±10%, ±20%          | 0.30        | ±0.03         | ±0.03  | 10.0%     |                  | (II)*      |
|                 | C0603X5R474□DTS | C0603X5R474□DT | 0.5V, 1kHz          | 470         | nF   | ±10%, ±20%          | 0.30        | ±0.03         | ±0.03  | 12.5%     |                  | (II)*      |
|                 | C0603X5R105MDTS | C0603X5R105MDT | 0.5V, 1kHz          | 1.0         | uF   | ±20%                | 0.30        | ±0.09         | ±0.09  | 12.5%     |                  | (II)*      |
| 6.3V            | C0603X5R222□CTS | C0603X5R222□CT | 1V, 1kHz            | 2.2         | nF   | ±10%, ±20%          | 0.30        | ±0.03         | ±0.03  | 10.0%     | Paper, 15Kpcs    | (I)        |
|                 | C0603X5R332□CTS | C0603X5R332□CT | 1V, 1kHz            | 3.3         | nF   | ±10%, ±20%          | 0.30        | ±0.03         | ±0.03  | 10.0%     |                  | (I)        |
|                 | C0603X5R472□CTS | C0603X5R472□CT | 1V, 1kHz            | 4.7         | nF   | ±10%, ±20%          | 0.30        | ±0.03         | ±0.03  | 10.0%     |                  | (I)        |
|                 | C0603X5R562□CTS | C0603X5R562□CT | 1V, 1kHz            | 5.6         | nF   | ±10%, ±20%          | 0.30        | ±0.03         | ±0.03  | 10.0%     |                  | (I)        |
|                 | C0603X5R682□CTS | C0603X5R682□CT | 1V, 1kHz            | 6.8         | nF   | ±10%, ±20%          | 0.30        | ±0.03         | ±0.03  | 10.0%     |                  | (I)        |
|                 | C0603X5R822□CTS | C0603X5R822□CT | 1V, 1kHz            | 8.2         | nF   | ±10%, ±20%          | 0.30        | ±0.03         | ±0.03  | 10.0%     |                  | (I)        |
|                 | C0603X5R103□CTS | C0603X5R103□CT | 1V, 1kHz            | 10          | nF   | ±10%, ±20%          | 0.30        | ±0.03         | ±0.03  | 10.0%     |                  | (I)        |
|                 | C0603X5R223□CTS | C0603X5R223□CT | 1V, 1kHz            | 22          | nF   | ±10%, ±20%          | 0.30        | ±0.03         | ±0.03  | 10.0%     |                  | (II)       |
|                 | C0603X5R333□CTS | C0603X5R333□CT | 1V, 1kHz            | 33          | nF   | ±10%, ±20%          | 0.30        | ±0.03         | ±0.03  | 10.0%     |                  | (II)       |
|                 | C0603X5R473□CTS | C0603X5R473□CT | 1V, 1kHz            | 47          | nF   | ±10%, ±20%          | 0.30        | ±0.03         | ±0.03  | 10.0%     |                  | (II)       |
|                 | C0603X5R563□CTS | C0603X5R563□CT | 1V, 1kHz            | 56          | nF   | ±10%, ±20%          | 0.30        | ±0.03         | ±0.03  | 10.0%     |                  | (II)       |
|                 | C0603X5R683□CTS | C0603X5R683□CT | 1V, 1kHz            | 68          | nF   | ±10%, ±20%          | 0.30        | ±0.03         | ±0.03  | 10.0%     |                  | (II)       |
|                 | C0603X5R823□CTS | C0603X5R823□CT | 1V, 1kHz            | 82          | nF   | ±10%, ±20%          | 0.30        | ±0.03         | ±0.03  | 10.0%     |                  | (II)       |
|                 | C0603X5R104□CTS | C0603X5R104□CT | 0.5V, 1kHz          | 100         | nF   | ±10%, ±20%          | 0.30        | ±0.03         | ±0.03  | 10.0%     |                  | (II)       |
|                 | C0603X5R224□CTS | C0603X5R224□CT | 0.5V, 1kHz          | 220         | nF   | ±10%, ±20%          | 0.30        | ±0.03         | ±0.03  | 10.0%     |                  | (II)*      |
|                 | C0603X5R334□CTS | C0603X5R334□CT | 0.5V, 1kHz          | 330         | nF   | ±10%, ±20%          | 0.30        | ±0.03         | ±0.03  | 10.0%     |                  | (II)*      |
|                 | C0603X5R474□CTS | C0603X5R474□CT | 0.5V, 1kHz          | 470         | nF   | ±10%, ±20%          | 0.30        | ±0.03         | ±0.03  | 12.5%     |                  | (II)*      |
|                 | C0603X5R105□CTS | C0603X5R105□CT | 0.5V, 1kHz          | 1.0         | uF   | ±10%, ±20%          | 0.30        | ±0.05         | ±0.05  | 12.5%     |                  | (II)*      |
| C0603X5R225MCTS | C0603X5R225MCT  | 0.5V, 1kHz     | 2.2                 | uF          | ±20% | 0.30                | ±0.09       | ±0.09         | 20.0%  | (II)*     |                  |            |
| 4V              | C0603X5R224□BTS | C0603X5R224□BT | 0.5V, 1kHz          | 220         | nF   | ±10%, ±20%          | 0.30        | ±0.03         | ±0.03  | 10.0%     | Paper, 15Kpcs    | (II)       |
|                 | C0603X5R474□BTS | C0603X5R474□BT | 0.5V, 1kHz          | 470         | nF   | ±10%, ±20%          | 0.30        | ±0.03         | ±0.03  | 12.5%     |                  | (II)*      |
|                 | C0603X5R105□BTS | C0603X5R105□BT | 0.5V, 1kHz          | 1.0         | uF   | ±10%, ±20%          | 0.30        | ±0.05         | ±0.05  | 10.0%     |                  | (II)*      |

## ● C1005X5R Series (EIA0402)

| RV              | DARFON P/N       | DARFON P/N 2   | Measuring Condition | Capacitance |      | Available Tolerance | Thick. (mm) | Tolerance(mm) |        | DF (max.) | Standard Packing | Test Spec.    |        |
|-----------------|------------------|----------------|---------------------|-------------|------|---------------------|-------------|---------------|--------|-----------|------------------|---------------|--------|
|                 |                  |                |                     | Value       | Unit |                     |             | L/W           | Thick. |           |                  |               |        |
| 50V             | C1005X5R103KGTS  | C1005X5R103KGT | 1V, 1kHz            | 10          | nF   | ±10%                | 0.50        | ±0.05         | ±0.05  | 5.0%      | Paper, 10Kpcs    | (I)           |        |
|                 | C1005X5R473KGTS  | C1005X5R473KGT | 1V, 1kHz            | 47          | nF   | ±10%                | 0.50        | ±0.05         | ±0.05  | 5.0%      |                  | (I)           |        |
|                 | C1005X5R104□GTS  | C1005X5R104□GT | 1V, 1kHz            | 100         | nF   | ±10%, ±20%          | 0.50        | ±0.05         | ±0.05  | 10.0%     |                  | (II)          |        |
|                 | C1005X5R474□GTS  | C1005X5R474□GT | 1V, 1kHz            | 470         | nF   | ±10%, ±20%          | 0.50        | ±0.10         | ±0.10  | 10.0%     |                  | (II)          |        |
|                 | C1005X5R105KGTS  | C1005X5R105KGT | 1V, 1kHz            | 1           | uF   | ±10%                | 0.50        | ±0.20         | ±0.20  | 10.0%     |                  | (II)          |        |
| 35V             | C1005X5R105□NTS  | C1005X5R105□NT | 1V, 1kHz            | 1.0         | uF   | ±10%, ±20%          | 0.50        | ±0.10         | ±0.10  | 10.0%     | Paper, 10Kpcs    | (III)*        |        |
|                 | C1005X5R225KNTS  | C1005X5R225KNT | 1V, 1kHz            | 2.2         | uF   | ±10%                | 0.50        | ±0.10         | ±0.10  | 10.0%     |                  | (III)*        |        |
| 25V             | C1005X5R103KFTS  | C1005X5R103KFT | 1V, 1kHz            | 10          | nF   | ±10%                | 0.50        | ±0.05         | ±0.05  | 5.0%      | Paper, 10Kpcs    | (I)           |        |
|                 | C1005X5R223KFTS  | C1005X5R223KFT | 1V, 1kHz            | 22          | nF   | ±10%                | 0.50        | ±0.05         | ±0.05  | 5.0%      |                  | (I)           |        |
|                 | C1005X5R473KFTS  | C1005X5R473KFT | 1V, 1kHz            | 47          | nF   | ±10%                | 0.50        | ±0.05         | ±0.05  | 5.0%      |                  | (I)           |        |
|                 | C1005X5R683KFTS  | C1005X5R683KFT | 1V, 1kHz            | 68          | nF   | ±10%                | 0.50        | ±0.05         | ±0.05  | 5.0%      |                  | (I)           |        |
|                 | C1005X5R104□FTS  | C1005X5R104□FT | 1V, 1kHz            | 100         | nF   | ±10%, ±20%          | 0.50        | ±0.05         | ±0.05  | 5.0%      |                  | (I)           |        |
|                 | C1005X5R224□FTS  | C1005X5R224□FT | 1V, 1kHz            | 220         | nF   | ±10%, ±20%          | 0.50        | ±0.05         | ±0.05  | 10.0%     |                  | (II)          |        |
|                 | C1005X5R474□FTS  | C1005X5R474□FT | 1V, 1kHz            | 470         | nF   | ±10%, ±20%          | 0.50        | ±0.05         | ±0.05  | 12.5%     |                  | (II)          |        |
|                 | C1005X5R105□FTS  | C1005X5R105□FT | 1V, 1kHz            | 1.0         | uF   | ±10%, ±20%          | 0.50        | ±0.10         | ±0.10  | 12.5%     |                  | (III)*        |        |
|                 | C1005X5R225□FTS  | C1005X5R225□FT | 1V, 1kHz            | 2.2         | uF   | ±10%, ±20%          | 0.50        | ±0.20         | ±0.20  | 10.0%     |                  | (II)          |        |
| 16V             | C1005X5R153□ETS  | C1005X5R153□ET | 1V, 1kHz            | 15          | nF   | ±10%, ±20%          | 0.50        | ±0.05         | ±0.05  | 5.0%      | Paper, 10Kpcs    | (I)           |        |
|                 | C1005X5R223□ETS  | C1005X5R223□ET | 1V, 1kHz            | 22          | nF   | ±10%, ±20%          | 0.50        | ±0.05         | ±0.05  | 5.0%      |                  | (I)           |        |
|                 | C1005X5R333□ETS  | C1005X5R333□ET | 1V, 1kHz            | 33          | nF   | ±10%, ±20%          | 0.50        | ±0.05         | ±0.05  | 5.0%      |                  | (I)           |        |
|                 | C1005X5R473□ETS  | C1005X5R473□ET | 1V, 1kHz            | 47          | nF   | ±10%, ±20%          | 0.50        | ±0.05         | ±0.05  | 5.0%      |                  | (I)           |        |
|                 | C1005X5R563□ETS  | C1005X5R563□ET | 1V, 1kHz            | 56          | nF   | ±10%, ±20%          | 0.50        | ±0.05         | ±0.05  | 5.0%      |                  | (I)           |        |
|                 | C1005X5R683□ETS  | C1005X5R683□ET | 1V, 1kHz            | 68          | nF   | ±10%, ±20%          | 0.50        | ±0.05         | ±0.05  | 5.0%      |                  | (I)           |        |
|                 | C1005X5R823□ETS  | C1005X5R823□ET | 1V, 1kHz            | 82          | nF   | ±10%, ±20%          | 0.50        | ±0.05         | ±0.05  | 5.0%      |                  | (I)           |        |
|                 | C1005X5R104□ETS  | C1005X5R104□ET | 1V, 1kHz            | 100         | nF   | ±10%, ±20%          | 0.50        | ±0.05         | ±0.05  | 5.0%      |                  | (I)           |        |
|                 | C1005X5R124□ETS  | C1005X5R124□ET | 1V, 1kHz            | 120         | nF   | ±10%, ±20%          | 0.50        | ±0.05         | ±0.05  | 7.5%      |                  | (II)          |        |
|                 | C1005X5R154□ETS  | C1005X5R154□ET | 1V, 1kHz            | 150         | nF   | ±10%, ±20%          | 0.50        | ±0.05         | ±0.05  | 7.5%      |                  | (II)          |        |
|                 | C1005X5R184□ETS  | C1005X5R184□ET | 1V, 1kHz            | 180         | nF   | ±10%, ±20%          | 0.50        | ±0.05         | ±0.05  | 7.5%      |                  | (II)          |        |
|                 | C1005X5R224□ETS  | C1005X5R224□ET | 1V, 1kHz            | 220         | nF   | ±10%, ±20%          | 0.50        | ±0.05         | ±0.05  | 10.0%     |                  | (II)          |        |
|                 | C1005X5R684□ETS  | C1005X5R684□ET | 1V, 1kHz            | 680         | nF   | ±10%, ±20%          | 0.50        | ±0.05         | ±0.05  | 12.5%     |                  | (II)          |        |
|                 | C1005X5R105□ETS  | C1005X5R105□ET | 1V, 1kHz            | 1.0         | uF   | ±10%, ±20%          | 0.50        | ±0.05         | ±0.05  | 12.5%     |                  | (II)          |        |
|                 | C1005X5R225□ETS  | C1005X5R225□ET | 1V, 1kHz            | 2.2         | uF   | ±10%, ±20%          | 0.50        | ±0.10         | ±0.10  | 12.5%     |                  | (III)*        |        |
| 10V             | C1005X5R153□DTS  | C1005X5R153□DT | 1V, 1kHz            | 15          | nF   | ±10%, ±20%          | 0.50        | ±0.05         | ±0.05  | 7.5%      | Paper, 10Kpcs    | (I)           |        |
|                 | C1005X5R223□DTS  | C1005X5R223□DT | 1V, 1kHz            | 22          | nF   | ±10%, ±20%          | 0.50        | ±0.05         | ±0.05  | 7.5%      |                  | (I)           |        |
|                 | C1005X5R333□DTS  | C1005X5R333□DT | 1V, 1kHz            | 33          | nF   | ±10%, ±20%          | 0.50        | ±0.05         | ±0.05  | 7.5%      |                  | (I)           |        |
|                 | C1005X5R473□DTS  | C1005X5R473□DT | 1V, 1kHz            | 47          | nF   | ±10%, ±20%          | 0.50        | ±0.05         | ±0.05  | 7.5%      |                  | (I)           |        |
|                 | C1005X5R563□DTS  | C1005X5R563□DT | 1V, 1kHz            | 56          | nF   | ±10%, ±20%          | 0.50        | ±0.05         | ±0.05  | 7.5%      |                  | (I)           |        |
|                 | C1005X5R683□DTS  | C1005X5R683□DT | 1V, 1kHz            | 68          | nF   | ±10%, ±20%          | 0.50        | ±0.05         | ±0.05  | 7.5%      |                  | (I)           |        |
|                 | C1005X5R823□DTS  | C1005X5R823□DT | 1V, 1kHz            | 82          | nF   | ±10%, ±20%          | 0.50        | ±0.05         | ±0.05  | 7.5%      |                  | (I)           |        |
|                 | C1005X5R104□DTS  | C1005X5R104□DT | 1V, 1kHz            | 100         | nF   | ±10%, ±20%          | 0.50        | ±0.05         | ±0.05  | 7.5%      |                  | (I)           |        |
|                 | C1005X5R124□DTS  | C1005X5R124□DT | 1V, 1kHz            | 120         | nF   | ±10%, ±20%          | 0.50        | ±0.05         | ±0.05  | 7.5%      |                  | (II)          |        |
|                 | C1005X5R154□DTS  | C1005X5R154□DT | 1V, 1kHz            | 150         | nF   | ±10%, ±20%          | 0.50        | ±0.05         | ±0.05  | 7.5%      |                  | (II)          |        |
|                 | C1005X5R184□DTS  | C1005X5R184□DT | 1V, 1kHz            | 180         | nF   | ±10%, ±20%          | 0.50        | ±0.05         | ±0.05  | 7.5%      |                  | (II)          |        |
|                 | C1005X5R224□DTS  | C1005X5R224□DT | 1V, 1kHz            | 220         | nF   | ±10%, ±20%          | 0.50        | ±0.05         | ±0.05  | 7.5%      |                  | (II)          |        |
|                 | C1005X5R334□DTS  | C1005X5R334□DT | 1V, 1kHz            | 330         | nF   | ±10%, ±20%          | 0.50        | ±0.05         | ±0.05  | 10.0%     |                  | (II)          |        |
|                 | C1005X5R394□DTS  | C1005X5R394□DT | 1V, 1kHz            | 390         | nF   | ±10%, ±20%          | 0.50        | ±0.05         | ±0.05  | 10.0%     |                  | (II)          |        |
|                 | C1005X5R474□DTS  | C1005X5R474□DT | 1V, 1kHz            | 470         | nF   | ±10%, ±20%          | 0.50        | ±0.05         | ±0.05  | 10.0%     |                  | (II)          |        |
|                 | C1005X5R684□DTS  | C1005X5R684□DT | 1V, 1kHz            | 680         | nF   | ±10%, ±20%          | 0.50        | ±0.05         | ±0.05  | 10.0%     |                  | (II)          |        |
|                 | C1005X5R105□DTS  | C1005X5R105□DT | 1V, 1kHz            | 1.0         | uF   | ±10%, ±20%          | 0.50        | ±0.05         | ±0.05  | 10.0%     |                  | (II)          |        |
|                 | C1005X5R225□DTS  | C1005X5R225□DT | 0.5V, 1kHz          | 2.2         | uF   | ±10%, ±20%          | 0.50        | ±0.05         | ±0.05  | 10.0%     |                  | (III)*        |        |
|                 | C1005X5R475□DTS  | C1005X5R475□DT | 1V, 1kHz            | 4.7         | uF   | ±10%, ±20%          | 0.50        | ±0.15         | ±0.15  | 12.5%     |                  | (III)*        |        |
|                 | C1005X5R106MDTS  | C1005X5R106MDT | 0.5V, 1kHz          | 10          | uF   | ±20%                | 0.50        | ±0.20         | ±0.20  | 12.5%     |                  | (III)*        |        |
| 6.3V            | C1005X5R223KCTS  | C1005X5R223KCT | 1V, 1kHz            | 22          | nF   | ±10%                | 0.50        | ±0.05         | ±0.05  | 7.5%      | Paper, 10Kpcs    | (I)           |        |
|                 | C1005X5R224□CTS  | C1005X5R224□CT | 1V, 1kHz            | 220         | nF   | ±10%, ±20%          | 0.50        | ±0.05         | ±0.05  | 10.0%     |                  | (II)          |        |
|                 | C1005X5R334□CTS  | C1005X5R334□CT | 1V, 1kHz            | 330         | nF   | ±10%, ±20%          | 0.50        | ±0.05         | ±0.05  | 10.0%     |                  | (II)          |        |
|                 | C1005X5R474□CTS  | C1005X5R474□CT | 1V, 1kHz            | 470         | nF   | ±10%, ±20%          | 0.50        | ±0.05         | ±0.05  | 10.0%     |                  | (II)          |        |
|                 | C1005X5R684□CTS  | C1005X5R684□CT | 1V, 1kHz            | 680         | nF   | ±10%, ±20%          | 0.50        | ±0.05         | ±0.05  | 10.0%     |                  | (II)          |        |
|                 | C1005X5R105MCTSA |                | 1V, 1kHz            | 1.0         | uF   | ±20%                | 0.30        | ±0.05         | ±0.03  | 12.5%     |                  | Paper, 15Kpcs | (III)* |
|                 | C1005X5R105□CTS  | C1005X5R105□CT | 0.5V, 1kHz          | 1.0         | uF   | ±10%, ±20%          | 0.50        | ±0.05         | ±0.05  | 12.5%     |                  | Paper, 10Kpcs | (II)   |
|                 | C1005X5R225MCTSA |                | 0.5V, 1kHz          | 2.2         | uF   | ±20%                | 0.30        | ±0.05         | ±0.03  | 10.0%     |                  | Paper, 15Kpcs | (III)* |
|                 | C1005X5R225□CTS  | C1005X5R225□CT | 0.5V, 1kHz          | 2.2         | uF   | ±10%, ±20%          | 0.50        | ±0.05         | ±0.05  | 10.0%     |                  | Paper, 10Kpcs | (III)* |
|                 | C1005X5R475MCTSA |                | 0.5V, 1kHz          | 4.7         | uF   | ±20%                | 0.30        | ±0.20         | ±0.03  | 10.0%     |                  | Paper, 15Kpcs | (III)* |
|                 | C1005X5R475□CTS  | C1005X5R475□CT | 0.5V, 1kHz          | 4.7         | uF   | ±10%, ±20%          | 0.50        | ±0.15         | ±0.15  | 10.0%     |                  | (III)*        |        |
|                 | C1005X5R106MCTS  | C1005X5R106MCT | 0.5V, 1kHz          | 10          | uF   | ±20%                | 0.50        | ±0.20         | ±0.20  | 15.0%     |                  | Paper, 10Kpcs | (III)* |
| C1005X5R226MCTS | C1005X5R226MCT   | 0.5V, 120Hz    | 22                  | uF          | ±20% | 0.50                | ±0.20       | ±0.20         | 15.0%  | (III)*    |                  |               |        |
| 4V              | C1005X5R105□BTS  | C1005X5R105□BT | 1V, 1kHz            | 1.0         | uF   | ±10%, ±20%          | 0.50        | ±0.05         | ±0.05  | 15.0%     | Paper, 10Kpcs    | (II)          |        |
|                 | C1005X5R225□BTS  | C1005X5R225□BT | 0.5V, 1kHz          | 2.2         | uF   | ±10%, ±20%          | 0.50        | ±0.05         | ±0.05  | 10.0%     |                  | (II)          |        |
|                 | C1005X5R225MBTSA |                | 0.5V, 1kHz          | 2.2         | uF   | ±20%                | 0.30        | ±0.05         | ±0.03  | 10.0%     | Paper, 15Kpcs    | (II)          |        |
|                 | C1005X5R475□BTS  | C1005X5R475□BT | 0.5V, 1kHz          | 4.7         | uF   | ±10%, ±20%          | 0.50        | ±0.15         | ±0.15  | 10.0%     | (II)             |               |        |
|                 | C1005X5R106MBTS  | C1005X5R106MBT | 0.5V, 1kHz          | 10.0        | uF   | ±20%                | 0.50        | ±0.20         | ±0.20  | 15.0%     | Paper, 10Kpcs    | (II)          |        |
| C1005X5R226MBTS | C1005X5R226MBT   | 0.5V, 120Hz    | 22                  | uF          | ±20% | 0.50                | ±0.20       | ±0.20         | 15.0%  | (II)*     |                  |               |        |

□ Tolerance Code: K=±10%, M=±20% ;Special tolerance on the request.

(II)\* High temperature load life test are applicable in rated voltage \*100%

● C1608X5R Series (EIA0603)

| RV              | DARFON P/N       | DARFON P/N 2   | Measuring Condition | Capacitance |            | Available Tolerance | Thick. (mm) | Tolerance(mm) |          | DF (max.) | Standard Packing | Test Spec.      |
|-----------------|------------------|----------------|---------------------|-------------|------------|---------------------|-------------|---------------|----------|-----------|------------------|-----------------|
|                 |                  |                |                     | Value       | Unit       |                     |             | L/W           | Thick.   |           |                  |                 |
| 50V             | C1608X5R102KGTS  | C1608X5R102KGT | 1V, 1kHz            | 1.0         | nF         | ±10%                | 0.80        | ±0.10         | ±0.10    | 5.0%      | Paper, 4Kpcs     | (I)             |
|                 | C1608X5R103KGTS  | C1608X5R103KGT | 1V, 1kHz            | 10          | nF         | ±10%                | 0.80        | ±0.10         | ±0.10    | 5.0%      |                  | (I)             |
|                 | C1608X5R333KGTS  | C1608X5R333KGT | 1V, 1kHz            | 33          | nF         | ±10%                | 0.80        | ±0.15         | ±0.15    | 5.0%      |                  | (I)             |
|                 | C1608X5R224KGT   | C1608X5R224KGT | 1V, 1kHz            | 220         | nF         | ±10%                | 0.80        | ±0.15         | ±0.15    | 5.0%      |                  | (II)            |
|                 | C1608X5R474□GTS  | C1608X5R474□GT | 1V, 1kHz            | 470         | nF         | ±10%, ±20%          | 0.80        | ±0.15         | ±0.15    | 10.0%     |                  | (II)            |
|                 | C1608X5R105□GTS  | C1608X5R105□GT | 1V, 1kHz            | 1.0         | uF         | ±10%, ±20%          | 0.80        | ±0.10         | ±0.10    | 10.0%     |                  | (II)            |
| 35V             | C1608X5R225□GTS  | C1608X5R225□GT | 1V, 1kHz            | 2.2         | uF         | ±10%, ±20%          | 0.80        | ±0.20         | ±0.20    | 10.0%     | Paper, 4Kpcs     | (II)            |
|                 | C1608X5R105□NTS  | C1608X5R105□NT | 1V, 1kHz            | 1.0         | uF         | ±10%, ±20%          | 0.80        | ±0.10         | ±0.10    | 10.0%     |                  | (II)*           |
|                 | C1608X5R225□NTS  | C1608X5R225□NT | 1V, 1kHz            | 2.2         | uF         | ±10%, ±20%          | 0.80        | ±0.10         | ±0.10    | 10.0%     |                  | (II)*           |
|                 | C1608X5R475□NTS  | C1608X5R475□NT | 1V, 1kHz            | 4.7         | uF         | ±10%, ±20%          | 0.80        | ±0.20         | ±0.20    | 10.0%     |                  | (II)*           |
| 25V             | C1608X5R106MNTS  | C1608X5R106MNT | 1V, 1kHz            | 10          | uF         | ±20%                | 0.80        | ±0.20         | ±0.20    | 10.0%     | Paper, 4Kpcs     | (II)*           |
|                 | C1608X5R104□FTS  | C1608X5R104□FT | 1V, 1kHz            | 100         | nF         | ±10%, ±20%          | 0.80        | ±0.10         | ±0.10    | 5.0%      |                  | (I)             |
|                 | C1608X5R224□FTS  | C1608X5R224□FT | 1V, 1kHz            | 220         | nF         | ±10%, ±20%          | 0.80        | ±0.10         | ±0.10    | 5.0%      |                  | (I)             |
|                 | C1608X5R334KFTS  | C1608X5R334KFT | 1V, 1kHz            | 330         | nF         | ±10%                | 0.80        | ±0.15         | ±0.15    | 7.5%      |                  | (I)             |
|                 | C1608X5R474□FTS  | C1608X5R474□FT | 1V, 1kHz            | 470         | nF         | ±10%, ±20%          | 0.80        | ±0.10         | ±0.10    | 5.0%      |                  | (II)            |
|                 | C1608X5R105□FTS  | C1608X5R105□FT | 1V, 1kHz            | 1.0         | uF         | ±10%, ±20%          | 0.80        | ±0.15         | ±0.15    | 10.0%     |                  | (II)            |
|                 | C1608X5R105□FTSB |                | 1V, 1kHz            | 1.0         | uF         | ±10%, ±20%          | 0.50        | ±0.10         | +0/-0.10 | 12.5%     |                  | (II)*           |
|                 | C1608X5R225□FTS  | C1608X5R225□FT | 1V, 1kHz            | 2.2         | uF         | ±10%, ±20%          | 0.80        | ±0.15         | ±0.15    | 10.0%     |                  | (II)            |
| 16V             | C1608X5R475□FTS  | C1608X5R475□FT | 1V, 1kHz            | 4.7         | uF         | ±10%, ±20%          | 0.80        | ±0.20         | ±0.20    | 10.0%     | Paper, 4Kpcs     | (II)            |
|                 | C1608X5R106MFTS  | C1608X5R106MFT | 1V, 1kHz            | 10          | uF         | ±20%                | 0.80        | ±0.20         | ±0.20    | 10.0%     |                  | (II)            |
|                 | C1608X5R104□ETS  | C1608X5R104□ET | 1V, 1kHz            | 100         | nF         | ±10%, ±20%          | 0.80        | ±0.10         | ±0.10    | 5.0%      |                  | (I)             |
|                 | C1608X5R224□ETS  | C1608X5R224□ET | 1V, 1kHz            | 220         | nF         | ±10%, ±20%          | 0.80        | ±0.10         | ±0.10    | 5.0%      |                  | (I)             |
|                 | C1608X5R334□ETS  | C1608X5R334□ET | 1V, 1kHz            | 330         | nF         | ±10%, ±20%          | 0.80        | ±0.10         | ±0.10    | 5.0%      |                  | (I)             |
|                 | C1608X5R474□ETS  | C1608X5R474□ET | 1V, 1kHz            | 470         | nF         | ±10%, ±20%          | 0.80        | ±0.10         | ±0.10    | 3.5%      |                  | (II)            |
|                 | C1608X5R684□ETS  | C1608X5R684□ET | 1V, 1kHz            | 680         | nF         | ±10%, ±20%          | 0.80        | ±0.10         | ±0.10    | 7.5%      |                  | (II)            |
|                 | C1608X5R105□ETS  | C1608X5R105□ET | 1V, 1kHz            | 1.0         | uF         | ±10%, ±20%          | 0.80        | ±0.10         | ±0.10    | 10.0%     |                  | (II)            |
| 10V             | C1608X5R105□ETSB |                | 0.5V, 1kHz          | 1.0         | uF         | ±10%, ±20%          | 0.50        | ±0.10         | +0/-0.10 | 10.0%     | Paper, 4Kpcs     | (II)            |
|                 | C1608X5R225□ETS  | C1608X5R225□ET | 1V, 1kHz            | 2.2         | uF         | ±10%, ±20%          | 0.80        | ±0.10         | ±0.10    | 10.0%     |                  | (II)            |
|                 | C1608X5R475□ETS  | C1608X5R475□ET | 1V, 1kHz            | 4.7         | uF         | ±10%, ±20%          | 0.80        | ±0.20         | ±0.15    | 10.0%     |                  | (II)*           |
|                 | C1608X5R106□ETS  | C1608X5R106□ET | 1V, 1kHz            | 10          | uF         | ±10%, ±20%          | 0.80        | ±0.20         | ±0.20    | 10.0%     |                  | (II)*           |
|                 | C1608X5R104□DTS  | C1608X5R104□DT | 1V, 1kHz            | 100         | nF         | ±10%, ±20%          | 0.80        | ±0.10         | ±0.10    | 7.5%      |                  | (I)             |
|                 | C1608X5R224□DTS  | C1608X5R224□DT | 1V, 1kHz            | 220         | nF         | ±10%, ±20%          | 0.80        | ±0.10         | ±0.10    | 7.5%      |                  | (I)             |
|                 | C1608X5R334□DTS  | C1608X5R334□DT | 1V, 1kHz            | 330         | nF         | ±10%, ±20%          | 0.80        | ±0.10         | ±0.10    | 7.5%      |                  | (I)             |
|                 | C1608X5R474□DTS  | C1608X5R474□DT | 1V, 1kHz            | 470         | nF         | ±10%, ±20%          | 0.80        | ±0.10         | ±0.10    | 7.5%      |                  | (I)             |
|                 | C1608X5R684□DTS  | C1608X5R684□DT | 1V, 1kHz            | 680         | nF         | ±10%, ±20%          | 0.80        | ±0.10         | ±0.10    | 7.5%      |                  | (I)             |
|                 | C1608X5R105□DTS  | C1608X5R105□DT | 1V, 1kHz            | 1.0         | uF         | ±10%, ±20%          | 0.80        | ±0.10         | ±0.10    | 7.5%      |                  | (II)            |
|                 | C1608X5R105□DTSB |                | 1V, 1kHz            | 1.0         | uF         | ±10%, ±20%          | 0.50        | ±0.10         | +0/-0.10 | 10.0%     |                  | (II)            |
|                 | C1608X5R225□DTS  | C1608X5R225□DT | 1V, 1kHz            | 2.2         | uF         | ±10%, ±20%          | 0.80        | ±0.10/±0.15   | ±0.15    | 10.0%     |                  | (II)            |
|                 | C1608X5R225□DTSB |                | 0.5V, 1kHz          | 2.2         | uF         | ±10%, ±20%          | 0.50        | ±0.10         | +0/-0.10 | 10.0%     |                  | (II)*           |
|                 | C1608X5R335□DTS  | C1608X5R335□DT | 1V, 1kHz            | 3.3         | uF         | ±10%, ±20%          | 0.80        | ±0.15         | ±0.15    | 10.0%     |                  | (II)            |
| C1608X5R475□DTS | C1608X5R475□DT   | 1V, 1kHz       | 4.7                 | uF          | ±10%, ±20% | 0.80                | ±0.15       | ±0.15         | 10.0%    | (II)      |                  |                 |
| 6.3V            | C1608X5R475□DTSB |                | 1V, 1kHz            | 4.7         | uF         | ±10%, ±20%          | 0.50        | ±0.20         | ±0.05    | 10.0%     | Paper, 4Kpcs     | (II)            |
|                 | C1608X5R106□DTS  | C1608X5R106□DT | 1V, 1kHz            | 10          | uF         | ±10%, ±20%          | 0.80        | ±0.20         | ±0.20    | 10.0%     |                  | (II)*           |
|                 | C1608X5R226MDTS  | C1608X5R226MDT | 0.5V, 120Hz         | 22          | uF         | ±20%                | 0.80        | ±0.25         | ±0.25    | 10.0%     |                  | (II)*           |
|                 | C1608X5R226MDWS  | C1608X5R226MDW | 0.5V, 120Hz         | 22          | uF         | ±20%                | 0.80        | ±0.20         | ±0.20    | 10.0%     |                  | Embossed, 4Kpcs |
|                 | C1608X5R104□CTS  | C1608X5R104□CT | 1V, 1kHz            | 100         | nF         | ±10%, ±20%          | 0.80        | ±0.10         | ±0.10    | 7.5%      |                  | (I)             |
|                 | C1608X5R105□CTS  | C1608X5R105□CT | 1V, 1kHz            | 1.0         | uF         | ±10%, ±20%          | 0.80        | ±0.10         | ±0.10    | 7.5%      |                  | (II)            |
|                 | C1608X5R225□CTS  | C1608X5R225□CT | 0.5V, 1kHz          | 2.2         | uF         | ±10%, ±20%          | 0.80        | ±0.10         | ±0.10    | 10.0%     |                  | (II)            |
|                 | C1608X5R335KCTS  | C1608X5R335KCT | 1V, 1kHz            | 3.3         | uF         | ±10%                | 0.80        | ±0.15         | ±0.15    | 10.0%     |                  | (II)            |
|                 | C1608X5R475□CTS  | C1608X5R475□CT | 0.5V, 1kHz          | 4.7         | uF         | ±10%, ±20%          | 0.80        | ±0.10         | ±0.10    | 10.0%     |                  | (II)            |
|                 | C1608X5R106MCTSB |                | 0.5V, 1kHz          | 10          | uF         | ±20%                | 0.50        | ±0.10         | ±0.10    | 10.0%     |                  | (II)*           |
| 4V              | C1608X5R106□CTS  | C1608X5R106□CT | 0.5V, 1kHz          | 10          | uF         | ±10%, ±20%          | 0.80        | ±0.15         | ±0.15    | 10.0%     | Paper, 4Kpcs     | (II)*           |
|                 | C1608X5R226MCTS  | C1608X5R226MCT | 0.5V, 120Hz         | 22          | uF         | ±20%                | 0.80        | ±0.20         | ±0.20    | 15.0%     |                  | (II)*           |
|                 | C1608X5R476MCTS  | C1608X5R476MCT | 0.5V, 120Hz         | 47          | uF         | ±20%                | 0.80        | ±0.20         | ±0.20    | 12.5%     |                  | (II)*           |
|                 | C1608X5R106MBTS  | C1608X5R106MBT | 0.5V, 1kHz          | 10          | uF         | ±20%                | 0.80        | ±0.10         | ±0.10    | 10.0%     |                  | (II)            |
| 4V              | C1608X5R226MBTS  | C1608X5R226MBT | 0.5V, 120Hz         | 22          | uF         | ±20%                | 0.80        | ±0.20         | ±0.20    | 10.0%     | Paper, 4Kpcs     | (II)*           |
|                 | C1608X5R476MBTS  | C1608X5R476MBT | 0.5V, 120Hz         | 47          | uF         | ±20%                | 0.80        | ±0.20         | ±0.20    | 12.5%     |                  | (II)*           |

● C2012X5R Series (EIA0805)

| RV              | DARFON P/N      | DARFON P/N 2   | Measuring Condition | Capacitance |      | Available Tolerance | Thick. (mm) | Tolerance(mm) |        | DF (max.)       | Standard Packing | Test Spec. |
|-----------------|-----------------|----------------|---------------------|-------------|------|---------------------|-------------|---------------|--------|-----------------|------------------|------------|
|                 |                 |                |                     | Value       | Unit |                     |             | L/W           | Thick. |                 |                  |            |
| 50V             | C2012X5R105□GTS | C2012X5R105□GT | 1V, 1kHz            | 1.0         | uF   | ±10%, ±20%          | 0.85        | ±0.15         | ±0.15  | 10.0%           | Paper, 4Kpcs     | (II)       |
|                 | C2012X5R225□GTS | C2012X5R225□GT | 1V, 1kHz            | 2.2         | uF   | ±10%, ±20%          | 0.85        | ±0.20         | ±0.15  | 10.0%           |                  | (II)       |
|                 | C2012X5R105□GPS | C2012X5R105□GP | 1V, 1kHz            | 1.0         | uF   | ±10%, ±20%          | 1.25        | ±0.15         | ±0.20  | 10.0%           | Embossed, 3Kpcs  | (II)       |
|                 | C2012X5R225□GPS | C2012X5R225□GP | 1V, 1kHz            | 2.2         | uF   | ±10%, ±20%          | 1.25        | ±0.15         | ±0.20  | 10.0%           |                  | (II)       |
|                 | C2012X5R475□GPS | C2012X5R475□GP | 1V, 1kHz            | 4.7         | uF   | ±10%, ±20%          | 1.25        | ±0.20         | ±0.20  | 10.0%           |                  | (II)       |
| C2012X5R106MGPS | C2012X5R106MGP  | 1V, 1kHz       | 10.0                | uF          | ±20% | 1.25                | ±0.20       | ±0.20         | 10.0%  | (II)*           |                  |            |
| 35V             | C2012X5R106KNPS | C2012X5R106KNP | 1V, 1kHz            | 10.0        | uF   | ±10%                | 1.25        | ±0.20         | ±0.20  | 10.0%           | Embossed, 3Kpcs  | (II)*      |
| 25V             | C2012X5R105□FTS | C2012X5R105□FT | 1V, 1kHz            | 1.0         | uF   | ±10%, ±20%          | 0.85        | ±0.15         | ±0.10  | 10.0%           | Paper, 4Kpcs     | (II)       |
|                 | C2012X5R105□FPS | C2012X5R105□FP | 1V, 1kHz            | 1.0         | uF   | ±10%, ±20%          | 1.25        | ±0.20         | ±0.20  | 10.0%           | Embossed, 3Kpcs  | (I)        |
|                 | C2012X5R225□FTS | C2012X5R225□FT | 1V, 1kHz            | 2.2         | uF   | ±10%, ±20%          | 0.85        | ±0.20         | ±0.10  | 10.0%           | Paper, 4Kpcs     | (II)       |
|                 | C2012X5R225□FPS | C2012X5R225□FP | 1V, 1kHz            | 2.2         | uF   | ±10%, ±20%          | 1.25        | ±0.15         | ±0.20  | 10.0%           | Embossed, 3Kpcs  | (II)       |
|                 | C2012X5R475□FTS | C2012X5R475□FT | 1V, 1kHz            | 4.7         | uF   | ±10%, ±20%          | 0.85        | ±0.20         | ±0.10  | 10.0%           | Paper, 4Kpcs     | (II)*      |
|                 | C2012X5R475□FPS | C2012X5R475□FP | 1V, 1kHz            | 4.7         | uF   | ±10%, ±20%          | 1.25        | ±0.15         | ±0.20  | 10.0%           | Embossed, 3Kpcs  | (II)       |
|                 | C2012X5R106□FTS | C2012X5R106□FT | 1V, 1kHz            | 10          | uF   | ±10%, ±20%          | 0.85        | ±0.20         | ±0.10  | 12.5%           | Paper, 4Kpcs     | (II)*      |
|                 | C2012X5R106□FPS | C2012X5R106□FP | 1V, 1kHz            | 10          | uF   | ±10%, ±20%          | 1.25        | ±0.20         | ±0.20  | 12.5%           | Embossed, 3Kpcs  | (II)*      |
|                 | C2012X5R226MFPS | C2012X5R226MFP | 0.5V, 120Hz         | 22          | uF   | ±20%                | 1.25        | ±0.20         | ±0.20  | 15.0%           | Paper, 4Kpcs     | (II)       |
| C2012X5R226MFWS | C2012X5R226MFW  | 0.5V, 120Hz    | 22                  | uF          | ±20% | 1.25                | ±0.20       | ±0.20         | 15.0%  | Embossed, 2Kpcs | (II)             |            |
| 16V             | C2012X5R105□ETS | C2012X5R105□ET | 1V, 1kHz            | 1.0         | uF   | ±10%, ±20%          | 0.85        | ±0.15         | ±0.15  | 10.0%           | Paper, 4Kpcs     | (II)       |
|                 | C2012X5R105□EPS | C2012X5R105□EP | 1V, 1kHz            | 1.0         | uF   | ±10%, ±20%          | 1.25        | ±0.15         | ±0.20  | 5.0%            | Embossed, 3Kpcs  | (I)        |
|                 | C2012X5R225□ETS | C2012X5R225□ET | 1V, 1kHz            | 2.2         | uF   | ±10%, ±20%          | 1.25        | ±0.15         | ±0.20  | 5.0%            |                  | (II)       |
|                 | C2012X5R335□ETS | C2012X5R335□ET | 1V, 1kHz            | 3.3         | uF   | ±10%, ±20%          | 1.25        | ±0.20         | ±0.20  | 10.0%           |                  | (II)       |
|                 | C2012X5R475□ETS | C2012X5R475□ET | 0.5V, 1kHz          | 4.7         | uF   | ±10%, ±20%          | 0.85        | ±0.20         | ±0.10  | 10.0%           | Paper, 4Kpcs     | (II)       |
|                 | C2012X5R475□EPS | C2012X5R475□EP | 1V, 1kHz            | 4.7         | uF   | ±10%, ±20%          | 1.25        | ±0.15         | ±0.20  | 7.5%            | Embossed, 3Kpcs  | (II)       |
|                 | C2012X5R106□ETS | C2012X5R106□ET | 1V, 1kHz            | 10          | uF   | ±10%, ±20%          | 0.85        | ±0.15         | ±0.10  | 10.0%           | Paper, 4Kpcs     | (II)*      |
|                 | C2012X5R106□EPS | C2012X5R106□EP | 0.5V, 1kHz          | 10          | uF   | ±10%, ±20%          | 1.25        | ±0.15         | ±0.20  | 10.0%           | Embossed, 3Kpcs  | (II)*      |
| C2012X5R226METS | C2012X5R226MET  | 0.5V, 120Hz    | 22                  | uF          | ±20% | 0.85                | ±0.20       | ±0.10         | 10.0%  | Paper, 4Kpcs    | (II)*            |            |
| 10V             | C2012X5R225□DTS | C2012X5R225□DT | 1V, 1kHz            | 2.2         | uF   | ±10%, ±20%          | 0.85        | ±0.15         | ±0.10  | 10.0%           | Paper, 4Kpcs     | (II)       |
|                 | C2012X5R335□DPS | C2012X5R335□DP | 1V, 1kHz            | 3.3         | uF   | ±10%, ±20%          | 1.25        | ±0.20         | ±0.20  | 10.0%           | Embossed, 3Kpcs  | (II)       |
|                 | C2012X5R475□DPS | C2012X5R475□DP | 1V, 1kHz            | 4.7         | uF   | ±10%, ±20%          | 1.25        | ±0.15         | ±0.20  | 10.0%           |                  | (II)       |
|                 | C2012X5R106□DTS | C2012X5R106□DT | 0.5V, 1kHz          | 10          | uF   | ±10%, ±20%          | 0.85        | ±0.20         | ±0.10  | 10.0%           | Paper, 4Kpcs     | (II)       |
|                 | C2012X5R106□DPS | C2012X5R106□DP | 0.5V, 1kHz          | 10          | uF   | ±10%, ±20%          | 1.25        | ±0.15         | ±0.20  | 10.0%           | Embossed, 3Kpcs  | (II)       |
|                 | C2012X5R226MDTS | C2012X5R226MDT | 0.5V, 120Hz         | 22          | uF   | ±20%                | 0.85        | ±0.20         | ±0.15  | 10.0%           | Paper, 4Kpcs     | (II)*      |
|                 | C2012X5R476MDPS | C2012X5R476MDP | 0.5V, 120Hz         | 47          | uF   | ±20%                | 1.25        | ±0.20         | ±0.20  | 10.0%           | Embossed, 3Kpcs  | (II)*      |
| 6.3V            | C2012X5R225KCTS | C2012X5R225KCT | 1V, 1kHz            | 2.2         | uF   | ±10%                | 0.85        | ±0.15         | ±0.10  | 10.0%           | Paper, 4Kpcs     | (II)       |
|                 | C2012X5R475□CPS | C2012X5R475□CP | 0.5V, 1kHz          | 4.7         | uF   | ±10%, ±20%          | 1.25        | ±0.15         | ±0.20  | 10.0%           | Embossed, 3Kpcs  | (I)        |
|                 | C2012X5R106□CTS | C2012X5R106□CT | 0.5V, 1kHz          | 10          | uF   | ±10%, ±20%          | 0.85        | ±0.20         | ±0.15  | 10.0%           | Paper, 4Kpcs     | (II)       |
|                 | C2012X5R106□CPS | C2012X5R106□CP | 0.5V, 1kHz          | 10          | uF   | ±10%, ±20%          | 1.25        | ±0.15         | ±0.20  | 10.0%           | Embossed, 3Kpcs  | (II)       |
|                 | C2012X5R226MCTS | C2012X5R226MCT | 0.5V, 120Hz         | 22          | uF   | ±20%                | 0.85        | ±0.15         | ±0.15  | 10.0%           | Paper, 4Kpcs     | (II)       |
|                 | C2012X5R226□CPS | C2012X5R226□CP | 0.5V, 120Hz         | 22          | uF   | ±10%, ±20%          | 1.25        | ±0.15         | ±0.15  | 10.0%           | Embossed, 3Kpcs  | (II)       |
|                 | C2012X5R476MCTS | C2012X5R476MCT | 0.5V, 120Hz         | 47          | uF   | ±20%                | 0.85        | ±0.20         | ±0.15  | 10.0%           | Paper, 4Kpcs     | (II)*      |
|                 | C2012X5R476MCPS | C2012X5R476MCP | 0.5V, 120Hz         | 47          | uF   | ±20%                | 1.25        | ±0.20         | ±0.20  | 10.0%           | Embossed, 3Kpcs  | (II)*      |
| C2012X5R107MCPS | C2012X5R107MCP  | 0.5V, 120Hz    | 100                 | uF          | ±20% | 1.25                | ±0.20       | ±0.20         | 10.0%  | Embossed, 3Kpcs | (II)*            |            |
| 4V              | C2012X5R107MBPS | C2012X5R107MBP | 0.5V, 120Hz         | 100         | uF   | ±20%                | 1.25        | ±0.20         | ±0.20  | 10.0%           | Embossed, 3Kpcs  | (II)*      |

□ Tolerance Code: K=±10%, M=±20% ;(II)\* High temperature load life test are applicable in rated voltage \*100%

### ● C3216X5R Series (EIA1206)

| RV   | DARFON P/N        | DARFON P/N 2    | Measuring Condition | Capacitance |      | Available Tolerance | Thick. (mm) | Tolerance(mm) |        | DF (max.) | Standard Packing | Test Spec. |
|------|-------------------|-----------------|---------------------|-------------|------|---------------------|-------------|---------------|--------|-----------|------------------|------------|
|      |                   |                 |                     | Value       | Unit |                     |             | L/W           | Thick. |           |                  |            |
| 50V  | C3216X5R225□GTS   | C3216X5R225□GT  | 1V, 1kHz            | 2.2         | uF   | ±10%, ±20%          | 0.85        | ±0.15         | ±0.10  | 10.0%     | Paper, 4Kpcs     | (II)       |
|      | C3216X5R475□GTS   | C3216X5R475□GT  | 1V, 1kHz            | 4.7         | uF   | ±10%, ±20%          | 0.85        | ±0.15         | ±0.10  | 10.0%     |                  | (II)       |
|      | C3216X5R475□GPS   | C3216X5R475□GP  | 1V, 1kHz            | 4.7         | uF   | ±10%, ±20%          | 1.60        | ±0.20         | ±0.30  | 10.0%     | Embossed, 2Kpcs  | (II)       |
|      | C3216X5R106□GPS   | C3216X5R106□GP  | 1V, 1kHz            | 10          | uF   | ±10%, ±20%          | 1.60        | ±0.20         | ±0.20  | 10.0%     |                  | (II)       |
| 35V  | C3216X5R106□NTS   | C3216X5R106□NT  | 1V, 1kHz            | 10          | uF   | ±10%, ±20%          | 0.85        | ±0.15         | ±0.10  | 10.0%     | Paper, 4Kpcs     | (II)*      |
|      | C3216X5R106□NPS   | C3216X5R106□NP  | 1V, 1kHz            | 10          | uF   | ±10%, ±20%          | 1.60        | ±0.20         | ±0.30  | 10.0%     | Embossed, 2Kpcs  | (II)       |
| 25V  | C3216X5R105KFTSE  |                 | 1V, 1kHz            | 1.0         | uF   | ±10%                | 0.85        | ±0.15         | ±0.10  | 3.5%      | Paper, 4Kpcs     | (I)        |
|      | C3216X5R225□FPS   | C3216X5R225□FP  | 1V, 1kHz            | 2.2         | uF   | ±10%, ±20%          | 1.60        | ±0.20         | ±0.30  | 5.0%      | Embossed, 2Kpcs  | (I)        |
|      | C3216X5R475□FPS   | C3216X5R475□FP  | 1V, 1kHz            | 4.7         | uF   | ±10%, ±20%          | 1.60        | ±0.20         | ±0.30  | 5.0%      |                  | (I)        |
|      | C3216X5R106□FPS   | C3216X5R106□FP  | 1V, 1kHz            | 10          | uF   | ±10%, ±20%          | 1.60        | ±0.20         | ±0.30  | 10.0%     |                  | (II)       |
|      | C3216X5R226□MFTSE | C3216X5R226□MFT | 0.5V, 120Hz         | 22          | uF   | ±20%                | 0.85        | ±0.20         | ±0.20  | 10.0%     | Paper, 4Kpcs     | (II)*      |
|      | C3216X5R226□FPSSL | C3216X5R226□FP  | 0.5V, 120Hz         | 22          | uF   | ±10%, ±20%          | 1.60        | ±0.30         | ±0.30  | 10.0%     | Embossed, 2Kpcs  | (II)       |
| 16V  | C3216X5R225□EPS   | C3216X5R225□EP  | 1V, 1kHz            | 2.2         | uF   | ±10%, ±20%          | 1.60        | ±0.20         | ±0.30  | 5.0%      | Embossed, 2Kpcs  | (I)        |
|      | C3216X5R475□EPS   | C3216X5R475□EP  | 1V, 1kHz            | 4.7         | uF   | ±10%, ±20%          | 1.60        | ±0.20         | ±0.30  | 5.0%      |                  | (I)        |
|      | C3216X5R106□EPS   | C3216X5R106□EP  | 1V, 1kHz            | 10          | uF   | ±10%, ±20%          | 1.60        | ±0.20         | ±0.30  | 10.0%     |                  | (II)       |
|      | C3216X5R226□EPS   | C3216X5R226□EP  | 0.5V, 120Hz         | 22          | uF   | ±10%, ±20%          | 1.60        | ±0.20         | ±0.30  | 10.0%     |                  | (II)       |
|      | C3216X5R226□METSE | C3216X5R226□MET | 0.5V, 120Hz         | 22          | uF   | ±20%                | 0.85        | ±0.20         | ±0.20  | 10.0%     | Paper, 4Kpcs     | (II)*      |
|      | C3216X5R476MEPS   | C3216X5R476MEP  | 0.5V, 120Hz         | 47          | uF   | ±20%                | 1.60        | ±0.30         | ±0.30  | 10.0%     | Embossed, 2Kpcs  | (II)       |
| 10V  | C3216X5R225□DPS   | C3216X5R225□DP  | 1V, 1kHz            | 2.2         | uF   | ±10%, ±20%          | 1.60        | ±0.20         | ±0.30  | 7.5%      | Embossed, 2Kpcs  | (I)        |
|      | C3216X5R475□DPS   | C3216X5R475□DP  | 1V, 1kHz            | 4.7         | uF   | ±10%, ±20%          | 1.60        | ±0.20         | ±0.30  | 7.5%      |                  | (I)        |
|      | C3216X5R106□DPS   | C3216X5R106□DP  | 1V, 1kHz            | 10          | uF   | ±10%, ±20%          | 1.60        | ±0.20         | ±0.30  | 10.0%     |                  | (II)       |
|      | C3216X5R226□DPS   | C3216X5R226□DP  | 0.5V, 120Hz         | 22          | uF   | ±10%, ±20%          | 1.60        | ±0.20         | ±0.30  | 10.0%     |                  | (II)       |
|      | C3216X5R226□MDTSE | C3216X5R226□MDT | 0.5V, 120Hz         | 22          | uF   | ±20%                | 0.85        | ±0.20         | ±0.20  | 10.0%     | Paper, 4Kpcs     | (II)*      |
|      | C3216X5R476□DPS   | C3216X5R476□DP  | 0.5V, 120Hz         | 47          | uF   | ±10%, ±20%          | 1.60        | ±0.20         | ±0.30  | 10.0%     | Embossed, 2Kpcs  | (II)       |
| 6.3V | C3216X5R106KCPS   | C3216X5R106KCP  | 1V, 1kHz            | 10          | uF   | ±10%                | 1.60        | ±0.20         | ±0.30  | 15.0%     | Embossed, 2Kpcs  | (II)       |
|      | C3216X5R226□CPS   | C3216X5R226□CP  | 0.5V, 120Hz         | 22          | uF   | ±10%, ±20%          | 1.60        | ±0.20         | ±0.30  | 15.0%     |                  | (II)       |
|      | C3216X5R476MCPS   | C3216X5R476MCP  | 0.5V, 120Hz         | 47          | uF   | ±20%                | 1.60        | ±0.20         | ±0.20  | 10.0%     |                  | (II)       |
|      | C3216X5R107MCPS   | C3216X5R107MCP  | 0.5V, 120Hz         | 100         | uF   | ±20%                | 1.60        | ±0.30         | ±0.30  | 15.0%     |                  | (II)       |
| 4V   | C3216X5R106□BPS   | C3216X5R106□BP  | 0.5V, 120Hz         | 22          | uF   | ±10%, ±20%          | 1.60        | ±0.20         | ±0.30  | 15.0%     | Embossed, 2Kpcs  | (II)       |
|      | C3216X5R476MBPS   | C3216X5R476MBP  | 0.5V, 120Hz         | 47          | uF   | ±20%                | 1.60        | ±0.20         | ±0.30  | 15.0%     |                  | (II)       |
|      | C3216X5R107MBPS   | C3216X5R107MBP  | 0.5V, 120Hz         | 100         | uF   | ±20%                | 1.60        | ±0.30         | ±0.30  | 15.0%     |                  | (II)       |
|      | C3216X5R227MBPSL  | C3216X5R227MBP  | 0.5V, 120Hz         | 220         | uF   | ±20%                | 1.60        | ±0.30         | ±0.30  | 15.0%     |                  | (II)       |

### ● C3225X5R Series (EIA1210)

| RV              | DARFON P/N       | DARFON P/N 2    | Measuring Condition | Capacitance |      | Available Tolerance | Thick. (mm) | Tolerance(mm) |             | DF (max.) | Standard Packing  | Test Spec.      |
|-----------------|------------------|-----------------|---------------------|-------------|------|---------------------|-------------|---------------|-------------|-----------|-------------------|-----------------|
|                 |                  |                 |                     | Value       | Unit |                     |             | L/W           | Thick.      |           |                   |                 |
| 50V             | C3225X5R106□GPS  | C3225X5R106□GP  | 1V, 1kHz            | 10          | uF   | ±10%, ±20%          | 2.50        | ±0.30/±0.20   | ±0.20       | 5.0%      | Embossed, 1Kpcs   | (II)            |
| 35V             | C3225X5R106□NPS  | C3225X5R106□NP  | 1V, 1kHz            | 10          | uF   | ±10%, ±20%          | 2.50        | ±0.30/±0.20   | ±0.20       | 5.0%      | Embossed, 1Kpcs   | (I)             |
| 25V             | C3225X5R475□FWS  | C3225X5R475□FW  | 1V, 1kHz            | 4.7         | uF   | ±10%, ±20%          | 2.00        | ±0.30/±0.20   | ±0.20       | 10.0%     | Embossed, 1Kpcs   | (I)             |
|                 | C3225X5R106□FPS  | C3225X5R106□FP  | 1V, 1kHz            | 10          | uF   | ±10%, ±20%          | 2.00        | ±0.30/±0.20   | ±0.20       | 10.0%     | Embossed, 2Kpcs   | (I)             |
| 16V             | C3225X5R226□FPS  | C3225X5R226□FP  | 0.5V, 120Hz         | 22          | uF   | ±10%, ±20%          | 2.50        | ±0.30/±0.20   | ±0.20       | 10.0%     | Embossed, 1Kpcs   | (II)            |
|                 | C3225X5R475□EWS  | C3225X5R475□EW  | 1V, 1kHz            | 4.7         | uF   | ±10%, ±20%          | 2.00        | ±0.30/±0.20   | ±0.20       | 5.0%      | Embossed, 1Kpcs   | (I)             |
|                 | C3225X5R106□EPS  | C3225X5R106□EP  | 1V, 1kHz            | 10          | uF   | ±10%, ±20%          | 2.00        | ±0.30/±0.20   | ±0.20       | 5.0%      | Embossed, 2Kpcs   | (I)             |
|                 | C3225X5R226□EWS  | C3225X5R226□EW  | 0.5V, 120Hz         | 22          | uF   | ±10%, ±20%          | 2.50        | ±0.30/±0.20   | ±0.20       | 15.0%     | Embossed, 0.5Kpcs | (II)            |
|                 | C3225X5R226□EPS  | C3225X5R226□EP  | 0.5V, 120Hz         | 22          | uF   | ±10%, ±20%          | 2.50        | ±0.30/±0.20   | ±0.20       | 15.0%     | Embossed, 1Kpcs   | (II)            |
|                 | C3225X5R476MEPSS | C3225X5R476MEP  | 0.5V, 120Hz         | 47          | uF   | ±20%                | 1.90        | ±0.30/±0.20   | +0.1/-0.2   | 15.0%     | Embossed, 2Kpcs   | (II)            |
|                 | C3225X5R476□EWS  | C3225X5R476□EW  | 0.5V, 120Hz         | 47          | uF   | ±10%, ±20%          | 2.50        | ±0.30/±0.20   | ±0.20       | 15.0%     | Embossed, 0.5Kpcs | (II)            |
|                 | C3225X5R476□EPS  | C3225X5R476□EP  | 0.5V, 120Hz         | 47          | uF   | ±10%, ±20%          | 2.50        | ±0.30/±0.20   | ±0.20       | 15.0%     | Embossed, 1Kpcs   | (II)            |
|                 | C3225X5R107MEPS  | C3225X5R107MEP  | 0.5V, 120Hz         | 100         | uF   | ±20%                | 2.50        | ±0.30         | ±0.30       | 10.0%     |                   | (II)            |
|                 | 10V              | C3225X5R226□DPS | C3225X5R226□DP      | 0.5V, 120Hz | 22   | uF                  | ±10%, ±20%  | 2.50          | ±0.30/±0.20 | ±0.20     | 10.0%             | Embossed, 1Kpcs |
| C3225X5R476□DPS |                  | C3225X5R476□DP  | 0.5V, 120Hz         | 47          | uF   | ±10%, ±20%          | 2.50        | ±0.30/±0.20   | ±0.20       | 10.0%     | (II)              |                 |
| C3225X5R107MDPS |                  | C3225X5R107MDP  | 0.5V, 120Hz         | 100         | uF   | ±20%                | 2.50        | ±0.30/±0.20   | ±0.30       | 10.0%     | (II)              |                 |
| 6.3V            | C3225X5R226□CPS  | C3225X5R226□CP  | 0.5V, 120Hz         | 22          | uF   | ±10%, ±20%          | 2.50        | ±0.30/±0.20   | ±0.20       | 10.0%     | Embossed, 1Kpcs   | (II)            |
|                 | C3225X5R476□CPS  | C3225X5R476□CP  | 0.5V, 120Hz         | 47          | uF   | ±10%, ±20%          | 2.50        | ±0.30/±0.20   | ±0.20       | 15.0%     |                   | (II)            |
|                 | C3225X5R107MCPS  | C3225X5R107MCP  | 0.5V, 120Hz         | 100         | uF   | ±20%                | 2.50        | ±0.30         | ±0.30       | 15.0%     |                   | (II)            |

### ● C4532X5R Series (EIA1812)

| RV  | DARFON P/N      | DARFON P/N 2   | Measuring Condition | Capacitance |      | Available Tolerance | Thick. (mm) | Tolerance(mm) |        | DF (max.) | Standard Packing | Test Spec. |
|-----|-----------------|----------------|---------------------|-------------|------|---------------------|-------------|---------------|--------|-----------|------------------|------------|
|     |                 |                |                     | Value       | Unit |                     |             | L/W           | Thick. |           |                  |            |
| 50V | C4532X5R225KGPS | C4532X5R225KGP | 1V, 1kHz            | 2.2         | uF   | ±10%                | 1.60        | ±0.30         | ±0.20  | 10.0%     | Embossed, 1Kpcs  | (II)*      |

□ Tolerance Code: K=±10%, M=±20% ;Special tolerance on the request.;

(II)\* High temperature load life test are applicable in rated voltage \*100%



■ X6S Series

● C0603X6S Series (EIA0201)

| RV   | DARFON P/N      | DARFON P/N 2   | Measuring Condition | Capacitance |      | Available Tolerance | Thick. (mm) | Tolerance(mm) |        | DF (max.) | Standard Packing | Test Spec. |
|------|-----------------|----------------|---------------------|-------------|------|---------------------|-------------|---------------|--------|-----------|------------------|------------|
|      |                 |                |                     | Value       | Unit |                     |             | L/W           | Thick. |           |                  |            |
| 25V  | C0603X6S103KFTS | C0603X6S103KFT | 1V, 1kHz            | 10          | nF   | ±10%                | 0.30        | ±0.03         | ±0.03  | 5.0%      | Paper, 15Kpcs    | (I)        |
|      | C0603X6S104KFTS | C0603X6S104KFT | 1V, 1kHz            | 100         | nF   | ±10%                | 0.30        | ±0.03         | ±0.03  | 10.0%     |                  | (II)*      |
| 16V  | C0603X6S103KETs | C0603X6S103KET | 1V, 1kHz            | 10          | nF   | ±10%                | 0.30        | ±0.03         | ±0.03  | 5.0%      | Paper, 15Kpcs    | (I)        |
|      | C0603X6S104□ETS | C0603X6S104□ET | 1V, 1kHz            | 100         | nF   | ±10%, ±20%          | 0.30        | ±0.03         | ±0.03  | 10.0%     |                  | (II)       |
| 10V  | C0603X6S104KDTS | C0603X6S104KDT | 1V, 1kHz            | 100         | nF   | ±10%                | 0.30        | ±0.03         | ±0.03  | 10.0%     | Paper, 15Kpcs    | (II)       |
|      | C0603X6S224□DTS | C0603X6S224□DT | 0.5V, 1kHz          | 220         | nF   | ±10%, ±20%          | 0.30        | ±0.03         | ±0.03  | 10.0%     |                  | (II)       |
| 6.3V | C0603X6S103□CTS | C0603X6S103□CT | 1V, 1kHz            | 10          | nF   | ±10%, ±20%          | 0.30        | ±0.03         | ±0.03  | 5.0%      | Paper, 15Kpcs    | (I)        |
|      | C0603X6S473□CTS | C0603X6S473□CT | 1V, 1kHz            | 47          | nF   | ±10%, ±20%          | 0.30        | ±0.03         | ±0.03  | 10.0%     |                  | (I)        |
|      | C0603X6S104□CTS | C0603X6S104□CT | 1V, 1kHz            | 100         | nF   | ±10%, ±20%          | 0.30        | ±0.03         | ±0.03  | 10.0%     |                  | (II)*      |
|      | C0603X6S224□CTS | C0603X6S224□CT | 0.5V, 1kHz          | 220         | nF   | ±10%, ±20%          | 0.30        | ±0.03         | ±0.03  | 10.0%     |                  | (II)*      |
|      | C0603X6S105MCTS | C0603X6S105MCT | 0.5V, 1kHz          | 1           | uF   | ±20%                | 0.30        | ±0.09         | ±0.09  | 10.0%     |                  | (II)*      |
| 4V   | C0603X6S104□BTS | C0603X6S104□BT | 0.5V, 1kHz          | 100         | nF   | ±10%, ±20%          | 0.30        | ±0.03         | ±0.03  | 10.0%     | Paper, 15Kpcs    | (II)       |
|      | C0603X6S224□BTS | C0603X6S224□BT | 0.5V, 1kHz          | 220         | nF   | ±10%, ±20%          | 0.30        | ±0.03         | ±0.03  | 10.0%     |                  | (II)       |
|      | C0603X6S474MBTS | C0603X6S474MBT | 0.5V, 1kHz          | 470         | nF   | ±20%                | 0.30        | ±0.03         | ±0.03  | 10.0%     |                  | (II)       |
|      | C0603X6S105MBTS | C0603X6S105MBT | 0.5V, 1kHz          | 1           | uF   | ±20%                | 0.30        | ±0.09         | ±0.09  | 10.0%     |                  | (II)*      |

● C1005X6S Series (EIA0402)

| RV   | DARFON P/N      | DARFON P/N 2   | Measuring Condition | Capacitance |      | Available Tolerance | Thick. (mm) | Tolerance(mm) |        | DF (max.) | Standard Packing | Test Spec. |
|------|-----------------|----------------|---------------------|-------------|------|---------------------|-------------|---------------|--------|-----------|------------------|------------|
|      |                 |                |                     | Value       | Unit |                     |             | L/W           | Thick. |           |                  |            |
| 25V  | C1005X6S104KFTS | C1005X6S104KFT | 1V, 1kHz            | 100         | nF   | ±10%                | 0.50        | ±0.05         | ±0.05  | 10.0%     | Paper, 10Kpcs    | (II)       |
|      | C1005X6S224KFTS | C1005X6S224KFT | 1V, 1kHz            | 220         | nF   | ±10%                | 0.50        | ±0.05         | ±0.05  | 10.0%     |                  | (II)       |
|      | C1005X6S105□FTS | C1005X6S105□FT | 0.5V, 1kHz          | 1.0         | uF   | ±10%, ±20%          | 0.50        | ±0.10         | ±0.10  | 10.0%     |                  | (II)*      |
| 16V  | C1005X6S224KETs | C1005X6S224KET | 1V, 1kHz            | 220         | nF   | ±10%                | 0.50        | ±0.05         | ±0.05  | 10.0%     | Paper, 10Kpcs    | (II)       |
|      | C1005X6S105□ETS | C1005X6S105□ET | 0.5V, 1kHz          | 1.0         | uF   | ±10%, ±20%          | 0.50        | ±0.10         | ±0.10  | 12.5%     | Paper, 10Kpcs    | (II)*      |
|      | C1005X6S225METS | C1005X6S225MET | 1V, 1kHz            | 2.2         | uF   | ±20%                | 0.50        | ±0.20         | ±0.20  | 10.0%     | Paper, 10Kpcs    | (II)       |
| 10V  | C1005X6S105□DTS | C1005X6S105□DT | 0.5V, 1kHz          | 1.0         | uF   | ±10%, ±20%          | 0.50        | ±0.05         | ±0.05  | 12.5%     | Paper, 10Kpcs    | (II)*      |
|      | C1005X6S225□DTS | C1005X6S225□DT | 1V, 1kHz            | 2.2         | uF   | ±10%, ±20%          | 0.50        | ±0.20         | ±0.20  | 10.0%     | Paper, 10Kpcs    | (II)       |
| 6.3V | C1005X6S224KCTS | C1005X6S224KCT | 1V, 1kHz            | 220         | nF   | ±10%                | 0.50        | ±0.05         | ±0.05  | 10.0%     | Paper, 10Kpcs    | (II)       |
|      | C1005X6S105□CTS | C1005X6S105□CT | 0.5V, 1kHz          | 1.0         | uF   | ±10%, ±20%          | 0.50        | ±0.05         | ±0.05  | 10.0%     |                  | (II)*      |
|      | C1005X6S225□CTS | C1005X6S225□CT | 0.5V, 1kHz          | 2.2         | uF   | ±10%, ±20%          | 0.50        | ±0.05         | ±0.05  | 10.0%     |                  | (II)*      |
|      | C1005X6S475MCTS | C1005X6S475MCT | 0.5V, 1kHz          | 4.7         | uF   | ±20%                | 0.50        | ±0.15         | ±0.15  | 10.0%     |                  | (II)*      |
|      | C1005X6S106MCTS | C1005X6S106MCT | 0.5V, 1kHz          | 10          | uF   | ±20%                | 0.50        | ±0.20         | ±0.20  | 10.0%     |                  | (II)*      |
| 4V   | C1005X6S106MBTS | C1005X6S106MBT | 0.5V, 1kHz          | 10          | uF   | ±20%                | 0.50        | ±0.20         | ±0.20  | 10.0%     | Paper, 10Kpcs    | (II)*      |

● C1608X6S Series (EIA0603)

| RV   | DARFON P/N      | DARFON P/N 2   | Measuring Condition | Capacitance |      | Available Tolerance | Thick. (mm) | Tolerance(mm) |        | DF (max.) | Standard Packing | Test Spec. |
|------|-----------------|----------------|---------------------|-------------|------|---------------------|-------------|---------------|--------|-----------|------------------|------------|
|      |                 |                |                     | Value       | Unit |                     |             | L/W           | Thick. |           |                  |            |
| 25V  | C1608X6S475□FTS | C1608X6S475□FT | 1V, 1kHz            | 4.7         | uF   | ±10%, ±20%          | 0.80        | ±0.20         | ±0.20  | 10.0%     | Paper, 4Kpcs     | (II)*      |
| 16V  | C1608X6S105KETs | C1608X6S105KET | 1V, 1kHz            | 1.0         | uF   | ±10%                | 0.80        | ±0.15         | ±0.15  | 10.0%     | Paper, 4Kpcs     | (II)       |
|      | C1608X6S225KETs | C1608X6S225KET | 1V, 1kHz            | 2.2         | uF   | ±10%                | 0.80        | ±0.10         | ±0.10  | 10.0%     |                  | (II)       |
|      | C1608X6S475KETs | C1608X6S475KET | 1V, 1kHz            | 4.7         | uF   | ±10%                | 0.80        | ±0.20         | ±0.20  | 10.0%     |                  | (II)       |
|      | C1608X6S106METS | C1608X6S106MET | 1V, 1kHz            | 10          | uF   | ±20%                | 0.80        | ±0.20         | ±0.20  | 10.0%     |                  | (II)       |
| 10V  | C1608X6S225DTS  | C1608X6S225KDT | 1V, 1kHz            | 2.2         | uF   | ±10%                | 0.80        | ±0.10         | ±0.10  | 10.0%     | Paper, 4Kpcs     | (II)       |
|      | C1608X6S475KDTS | C1608X6S475KDT | 1V, 1kHz            | 4.7         | uF   | ±10%                | 0.80        | ±0.15         | ±0.15  | 10.0%     |                  | (II)       |
|      | C1608X6S106MDTS | C1608X6S106MDT | 1V, 1kHz            | 10          | uF   | ±20%                | 0.80        | ±0.20         | ±0.20  | 10.0%     |                  | (II)       |
| 6.3V | C1608X6S475□CTS | C1608X6S475□CT | 1V, 1kHz            | 4.7         | uF   | ±10%, ±20%          | 0.80        | ±0.10         | ±0.10  | 10.0%     | Paper, 4Kpcs     | (II)*      |
|      | C1608X6S106MCTS | C1608X6S106MCT | 0.5V, 120Hz         | 10          | uF   | ±20%                | 0.80        | ±0.20         | ±0.20  | 10.0%     |                  | (II)       |
|      | C1608X6S226MCTS | C1608X6S226MCT | 0.5V, 120Hz         | 22          | uF   | ±20%                | 0.80        | ±0.20         | ±0.20  | 10.0%     |                  | (II)*      |
| 4V   | C1608X6S106MBTS | C1608X6S106MBT | 0.5V, 120Hz         | 10          | uF   | ±20%                | 0.80        | ±0.20         | ±0.20  | 10.0%     | Paper, 4Kpcs     | (II)       |
|      | C1608X6S226MBTS | C1608X6S226MBT | 0.5V, 120Hz         | 22          | uF   | ±20%                | 0.80        | ±0.20         | ±0.20  | 10.0%     |                  | (II)*      |

MLCC  
General Purpose



● C2012X6S Series (EIA0805)

| RV   | DARFON P/N      | DARFON P/N 2   | Measuring Condition | Capacitance |      | Available Tolerance | Thick. (mm) | Tolerance(mm) |        | DF (max.) | Standard Packing | Test Spec. |
|------|-----------------|----------------|---------------------|-------------|------|---------------------|-------------|---------------|--------|-----------|------------------|------------|
|      |                 |                |                     | Value       | Unit |                     |             | L/W           | Thick. |           |                  |            |
| 50V  | C2012X6S475KGPS | C2012X6S475KGP | 1V , 1kHz           | 4.7         | uF   | ±10%                | 1.25        | ±0.20         | ±0.20  | 10.0%     | Embossed, 3Kpcs  | (II)       |
| 25V  | C2012X6S106KFPS | C2012X6S106KFP | 0.5V , 1kHz         | 10          | uF   | ±10%                | 1.25        | ±0.15         | ±0.20  | 12.5%     | Embossed, 3Kpcs  | (II)*      |
| 16V  | C2012X6S106KEPS | C2012X6S106KEP | 1V , 1kHz           | 10          | uF   | ±10%                | 1.25        | ±0.15         | ±0.15  | 10.0%     | Embossed, 3Kpcs  | (II)       |
|      | C2012X6S226MEPS | C2012X6S226MEP | 0.5V , 120Hz        | 22          | uF   | ±20%                | 1.25        | ±0.20         | ±0.20  | 10.0%     |                  | (II)*      |
| 10V  | C2012X6S106KDPS | C2012X6S106KDP | 0.5V , 1kHz         | 10          | uF   | ±10%                | 1.25        | ±0.15         | ±0.15  | 10.0%     | Embossed, 3Kpcs  | (II)*      |
|      | C2012X6S226MDPS | C2012X6S226MDP | 0.5V , 120Hz        | 22          | uF   | ±20%                | 1.25        | ±0.20         | ±0.20  | 10.0%     |                  | (II)       |
| 6.3V | C2012X6S106MCPS | C2012X6S106MCP | 0.5V , 1kHz         | 10          | uF   | ±20%                | 1.25        | ±0.15         | ±0.15  | 10.0%     | Embossed, 3Kpcs  | (II)*      |
|      | C2012X6S226MCPS | C2012X6S226MCP | 0.5V , 120Hz        | 22          | uF   | ±20%                | 1.25        | ±0.15         | ±0.15  | 10.0%     |                  | (II)*      |
| 4V   | C2012X6S106MBPS | C2012X6S106MBP | 0.5V , 1kHz         | 10          | uF   | ±20%                | 1.25        | ±0.15         | ±0.15  | 10.0%     | Embossed, 3Kpcs  | (II)       |
|      | C2012X6S226MBPS | C2012X6S226MBP | 0.5V , 120Hz        | 22          | uF   | ±20%                | 1.25        | ±0.15         | ±0.15  | 10.0%     |                  | (II)       |
|      | C2012X6S476MBPS | C2012X6S476MBP | 0.5V , 120Hz        | 47          | uF   | ±20%                | 1.25        | ±0.20         | ±0.20  | 10.0%     |                  | (II)*      |
|      | C2012X6S107MBPS | C2012X6S107MBP | 0.5V , 120Hz        | 100         | uF   | ±20%                | 1.25        | ±0.20         | ±0.20  | 10.0%     |                  | (II)*      |

● C3216X6S Series (EIA1206)

| RV   | DARFON P/N      | DARFON P/N 2   | Measuring Condition | Capacitance |      | Available Tolerance | Thick. (mm) | Tolerance(mm) |        | DF (max.) | Standard Packing | Test Spec. |
|------|-----------------|----------------|---------------------|-------------|------|---------------------|-------------|---------------|--------|-----------|------------------|------------|
|      |                 |                |                     | Value       | Unit |                     |             | L/W           | Thick. |           |                  |            |
| 35V  | C3216X6S106KNPS | C3216X6S106KNP | 1V , 1kHz           | 10          | uF   | ±10%                | 1.60        | ±0.20         | ±0.20  | 10.0%     | Embossed, 2Kpcs  | (II)       |
| 25V  | C3216X6S106KFPS | C3216X6S106KFP | 1V , 1kHz           | 10          | uF   | ±10%                | 1.60        | ±0.20         | ±0.20  | 10.0%     | Embossed, 2Kpcs  | (II)       |
|      | C3216X6S226□FPS | C3216X6S226□FP | 0.5V , 120Hz        | 22          | uF   | ±10%,±20%           | 1.60        | ±0.30         | ±0.30  | 10.0%     |                  | (II)       |
| 16V  | C3216X6S226MEPS | C3216X6S226MEP | 0.5V , 120Hz        | 22          | uF   | ±20%                | 1.60        | ±0.20         | ±0.20  | 10.0%     | Embossed, 2Kpcs  | (II)       |
| 10V  | C3216X6S476MDPS | C3216X6S476MDP | 0.5V , 120Hz        | 47          | uF   | ±20%                | 1.60        | ±0.30         | ±0.30  | 10.0%     | Embossed, 2Kpcs  | (II)       |
| 6.3V | C3216X6S476MCPS | C3216X6S476MCP | 0.5V , 120Hz        | 47          | uF   | ±20%                | 1.60        | ±0.20         | ±0.20  | 10.0%     | Embossed, 2Kpcs  | (II)       |
| 4V   | C3216X6S226MBTS | C3216X6S226MBT | 0.5V , 120Hz        | 22          | uF   | ±20%                | 0.85        | ±0.20         | ±0.10  | 10.0%     | Paper, 4Kpcs     | (II)       |
|      | C3216X6S107MBPS | C3216X6S107MBP | 0.5V , 120Hz        | 100         | uF   | ±20%                | 1.60        | ±0.20         | ±0.20  | 10.0%     | Embossed, 2Kpcs  | (II)       |

● C3225X6S Series (EIA1210)

| RV   | DARFON P/N      | DARFON P/N 2   | Measuring Condition | Capacitance |      | Available Tolerance | Thick. (mm) | Tolerance(mm) |        | DF (max.) | Standard Packing | Test Spec. |
|------|-----------------|----------------|---------------------|-------------|------|---------------------|-------------|---------------|--------|-----------|------------------|------------|
|      |                 |                |                     | Value       | Unit |                     |             | L/W           | Thick. |           |                  |            |
| 16V  | C3225X6S476MEPS | C3225X6S476MEP | 0.5V , 120Hz        | 47          | uF   | ±20%                | 2.50        | ±0.30         | ±0.20  | 10.0%     | Embossed, 1Kpcs  | (II)*      |
| 6.3V | C3225X6S107MCPS | C3225X6S107MCP | 0.5V , 120Hz        | 100         | uF   | ±20%                | 2.50        | ±0.30         | ±0.30  | 10.0%     | Embossed, 1Kpcs  | (II)       |

□ Tolerance Code: K=±10%, M=±20% ;Special tolerance on the request.;

(II)\* High temperature load life test are applicable in rated voltage \*100%

- X7R Series
- C0603X7R Series(EIA0201)

| RV               | DARFON P/N       | DARFON P/N 2   | Measuring Condition | Capacitance |      | Available Tolerance | Thick. (mm) | Tolerance(mm) |        | DF (max.) | Standard Packing | Test Spec. |
|------------------|------------------|----------------|---------------------|-------------|------|---------------------|-------------|---------------|--------|-----------|------------------|------------|
|                  |                  |                |                     | Value       | Unit |                     |             | L/W           | Thick. |           |                  |            |
| 50V              | C0603X7R101□GTS  | C0603X7R101□GT | 1V, 1kHz            | 100         | pF   | ±10%, ±5%           | 0.30        | ±0.03         | ±0.03  | 3.0%      | Paper, 15Kpcs    | (f)        |
|                  | C0603X7R121KGTS  | C0603X7R121KGT | 1V, 1kHz            | 120         | pF   | ±10%                | 0.30        | ±0.03         | ±0.03  | 3.0%      |                  | (f)        |
|                  | C0603X7R151KGTS  | C0603X7R151KGT | 1V, 1kHz            | 150         | pF   | ±10%                | 0.30        | ±0.03         | ±0.03  | 3.0%      |                  | (f)        |
|                  | C0603X7R181KGTS  | C0603X7R181KGT | 1V, 1kHz            | 180         | pF   | ±10%                | 0.30        | ±0.03         | ±0.03  | 3.0%      |                  | (f)        |
|                  | C0603X7R221□GTS  | C0603X7R221□GT | 1V, 1kHz            | 220         | pF   | ±10%, ±5%           | 0.30        | ±0.03         | ±0.03  | 3.0%      |                  | (f)        |
|                  | C0603X7R271KGTS  | C0603X7R271KGT | 1V, 1kHz            | 270         | pF   | ±10%                | 0.30        | ±0.03         | ±0.03  | 3.0%      |                  | (f)        |
|                  | C0603X7R331KGTS  | C0603X7R331KGT | 1V, 1kHz            | 330         | pF   | ±10%                | 0.30        | ±0.03         | ±0.03  | 3.0%      |                  | (f)        |
|                  | C0603X7R391KGTS  | C0603X7R391KGT | 1V, 1kHz            | 390         | pF   | ±10%                | 0.30        | ±0.03         | ±0.03  | 3.0%      |                  | (f)        |
|                  | C0603X7R471KGTS  | C0603X7R471KGT | 1V, 1kHz            | 470         | pF   | ±10%                | 0.30        | ±0.03         | ±0.03  | 3.0%      |                  | (f)        |
|                  | C0603X7R561KGTS  | C0603X7R561KGT | 1V, 1kHz            | 560         | pF   | ±10%                | 0.30        | ±0.03         | ±0.03  | 3.0%      |                  | (f)        |
|                  | C0603X7R681□GTS  | C0603X7R681□GT | 1V, 1kHz            | 680         | pF   | ±10%, ±5%           | 0.30        | ±0.03         | ±0.03  | 3.0%      |                  | (f)        |
|                  | C0603X7R821KGTS  | C0603X7R821KGT | 1V, 1kHz            | 820         | pF   | ±10%                | 0.30        | ±0.03         | ±0.03  | 3.0%      |                  | (f)        |
|                  | C0603X7R102KGTS  | C0603X7R102KGT | 1V, 1kHz            | 1.0         | nF   | ±10%                | 0.30        | ±0.03         | ±0.03  | 3.0%      |                  | (f)        |
|                  | C0603X7R122KGTS  | C0603X7R122KGT | 1V, 1kHz            | 1.2         | nF   | ±10%                | 0.30        | ±0.03         | ±0.03  | 3.0%      |                  | (f)        |
|                  | C0603X7R152KGTS  | C0603X7R152KGT | 1V, 1kHz            | 1.5         | nF   | ±10%                | 0.30        | ±0.03         | ±0.03  | 3.0%      |                  | (f)        |
| C0603X7R182KGTS  | C0603X7R182KGT   | 1V, 1kHz       | 1.8                 | nF          | ±10% | 0.30                | ±0.03       | ±0.03         | 3.0%   | (f)       |                  |            |
| C0603X7R222KGTS  | C0603X7R222KGT   | 1V, 1kHz       | 2.2                 | nF          | ±10% | 0.30                | ±0.03       | ±0.03         | 3.0%   | (f)       |                  |            |
| 25V              | C0603X7R101KFSTS | C0603X7R101KFT | 1V, 1kHz            | 100         | pF   | ±10%                | 0.30        | ±0.03         | ±0.03  | 3.5%      | Paper, 15Kpcs    | (f)        |
|                  | C0603X7R121KFSTS | C0603X7R121KFT | 1V, 1kHz            | 120         | pF   | ±10%                | 0.30        | ±0.03         | ±0.03  | 3.5%      |                  | (f)        |
|                  | C0603X7R151KFSTS | C0603X7R151KFT | 1V, 1kHz            | 150         | pF   | ±10%                | 0.30        | ±0.03         | ±0.03  | 3.5%      |                  | (f)        |
|                  | C0603X7R181KFSTS | C0603X7R181KFT | 1V, 1kHz            | 180         | pF   | ±10%                | 0.30        | ±0.03         | ±0.03  | 3.5%      |                  | (f)        |
|                  | C0603X7R221KFSTS | C0603X7R221KFT | 1V, 1kHz            | 220         | pF   | ±10%                | 0.30        | ±0.03         | ±0.03  | 3.5%      |                  | (f)        |
|                  | C0603X7R271KFSTS | C0603X7R271KFT | 1V, 1kHz            | 270         | pF   | ±10%                | 0.30        | ±0.03         | ±0.03  | 3.5%      |                  | (f)        |
|                  | C0603X7R331KFSTS | C0603X7R331KFT | 1V, 1kHz            | 330         | pF   | ±10%                | 0.30        | ±0.03         | ±0.03  | 3.5%      |                  | (f)        |
|                  | C0603X7R391KFSTS | C0603X7R391KFT | 1V, 1kHz            | 390         | pF   | ±10%                | 0.30        | ±0.03         | ±0.03  | 3.5%      |                  | (f)        |
|                  | C0603X7R471□FSTS | C0603X7R471□FT | 1V, 1kHz            | 470         | pF   | ±10%, ±5%           | 0.30        | ±0.03         | ±0.03  | 3.5%      |                  | (f)        |
|                  | C0603X7R561KFSTS | C0603X7R561KFT | 1V, 1kHz            | 560         | pF   | ±10%                | 0.30        | ±0.03         | ±0.03  | 3.5%      |                  | (f)        |
|                  | C0603X7R681KFSTS | C0603X7R681KFT | 1V, 1kHz            | 680         | pF   | ±10%                | 0.30        | ±0.03         | ±0.03  | 3.5%      |                  | (f)        |
|                  | C0603X7R821KFSTS | C0603X7R821KFT | 1V, 1kHz            | 820         | pF   | ±10%                | 0.30        | ±0.03         | ±0.03  | 3.5%      |                  | (f)        |
|                  | C0603X7R102KFSTS | C0603X7R102KFT | 1V, 1kHz            | 1.0         | nF   | ±10%                | 0.30        | ±0.03         | ±0.03  | 3.5%      |                  | (f)        |
|                  | C0603X7R122KFSTS | C0603X7R122KFT | 1V, 1kHz            | 1.2         | nF   | ±10%                | 0.30        | ±0.03         | ±0.03  | 3.5%      |                  | (f)        |
|                  | C0603X7R152KFSTS | C0603X7R152KFT | 1V, 1kHz            | 1.5         | nF   | ±10%                | 0.30        | ±0.03         | ±0.03  | 3.5%      |                  | (f)        |
| C0603X7R182KFSTS | C0603X7R182KFT   | 1V, 1kHz       | 1.8                 | nF          | ±10% | 0.30                | ±0.03       | ±0.03         | 3.5%   | (f)       |                  |            |
| C0603X7R222KFSTS | C0603X7R222KFT   | 1V, 1kHz       | 2.2                 | nF          | ±10% | 0.30                | ±0.03       | ±0.03         | 3.5%   | (f)       |                  |            |
| C0603X7R332KFSTS | C0603X7R332KFT   | 1V, 1kHz       | 3.3                 | nF          | ±10% | 0.30                | ±0.03       | ±0.03         | 5.0%   | (f)       |                  |            |
| C0603X7R682KFSTS | C0603X7R682KFT   | 1V, 1kHz       | 6.8                 | nF          | ±10% | 0.30                | ±0.03       | ±0.03         | 5.0%   | (f)       |                  |            |
| C0603X7R103KFSTS | C0603X7R103KFT   | 1V, 1kHz       | 10                  | nF          | ±10% | 0.30                | ±0.03       | ±0.03         | 5.0%   | (f)       |                  |            |
| 16V              | C0603X7R101KETS  | C0603X7R101KET | 1V, 1kHz            | 100         | pF   | ±10%                | 0.30        | ±0.03         | ±0.03  | 3.5%      | Paper, 15Kpcs    | (f)        |
|                  | C0603X7R221KETS  | C0603X7R221KET | 1V, 1kHz            | 220         | pF   | ±10%                | 0.30        | ±0.03         | ±0.03  | 3.5%      |                  | (f)        |
|                  | C0603X7R331KETS  | C0603X7R331KET | 1V, 1kHz            | 330         | pF   | ±10%                | 0.30        | ±0.03         | ±0.03  | 3.5%      |                  | (f)        |
|                  | C0603X7R471KETS  | C0603X7R471KET | 1V, 1kHz            | 470         | pF   | ±10%                | 0.30        | ±0.03         | ±0.03  | 3.5%      |                  | (f)        |
|                  | C0603X7R681□ETS  | C0603X7R681□ET | 1V, 1kHz            | 680         | pF   | ±10%, ±5%           | 0.30        | ±0.03         | ±0.03  | 3.5%      |                  | (f)        |
|                  | C0603X7R821□ETS  | C0603X7R821□ET | 1V, 1kHz            | 820         | pF   | ±10%, ±5%           | 0.30        | ±0.03         | ±0.03  | 3.5%      |                  | (f)        |
|                  | C0603X7R102□ETS  | C0603X7R102□ET | 1V, 1kHz            | 1.0         | nF   | ±10%, ±5%           | 0.30        | ±0.03         | ±0.03  | 3.5%      |                  | (f)        |
|                  | C0603X7R152□ETS  | C0603X7R152□ET | 1V, 1kHz            | 1.5         | nF   | ±10%, ±5%           | 0.30        | ±0.03         | ±0.03  | 3.5%      |                  | (f)        |
|                  | C0603X7R222KETS  | C0603X7R222KET | 1V, 1kHz            | 2.2         | nF   | ±10%                | 0.30        | ±0.03         | ±0.03  | 3.5%      |                  | (f)        |
|                  | C0603X7R272□ETS  | C0603X7R272□ET | 1V, 1kHz            | 2.7         | nF   | ±10%, ±5%           | 0.30        | ±0.03         | ±0.03  | 5.0%      |                  | (f)        |
|                  | C0603X7R332KETS  | C0603X7R332KET | 1V, 1kHz            | 3.3         | nF   | ±10%                | 0.30        | ±0.03         | ±0.03  | 5.0%      |                  | (f)        |
|                  | C0603X7R392KETS  | C0603X7R392KET | 1V, 1kHz            | 3.9         | nF   | ±10%                | 0.30        | ±0.03         | ±0.03  | 5.0%      |                  | (f)        |
|                  | C0603X7R472KETS  | C0603X7R472KET | 1V, 1kHz            | 4.7         | nF   | ±10%                | 0.30        | ±0.03         | ±0.03  | 5.0%      |                  | (f)        |
|                  | C0603X7R562KETS  | C0603X7R562KET | 1V, 1kHz            | 5.6         | nF   | ±10%                | 0.30        | ±0.03         | ±0.03  | 5.0%      |                  | (f)        |
|                  | C0603X7R682KETS  | C0603X7R682KET | 1V, 1kHz            | 6.8         | nF   | ±10%                | 0.30        | ±0.03         | ±0.03  | 5.0%      |                  | (f)        |
| C0603X7R822KETS  | C0603X7R822KET   | 1V, 1kHz       | 8.2                 | nF          | ±10% | 0.30                | ±0.03       | ±0.03         | 5.0%   | (f)       |                  |            |
| C0603X7R103KETS  | C0603X7R103KET   | 1V, 1kHz       | 10                  | nF          | ±10% | 0.30                | ±0.03       | ±0.03         | 5.0%   | (f)       |                  |            |
| 10V              | C0603X7R182KDSTS | C0603X7R182KDT | 1V, 1kHz            | 1.8         | nF   | ±10%                | 0.30        | ±0.03         | ±0.03  | 5.0%      | Paper, 15Kpcs    | (f)        |
|                  | C0603X7R222KDSTS | C0603X7R222KDT | 1V, 1kHz            | 2.2         | nF   | ±10%                | 0.30        | ±0.03         | ±0.03  | 5.0%      |                  | (f)        |
|                  | C0603X7R272□DSTS | C0603X7R272□DT | 1V, 1kHz            | 2.7         | nF   | ±10%, ±5%           | 0.30        | ±0.03         | ±0.03  | 5.0%      |                  | (f)        |
|                  | C0603X7R332KDSTS | C0603X7R332KDT | 1V, 1kHz            | 3.3         | nF   | ±10%                | 0.30        | ±0.03         | ±0.03  | 5.0%      |                  | (f)        |
|                  | C0603X7R392KDSTS | C0603X7R392KDT | 1V, 1kHz            | 3.9         | nF   | ±10%                | 0.30        | ±0.03         | ±0.03  | 5.0%      |                  | (f)        |
|                  | C0603X7R472KDSTS | C0603X7R472KDT | 1V, 1kHz            | 4.7         | nF   | ±10%                | 0.30        | ±0.03         | ±0.03  | 5.0%      |                  | (f)        |
|                  | C0603X7R562KDSTS | C0603X7R562KDT | 1V, 1kHz            | 5.6         | nF   | ±10%                | 0.30        | ±0.03         | ±0.03  | 5.0%      |                  | (f)        |
|                  | C0603X7R682KDSTS | C0603X7R682KDT | 1V, 1kHz            | 6.8         | nF   | ±10%                | 0.30        | ±0.03         | ±0.03  | 5.0%      |                  | (f)        |
| C0603X7R822KDSTS | C0603X7R822KDT   | 1V, 1kHz       | 8.2                 | nF          | ±10% | 0.30                | ±0.03       | ±0.03         | 5.0%   | (f)       |                  |            |
| C0603X7R103KDSTS | C0603X7R103KDT   | 1V, 1kHz       | 10                  | nF          | ±10% | 0.30                | ±0.03       | ±0.03         | 5.0%   | (f)       |                  |            |
| 6.3V             | C0603X7R103KCTS  | C0603X7R103KCT | 1V, 1kHz            | 10          | nF   | ±10%                | 0.30        | ±0.03         | ±0.03  | 5.0%      | Paper, 15Kpcs    | (f)        |

□ Tolerance Code: J=±5%, K=±10%, M=±20%; Special tolerance on the request.

● C1005X7R Series (EIA0402)

| RV             | DARFON P/N      | DARFON P/N 2   | Measuring Condition | Capacitance |      | Available Tolerance | Thick. (mm) | Tolerance(mm) |        | DF (max.) | Standard Packing | Test Spec. |
|----------------|-----------------|----------------|---------------------|-------------|------|---------------------|-------------|---------------|--------|-----------|------------------|------------|
|                |                 |                |                     | Value       | Unit |                     |             | L/W           | Thick. |           |                  |            |
| 50V            | C1005X7R101□GTS | C1005X7R101□GT | 1V, 1kHz            | 100         | pF   | ±10%, ±5%           | 0.50        | ±0.05         | ±0.05  | 3.0%      | Paper, 10Kpcs    | (I)        |
|                | C1005X7R121KGT  | C1005X7R121KGT | 1V, 1kHz            | 120         | pF   | ±10%                | 0.50        | ±0.05         | ±0.05  | 3.0%      |                  | (I)        |
|                | C1005X7R151KGT  | C1005X7R151KGT | 1V, 1kHz            | 150         | pF   | ±10%                | 0.50        | ±0.05         | ±0.05  | 3.0%      |                  | (I)        |
|                | C1005X7R181KGT  | C1005X7R181KGT | 1V, 1kHz            | 180         | pF   | ±10%                | 0.50        | ±0.05         | ±0.05  | 3.0%      |                  | (I)        |
|                | C1005X7R221KGT  | C1005X7R221KGT | 1V, 1kHz            | 220         | pF   | ±10%                | 0.50        | ±0.05         | ±0.05  | 3.0%      |                  | (I)        |
|                | C1005X7R271KGT  | C1005X7R271KGT | 1V, 1kHz            | 270         | pF   | ±10%                | 0.50        | ±0.05         | ±0.05  | 3.0%      |                  | (I)        |
|                | C1005X7R331KGT  | C1005X7R331KGT | 1V, 1kHz            | 330         | pF   | ±10%                | 0.50        | ±0.05         | ±0.05  | 3.0%      |                  | (I)        |
|                | C1005X7R391KGT  | C1005X7R391KGT | 1V, 1kHz            | 390         | pF   | ±10%                | 0.50        | ±0.05         | ±0.05  | 3.0%      |                  | (I)        |
|                | C1005X7R471KGT  | C1005X7R471KGT | 1V, 1kHz            | 470         | pF   | ±10%                | 0.50        | ±0.05         | ±0.05  | 3.0%      |                  | (I)        |
|                | C1005X7R561KGT  | C1005X7R561KGT | 1V, 1kHz            | 560         | pF   | ±10%                | 0.50        | ±0.05         | ±0.05  | 3.0%      |                  | (I)        |
|                | C1005X7R681KGT  | C1005X7R681KGT | 1V, 1kHz            | 680         | pF   | ±10%                | 0.50        | ±0.05         | ±0.05  | 3.0%      |                  | (I)        |
|                | C1005X7R751KGT  | C1005X7R751KGT | 1V, 1kHz            | 750         | pF   | ±10%                | 0.50        | ±0.05         | ±0.05  | 3.0%      |                  | (I)        |
|                | C1005X7R821KGT  | C1005X7R821KGT | 1V, 1kHz            | 820         | pF   | ±10%                | 0.50        | ±0.05         | ±0.05  | 3.0%      |                  | (I)        |
|                | C1005X7R102□GTS | C1005X7R102□GT | 1V, 1kHz            | 1.0         | nF   | ±10%, ±5%           | 0.50        | ±0.05         | ±0.05  | 3.0%      |                  | (I)        |
|                | C1005X7R122KGT  | C1005X7R122KGT | 1V, 1kHz            | 1.2         | nF   | ±10%                | 0.50        | ±0.05         | ±0.05  | 3.0%      |                  | (I)        |
|                | C1005X7R152KGT  | C1005X7R152KGT | 1V, 1kHz            | 1.5         | nF   | ±10%                | 0.50        | ±0.05         | ±0.05  | 3.0%      |                  | (I)        |
|                | C1005X7R182KGT  | C1005X7R182KGT | 1V, 1kHz            | 1.8         | nF   | ±10%                | 0.50        | ±0.05         | ±0.05  | 3.0%      |                  | (I)        |
|                | C1005X7R222□GTS | C1005X7R222□GT | 1V, 1kHz            | 2.2         | nF   | ±10%, ±5%           | 0.50        | ±0.05         | ±0.05  | 3.0%      |                  | (I)        |
|                | C1005X7R272□GTS | C1005X7R272□GT | 1V, 1kHz            | 2.7         | nF   | ±10%, ±5%           | 0.50        | ±0.05         | ±0.05  | 3.0%      |                  | (I)        |
|                | C1005X7R332□GTS | C1005X7R332□GT | 1V, 1kHz            | 3.3         | nF   | ±10%, ±5%           | 0.50        | ±0.05         | ±0.05  | 3.0%      |                  | (I)        |
|                | C1005X7R392KGT  | C1005X7R392KGT | 1V, 1kHz            | 3.9         | nF   | ±10%                | 0.50        | ±0.05         | ±0.05  | 3.0%      |                  | (I)        |
|                | C1005X7R472KGT  | C1005X7R472KGT | 1V, 1kHz            | 4.7         | nF   | ±10%                | 0.50        | ±0.05         | ±0.05  | 3.0%      |                  | (I)        |
|                | C1005X7R562KGT  | C1005X7R562KGT | 1V, 1kHz            | 5.6         | nF   | ±10%                | 0.50        | ±0.05         | ±0.05  | 3.0%      |                  | (I)        |
|                | C1005X7R682KGT  | C1005X7R682KGT | 1V, 1kHz            | 6.8         | nF   | ±10%                | 0.50        | ±0.05         | ±0.05  | 3.0%      |                  | (I)        |
|                | C1005X7R822KGT  | C1005X7R822KGT | 1V, 1kHz            | 8.2         | nF   | ±10%                | 0.50        | ±0.05         | ±0.05  | 3.0%      |                  | (I)        |
|                | C1005X7R103KGT  | C1005X7R103KGT | 1V, 1kHz            | 10          | nF   | ±10%                | 0.50        | ±0.05         | ±0.05  | 3.0%      |                  | (I)        |
|                | C1005X7R123KGT  | C1005X7R123KGT | 1V, 1kHz            | 12          | nF   | ±10%                | 0.50        | ±0.05         | ±0.05  | 3.0%      |                  | (I)        |
|                | C1005X7R153KGT  | C1005X7R153KGT | 1V, 1kHz            | 15          | nF   | ±10%                | 0.50        | ±0.05         | ±0.05  | 3.0%      |                  | (I)        |
|                | C1005X7R223KGT  | C1005X7R223KGT | 1V, 1kHz            | 22          | nF   | ±10%                | 0.50        | ±0.05         | ±0.05  | 3.0%      |                  | (I)        |
|                | C1005X7R333KGT  | C1005X7R333KGT | 1V, 1kHz            | 33          | nF   | ±10%                | 0.50        | ±0.05         | ±0.05  | 3.5%      |                  | (I)        |
| C1005X7R473KGT | C1005X7R473KGT  | 1V, 1kHz       | 47                  | nF          | ±10% | 0.50                | ±0.05       | ±0.05         | 10.0%  | (II)      |                  |            |
| C1005X7R104KGT | C1005X7R104KGT  | 1V, 1kHz       | 100                 | nF          | ±10% | 0.50                | ±0.10       | ±0.10         | 10.0%  | (II)      |                  |            |
| 25V            | C1005X7R101KF   | C1005X7R101KFT | 1V, 1kHz            | 100         | pF   | ±10%                | 0.50        | ±0.05         | ±0.05  | 3.0%      | Paper, 10Kpcs    | (I)        |
|                | C1005X7R121KF   | C1005X7R121KFT | 1V, 1kHz            | 120         | pF   | ±10%                | 0.50        | ±0.05         | ±0.05  | 3.0%      |                  | (I)        |
|                | C1005X7R151KF   | C1005X7R151KFT | 1V, 1kHz            | 150         | pF   | ±10%                | 0.50        | ±0.05         | ±0.05  | 3.0%      |                  | (I)        |
|                | C1005X7R181KF   | C1005X7R181KFT | 1V, 1kHz            | 180         | pF   | ±10%                | 0.50        | ±0.05         | ±0.05  | 3.0%      |                  | (I)        |
|                | C1005X7R221KF   | C1005X7R221KFT | 1V, 1kHz            | 220         | pF   | ±10%                | 0.50        | ±0.05         | ±0.05  | 3.0%      |                  | (I)        |
|                | C1005X7R271KF   | C1005X7R271KFT | 1V, 1kHz            | 270         | pF   | ±10%                | 0.50        | ±0.05         | ±0.05  | 3.0%      |                  | (I)        |
|                | C1005X7R331KF   | C1005X7R331KFT | 1V, 1kHz            | 330         | pF   | ±10%                | 0.50        | ±0.05         | ±0.05  | 3.0%      |                  | (I)        |
|                | C1005X7R391KF   | C1005X7R391KFT | 1V, 1kHz            | 390         | pF   | ±10%                | 0.50        | ±0.05         | ±0.05  | 3.0%      |                  | (I)        |
|                | C1005X7R471KF   | C1005X7R471KFT | 1V, 1kHz            | 470         | pF   | ±10%                | 0.50        | ±0.05         | ±0.05  | 3.0%      |                  | (I)        |
|                | C1005X7R561KF   | C1005X7R561KFT | 1V, 1kHz            | 560         | pF   | ±10%                | 0.50        | ±0.05         | ±0.05  | 3.0%      |                  | (I)        |
|                | C1005X7R681KF   | C1005X7R681KFT | 1V, 1kHz            | 680         | pF   | ±10%                | 0.50        | ±0.05         | ±0.05  | 3.0%      |                  | (I)        |
|                | C1005X7R821KF   | C1005X7R821KFT | 1V, 1kHz            | 820         | pF   | ±10%                | 0.50        | ±0.05         | ±0.05  | 3.0%      |                  | (I)        |
|                | C1005X7R102KF   | C1005X7R102KFT | 1V, 1kHz            | 1.0         | nF   | ±10%                | 0.50        | ±0.05         | ±0.05  | 3.0%      |                  | (I)        |
|                | C1005X7R122KF   | C1005X7R122KFT | 1V, 1kHz            | 1.2         | nF   | ±10%                | 0.50        | ±0.05         | ±0.05  | 3.0%      |                  | (I)        |
|                | C1005X7R152KF   | C1005X7R152KFT | 1V, 1kHz            | 1.5         | nF   | ±10%                | 0.50        | ±0.05         | ±0.05  | 3.0%      |                  | (I)        |
|                | C1005X7R182KF   | C1005X7R182KFT | 1V, 1kHz            | 1.8         | nF   | ±10%                | 0.50        | ±0.05         | ±0.05  | 3.0%      |                  | (I)        |
|                | C1005X7R222KF   | C1005X7R222KFT | 1V, 1kHz            | 2.2         | nF   | ±10%                | 0.50        | ±0.05         | ±0.05  | 3.0%      |                  | (I)        |
|                | C1005X7R272KF   | C1005X7R272KFT | 1V, 1kHz            | 2.7         | nF   | ±10%                | 0.50        | ±0.05         | ±0.05  | 3.0%      |                  | (I)        |
|                | C1005X7R332□F   | C1005X7R332□FT | 1V, 1kHz            | 3.3         | nF   | ±10%, ±5%           | 0.50        | ±0.05         | ±0.05  | 3.0%      |                  | (I)        |
|                | C1005X7R392KF   | C1005X7R392KFT | 1V, 1kHz            | 3.9         | nF   | ±10%                | 0.50        | ±0.05         | ±0.05  | 3.0%      |                  | (I)        |
|                | C1005X7R472KF   | C1005X7R472KFT | 1V, 1kHz            | 4.7         | nF   | ±10%                | 0.50        | ±0.05         | ±0.05  | 3.0%      |                  | (I)        |
|                | C1005X7R562KF   | C1005X7R562KFT | 1V, 1kHz            | 5.6         | nF   | ±10%                | 0.50        | ±0.05         | ±0.05  | 3.0%      |                  | (I)        |
|                | C1005X7R682KF   | C1005X7R682KFT | 1V, 1kHz            | 6.8         | nF   | ±10%                | 0.50        | ±0.05         | ±0.05  | 3.0%      |                  | (I)        |
|                | C1005X7R822KF   | C1005X7R822KFT | 1V, 1kHz            | 8.2         | nF   | ±10%                | 0.50        | ±0.05         | ±0.05  | 3.0%      |                  | (I)        |
|                | C1005X7R103□F   | C1005X7R103□FT | 1V, 1kHz            | 10          | nF   | ±10%, ±5%           | 0.50        | ±0.05         | ±0.05  | 3.0%      |                  | (I)        |
|                | C1005X7R123KF   | C1005X7R123KFT | 1V, 1kHz            | 12          | nF   | ±10%                | 0.50        | ±0.05         | ±0.05  | 3.0%      |                  | (I)        |
|                | C1005X7R153□F   | C1005X7R153□FT | 1V, 1kHz            | 15          | nF   | ±10%, ±5%           | 0.50        | ±0.05         | ±0.05  | 3.0%      |                  | (I)        |
|                | C1005X7R183KF   | C1005X7R183KFT | 1V, 1kHz            | 18          | nF   | ±10%                | 0.50        | ±0.05         | ±0.05  | 3.0%      |                  | (I)        |
|                | C1005X7R223□F   | C1005X7R223□FT | 1V, 1kHz            | 22          | nF   | ±10%, ±5%           | 0.50        | ±0.05         | ±0.05  | 3.0%      |                  | (I)        |
|                | C1005X7R273KF   | C1005X7R273KFT | 1V, 1kHz            | 27          | nF   | ±10%                | 0.50        | ±0.05         | ±0.05  | 3.5%      |                  | (I)        |
| C1005X7R333KF  | C1005X7R333KFT  | 1V, 1kHz       | 33                  | nF          | ±10% | 0.50                | ±0.05       | ±0.05         | 3.5%   | (I)       |                  |            |
| C1005X7R473KF  | C1005X7R473KFT  | 1V, 1kHz       | 47                  | nF          | ±10% | 0.50                | ±0.05       | ±0.05         | 3.5%   | (I)       |                  |            |
| C1005X7R563KF  | C1005X7R563KFT  | 1V, 1kHz       | 56                  | nF          | ±10% | 0.50                | ±0.05       | ±0.05         | 3.5%   | (I)       |                  |            |
| C1005X7R683KF  | C1005X7R683KFT  | 1V, 1kHz       | 68                  | nF          | ±10% | 0.50                | ±0.05       | ±0.05         | 3.5%   | (I)       |                  |            |
| C1005X7R104KF  | C1005X7R104KFT  | 1V, 1kHz       | 100                 | nF          | ±10% | 0.50                | ±0.05       | ±0.05         | 10.0%  | (II)      |                  |            |
| C1005X7R224KF  | C1005X7R224KFT  | 1V, 1kHz       | 220                 | nF          | ±10% | 0.50                | ±0.05       | ±0.05         | 10.0%  | (II)      |                  |            |
| 16V            | C1005X7R101KETS | C1005X7R101KET | 1V, 1kHz            | 100         | pF   | ±10%                | 0.50        | ±0.05         | ±0.05  | 5.0%      | Paper, 10Kpcs    | (I)        |
|                | C1005X7R121KETS | C1005X7R121KET | 1V, 1kHz            | 120         | pF   | ±10%                | 0.50        | ±0.05         | ±0.05  | 5.0%      |                  | (I)        |
|                | C1005X7R151KETS | C1005X7R151KET | 1V, 1kHz            | 150         | pF   | ±10%                | 0.50        | ±0.05         | ±0.05  | 5.0%      |                  | (I)        |
|                | C1005X7R181KETS | C1005X7R181KET | 1V, 1kHz            | 180         | pF   | ±10%                | 0.50        | ±0.05         | ±0.05  | 5.0%      |                  | (I)        |
|                | C1005X7R221KETS | C1005X7R221KET | 1V, 1kHz            | 220         | pF   | ±10%                | 0.50        | ±0.05         | ±0.05  | 5.0%      |                  | (I)        |

| RV              | DARFON P/N      | DARFON P/N 2   | Measuring Condition | Capacitance |           | Available Tolerance | Thick. (mm) | Tolerance(mm) |        | DF (max.) | Standard Packing | Test Spec. |
|-----------------|-----------------|----------------|---------------------|-------------|-----------|---------------------|-------------|---------------|--------|-----------|------------------|------------|
|                 |                 |                |                     | Value       | Unit      |                     |             | L/W           | Thick. |           |                  |            |
| 16V             | C1005X7R271KETS | C1005X7R271KET | 1V, 1kHz            | 270         | pF        | ±10%                | 0.50        | ±0.05         | ±0.05  | 5.0%      | Paper, 10Kpcs    | (I)        |
|                 | C1005X7R331KETS | C1005X7R331KET | 1V, 1kHz            | 330         | pF        | ±10%                | 0.50        | ±0.05         | ±0.05  | 5.0%      |                  | (I)        |
|                 | C1005X7R391KETS | C1005X7R391KET | 1V, 1kHz            | 390         | pF        | ±10%                | 0.50        | ±0.05         | ±0.05  | 5.0%      |                  | (I)        |
|                 | C1005X7R471KETS | C1005X7R471KET | 1V, 1kHz            | 470         | pF        | ±10%                | 0.50        | ±0.05         | ±0.05  | 5.0%      |                  | (I)        |
|                 | C1005X7R561KETS | C1005X7R561KET | 1V, 1kHz            | 560         | pF        | ±10%                | 0.50        | ±0.05         | ±0.05  | 5.0%      |                  | (I)        |
|                 | C1005X7R681KETS | C1005X7R681KET | 1V, 1kHz            | 680         | pF        | ±10%                | 0.50        | ±0.05         | ±0.05  | 5.0%      |                  | (I)        |
|                 | C1005X7R821KETS | C1005X7R821KET | 1V, 1kHz            | 820         | pF        | ±10%                | 0.50        | ±0.05         | ±0.05  | 5.0%      |                  | (I)        |
|                 | C1005X7R102KETS | C1005X7R102KET | 1V, 1kHz            | 1.0         | nF        | ±10%                | 0.50        | ±0.05         | ±0.05  | 5.0%      |                  | (I)        |
|                 | C1005X7R122KETS | C1005X7R122KET | 1V, 1kHz            | 1.2         | nF        | ±10%                | 0.50        | ±0.05         | ±0.05  | 5.0%      |                  | (I)        |
|                 | C1005X7R152KETS | C1005X7R152KET | 1V, 1kHz            | 1.5         | nF        | ±10%                | 0.50        | ±0.05         | ±0.05  | 5.0%      |                  | (I)        |
|                 | C1005X7R182KETS | C1005X7R182KET | 1V, 1kHz            | 1.8         | nF        | ±10%                | 0.50        | ±0.05         | ±0.05  | 5.0%      |                  | (I)        |
|                 | C1005X7R222KETS | C1005X7R222KET | 1V, 1kHz            | 2.2         | nF        | ±10%                | 0.50        | ±0.05         | ±0.05  | 5.0%      |                  | (I)        |
|                 | C1005X7R272KETS | C1005X7R272KET | 1V, 1kHz            | 2.7         | nF        | ±10%                | 0.50        | ±0.05         | ±0.05  | 5.0%      |                  | (I)        |
|                 | C1005X7R332KETS | C1005X7R332KET | 1V, 1kHz            | 3.3         | nF        | ±10%                | 0.50        | ±0.05         | ±0.05  | 5.0%      |                  | (I)        |
|                 | C1005X7R392KETS | C1005X7R392KET | 1V, 1kHz            | 3.9         | nF        | ±10%                | 0.50        | ±0.05         | ±0.05  | 5.0%      |                  | (I)        |
|                 | C1005X7R472KETS | C1005X7R472KET | 1V, 1kHz            | 4.7         | nF        | ±10%                | 0.50        | ±0.05         | ±0.05  | 5.0%      |                  | (I)        |
|                 | C1005X7R562KETS | C1005X7R562KET | 1V, 1kHz            | 5.6         | nF        | ±10%                | 0.50        | ±0.05         | ±0.05  | 5.0%      |                  | (I)        |
|                 | C1005X7R682KETS | C1005X7R682KET | 1V, 1kHz            | 6.8         | nF        | ±10%                | 0.50        | ±0.05         | ±0.05  | 5.0%      |                  | (I)        |
|                 | C1005X7R822KETS | C1005X7R822KET | 1V, 1kHz            | 8.2         | nF        | ±10%                | 0.50        | ±0.05         | ±0.05  | 5.0%      |                  | (I)        |
|                 | C1005X7R103KETS | C1005X7R103KET | 1V, 1kHz            | 10          | nF        | ±10%                | 0.50        | ±0.05         | ±0.05  | 5.0%      |                  | (I)        |
|                 | C1005X7R123KETS | C1005X7R123KET | 1V, 1kHz            | 12          | nF        | ±10%                | 0.50        | ±0.05         | ±0.05  | 5.0%      |                  | (I)        |
|                 | C1005X7R153KETS | C1005X7R153KET | 1V, 1kHz            | 15          | nF        | ±10%                | 0.50        | ±0.05         | ±0.05  | 5.0%      |                  | (I)        |
|                 | C1005X7R183KETS | C1005X7R183KET | 1V, 1kHz            | 18          | nF        | ±10%                | 0.50        | ±0.05         | ±0.05  | 5.0%      |                  | (I)        |
|                 | C1005X7R223KETS | C1005X7R223KET | 1V, 1kHz            | 22          | nF        | ±10%                | 0.50        | ±0.05         | ±0.05  | 5.0%      |                  | (I)        |
|                 | C1005X7R273KETS | C1005X7R273KET | 1V, 1kHz            | 27          | nF        | ±10%                | 0.50        | ±0.05         | ±0.05  | 5.0%      |                  | (I)        |
|                 | C1005X7R333KETS | C1005X7R333KET | 1V, 1kHz            | 33          | nF        | ±10%                | 0.50        | ±0.05         | ±0.05  | 5.0%      |                  | (I)        |
|                 | C1005X7R393KETS | C1005X7R393KET | 1V, 1kHz            | 39          | nF        | ±10%                | 0.50        | ±0.05         | ±0.05  | 5.0%      |                  | (I)        |
|                 | C1005X7R473KETS | C1005X7R473KET | 1V, 1kHz            | 47          | nF        | ±10%                | 0.50        | ±0.05         | ±0.05  | 5.0%      |                  | (I)        |
|                 | C1005X7R563KETS | C1005X7R563KET | 1V, 1kHz            | 56          | nF        | ±10%                | 0.50        | ±0.05         | ±0.05  | 5.0%      |                  | (I)        |
|                 | C1005X7R683KETS | C1005X7R683KET | 1V, 1kHz            | 68          | nF        | ±10%                | 0.50        | ±0.05         | ±0.05  | 5.0%      |                  | (I)        |
|                 | C1005X7R823KETS | C1005X7R823KET | 1V, 1kHz            | 82          | nF        | ±10%                | 0.50        | ±0.05         | ±0.05  | 5.0%      |                  | (I)        |
|                 | C1005X7R104□ETS | C1005X7R104□ET | 1V, 1kHz            | 100         | nF        | ±10%, ±20%          | 0.50        | ±0.05         | ±0.05  | 5.0%      |                  | (I)        |
|                 | C1005X7R154KETS | C1005X7R154KET | 1V, 1kHz            | 150         | nF        | ±10%                | 0.50        | ±0.05         | ±0.05  | 10.0%     |                  | (II)       |
| C1005X7R224KETS | C1005X7R224KET  | 1V, 1kHz       | 220                 | nF          | ±10%      | 0.50                | ±0.05       | ±0.05         | 10.0%  | (II)      |                  |            |
| 10V             | C1005X7R101KDTS | C1005X7R101KDT | 1V, 1kHz            | 100         | pF        | ±10%                | 0.50        | ±0.05         | ±0.05  | 5.0%      | Paper, 10Kpcs    | (I)        |
|                 | C1005X7R121KDTS | C1005X7R121KDT | 1V, 1kHz            | 120         | pF        | ±10%                | 0.50        | ±0.05         | ±0.05  | 5.0%      |                  | (I)        |
|                 | C1005X7R151KDTS | C1005X7R151KDT | 1V, 1kHz            | 150         | pF        | ±10%                | 0.50        | ±0.05         | ±0.05  | 5.0%      |                  | (I)        |
|                 | C1005X7R181KDTS | C1005X7R181KDT | 1V, 1kHz            | 180         | pF        | ±10%                | 0.50        | ±0.05         | ±0.05  | 5.0%      |                  | (I)        |
|                 | C1005X7R221KDTS | C1005X7R221KDT | 1V, 1kHz            | 220         | pF        | ±10%                | 0.50        | ±0.05         | ±0.05  | 5.0%      |                  | (I)        |
|                 | C1005X7R271KDTS | C1005X7R271KDT | 1V, 1kHz            | 270         | pF        | ±10%                | 0.50        | ±0.05         | ±0.05  | 5.0%      |                  | (I)        |
|                 | C1005X7R331KDTS | C1005X7R331KDT | 1V, 1kHz            | 330         | pF        | ±10%                | 0.50        | ±0.05         | ±0.05  | 5.0%      |                  | (I)        |
|                 | C1005X7R391KDTS | C1005X7R391KDT | 1V, 1kHz            | 390         | pF        | ±10%                | 0.50        | ±0.05         | ±0.05  | 5.0%      |                  | (I)        |
|                 | C1005X7R471KDTS | C1005X7R471KDT | 1V, 1kHz            | 470         | pF        | ±10%                | 0.50        | ±0.05         | ±0.05  | 5.0%      |                  | (I)        |
|                 | C1005X7R561KDTS | C1005X7R561KDT | 1V, 1kHz            | 560         | pF        | ±10%                | 0.50        | ±0.05         | ±0.05  | 5.0%      |                  | (I)        |
|                 | C1005X7R681KDTS | C1005X7R681KDT | 1V, 1kHz            | 680         | pF        | ±10%                | 0.50        | ±0.05         | ±0.05  | 5.0%      |                  | (I)        |
|                 | C1005X7R821KDTS | C1005X7R821KDT | 1V, 1kHz            | 820         | pF        | ±10%                | 0.50        | ±0.05         | ±0.05  | 5.0%      |                  | (I)        |
|                 | C1005X7R102KDTS | C1005X7R102KDT | 1V, 1kHz            | 1.0         | nF        | ±10%                | 0.50        | ±0.05         | ±0.05  | 5.0%      |                  | (I)        |
|                 | C1005X7R122KDTS | C1005X7R122KDT | 1V, 1kHz            | 1.2         | nF        | ±10%                | 0.50        | ±0.05         | ±0.05  | 5.0%      |                  | (I)        |
|                 | C1005X7R152KDTS | C1005X7R152KDT | 1V, 1kHz            | 1.5         | nF        | ±10%                | 0.50        | ±0.05         | ±0.05  | 5.0%      |                  | (I)        |
|                 | C1005X7R182KDTS | C1005X7R182KDT | 1V, 1kHz            | 1.8         | nF        | ±10%                | 0.50        | ±0.05         | ±0.05  | 5.0%      |                  | (I)        |
|                 | C1005X7R222KDTS | C1005X7R222KDT | 1V, 1kHz            | 2.2         | nF        | ±10%                | 0.50        | ±0.05         | ±0.05  | 5.0%      |                  | (I)        |
|                 | C1005X7R272KDTS | C1005X7R272KDT | 1V, 1kHz            | 2.7         | nF        | ±10%                | 0.50        | ±0.05         | ±0.05  | 5.0%      |                  | (I)        |
|                 | C1005X7R332KDTS | C1005X7R332KDT | 1V, 1kHz            | 3.3         | nF        | ±10%                | 0.50        | ±0.05         | ±0.05  | 5.0%      |                  | (I)        |
|                 | C1005X7R392KDTS | C1005X7R392KDT | 1V, 1kHz            | 3.9         | nF        | ±10%                | 0.50        | ±0.05         | ±0.05  | 5.0%      |                  | (I)        |
|                 | C1005X7R472KDTS | C1005X7R472KDT | 1V, 1kHz            | 4.7         | nF        | ±10%                | 0.50        | ±0.05         | ±0.05  | 5.0%      |                  | (I)        |
|                 | C1005X7R562KDTS | C1005X7R562KDT | 1V, 1kHz            | 5.6         | nF        | ±10%                | 0.50        | ±0.05         | ±0.05  | 5.0%      |                  | (I)        |
|                 | C1005X7R682KDTS | C1005X7R682KDT | 1V, 1kHz            | 6.8         | nF        | ±10%                | 0.50        | ±0.05         | ±0.05  | 5.0%      |                  | (I)        |
|                 | C1005X7R822KDTS | C1005X7R822KDT | 1V, 1kHz            | 8.2         | nF        | ±10%                | 0.50        | ±0.05         | ±0.05  | 5.0%      |                  | (I)        |
|                 | C1005X7R103KDTS | C1005X7R103KDT | 1V, 1kHz            | 10          | nF        | ±10%                | 0.50        | ±0.05         | ±0.05  | 5.0%      |                  | (I)        |
|                 | C1005X7R123KDTS | C1005X7R123KDT | 1V, 1kHz            | 12          | nF        | ±10%                | 0.50        | ±0.05         | ±0.05  | 5.0%      |                  | (I)        |
|                 | C1005X7R153KDTS | C1005X7R153KDT | 1V, 1kHz            | 15          | nF        | ±10%                | 0.50        | ±0.05         | ±0.05  | 5.0%      |                  | (I)        |
|                 | C1005X7R183KDTS | C1005X7R183KDT | 1V, 1kHz            | 18          | nF        | ±10%                | 0.50        | ±0.05         | ±0.05  | 5.0%      |                  | (I)        |
|                 | C1005X7R223KDTS | C1005X7R223KDT | 1V, 1kHz            | 22          | nF        | ±10%                | 0.50        | ±0.05         | ±0.05  | 5.0%      |                  | (I)        |
|                 | C1005X7R273KDTS | C1005X7R273KDT | 1V, 1kHz            | 27          | nF        | ±10%                | 0.50        | ±0.05         | ±0.05  | 5.0%      |                  | (I)        |
|                 | C1005X7R333KDTS | C1005X7R333KDT | 1V, 1kHz            | 33          | nF        | ±10%                | 0.50        | ±0.05         | ±0.05  | 5.0%      |                  | (I)        |
|                 | C1005X7R393KDTS | C1005X7R393KDT | 1V, 1kHz            | 39          | nF        | ±10%                | 0.50        | ±0.05         | ±0.05  | 5.0%      |                  | (I)        |
|                 | C1005X7R473KDTS | C1005X7R473KDT | 1V, 1kHz            | 47          | nF        | ±10%                | 0.50        | ±0.05         | ±0.05  | 5.0%      |                  | (I)        |
| C1005X7R563KDTS | C1005X7R563KDT  | 1V, 1kHz       | 56                  | nF          | ±10%      | 0.50                | ±0.05       | ±0.05         | 5.0%   | (I)       |                  |            |
| C1005X7R683KDTS | C1005X7R683KDT  | 1V, 1kHz       | 68                  | nF          | ±10%      | 0.50                | ±0.05       | ±0.05         | 5.0%   | (I)       |                  |            |
| C1005X7R823KDTS | C1005X7R823KDT  | 1V, 1kHz       | 82                  | nF          | ±10%      | 0.50                | ±0.05       | ±0.05         | 5.0%   | (I)       |                  |            |
| C1005X7R104□DTS | C1005X7R104□DT  | 1V, 1kHz       | 100                 | nF          | ±10%, ±5% | 0.50                | ±0.05       | ±0.05         | 5.0%   | (I)       |                  |            |
| C1005X7R224KDTS | C1005X7R224KDT  | 1V, 1kHz       | 220                 | nF          | ±10%      | 0.50                | ±0.05       | ±0.05         | 10.0%  | (II)      |                  |            |
| C1005X7R474KDTS | C1005X7R474KDT  | 1V, 1kHz       | 470                 | nF          | ±10%      | 0.50                | ±0.05       | ±0.05         | 10.0%  | (II)      |                  |            |
| 6.3V            | C1005X7R103KCTS | C1005X7R103KCT | 1V, 1kHz            | 10          | nF        | ±10%                | 0.50        | ±0.05         | ±0.05  | 5.0%      | Paper, 10Kpcs    | (I)        |
|                 | C1005X7R473KCTS | C1005X7R473KCT | 1V, 1kHz            | 47          | nF        | ±10%                | 0.50        | ±0.05         | ±0.05  | 5.0%      |                  | (I)        |
|                 | C1005X7R104KCTS | C1005X7R104KCT | 1V, 1kHz            | 100         | nF        | ±10%                | 0.50        | ±0.05         | ±0.05  | 5.0%      |                  | (I)        |
|                 | C1005X7R474□CTS | C1005X7R474□CT | 1V, 1kHz            | 470         | nF        | ±10%, ±20%          | 0.50        | ±0.05         | ±0.05  | 10.0%     |                  | (II)       |
|                 | C1005X7R105□CTS | C1005X7R105□CT | 1V, 1kHz            | 1.0         | uF        | ±10%, ±20%          | 0.50        | ±0.05         | ±0.05  | 12.5%     |                  | (III)*     |

□ Tolerance Code: J=±5%, K=±10%, M=±20%.

● C1608X7R Series (EIA0603)

| RV              | DARFON P/N      | DARFON P/N 2   | Measuring Condition | Capacitance |      | Available Tolerance | Thick. (mm) | Tolerance(mm) |        | DF (max.) | Standard Packing | Test Spec. |
|-----------------|-----------------|----------------|---------------------|-------------|------|---------------------|-------------|---------------|--------|-----------|------------------|------------|
|                 |                 |                |                     | Value       | Unit |                     |             | L/W           | Thick. |           |                  |            |
| 50V             | C1608X7R101KGTS | C1608X7R101KGT | 1V, 1kHz            | 100         | pF   | ±10%                | 0.80        | ±0.10         | ±0.10  | 2.5%      | Paper, 4Kpcs     | (I)        |
|                 | C1608X7R121KGTS | C1608X7R121KGT | 1V, 1kHz            | 120         | pF   | ±10%                | 0.80        | ±0.10         | ±0.10  | 2.5%      |                  | (I)        |
|                 | C1608X7R151KGTS | C1608X7R151KGT | 1V, 1kHz            | 150         | pF   | ±10%                | 0.80        | ±0.10         | ±0.10  | 2.5%      |                  | (I)        |
|                 | C1608X7R181KGTS | C1608X7R181KGT | 1V, 1kHz            | 180         | pF   | ±10%                | 0.80        | ±0.10         | ±0.10  | 2.5%      |                  | (I)        |
|                 | C1608X7R221KGTS | C1608X7R221KGT | 1V, 1kHz            | 220         | pF   | ±10%                | 0.80        | ±0.10         | ±0.10  | 2.5%      |                  | (I)        |
|                 | C1608X7R271KGTS | C1608X7R271KGT | 1V, 1kHz            | 270         | pF   | ±10%                | 0.80        | ±0.10         | ±0.10  | 2.5%      |                  | (I)        |
|                 | C1608X7R331KGTS | C1608X7R331KGT | 1V, 1kHz            | 330         | pF   | ±10%                | 0.80        | ±0.10         | ±0.10  | 2.5%      |                  | (I)        |
|                 | C1608X7R391KGTS | C1608X7R391KGT | 1V, 1kHz            | 390         | pF   | ±10%                | 0.80        | ±0.10         | ±0.10  | 2.5%      |                  | (I)        |
|                 | C1608X7R471KGTS | C1608X7R471KGT | 1V, 1kHz            | 470         | pF   | ±10%                | 0.80        | ±0.10         | ±0.10  | 2.5%      |                  | (I)        |
|                 | C1608X7R561KGTS | C1608X7R561KGT | 1V, 1kHz            | 560         | pF   | ±10%                | 0.80        | ±0.10         | ±0.10  | 2.5%      |                  | (I)        |
|                 | C1608X7R681KGTS | C1608X7R681KGT | 1V, 1kHz            | 680         | pF   | ±10%                | 0.80        | ±0.10         | ±0.10  | 2.5%      |                  | (I)        |
|                 | C1608X7R821KGTS | C1608X7R821KGT | 1V, 1kHz            | 820         | pF   | ±10%                | 0.80        | ±0.10         | ±0.10  | 2.5%      |                  | (I)        |
|                 | C1608X7R102KGT  | C1608X7R102KGT | 1V, 1kHz            | 1.0         | nF   | ±10%                | 0.80        | ±0.10         | ±0.10  | 2.5%      |                  | (I)        |
|                 | C1608X7R122KGT  | C1608X7R122KGT | 1V, 1kHz            | 1.2         | nF   | ±10%                | 0.80        | ±0.10         | ±0.10  | 2.5%      |                  | (I)        |
|                 | C1608X7R152KGT  | C1608X7R152KGT | 1V, 1kHz            | 1.5         | nF   | ±10%                | 0.80        | ±0.10         | ±0.10  | 2.5%      |                  | (I)        |
|                 | C1608X7R182KGT  | C1608X7R182KGT | 1V, 1kHz            | 1.8         | nF   | ±10%                | 0.80        | ±0.10         | ±0.10  | 2.5%      |                  | (I)        |
|                 | C1608X7R202KGT  | C1608X7R202KGT | 1V, 1kHz            | 2.0         | nF   | ±10%                | 0.80        | ±0.10         | ±0.10  | 2.5%      |                  | (I)        |
|                 | C1608X7R222KGT  | C1608X7R222KGT | 1V, 1kHz            | 2.2         | nF   | ±10%                | 0.80        | ±0.10         | ±0.10  | 2.5%      |                  | (I)        |
|                 | C1608X7R272KGT  | C1608X7R272KGT | 1V, 1kHz            | 2.7         | nF   | ±10%                | 0.80        | ±0.10         | ±0.10  | 2.5%      |                  | (I)        |
|                 | C1608X7R332KGT  | C1608X7R332KGT | 1V, 1kHz            | 3.3         | nF   | ±10%                | 0.80        | ±0.10         | ±0.10  | 2.5%      |                  | (I)        |
|                 | C1608X7R392KGT  | C1608X7R392KGT | 1V, 1kHz            | 3.9         | nF   | ±10%                | 0.80        | ±0.10         | ±0.10  | 2.5%      |                  | (I)        |
|                 | C1608X7R472KGT  | C1608X7R472KGT | 1V, 1kHz            | 4.7         | nF   | ±10%                | 0.80        | ±0.10         | ±0.10  | 2.5%      |                  | (I)        |
|                 | C1608X7R562KGT  | C1608X7R562KGT | 1V, 1kHz            | 5.6         | nF   | ±10%                | 0.80        | ±0.10         | ±0.10  | 2.5%      |                  | (I)        |
|                 | C1608X7R682KGT  | C1608X7R682KGT | 1V, 1kHz            | 6.8         | nF   | ±10%                | 0.80        | ±0.10         | ±0.10  | 2.5%      |                  | (I)        |
|                 | C1608X7R822KGT  | C1608X7R822KGT | 1V, 1kHz            | 8.2         | nF   | ±10%                | 0.80        | ±0.10         | ±0.10  | 2.5%      |                  | (I)        |
|                 | C1608X7R103□GTS | C1608X7R103□GT | 1V, 1kHz            | 10          | nF   | ±10%,±5%            | 0.80        | ±0.10         | ±0.10  | 2.5%      |                  | (I)        |
|                 | C1608X7R123KGT  | C1608X7R123KGT | 1V, 1kHz            | 12          | nF   | ±10%                | 0.80        | ±0.10         | ±0.10  | 2.5%      |                  | (I)        |
|                 | C1608X7R153KGT  | C1608X7R153KGT | 1V, 1kHz            | 15          | nF   | ±10%                | 0.80        | ±0.10         | ±0.10  | 2.5%      |                  | (I)        |
|                 | C1608X7R183□GTS | C1608X7R183□GT | 1V, 1kHz            | 18          | nF   | ±10%,±5%            | 0.80        | ±0.10         | ±0.10  | 2.5%      |                  | (I)        |
|                 | C1608X7R223KGT  | C1608X7R223KGT | 1V, 1kHz            | 22          | nF   | ±10%                | 0.80        | ±0.10         | ±0.10  | 2.5%      |                  | (I)        |
|                 | C1608X7R273KGT  | C1608X7R273KGT | 1V, 1kHz            | 27          | nF   | ±10%                | 0.80        | ±0.10         | ±0.10  | 2.5%      |                  | (I)        |
|                 | C1608X7R333KGT  | C1608X7R333KGT | 1V, 1kHz            | 33          | nF   | ±10%                | 0.80        | ±0.15         | ±0.15  | 2.5%      |                  | (I)        |
|                 | C1608X7R393KGT  | C1608X7R393KGT | 1V, 1kHz            | 39          | nF   | ±10%                | 0.80        | ±0.15         | ±0.15  | 2.5%      |                  | (I)        |
| C1608X7R473KGT  | C1608X7R473KGT  | 1V, 1kHz       | 47                  | nF          | ±10% | 0.80                | ±0.15       | ±0.15         | 3.0%   | (I)       |                  |            |
| C1608X7R563KGT  | C1608X7R563KGT  | 1V, 1kHz       | 56                  | nF          | ±10% | 0.80                | ±0.15       | ±0.15         | 3.0%   | (I)       |                  |            |
| C1608X7R683KGT  | C1608X7R683KGT  | 1V, 1kHz       | 68                  | nF          | ±10% | 0.80                | ±0.15       | ±0.15         | 3.0%   | (I)       |                  |            |
| C1608X7R823KGT  | C1608X7R823KGT  | 1V, 1kHz       | 82                  | nF          | ±10% | 0.80                | ±0.15       | ±0.15         | 3.0%   | (I)       |                  |            |
| C1608X7R104KGT  | C1608X7R104KGT  | 1V, 1kHz       | 100                 | nF          | ±10% | 0.80                | ±0.15       | ±0.15         | 3.0%   | (II)      |                  |            |
| C1608X7R224KGT  | C1608X7R224KGT  | 1V, 1kHz       | 220                 | nF          | ±10% | 0.80                | ±0.15       | ±0.15         | 3.5%   | (II)      |                  |            |
| C1608X7R474KGT  | C1608X7R474KGT  | 1V, 1kHz       | 470                 | nF          | ±10% | 0.80                | ±0.15       | ±0.15         | 10.0%  | (II)      |                  |            |
| C1608X7R105KGT  | C1608X7R105KGT  | 1V, 1kHz       | 1.0                 | uF          | ±10% | 0.80                | ±0.20       | ±0.20         | 10.0%  | (II)      |                  |            |
| C1608X7R474KNTS | C1608X7R474KNT  | 1V, 1kHz       | 470                 | nF          | ±10% | 0.80                | ±0.15       | ±0.15         | 10.0%  | (II)      |                  |            |
| C1608X7R105KNTS | C1608X7R105KNT  | 1V, 1kHz       | 1.0                 | uF          | ±10% | 0.80                | ±0.20       | ±0.20         | 10.0%  | (II)      |                  |            |
| 25V             | C1608X7R101KFST | C1608X7R101KFT | 1V, 1kHz            | 100         | pF   | ±10%                | 0.80        | ±0.10         | ±0.10  | 3.5%      | Paper, 4Kpcs     | (I)        |
|                 | C1608X7R121KFST | C1608X7R121KFT | 1V, 1kHz            | 120         | pF   | ±10%                | 0.80        | ±0.10         | ±0.10  | 3.5%      |                  | (I)        |
|                 | C1608X7R151KFST | C1608X7R151KFT | 1V, 1kHz            | 150         | pF   | ±10%                | 0.80        | ±0.10         | ±0.10  | 3.5%      |                  | (I)        |
|                 | C1608X7R181KFST | C1608X7R181KFT | 1V, 1kHz            | 180         | pF   | ±10%                | 0.80        | ±0.10         | ±0.10  | 3.5%      |                  | (I)        |
|                 | C1608X7R221KFST | C1608X7R221KFT | 1V, 1kHz            | 220         | pF   | ±10%                | 0.80        | ±0.10         | ±0.10  | 3.5%      |                  | (I)        |
|                 | C1608X7R271KFST | C1608X7R271KFT | 1V, 1kHz            | 270         | pF   | ±10%                | 0.80        | ±0.10         | ±0.10  | 3.5%      |                  | (I)        |
|                 | C1608X7R331KFST | C1608X7R331KFT | 1V, 1kHz            | 330         | pF   | ±10%                | 0.80        | ±0.10         | ±0.10  | 3.5%      |                  | (I)        |
|                 | C1608X7R391KFST | C1608X7R391KFT | 1V, 1kHz            | 390         | pF   | ±10%                | 0.80        | ±0.10         | ±0.10  | 3.5%      |                  | (I)        |
|                 | C1608X7R471KFST | C1608X7R471KFT | 1V, 1kHz            | 470         | pF   | ±10%                | 0.80        | ±0.10         | ±0.10  | 3.5%      |                  | (I)        |
|                 | C1608X7R561KFST | C1608X7R561KFT | 1V, 1kHz            | 560         | pF   | ±10%                | 0.80        | ±0.10         | ±0.10  | 3.5%      |                  | (I)        |
|                 | C1608X7R681KFST | C1608X7R681KFT | 1V, 1kHz            | 680         | pF   | ±10%                | 0.80        | ±0.10         | ±0.10  | 3.5%      |                  | (I)        |
|                 | C1608X7R821KFST | C1608X7R821KFT | 1V, 1kHz            | 820         | pF   | ±10%                | 0.80        | ±0.10         | ±0.10  | 3.5%      |                  | (I)        |
|                 | C1608X7R102KFST | C1608X7R102KFT | 1V, 1kHz            | 1.0         | nF   | ±10%                | 0.80        | ±0.10         | ±0.10  | 3.5%      |                  | (I)        |
|                 | C1608X7R122KFST | C1608X7R122KFT | 1V, 1kHz            | 1.2         | nF   | ±10%                | 0.80        | ±0.10         | ±0.10  | 3.5%      |                  | (I)        |
|                 | C1608X7R152KFST | C1608X7R152KFT | 1V, 1kHz            | 1.5         | nF   | ±10%                | 0.80        | ±0.10         | ±0.10  | 3.5%      |                  | (I)        |
|                 | C1608X7R182KFST | C1608X7R182KFT | 1V, 1kHz            | 1.8         | nF   | ±10%                | 0.80        | ±0.10         | ±0.10  | 3.5%      |                  | (I)        |
|                 | C1608X7R222KFST | C1608X7R222KFT | 1V, 1kHz            | 2.2         | nF   | ±10%                | 0.80        | ±0.10         | ±0.10  | 3.5%      |                  | (I)        |
|                 | C1608X7R272KFST | C1608X7R272KFT | 1V, 1kHz            | 2.7         | nF   | ±10%                | 0.80        | ±0.10         | ±0.10  | 3.5%      |                  | (I)        |
|                 | C1608X7R332KFST | C1608X7R332KFT | 1V, 1kHz            | 3.3         | nF   | ±10%                | 0.80        | ±0.10         | ±0.10  | 3.5%      |                  | (I)        |
|                 | C1608X7R392KFST | C1608X7R392KFT | 1V, 1kHz            | 3.9         | nF   | ±10%                | 0.80        | ±0.10         | ±0.10  | 3.5%      |                  | (I)        |
| C1608X7R472KFST | C1608X7R472KFT  | 1V, 1kHz       | 4.7                 | nF          | ±10% | 0.80                | ±0.10       | ±0.10         | 3.5%   | (I)       |                  |            |
| C1608X7R562KFST | C1608X7R562KFT  | 1V, 1kHz       | 5.6                 | nF          | ±10% | 0.80                | ±0.10       | ±0.10         | 3.5%   | (I)       |                  |            |
| C1608X7R682KFST | C1608X7R682KFT  | 1V, 1kHz       | 6.8                 | nF          | ±10% | 0.80                | ±0.10       | ±0.10         | 3.5%   | (I)       |                  |            |
| C1608X7R822KFST | C1608X7R822KFT  | 1V, 1kHz       | 8.2                 | nF          | ±10% | 0.80                | ±0.10       | ±0.10         | 3.5%   | (I)       |                  |            |
| C1608X7R103KFST | C1608X7R103KFT  | 1V, 1kHz       | 10                  | nF          | ±10% | 0.80                | ±0.10       | ±0.10         | 3.5%   | (I)       |                  |            |

□ Tolerance Code: J=±5%, K=±10%, M=±20%; Special tolerance on the request.



| RV              | DARFON P/N      | DARFON P/N 2   | Measuring Condition | Capacitance |            | Available Tolerance | Thick. (mm) | Tolerance(mm) |        | DF (max.) | Standard Packing | Test Spec. |
|-----------------|-----------------|----------------|---------------------|-------------|------------|---------------------|-------------|---------------|--------|-----------|------------------|------------|
|                 |                 |                |                     | Value       | Unit       |                     |             | L/W           | Thick. |           |                  |            |
| 25V             | C1608X7R123KFTS | C1608X7R123KFT | 1V, 1kHz            | 12          | nF         | ±10%                | 0.80        | ±0.10         | ±0.10  | 3.5%      | Paper, 4Kpcs     | (I)        |
|                 | C1608X7R153KFTS | C1608X7R153KFT | 1V, 1kHz            | 15          | nF         | ±10%                | 0.80        | ±0.10         | ±0.10  | 3.5%      |                  | (I)        |
|                 | C1608X7R183KFTS | C1608X7R183KFT | 1V, 1kHz            | 18          | nF         | ±10%                | 0.80        | ±0.10         | ±0.10  | 3.5%      |                  | (I)        |
|                 | C1608X7R223□FTS | C1608X7R223□FT | 1V, 1kHz            | 22          | nF         | ±10%,±5%            | 0.80        | ±0.10         | ±0.10  | 3.5%      |                  | (I)        |
|                 | C1608X7R273□FTS | C1608X7R273□FT | 1V, 1kHz            | 27          | nF         | ±10%,±5%            | 0.80        | ±0.10         | ±0.10  | 3.5%      |                  | (I)        |
|                 | C1608X7R333KFTS | C1608X7R333KFT | 1V, 1kHz            | 33          | nF         | ±10%                | 0.80        | ±0.10         | ±0.10  | 3.5%      |                  | (I)        |
|                 | C1608X7R393KFTS | C1608X7R393KFT | 1V, 1kHz            | 39          | nF         | ±10%                | 0.80        | ±0.10         | ±0.10  | 3.5%      |                  | (I)        |
|                 | C1608X7R473KFTS | C1608X7R473KFT | 1V, 1kHz            | 47          | nF         | ±10%                | 0.80        | ±0.10         | ±0.10  | 3.5%      |                  | (I)        |
|                 | C1608X7R563KFTS | C1608X7R563KFT | 1V, 1kHz            | 56          | nF         | ±10%                | 0.80        | ±0.10         | ±0.10  | 3.5%      |                  | (I)        |
|                 | C1608X7R683KFTS | C1608X7R683KFT | 1V, 1kHz            | 68          | nF         | ±10%                | 0.80        | ±0.10         | ±0.10  | 3.5%      |                  | (I)        |
|                 | C1608X7R823KFTS | C1608X7R823KFT | 1V, 1kHz            | 82          | nF         | ±10%                | 0.80        | ±0.10         | ±0.10  | 3.5%      |                  | (I)        |
|                 | C1608X7R104KFTS | C1608X7R104KFT | 1V, 1kHz            | 100         | nF         | ±10%                | 0.80        | ±0.10         | ±0.10  | 3.5%      |                  | (I)        |
|                 | C1608X7R124KFTS | C1608X7R124KFT | 1V, 1kHz            | 120         | nF         | ±10%                | 0.80        | ±0.15         | ±0.15  | 3.5%      |                  | (I)        |
|                 | C1608X7R154KFTS | C1608X7R154KFT | 1V, 1kHz            | 150         | nF         | ±10%                | 0.80        | ±0.15         | ±0.15  | 3.5%      |                  | (I)        |
|                 | C1608X7R184KFTS | C1608X7R184KFT | 1V, 1kHz            | 180         | nF         | ±10%                | 0.80        | ±0.15         | ±0.15  | 3.5%      |                  | (I)        |
|                 | C1608X7R224KFTS | C1608X7R224KFT | 1V, 1kHz            | 220         | nF         | ±10%                | 0.80        | ±0.15         | ±0.15  | 3.5%      |                  | (I)        |
|                 | C1608X7R334KFTS | C1608X7R334KFT | 1V, 1kHz            | 330         | nF         | ±10%                | 0.80        | ±0.15         | ±0.15  | 7.0%      |                  | (I)        |
|                 | C1608X7R474KFTS | C1608X7R474KFT | 1V, 1kHz            | 470         | nF         | ±10%                | 0.80        | ±0.15         | ±0.15  | 10.0%     |                  | (I)        |
| C1608X7R105KFTS | C1608X7R105KFT  | 1V, 1kHz       | 1.0                 | uF          | ±10%       | 0.80                | ±0.15       | ±0.15         | 10.0%  | (II)      |                  |            |
| 16V             | C1608X7R101KETS | C1608X7R101KET | 1V, 1kHz            | 100         | pF         | ±10%                | 0.80        | ±0.10         | ±0.10  | 5.0%      | Paper, 4Kpcs     | (I)        |
|                 | C1608X7R121KETS | C1608X7R121KET | 1V, 1kHz            | 120         | pF         | ±10%                | 0.80        | ±0.10         | ±0.10  | 5.0%      |                  | (I)        |
|                 | C1608X7R151KETS | C1608X7R151KET | 1V, 1kHz            | 150         | pF         | ±10%                | 0.80        | ±0.10         | ±0.10  | 5.0%      |                  | (I)        |
|                 | C1608X7R181KETS | C1608X7R181KET | 1V, 1kHz            | 180         | pF         | ±10%                | 0.80        | ±0.10         | ±0.10  | 5.0%      |                  | (I)        |
|                 | C1608X7R221KETS | C1608X7R221KET | 1V, 1kHz            | 220         | pF         | ±10%                | 0.80        | ±0.10         | ±0.10  | 5.0%      |                  | (I)        |
|                 | C1608X7R271KETS | C1608X7R271KET | 1V, 1kHz            | 270         | pF         | ±10%                | 0.80        | ±0.10         | ±0.10  | 5.0%      |                  | (I)        |
|                 | C1608X7R331KETS | C1608X7R331KET | 1V, 1kHz            | 330         | pF         | ±10%                | 0.80        | ±0.10         | ±0.10  | 5.0%      |                  | (I)        |
|                 | C1608X7R391KETS | C1608X7R391KET | 1V, 1kHz            | 390         | pF         | ±10%                | 0.80        | ±0.10         | ±0.10  | 5.0%      |                  | (I)        |
|                 | C1608X7R471KETS | C1608X7R471KET | 1V, 1kHz            | 470         | pF         | ±10%                | 0.80        | ±0.10         | ±0.10  | 5.0%      |                  | (I)        |
|                 | C1608X7R561KETS | C1608X7R561KET | 1V, 1kHz            | 560         | pF         | ±10%                | 0.80        | ±0.10         | ±0.10  | 5.0%      |                  | (I)        |
|                 | C1608X7R681KETS | C1608X7R681KET | 1V, 1kHz            | 680         | pF         | ±10%                | 0.80        | ±0.10         | ±0.10  | 5.0%      |                  | (I)        |
|                 | C1608X7R821KETS | C1608X7R821KET | 1V, 1kHz            | 820         | pF         | ±10%                | 0.80        | ±0.10         | ±0.10  | 5.0%      |                  | (I)        |
|                 | C1608X7R102KETS | C1608X7R102KET | 1V, 1kHz            | 1.0         | nF         | ±10%                | 0.80        | ±0.10         | ±0.10  | 5.0%      |                  | (I)        |
|                 | C1608X7R122KETS | C1608X7R122KET | 1V, 1kHz            | 1.2         | nF         | ±10%                | 0.80        | ±0.10         | ±0.10  | 5.0%      |                  | (I)        |
|                 | C1608X7R152KETS | C1608X7R152KET | 1V, 1kHz            | 1.5         | nF         | ±10%                | 0.80        | ±0.10         | ±0.10  | 5.0%      |                  | (I)        |
|                 | C1608X7R182KETS | C1608X7R182KET | 1V, 1kHz            | 1.8         | nF         | ±10%                | 0.80        | ±0.10         | ±0.10  | 5.0%      |                  | (I)        |
|                 | C1608X7R222KETS | C1608X7R222KET | 1V, 1kHz            | 2.2         | nF         | ±10%                | 0.80        | ±0.10         | ±0.10  | 5.0%      |                  | (I)        |
|                 | C1608X7R272KETS | C1608X7R272KET | 1V, 1kHz            | 2.7         | nF         | ±10%                | 0.80        | ±0.10         | ±0.10  | 5.0%      |                  | (I)        |
|                 | C1608X7R332KETS | C1608X7R332KET | 1V, 1kHz            | 3.3         | nF         | ±10%                | 0.80        | ±0.10         | ±0.10  | 5.0%      |                  | (I)        |
|                 | C1608X7R392KETS | C1608X7R392KET | 1V, 1kHz            | 3.9         | nF         | ±10%                | 0.80        | ±0.10         | ±0.10  | 5.0%      |                  | (I)        |
|                 | C1608X7R472KETS | C1608X7R472KET | 1V, 1kHz            | 4.7         | nF         | ±10%                | 0.80        | ±0.10         | ±0.10  | 5.0%      |                  | (I)        |
|                 | C1608X7R562KETS | C1608X7R562KET | 1V, 1kHz            | 5.6         | nF         | ±10%                | 0.80        | ±0.10         | ±0.10  | 5.0%      |                  | (I)        |
|                 | C1608X7R682KETS | C1608X7R682KET | 1V, 1kHz            | 6.8         | nF         | ±10%                | 0.80        | ±0.10         | ±0.10  | 5.0%      |                  | (I)        |
|                 | C1608X7R822KETS | C1608X7R822KET | 1V, 1kHz            | 8.2         | nF         | ±10%                | 0.80        | ±0.10         | ±0.10  | 5.0%      |                  | (I)        |
|                 | C1608X7R103KETS | C1608X7R103KET | 1V, 1kHz            | 10          | nF         | ±10%                | 0.80        | ±0.10         | ±0.10  | 5.0%      |                  | (I)        |
|                 | C1608X7R123KETS | C1608X7R123KET | 1V, 1kHz            | 12          | nF         | ±10%                | 0.80        | ±0.10         | ±0.10  | 5.0%      |                  | (I)        |
|                 | C1608X7R153KETS | C1608X7R153KET | 1V, 1kHz            | 15          | nF         | ±10%                | 0.80        | ±0.10         | ±0.10  | 5.0%      |                  | (I)        |
|                 | C1608X7R183KETS | C1608X7R183KET | 1V, 1kHz            | 18          | nF         | ±10%                | 0.80        | ±0.10         | ±0.10  | 5.0%      |                  | (I)        |
|                 | C1608X7R223KETS | C1608X7R223KET | 1V, 1kHz            | 22          | nF         | ±10%                | 0.80        | ±0.10         | ±0.10  | 5.0%      |                  | (I)        |
|                 | C1608X7R273KETS | C1608X7R273KET | 1V, 1kHz            | 27          | nF         | ±10%                | 0.80        | ±0.10         | ±0.10  | 5.0%      |                  | (I)        |
|                 | C1608X7R333KETS | C1608X7R333KET | 1V, 1kHz            | 33          | nF         | ±10%                | 0.80        | ±0.10         | ±0.10  | 5.0%      |                  | (I)        |
|                 | C1608X7R393KETS | C1608X7R393KET | 1V, 1kHz            | 39          | nF         | ±10%                | 0.80        | ±0.10         | ±0.10  | 5.0%      |                  | (I)        |
|                 | C1608X7R473KETS | C1608X7R473KET | 1V, 1kHz            | 47          | nF         | ±10%                | 0.80        | ±0.10         | ±0.10  | 5.0%      |                  | (I)        |
|                 | C1608X7R563KETS | C1608X7R563KET | 1V, 1kHz            | 56          | nF         | ±10%                | 0.80        | ±0.10         | ±0.10  | 5.0%      |                  | (I)        |
|                 | C1608X7R683KETS | C1608X7R683KET | 1V, 1kHz            | 68          | nF         | ±10%                | 0.80        | ±0.10         | ±0.10  | 5.0%      |                  | (I)        |
|                 | C1608X7R823KETS | C1608X7R823KET | 1V, 1kHz            | 82          | nF         | ±10%                | 0.80        | ±0.10         | ±0.10  | 5.0%      |                  | (I)        |
| C1608X7R104KETS | C1608X7R104KET  | 1V, 1kHz       | 100                 | nF          | ±10%       | 0.80                | ±0.10       | ±0.10         | 5.0%   | (I)       |                  |            |
| C1608X7R154KETS | C1608X7R154KET  | 1V, 1kHz       | 150                 | nF          | ±10%       | 0.80                | ±0.10       | ±0.10         | 5.0%   | (I)       |                  |            |
| C1608X7R184KETS | C1608X7R184KET  | 1V, 1kHz       | 180                 | nF          | ±10%       | 0.80                | ±0.15       | ±0.15         | 5.0%   | (I)       |                  |            |
| C1608X7R224KETS | C1608X7R224KET  | 1V, 1kHz       | 220                 | nF          | ±10%       | 0.80                | ±0.15       | ±0.15         | 5.0%   | (I)       |                  |            |
| C1608X7R334KETS | C1608X7R334KET  | 1V, 1kHz       | 330                 | nF          | ±10%       | 0.80                | ±0.15       | ±0.15         | 5.0%   | (I)       |                  |            |
| C1608X7R474KETS | C1608X7R474KET  | 1V, 1kHz       | 470                 | nF          | ±10%       | 0.80                | ±0.15       | ±0.15         | 5.0%   | (I)       |                  |            |
| C1608X7R684KETS | C1608X7R684KET  | 1V, 1kHz       | 680                 | nF          | ±10%       | 0.80                | ±0.15       | ±0.15         | 10.0%  | (I)       |                  |            |
| C1608X7R105□ETS | C1608X7R105□ET  | 1V, 1kHz       | 1.0                 | uF          | ±10%, ±20% | 0.80                | ±0.15       | ±0.15         | 10.0%  | (II)      |                  |            |
| C1608X7R225KETS | C1608X7R225KET  | 1V, 1kHz       | 2.2                 | uF          | ±10%       | 0.80                | ±0.20       | ±0.20         | 10.0%  | (II)      |                  |            |

| RV              | DARFON P/N      | DARFON P/N 2   | Measuring Condition | Capacitance |      | Available Tolerance | Thick. (mm) | Tolerance(mm) |        | DF (max.) | Standard Packing | Test Spec. |
|-----------------|-----------------|----------------|---------------------|-------------|------|---------------------|-------------|---------------|--------|-----------|------------------|------------|
|                 |                 |                |                     | Value       | Unit |                     |             | L/W           | Thick. |           |                  |            |
| 10V             | C1608X7R101KDTS | C1608X7R101KDT | 1V, 1kHz            | 100         | pF   | ±10%                | 0.80        | ±0.10         | ±0.10  | 5.0%      | Paper, 4Kpcs     | (I)        |
|                 | C1608X7R121KDTS | C1608X7R121KDT | 1V, 1kHz            | 120         | pF   | ±10%                | 0.80        | ±0.10         | ±0.10  | 5.0%      |                  | (I)        |
|                 | C1608X7R151KDTS | C1608X7R151KDT | 1V, 1kHz            | 150         | pF   | ±10%                | 0.80        | ±0.10         | ±0.10  | 5.0%      |                  | (I)        |
|                 | C1608X7R181KDTS | C1608X7R181KDT | 1V, 1kHz            | 180         | pF   | ±10%                | 0.80        | ±0.10         | ±0.10  | 5.0%      |                  | (I)        |
|                 | C1608X7R221KDTS | C1608X7R221KDT | 1V, 1kHz            | 220         | pF   | ±10%                | 0.80        | ±0.10         | ±0.10  | 5.0%      |                  | (I)        |
|                 | C1608X7R271KDTS | C1608X7R271KDT | 1V, 1kHz            | 270         | pF   | ±10%                | 0.80        | ±0.10         | ±0.10  | 5.0%      |                  | (I)        |
|                 | C1608X7R331KDTS | C1608X7R331KDT | 1V, 1kHz            | 330         | pF   | ±10%                | 0.80        | ±0.10         | ±0.10  | 5.0%      |                  | (I)        |
|                 | C1608X7R391KDTS | C1608X7R391KDT | 1V, 1kHz            | 390         | pF   | ±10%                | 0.80        | ±0.10         | ±0.10  | 5.0%      |                  | (I)        |
|                 | C1608X7R471KDTS | C1608X7R471KDT | 1V, 1kHz            | 470         | pF   | ±10%                | 0.80        | ±0.10         | ±0.10  | 5.0%      |                  | (I)        |
|                 | C1608X7R561KDTS | C1608X7R561KDT | 1V, 1kHz            | 560         | pF   | ±10%                | 0.80        | ±0.10         | ±0.10  | 5.0%      |                  | (I)        |
|                 | C1608X7R681KDTS | C1608X7R681KDT | 1V, 1kHz            | 680         | pF   | ±10%                | 0.80        | ±0.10         | ±0.10  | 5.0%      |                  | (I)        |
|                 | C1608X7R821KDTS | C1608X7R821KDT | 1V, 1kHz            | 820         | pF   | ±10%                | 0.80        | ±0.10         | ±0.10  | 5.0%      |                  | (I)        |
|                 | C1608X7R102KDTS | C1608X7R102KDT | 1V, 1kHz            | 1.0         | nF   | ±10%                | 0.80        | ±0.10         | ±0.10  | 5.0%      |                  | (I)        |
|                 | C1608X7R122KDTS | C1608X7R122KDT | 1V, 1kHz            | 1.2         | nF   | ±10%                | 0.80        | ±0.10         | ±0.10  | 5.0%      |                  | (I)        |
|                 | C1608X7R152KDTS | C1608X7R152KDT | 1V, 1kHz            | 1.5         | nF   | ±10%                | 0.80        | ±0.10         | ±0.10  | 5.0%      |                  | (I)        |
|                 | C1608X7R182KDTS | C1608X7R182KDT | 1V, 1kHz            | 1.8         | nF   | ±10%                | 0.80        | ±0.10         | ±0.10  | 5.0%      |                  | (I)        |
|                 | C1608X7R222KDTS | C1608X7R222KDT | 1V, 1kHz            | 2.2         | nF   | ±10%                | 0.80        | ±0.10         | ±0.10  | 5.0%      |                  | (I)        |
|                 | C1608X7R272KDTS | C1608X7R272KDT | 1V, 1kHz            | 2.7         | nF   | ±10%                | 0.80        | ±0.10         | ±0.10  | 5.0%      |                  | (I)        |
|                 | C1608X7R332KDTS | C1608X7R332KDT | 1V, 1kHz            | 3.3         | nF   | ±10%                | 0.80        | ±0.10         | ±0.10  | 5.0%      |                  | (I)        |
|                 | C1608X7R392KDTS | C1608X7R392KDT | 1V, 1kHz            | 3.9         | nF   | ±10%                | 0.80        | ±0.10         | ±0.10  | 5.0%      |                  | (I)        |
|                 | C1608X7R472KDTS | C1608X7R472KDT | 1V, 1kHz            | 4.7         | nF   | ±10%                | 0.80        | ±0.10         | ±0.10  | 5.0%      |                  | (I)        |
|                 | C1608X7R562KDTS | C1608X7R562KDT | 1V, 1kHz            | 5.6         | nF   | ±10%                | 0.80        | ±0.10         | ±0.10  | 5.0%      |                  | (I)        |
|                 | C1608X7R682KDTS | C1608X7R682KDT | 1V, 1kHz            | 6.8         | nF   | ±10%                | 0.80        | ±0.10         | ±0.10  | 5.0%      |                  | (I)        |
|                 | C1608X7R822KDTS | C1608X7R822KDT | 1V, 1kHz            | 8.2         | nF   | ±10%                | 0.80        | ±0.10         | ±0.10  | 5.0%      |                  | (I)        |
|                 | C1608X7R103KDTS | C1608X7R103KDT | 1V, 1kHz            | 10          | nF   | ±10%                | 0.80        | ±0.10         | ±0.10  | 5.0%      |                  | (I)        |
|                 | C1608X7R123KDTS | C1608X7R123KDT | 1V, 1kHz            | 12          | nF   | ±10%                | 0.80        | ±0.10         | ±0.10  | 5.0%      |                  | (I)        |
|                 | C1608X7R153KDTS | C1608X7R153KDT | 1V, 1kHz            | 15          | nF   | ±10%                | 0.80        | ±0.10         | ±0.10  | 5.0%      |                  | (I)        |
|                 | C1608X7R183KDTS | C1608X7R183KDT | 1V, 1kHz            | 18          | nF   | ±10%                | 0.80        | ±0.10         | ±0.10  | 5.0%      |                  | (I)        |
|                 | C1608X7R223KDTS | C1608X7R223KDT | 1V, 1kHz            | 22          | nF   | ±10%                | 0.80        | ±0.10         | ±0.10  | 5.0%      |                  | (I)        |
|                 | C1608X7R273KDTS | C1608X7R273KDT | 1V, 1kHz            | 27          | nF   | ±10%                | 0.80        | ±0.10         | ±0.10  | 5.0%      |                  | (I)        |
|                 | C1608X7R333KDTS | C1608X7R333KDT | 1V, 1kHz            | 33          | nF   | ±10%                | 0.80        | ±0.10         | ±0.10  | 5.0%      |                  | (I)        |
|                 | C1608X7R393KDTS | C1608X7R393KDT | 1V, 1kHz            | 39          | nF   | ±10%                | 0.80        | ±0.10         | ±0.10  | 5.0%      |                  | (I)        |
|                 | C1608X7R473KDTS | C1608X7R473KDT | 1V, 1kHz            | 47          | nF   | ±10%                | 0.80        | ±0.10         | ±0.10  | 5.0%      |                  | (I)        |
| C1608X7R563KDTS | C1608X7R563KDT  | 1V, 1kHz       | 56                  | nF          | ±10% | 0.80                | ±0.10       | ±0.10         | 5.0%   | (I)       |                  |            |
| C1608X7R683KDTS | C1608X7R683KDT  | 1V, 1kHz       | 68                  | nF          | ±10% | 0.80                | ±0.10       | ±0.10         | 5.0%   | (I)       |                  |            |
| C1608X7R823KDTS | C1608X7R823KDT  | 1V, 1kHz       | 82                  | nF          | ±10% | 0.80                | ±0.10       | ±0.10         | 5.0%   | (I)       |                  |            |
| C1608X7R104KDTS | C1608X7R104KDT  | 1V, 1kHz       | 100                 | nF          | ±10% | 0.80                | ±0.10       | ±0.10         | 5.0%   | (I)       |                  |            |
| C1608X7R224KDTS | C1608X7R224KDT  | 1V, 1kHz       | 220                 | nF          | ±10% | 0.80                | ±0.15       | ±0.15         | 5.0%   | (I)       |                  |            |
| C1608X7R334KDTS | C1608X7R334KDT  | 1V, 1kHz       | 330                 | nF          | ±10% | 0.80                | ±0.15       | ±0.15         | 10.0%  | (I)       |                  |            |
| C1608X7R474KDTS | C1608X7R474KDT  | 1V, 1kHz       | 470                 | nF          | ±10% | 0.80                | ±0.15       | ±0.15         | 10.0%  | (I)       |                  |            |
| C1608X7R684KDTS | C1608X7R684KDT  | 1V, 1kHz       | 680                 | nF          | ±10% | 0.80                | ±0.15       | ±0.15         | 10.0%  | (I)       |                  |            |
| C1608X7R105KDTS | C1608X7R105KDT  | 1V, 1kHz       | 1.0                 | uF          | ±10% | 0.80                | ±0.15       | ±0.15         | 10.0%  | (II)      |                  |            |
| C1608X7R225KDTS | C1608X7R225KDT  | 1V, 1kHz       | 2.2                 | uF          | ±10% | 0.80                | ±0.15       | ±0.10         | 10.0%  | (II)      |                  |            |
| 6.3V            | C1608X7R104KCTS | C1608X7R104KCT | 1V, 1kHz            | 100         | nF   | ±10%                | 0.80        | ±0.10         | ±0.10  | 5.0%      | Paper, 4Kpcs     | (I)        |
|                 | C1608X7R105KCTS | C1608X7R105KCT | 1V, 1kHz            | 1.0         | uF   | ±10%                | 0.80        | ±0.15         | ±0.15  | 10.0%     |                  | (II)       |
|                 | C1608X7R225KCTS | C1608X7R225KCT | 1V, 1kHz            | 2.2         | uF   | ±10%                | 0.80        | ±0.15         | ±0.10  | 10.0%     |                  | (II)       |
|                 | C1608X7R475KCTS | C1608X7R475KCT | 1V, 1kHz            | 4.7         | uF   | ±10%                | 0.80        | ±0.20         | ±0.20  | 10.0%     |                  | (II)       |
|                 | C1608X7R106MCTS | C1608X7R106MCT | 0.5V, 1kHz          | 10          | uF   | ±20%                | 0.80        | ±0.20         | ±0.20  | 10.0%     |                  | (III)*     |

□ Tolerance Code: J=±5%, K=±10%, M=±20%; Special tolerance on the request.



● C2012X7R Series (EIA0805)

| RV  | DARFON P/N      | DARFON P/N 2   | Measuring Condition | Capacitance |      | Available Tolerance | Thick. (mm) | Tolerance(mm) |        | DF (max.) | Standard Packing | Test Spec.      |
|-----|-----------------|----------------|---------------------|-------------|------|---------------------|-------------|---------------|--------|-----------|------------------|-----------------|
|     |                 |                |                     | Value       | Unit |                     |             | L/W           | Thick. |           |                  |                 |
| 50V | C2012X7R101KGTS | C2012X7R101KGT | 1V, 1kHz            | 100         | pF   | ±10%                | 0.85        | ±0.15         | ±0.15  | 2.5%      | Paper, 4Kpcs     | (I)             |
|     | C2012X7R151KGTS | C2012X7R151KGT | 1V, 1kHz            | 150         | pF   | ±10%                | 0.60        | ±0.15         | ±0.15  | 2.5%      |                  | (I)             |
|     | C2012X7R181KGTS | C2012X7R181KGT | 1V, 1kHz            | 180         | pF   | ±10%                | 0.60        | ±0.15         | ±0.15  | 2.5%      |                  | (I)             |
|     | C2012X7R221KGTS | C2012X7R221KGT | 1V, 1kHz            | 220         | pF   | ±10%                | 0.60        | ±0.15         | ±0.15  | 2.5%      |                  | (I)             |
|     | C2012X7R271KGTS | C2012X7R271KGT | 1V, 1kHz            | 270         | pF   | ±10%                | 0.60        | ±0.15         | ±0.15  | 2.5%      |                  | (I)             |
|     | C2012X7R331KGTS | C2012X7R331KGT | 1V, 1kHz            | 330         | pF   | ±10%                | 0.60        | ±0.15         | ±0.15  | 2.5%      |                  | (I)             |
|     | C2012X7R391KGTS | C2012X7R391KGT | 1V, 1kHz            | 390         | pF   | ±10%                | 0.60        | ±0.15         | ±0.15  | 2.5%      |                  | (I)             |
|     | C2012X7R471KGTS | C2012X7R471KGT | 1V, 1kHz            | 470         | pF   | ±10%                | 0.60        | ±0.15         | ±0.15  | 2.5%      |                  | (I)             |
|     | C2012X7R561KGTS | C2012X7R561KGT | 1V, 1kHz            | 560         | pF   | ±10%                | 0.60        | ±0.15         | ±0.15  | 2.5%      |                  | (I)             |
|     | C2012X7R681KGTS | C2012X7R681KGT | 1V, 1kHz            | 680         | pF   | ±10%                | 0.60        | ±0.15         | ±0.15  | 2.5%      |                  | (I)             |
|     | C2012X7R821KGTS | C2012X7R821KGT | 1V, 1kHz            | 820         | pF   | ±10%                | 0.60        | ±0.15         | ±0.15  | 2.5%      |                  | (I)             |
|     | C2012X7R102KGTS | C2012X7R102KGT | 1V, 1kHz            | 1.0         | nF   | ±10%                | 0.60        | ±0.15         | ±0.15  | 2.5%      |                  | (I)             |
|     | C2012X7R122KGTS | C2012X7R122KGT | 1V, 1kHz            | 1.2         | nF   | ±10%                | 0.60        | ±0.15         | ±0.15  | 2.5%      |                  | (I)             |
|     | C2012X7R152KGTS | C2012X7R152KGT | 1V, 1kHz            | 1.5         | nF   | ±10%                | 0.60        | ±0.15         | ±0.15  | 2.5%      |                  | (I)             |
|     | C2012X7R182KGTS | C2012X7R182KGT | 1V, 1kHz            | 1.8         | nF   | ±10%                | 0.60        | ±0.15         | ±0.15  | 2.5%      |                  | (I)             |
|     | C2012X7R222KGTS | C2012X7R222KGT | 1V, 1kHz            | 2.2         | nF   | ±10%                | 0.60        | ±0.15         | ±0.15  | 2.5%      |                  | (I)             |
|     | C2012X7R272KGTS | C2012X7R272KGT | 1V, 1kHz            | 2.7         | nF   | ±10%                | 0.60        | ±0.15         | ±0.15  | 2.5%      |                  | (I)             |
|     | C2012X7R332KGTS | C2012X7R332KGT | 1V, 1kHz            | 3.3         | nF   | ±10%                | 0.60        | ±0.15         | ±0.15  | 2.5%      |                  | (I)             |
|     | C2012X7R392KGTS | C2012X7R392KGT | 1V, 1kHz            | 3.9         | nF   | ±10%                | 0.60        | ±0.15         | ±0.15  | 2.5%      |                  | (I)             |
|     | C2012X7R472KGTS | C2012X7R472KGT | 1V, 1kHz            | 4.7         | nF   | ±10%                | 0.60        | ±0.15         | ±0.15  | 2.5%      |                  | (I)             |
|     | C2012X7R562KGTS | C2012X7R562KGT | 1V, 1kHz            | 5.6         | nF   | ±10%                | 0.60        | ±0.15         | ±0.15  | 2.5%      |                  | (I)             |
|     | C2012X7R682KGTS | C2012X7R682KGT | 1V, 1kHz            | 6.8         | nF   | ±10%                | 0.60        | ±0.15         | ±0.15  | 2.5%      |                  | (I)             |
|     | C2012X7R822KGTS | C2012X7R822KGT | 1V, 1kHz            | 8.2         | nF   | ±10%                | 0.60        | ±0.15         | ±0.15  | 2.5%      |                  | (I)             |
|     | C2012X7R103KGTS | C2012X7R103KGT | 1V, 1kHz            | 10          | nF   | ±10%                | 0.60        | ±0.15         | ±0.15  | 2.5%      |                  | (I)             |
|     | C2012X7R123KGTS | C2012X7R123KGT | 1V, 1kHz            | 12          | nF   | ±10%                | 0.60        | ±0.15         | ±0.15  | 2.5%      |                  | (I)             |
|     | C2012X7R153KGTS | C2012X7R153KGT | 1V, 1kHz            | 15          | nF   | ±10%                | 0.60        | ±0.15         | ±0.15  | 2.5%      |                  | (I)             |
|     | C2012X7R183KGTS | C2012X7R183KGT | 1V, 1kHz            | 18          | nF   | ±10%                | 0.60        | ±0.15         | ±0.15  | 2.5%      |                  | (I)             |
|     | C2012X7R223KGTS | C2012X7R223KGT | 1V, 1kHz            | 22          | nF   | ±10%                | 0.60        | ±0.15         | ±0.15  | 2.5%      |                  | (I)             |
|     | C2012X7R273KGTS | C2012X7R273KGT | 1V, 1kHz            | 27          | nF   | ±10%                | 0.60        | ±0.15         | ±0.15  | 2.5%      |                  | (I)             |
|     | C2012X7R333KGTS | C2012X7R333KGT | 1V, 1kHz            | 33          | nF   | ±10%                | 0.60        | ±0.15         | ±0.15  | 2.5%      |                  | (I)             |
|     | C2012X7R393KGTS | C2012X7R393KGT | 1V, 1kHz            | 39          | nF   | ±10%                | 0.60        | ±0.15         | ±0.15  | 2.5%      |                  | (I)             |
|     | C2012X7R473KGTS | C2012X7R473KGT | 1V, 1kHz            | 47          | nF   | ±10%                | 0.60        | ±0.15         | ±0.15  | 2.5%      |                  | (I)             |
|     | C2012X7R563KGTS | C2012X7R563KGT | 1V, 1kHz            | 56          | nF   | ±10%                | 0.60        | ±0.15         | ±0.15  | 2.5%      |                  | (I)             |
|     | C2012X7R683KGTS | C2012X7R683KGT | 1V, 1kHz            | 68          | nF   | ±10%                | 0.60        | ±0.15         | ±0.15  | 2.5%      |                  | (I)             |
|     | C2012X7R823KGTS | C2012X7R823KGT | 1V, 1kHz            | 82          | nF   | ±10%                | 0.60        | ±0.15         | ±0.15  | 2.5%      |                  | (I)             |
|     | C2012X7R104KGTS | C2012X7R104KGT | 1V, 1kHz            | 100         | nF   | ±10%,±5%            | 0.80        | ±0.15         | ±0.10  | 2.5%      |                  | (I)             |
|     | C2012X7R124KGTS | C2012X7R124KGT | 1V, 1kHz            | 120         | nF   | ±10%                | 0.85        | ±0.15         | ±0.15  | 2.5%      |                  | (I)             |
|     | C2012X7R154KGTS | C2012X7R154KGT | 1V, 1kHz            | 150         | nF   | ±10%                | 0.85        | ±0.15         | ±0.15  | 2.5%      |                  | (I)             |
|     | C2012X7R184KGTS | C2012X7R184KGT | 1V, 1kHz            | 180         | nF   | ±10%                | 1.25        | ±0.15         | ±0.20  | 3.0%      |                  | Embossed, 3Kpcs |
|     | C2012X7R224KGTS | C2012X7R224KGT | 1V, 1kHz            | 220         | nF   | ±10%                | 0.85        | ±0.15         | ±0.15  | 3.0%      |                  | Paper, 4Kpcs    |
|     | C2012X7R224KGPS | C2012X7R224KGP | 1V, 1kHz            | 220         | nF   | ±10%                | 1.25        | ±0.15         | ±0.20  | 3.0%      |                  |                 |
|     | C2012X7R334KGTS | C2012X7R334KGT | 1V, 1kHz            | 330         | nF   | ±10%                | 1.25        | ±0.15         | ±0.20  | 3.0%      |                  | Embossed, 3Kpcs |
|     | C2012X7R474KGPS | C2012X7R474KGP | 1V, 1kHz            | 470         | nF   | ±10%                | 1.25        | ±0.15         | ±0.20  | 3.5%      |                  |                 |
|     | C2012X7R105KGPS | C2012X7R105KGP | 1V, 1kHz            | 1.0         | uF   | ±10%                | 1.25        | ±0.15         | ±0.20  | 10.0%     |                  |                 |
|     | C2012X7R225KGPS | C2012X7R225KGP | 1V, 1kHz            | 2.2         | uF   | ±10%                | 1.25        | ±0.20         | ±0.20  | 10.0%     |                  | (II)            |

MLCC

General Purpose

| RV               | DARFON P/N       | DARFON P/N 2   | Measuring Condition | Capacitance Value | Unit       | Available Tolerance | Thick. (mm) | Tolerance(mm) |        | DF (max.) | Standard Packing | Test Spec. |
|------------------|------------------|----------------|---------------------|-------------------|------------|---------------------|-------------|---------------|--------|-----------|------------------|------------|
|                  |                  |                |                     |                   |            |                     |             | L/W           | Thick. |           |                  |            |
| 35V              | C2012X7R474KNPS  | C2012X7R474KNP | 1V, 1kHz            | 470               | nF         | ±10%                | 1.25        | ±0.15         | ±0.20  | 3.5%      | Embossed, 3Kpcs  | (I)        |
|                  | C2012X7R102KFTSC |                | 1V, 1kHz            | 1.0               | nF         | ±10%                | 0.60        | ±0.15         | ±0.15  | 3.5%      |                  | (I)        |
|                  | C2012X7R102KFTS  | C2012X7R102KFT | 1V, 1kHz            | 1.0               | nF         | ±10%                | 0.85        | ±0.15         | ±0.15  | 3.5%      |                  | (I)        |
|                  | C2012X7R122KFTSC |                | 1V, 1kHz            | 1.2               | nF         | ±10%                | 0.60        | ±0.15         | ±0.15  | 3.5%      |                  | (I)        |
|                  | C2012X7R122KFTS  | C2012X7R122KFT | 1V, 1kHz            | 1.2               | nF         | ±10%                | 0.85        | ±0.15         | ±0.15  | 3.5%      |                  | (I)        |
|                  | C2012X7R152KFTSC |                | 1V, 1kHz            | 1.5               | nF         | ±10%                | 0.60        | ±0.15         | ±0.15  | 3.5%      |                  | (I)        |
|                  | C2012X7R152KFTS  | C2012X7R152KFT | 1V, 1kHz            | 1.5               | nF         | ±10%                | 0.85        | ±0.15         | ±0.15  | 3.5%      |                  | (I)        |
|                  | C2012X7R182KFTSC |                | 1V, 1kHz            | 1.8               | nF         | ±10%                | 0.60        | ±0.15         | ±0.15  | 3.5%      |                  | (I)        |
|                  | C2012X7R182KFTS  | C2012X7R182KFT | 1V, 1kHz            | 1.8               | nF         | ±10%                | 0.85        | ±0.15         | ±0.15  | 3.5%      |                  | (I)        |
|                  | C2012X7R222KFTSC |                | 1V, 1kHz            | 2.2               | nF         | ±10%                | 0.60        | ±0.15         | ±0.15  | 3.5%      |                  | (I)        |
|                  | C2012X7R222KFTS  | C2012X7R222KFT | 1V, 1kHz            | 2.2               | nF         | ±10%                | 0.85        | ±0.15         | ±0.15  | 3.5%      |                  | (I)        |
|                  | C2012X7R272KFTSC |                | 1V, 1kHz            | 2.7               | nF         | ±10%                | 0.60        | ±0.15         | ±0.15  | 3.5%      |                  | (I)        |
|                  | C2012X7R272KFTS  | C2012X7R272KFT | 1V, 1kHz            | 2.7               | nF         | ±10%                | 0.85        | ±0.15         | ±0.15  | 3.5%      |                  | (I)        |
|                  | C2012X7R332KFTSC |                | 1V, 1kHz            | 3.3               | nF         | ±10%                | 0.60        | ±0.15         | ±0.15  | 3.5%      |                  | (I)        |
|                  | C2012X7R332KFTS  | C2012X7R332KFT | 1V, 1kHz            | 3.3               | nF         | ±10%                | 0.85        | ±0.15         | ±0.15  | 3.5%      |                  | (I)        |
|                  | C2012X7R392KFTSC |                | 1V, 1kHz            | 3.9               | nF         | ±10%                | 0.60        | ±0.15         | ±0.15  | 3.5%      |                  | (I)        |
|                  | C2012X7R392KFTS  | C2012X7R392KFT | 1V, 1kHz            | 3.9               | nF         | ±10%                | 0.85        | ±0.15         | ±0.15  | 3.5%      |                  | (I)        |
|                  | C2012X7R472KFTSC |                | 1V, 1kHz            | 4.7               | nF         | ±10%                | 0.60        | ±0.15         | ±0.15  | 3.5%      |                  | (I)        |
|                  | C2012X7R472KFTS  | C2012X7R472KFT | 1V, 1kHz            | 4.7               | nF         | ±10%                | 0.85        | ±0.15         | ±0.15  | 3.5%      |                  | (I)        |
|                  | C2012X7R562KFTSC |                | 1V, 1kHz            | 5.6               | nF         | ±10%                | 0.60        | ±0.15         | ±0.15  | 3.5%      |                  | (I)        |
|                  | C2012X7R562KFTS  | C2012X7R562KFT | 1V, 1kHz            | 5.6               | nF         | ±10%                | 0.85        | ±0.15         | ±0.15  | 3.5%      |                  | (I)        |
|                  | C2012X7R682KFTSC |                | 1V, 1kHz            | 6.8               | nF         | ±10%                | 0.60        | ±0.15         | ±0.15  | 3.5%      |                  | (I)        |
|                  | C2012X7R682KFTS  | C2012X7R682KFT | 1V, 1kHz            | 6.8               | nF         | ±10%                | 0.85        | ±0.15         | ±0.15  | 3.5%      |                  | (I)        |
|                  | C2012X7R822KFTSC |                | 1V, 1kHz            | 8.2               | nF         | ±10%                | 0.60        | ±0.15         | ±0.15  | 3.5%      |                  | (I)        |
|                  | C2012X7R103KFTSC |                | 1V, 1kHz            | 10                | nF         | ±10%                | 0.60        | ±0.15         | ±0.15  | 3.5%      |                  | (I)        |
|                  | C2012X7R103KFTS  | C2012X7R103KFT | 1V, 1kHz            | 10                | nF         | ±10%                | 0.85        | ±0.15         | ±0.15  | 3.5%      |                  | (I)        |
|                  | C2012X7R123KFTSC |                | 1V, 1kHz            | 12                | nF         | ±10%                | 0.60        | ±0.15         | ±0.15  | 3.5%      |                  | (I)        |
|                  | C2012X7R123KFTS  | C2012X7R123KFT | 1V, 1kHz            | 12                | nF         | ±10%                | 0.85        | ±0.15         | ±0.15  | 3.5%      |                  | (I)        |
|                  | C2012X7R153KFTSC |                | 1V, 1kHz            | 15                | nF         | ±10%                | 0.60        | ±0.15         | ±0.15  | 3.5%      |                  | (I)        |
|                  | C2012X7R153KFTS  | C2012X7R153KFT | 1V, 1kHz            | 15                | nF         | ±10%                | 0.85        | ±0.15         | ±0.15  | 3.5%      |                  | (I)        |
|                  | C2012X7R183KFTSC |                | 1V, 1kHz            | 18                | nF         | ±10%                | 0.60        | ±0.15         | ±0.15  | 3.5%      |                  | (I)        |
|                  | C2012X7R183KFTS  | C2012X7R183KFT | 1V, 1kHz            | 18                | nF         | ±10%                | 0.85        | ±0.15         | ±0.15  | 3.5%      |                  | (I)        |
|                  | C2012X7R223KFTSC |                | 1V, 1kHz            | 22                | nF         | ±10%                | 0.60        | ±0.15         | ±0.15  | 3.5%      |                  | (I)        |
|                  | C2012X7R223KFTS  | C2012X7R223KFT | 1V, 1kHz            | 22                | nF         | ±10%                | 0.85        | ±0.15         | ±0.15  | 3.5%      |                  | (I)        |
|                  | C2012X7R273KFTSC |                | 1V, 1kHz            | 27                | nF         | ±10%                | 0.60        | ±0.15         | ±0.15  | 3.5%      |                  | (I)        |
| C2012X7R273KFTS  | C2012X7R273KFT   | 1V, 1kHz       | 27                  | nF                | ±10%       | 0.85                | ±0.15       | ±0.15         | 3.5%   | (I)       |                  |            |
| C2012X7R333KFTSC |                  | 1V, 1kHz       | 33                  | nF                | ±10%       | 0.60                | ±0.15       | ±0.15         | 3.5%   | (I)       |                  |            |
| C2012X7R333KFTS  | C2012X7R333KFT   | 1V, 1kHz       | 33                  | nF                | ±10%       | 0.85                | ±0.15       | ±0.15         | 3.5%   | (I)       |                  |            |
| C2012X7R393KFTSC |                  | 1V, 1kHz       | 39                  | nF                | ±10%       | 0.60                | ±0.15       | ±0.15         | 3.5%   | (I)       |                  |            |
| C2012X7R393KFTS  | C2012X7R393KFT   | 1V, 1kHz       | 39                  | nF                | ±10%       | 0.85                | ±0.15       | ±0.15         | 3.5%   | (I)       |                  |            |
| C2012X7R473KFTS  | C2012X7R473KFT   | 1V, 1kHz       | 47                  | nF                | ±10%       | 0.85                | ±0.15       | ±0.15         | 3.5%   | (I)       |                  |            |
| C2012X7R563KFTS  | C2012X7R563KFT   | 1V, 1kHz       | 56                  | nF                | ±10%       | 0.85                | ±0.15       | ±0.15         | 3.5%   | (I)       |                  |            |
| C2012X7R683KFTS  | C2012X7R683KFT   | 1V, 1kHz       | 68                  | nF                | ±10%       | 0.85                | ±0.15       | ±0.15         | 3.5%   | (I)       |                  |            |
| C2012X7R823KFTS  | C2012X7R823KFT   | 1V, 1kHz       | 82                  | nF                | ±10%       | 0.85                | ±0.15       | ±0.15         | 3.5%   | (I)       |                  |            |
| C2012X7R104KFTS  | C2012X7R104KFT   | 1V, 1kHz       | 100                 | nF                | ±10%       | 0.85                | ±0.15       | ±0.15         | 3.5%   | (I)       |                  |            |
| C2012X7R124KFTS  | C2012X7R124KFT   | 1V, 1kHz       | 120                 | nF                | ±10%       | 0.85                | ±0.15       | ±0.15         | 3.5%   | (I)       |                  |            |
| C2012X7R154KFTS  | C2012X7R154KFT   | 1V, 1kHz       | 150                 | nF                | ±10%       | 0.85                | ±0.15       | ±0.15         | 3.5%   | (I)       |                  |            |
| C2012X7R184KFTS  | C2012X7R184KFT   | 1V, 1kHz       | 180                 | nF                | ±10%       | 0.85                | ±0.15       | ±0.20         | 3.5%   | (I)       |                  |            |
| C2012X7R224KFTS  | C2012X7R224KFT   | 1V, 1kHz       | 220                 | nF                | ±10%       | 0.85                | ±0.15       | ±0.15         | 3.5%   | (I)       |                  |            |
| C2012X7R334KFPS  | C2012X7R334KFP   | 1V, 1kHz       | 330                 | nF                | ±10%       | 1.25                | ±0.15       | ±0.20         | 5.0%   | (I)       |                  |            |
| C2012X7R474KFPS  | C2012X7R474KFP   | 1V, 1kHz       | 470                 | nF                | ±10%       | 1.25                | ±0.15       | ±0.20         | 5.0%   | (I)       |                  |            |
| C2012X7R105□FPS  | C2012X7R105□FP   | 1V, 1kHz       | 1.0                 | uF                | ±10%, ±20% | 1.25                | ±0.15       | ±0.15         | 10.0%  | (II)      |                  |            |
| C2012X7R225KFPS  | C2012X7R225KFP   | 1V, 1kHz       | 2.2                 | uF                | ±10%       | 1.25                | ±0.15       | ±0.20         | 10.0%  | (II)      |                  |            |
| C2012X7R475KFPS  | C2012X7R475KFP   | 1V, 1kHz       | 4.7                 | uF                | ±10%       | 1.25                | ±0.15       | ±0.15         | 12.5%  | (II)*     |                  |            |
| C2012X7R123KETS  | C2012X7R123KET   | 1V, 1kHz       | 12                  | nF                | ±10%       | 0.85                | ±0.15       | ±0.15         | 3.5%   | (I)       |                  |            |
| C2012X7R104KETS  | C2012X7R104KET   | 1V, 1kHz       | 100                 | nF                | ±10%       | 0.85                | ±0.15       | ±0.15         | 3.5%   | (I)       |                  |            |
| C2012X7R224KETS  | C2012X7R224KET   | 1V, 1kHz       | 220                 | nF                | ±10%       | 0.85                | ±0.15       | ±0.15         | 3.5%   | (I)       |                  |            |
| C2012X7R224KEPS  | C2012X7R224KEP   | 1V, 1kHz       | 220                 | nF                | ±10%       | 1.25                | ±0.15       | ±0.20         | 3.0%   | (I)       |                  |            |
| C2012X7R334KEPS  | C2012X7R334KEP   | 1V, 1kHz       | 330                 | nF                | ±10%       | 1.25                | ±0.15       | ±0.20         | 5.0%   | (I)       |                  |            |
| C2012X7R474KEPS  | C2012X7R474KEP   | 1V, 1kHz       | 470                 | nF                | ±10%       | 1.25                | ±0.15       | ±0.20         | 5.0%   | (I)       |                  |            |
| C2012X7R684KEPS  | C2012X7R684KEP   | 1V, 1kHz       | 680                 | nF                | ±10%       | 1.25                | ±0.15       | ±0.10         | 5.0%   | (I)       |                  |            |
| C2012X7R105□EPS  | C2012X7R105□EP   | 1V, 1kHz       | 1.0                 | uF                | ±10%, ±20% | 1.25                | ±0.15       | ±0.20         | 5.0%   | (I)       |                  |            |
| C2012X7R225KEPS  | C2012X7R225KEP   | 1V, 1kHz       | 2.2                 | uF                | ±10%       | 1.25                | ±0.15       | ±0.20         | 10.0%  | (I)       |                  |            |
| C2012X7R475KEPS  | C2012X7R475KEP   | 1V, 1kHz       | 4.7                 | uF                | ±10%       | 1.25                | ±0.15       | ±0.20         | 10.0%  | (II)      |                  |            |
| C2012X7R105□DPS  | C2012X7R105□DP   | 1V, 1kHz       | 1.0                 | uF                | ±10%, ±20% | 1.25                | ±0.15       | ±0.20         | 5.0%   | (I)       |                  |            |
| C2012X7R225KDPS  | C2012X7R225KDP   | 1V, 1kHz       | 2.2                 | uF                | ±10%       | 1.25                | ±0.15       | ±0.20         | 10.0%  | (II)      |                  |            |
| C2012X7R475KDPS  | C2012X7R475KDP   | 1V, 1kHz       | 4.7                 | uF                | ±10%       | 1.25                | ±0.15       | ±0.20         | 10.0%  | (II)      |                  |            |
| C2012X7R106KDPS  | C2012X7R106KDP   | 1V, 1kHz       | 10                  | uF                | ±10%       | 1.25                | ±0.15       | ±0.20         | 10.0%  | (II)      |                  |            |
| C2012X7R475KCPS  | C2012X7R475KCP   | 1V, 1kHz       | 4.7                 | uF                | ±10%       | 1.25                | ±0.15       | ±0.20         | 10.0%  | (II)      |                  |            |
| C2012X7R106□CPS  | C2012X7R106□CP   | 1V, 1kHz       | 10                  | uF                | ±10%, ±20% | 1.25                | ±0.15       | ±0.20         | 15.0%  | (II)      |                  |            |
| C2012X7R106□BPS  | C2012X7R106□BP   | 1V, 1kHz       | 10                  | uF                | ±10%, ±20% | 1.25                | ±0.15       | ±0.20         | 15.0%  | (II)      |                  |            |

● C3216X7R Series (EIA1206)

| RV               | DARFON P/N       | DARFON P/N 2   | Measuring Condition | Capacitance |            | Available Tolerance | Thick. (mm) | Tolerance(mm) |           | DF (max.)       | Standard Packing | Test Spec. |
|------------------|------------------|----------------|---------------------|-------------|------------|---------------------|-------------|---------------|-----------|-----------------|------------------|------------|
|                  |                  |                |                     | Value       | Unit       |                     |             | LW            | Thick.    |                 |                  |            |
| 50V              | C3216X7R102KGTS  | C3216X7R102KGT | 1V, 1kHz            | 1.0         | nF         | ±10%                | 0.85        | ±0.15         | ±0.10     | 3.5%            | Paper, 4Kpcs     | (I)        |
|                  | C3216X7R562□GTS  | C3216X7R562□GT | 1V, 1kHz            | 5.6         | nF         | ±5%, ±10%           | 0.85        | ±0.15         | ±0.10     | 3.5%            |                  | (I)        |
|                  | C3216X7R103□GTS  | C3216X7R103□GT | 1V, 1kHz            | 10          | nF         | ±10%, ±20%          | 0.85        | ±0.15         | ±0.10     | 3.5%            |                  | (I)        |
|                  | C3216X7R123KGTS  | C3216X7R123KGT | 1V, 1kHz            | 12          | nF         | ±10%                | 0.85        | ±0.15         | ±0.10     | 3.5%            |                  | (I)        |
|                  | C3216X7R153KGTS  | C3216X7R153KGT | 1V, 1kHz            | 15          | nF         | ±10%                | 0.85        | ±0.15         | ±0.10     | 3.5%            |                  | (I)        |
|                  | C3216X7R183KGTS  | C3216X7R183KGT | 1V, 1kHz            | 18          | nF         | ±10%                | 0.85        | ±0.15         | ±0.10     | 3.5%            |                  | (I)        |
|                  | C3216X7R223KGTS  | C3216X7R223KGT | 1V, 1kHz            | 22          | nF         | ±10%                | 0.85        | ±0.15         | ±0.10     | 3.5%            |                  | (I)        |
|                  | C3216X7R273KGTS  | C3216X7R273KGT | 1V, 1kHz            | 27          | nF         | ±10%                | 0.85        | ±0.15         | ±0.10     | 3.5%            |                  | (I)        |
|                  | C3216X7R333KGTS  | C3216X7R333KGT | 1V, 1kHz            | 33          | nF         | ±10%                | 0.85        | ±0.15         | ±0.10     | 3.5%            |                  | (I)        |
|                  | C3216X7R393KGTS  | C3216X7R393KGT | 1V, 1kHz            | 39          | nF         | ±10%                | 0.85        | ±0.15         | ±0.10     | 3.5%            |                  | (I)        |
|                  | C3216X7R473KGTS  | C3216X7R473KGT | 1V, 1kHz            | 47          | nF         | ±10%                | 0.85        | ±0.15         | ±0.10     | 3.5%            |                  | (I)        |
|                  | C3216X7R563KGTS  | C3216X7R563KGT | 1V, 1kHz            | 56          | nF         | ±10%                | 0.85        | ±0.15         | ±0.10     | 3.5%            |                  | (I)        |
|                  | C3216X7R683KGTS  | C3216X7R683KGT | 1V, 1kHz            | 68          | nF         | ±10%                | 0.85        | ±0.15         | ±0.10     | 3.5%            |                  | (I)        |
|                  | C3216X7R823KGTS  | C3216X7R823KGT | 1V, 1kHz            | 82          | nF         | ±10%                | 0.85        | ±0.15         | ±0.10     | 3.5%            | (I)              |            |
|                  | C3216X7R104KGTS  | C3216X7R104KGT | 1V, 1kHz            | 100         | nF         | ±10%                | 0.85        | ±0.15         | ±0.10     | 3.5%            | (I)              |            |
|                  | C3216X7R224KGPS  | C3216X7R224KGP | 1V, 1kHz            | 220         | nF         | ±10%                | 0.95        | ±0.15         | ±0.10     | 3.5%            | (I)              |            |
|                  | C3216X7R334□GPS  | C3216X7R334□GP | 1V, 1kHz            | 330         | nF         | ±5%, ±10%           | 1.25        | ±0.15         | ±0.15     | 3.5%            | Embossed, 3Kpcs  | (I)        |
|                  | C3216X7R474KGPS  | C3216X7R474KGP | 1V, 1kHz            | 470         | nF         | ±10%                | 1.25        | ±0.15         | ±0.15     | 3.5%            | (I)              |            |
|                  | C3216X7R474KGPS  | C3216X7R474KGP | 1V, 1kHz            | 470         | nF         | ±10%                | 1.60        | ±0.15         | ±0.20     | 3.5%            | Embossed, 2Kpcs  | (I)        |
|                  | C3216X7R684KGPS  | C3216X7R684KGP | 1V, 1kHz            | 680         | nF         | ±10%                | 1.60        | +0.3/-0.1     | +0.3/-0.1 | 3.5%            | (I)              |            |
| C3216X7R105KGPS  | C3216X7R105KGP   | 1V, 1kHz       | 1.0                 | uF          | ±10%       | 1.25                | ±0.15       | ±0.15         | 3.5%      | Embossed, 3Kpcs | (I)              |            |
| C3216X7R105KGPS  | C3216X7R105KGP   | 1V, 1kHz       | 1.0                 | uF          | ±10%       | 1.60                | ±0.30       | ±0.30         | 3.5%      | (I)             |                  |            |
| C3216X7R225KGPSL | C3216X7R225KGP   | 1V, 1kHz       | 2.2                 | uF          | ±10%       | 1.60                | ±0.20       | ±0.20         | 10.0%     | Embossed, 2Kpcs | (II)             |            |
| C3216X7R475KGPS  | C3216X7R475KGP   | 1V, 1kHz       | 4.7                 | uF          | ±10%       | 1.60                | ±0.30       | ±0.30         | 10.0%     | (II)            |                  |            |
| C3216X7R106KGPSL | C3216X7R106KGP   | 1V, 1kHz       | 10                  | uF          | ±10%       | 1.60                | ±0.20       | ±0.20         | 10.0%     | (II)            |                  |            |
| 35V              | C3216X7R106KNPSL | C3216X7R106KNP | 1V, 1kHz            | 10          | uF         | ±10%                | 1.60        | ±0.20         | ±0.20     | 10.0%           | Embossed, 2Kpcs  | (II)       |
| 25V              | C3216X7R224KFPS  | C3216X7R224KFP | 1V, 1kHz            | 220         | nF         | ±10%                | 0.95        | ±0.15         | ±0.10     | 3.5%            | Embossed, 3Kpcs  | (I)        |
|                  | C3216X7R334KFPS  | C3216X7R334KFP | 1V, 1kHz            | 330         | nF         | ±10%                | 0.95        | ±0.15         | ±0.10     | 3.5%            |                  | (I)        |
|                  | C3216X7R474KFPS  | C3216X7R474KFP | 1V, 1kHz            | 470         | nF         | ±10%                | 1.25        | ±0.15         | ±0.20     | 3.5%            |                  | (I)        |
|                  | C3216X7R105□FPS  | C3216X7R105□FP | 1V, 1kHz            | 1.0         | uF         | ±10%, ±20%          | 1.25        | ±0.15         | ±0.20     | 3.5%            | (I)              |            |
|                  | C3216X7R225KFPS  | C3216X7R225KFP | 1V, 1kHz            | 2.2         | uF         | ±10%                | 1.60        | ±0.30         | ±0.30     | 5.0%            | (I)              |            |
|                  | C3216X7R475KFPS  | C3216X7R475KFP | 1V, 1kHz            | 4.7         | uF         | ±10%                | 1.60        | ±0.30         | ±0.30     | 10.0%           | Embossed, 2Kpcs  | (I)        |
| C3216X7R106KFPS  | C3216X7R106KFP   | 1V, 1kHz       | 10                  | uF          | ±10%       | 1.60                | ±0.30       | ±0.30         | 10.0%     | (II)            |                  |            |
| 16V              | C3216X7R104KETS  | C3216X7R104KET | 1V, 1kHz            | 100         | nF         | ±10%                | 0.85        | ±0.15         | ±0.10     | 3.5%            | Paper, 4Kpcs     | (I)        |
|                  | C3216X7R474KEPS  | C3216X7R474KEP | 1V, 1kHz            | 470         | nF         | ±10%                | 1.25        | ±0.15         | ±0.20     | 5.0%            | Embossed, 3Kpcs  | (I)        |
|                  | C3216X7R105KEPS  | C3216X7R105KEP | 1V, 1kHz            | 1.0         | uF         | ±10%                | 1.25        | ±0.15         | ±0.20     | 5.0%            |                  | (I)        |
|                  | C3216X7R225KEPS  | C3216X7R225KEP | 1V, 1kHz            | 2.2         | uF         | ±10%                | 1.60        | ±0.30         | ±0.30     | 10.0%           | (I)              |            |
|                  | C3216X7R475□EPS  | C3216X7R475□EP | 1V, 1kHz            | 4.7         | uF         | ±10%, ±20%          | 1.60        | ±0.30         | ±0.30     | 10.0%           | (I)              |            |
| C3216X7R106□EPS  | C3216X7R106□EP   | 1V, 1kHz       | 10                  | uF          | ±10%, ±20% | 1.60                | ±0.30       | ±0.30         | 10.0%     | (II)*           |                  |            |
| 10V              | C3216X7R225KDPS  | C3216X7R225KDP | 1V, 1kHz            | 2.2         | uF         | ±10%                | 1.60        | ±0.30         | ±0.30     | 10.0%           | Embossed, 2Kpcs  | (I)        |
|                  | C3216X7R106□DPS  | C3216X7R106□DP | 1V, 1kHz            | 10          | uF         | ±10%, ±20%          | 1.60        | ±0.30         | ±0.30     | 10.0%           |                  | (II)       |
|                  | C3216X7R226□DPS  | C3216X7R226□DP | 0.5V, 120Hz         | 22          | uF         | ±10%, ±20%          | 1.60        | ±0.30         | ±0.30     | 10.0%           |                  | (II)       |
| 6.3V             | C3216X7R226KCPS  | C3216X7R226KCP | 0.5V, 120Hz         | 22          | uF         | ±10%                | 1.60        | ±0.30         | ±0.30     | 10.0%           | (II)             |            |

● C3225X7R Series (EIA1210)

| RV  | DARFON P/N      | DARFON P/N 2   | Measuring Condition | Capacitance |      | Available Tolerance | Thick. (mm) | Tolerance(mm) |        | DF (max.) | Standard Packing | Test Spec. |
|-----|-----------------|----------------|---------------------|-------------|------|---------------------|-------------|---------------|--------|-----------|------------------|------------|
|     |                 |                |                     | Value       | Unit |                     |             | LW            | Thick. |           |                  |            |
| 50V | C3225X7R225MGPS | C3225X7R225MGP | 1V, 1kHz            | 2.2         | uF   | ±20%                | 2.50        | ±0.3/±0.2     | ±0.20  | 5.0%      | Embossed, 1Kpcs  | (II)       |
|     | C3225X7R475KGPS | C3225X7R475KGP | 1V, 1kHz            | 4.7         | uF   | ±10%                | 2.50        | ±0.3/±0.2     | ±0.20  | 10.0%     |                  | (II)       |
|     | C3225X7R106KGWS | C3225X7R106KGW | 1V, 1kHz            | 10          | uF   | ±10%                | 2.00        | ±0.3/±0.2     | ±0.20  | 15.0%     |                  | (II)       |
|     | C3225X7R106□GPS | C3225X7R106□GP | 1V, 1kHz            | 10          | uF   | ±10%, ±20%          | 2.50        | ±0.30         | ±0.30  | 10.0%     |                  | (II)       |
| 35V | C3225X7R106KNPS | C3225X7R106KNP | 1V, 1kHz            | 10          | uF   | ±10%                | 2.50        | ±0.30         | ±0.30  | 10.0%     | Embossed, 1Kpcs  | (II)       |
| 25V | C3225X7R475KFPS | C3225X7R475KFP | 1V, 1kHz            | 4.7         | uF   | ±10%                | 2.00        | ±0.3/±0.2     | ±0.20  | 10.0%     | Embossed, 2Kpcs  | (I)        |
|     | C3225X7R106KFPS | C3225X7R106KFP | 1V, 1kHz            | 10          | uF   | ±10%                | 2.00        | ±0.3/±0.2     | ±0.30  | 10.0%     |                  | (II)       |
|     | C3225X7R226□FPS | C3225X7R226□FP | 0.5V, 120Hz         | 22          | uF   | ±10%, ±20%          | 2.50        | ±0.3/±0.2     | ±0.20  | 10.0%     | Embossed, 1Kpcs  | (II)       |
| 16V | C3225X7R475KEPS | C3225X7R475KEP | 1V, 1kHz            | 4.7         | uF   | ±10%                | 2.50        | ±0.3/±0.2     | ±0.20  | 5.0%      | Embossed, 1Kpcs  | (II)       |
|     | C3225X7R106KEPS | C3225X7R106KEP | 1V, 1kHz            | 10          | uF   | ±10%                | 2.00        | ±0.3/±0.2     | ±0.20  | 10.0%     | Embossed, 2Kpcs  | (I)        |
|     | C3225X7R226□EPS | C3225X7R226□EP | 0.5V, 120Hz         | 22          | uF   | ±10%, ±20%          | 2.50        | ±0.3/±0.2     | ±0.30  | 10.0%     | Embossed, 1Kpcs  | (II)       |
| 10V | C3225X7R226KDPS | C3225X7R226KDP | 0.5V, 120Hz         | 22          | uF   | ±10%                | 2.50        | ±0.3/±0.2     | ±0.20  | 10.0%     | Embossed, 1Kpcs  | (II)       |
|     | C3225X7R476□DPS | C3225X7R476□DP | 0.5V, 120Hz         | 47          | uF   | ±10%, ±20%          | 2.50        | ±0.3/±0.2     | ±0.20  | 10.0%     |                  | (II)       |

□ Tolerance Code: J=±5%, K=±10%, M=±20%; Special tolerance on the request.

(II)\* High temperature load life test are applicable in rated voltage \*100%

- X7S Series
- C0603X7S Series (EIA0201)

| RV   | DARFON P/N      | DARFON P/N 2   | Measuring Condition | Capacitance |      | Available Tolerance | Thick. (mm) | Tolerance(mm) |        | DF (max.) | Standard Packing | Test Spec. |
|------|-----------------|----------------|---------------------|-------------|------|---------------------|-------------|---------------|--------|-----------|------------------|------------|
|      |                 |                |                     | Value       | Unit |                     |             | L/W           | Thick. |           |                  |            |
| 16V  | C0603X7S104□ETS | C0603X7S104□ET | 1V, 1kHz            | 100         | nF   | ±10%,±20%           | 0.30        | ± 0.03        | ±0.03  | 10.0%     | Paper, 15Kpcs    | (II)*      |
| 10V  | C0603X7S104KDTS | C0603X7S104KDT | 1V, 1kHz            | 100         | nF   | ±10%                | 0.30        | ± 0.03        | ±0.03  | 10.0%     | Paper, 15Kpcs    | (II)       |
| 6.3V | C0603X7S104KCTS | C0603X7S104KCT | 1V, 1kHz            | 100         | nF   | ±10%                | 0.30        | ± 0.03        | ±0.03  | 10.0%     | Paper, 15Kpcs    | (II)       |

- C1005X7S Series (EIA0402)

| RV   | DARFON P/N      | DARFON P/N 2   | Measuring Condition | Capacitance |      | Available Tolerance | Thick. (mm) | Tolerance(mm) |        | DF (max.) | Standard Packing | Test Spec. |
|------|-----------------|----------------|---------------------|-------------|------|---------------------|-------------|---------------|--------|-----------|------------------|------------|
|      |                 |                |                     | Value       | Unit |                     |             | L/W           | Thick. |           |                  |            |
| 10V  | C1005X7S105KDTS | C1005X7S105KDT | 1V, 1kHz            | 1.0         | uF   | ±10%                | 0.50        | ± 0.10        | ±0.10  | 10.0%     | Paper, 10Kpcs    | (II)       |
|      | C1005X7S225KDTS | C1005X7S225KDT | 1V, 1kHz            | 2.2         | uF   | ±10%                | 0.50        | ± 0.20        | ±0.20  | 10.0%     |                  | (II)       |
| 6.3V | C1005X7S225KCTS | C1005X7S225KCT | 1V, 1kHz            | 2.2         | uF   | ±10%                | 0.50        | ± 0.20        | ±0.20  | 10.0%     |                  | (II)       |

- C1608X7S Series (EIA0603)

| RV  | DARFON P/N      | DARFON P/N 2   | Measuring Condition | Capacitance |      | Available Tolerance | Thick. (mm) | Tolerance(mm) |        | DF (max.) | Standard Packing | Test Spec. |
|-----|-----------------|----------------|---------------------|-------------|------|---------------------|-------------|---------------|--------|-----------|------------------|------------|
|     |                 |                |                     | Value       | Unit |                     |             | L/W           | Thick. |           |                  |            |
| 16V | C1608X7S225KETS | C1608X7S225KET | 1V, 1kHz            | 2.2         | uF   | ±10%                | 0.80        | ± 0.20        | ±0.20  | 10.0%     | Paper, 4Kpcs     | (II)       |
|     | C1608X7S475KETS | C1608X7S475KET | 1V, 1kHz            | 4.7         | uF   | ±10%                | 0.80        | ± 0.20        | ±0.20  | 10.0%     |                  | (II)       |
| 10V | C1608X7S475KDTS | C1608X7S475KDT | 1V, 1kHz            | 4.7         | uF   | ±10%                | 0.80        | ± 0.15        | ±0.15  | 10.0%     |                  | (II)       |

- C2012X7S Series (EIA0805)

| RV  | DARFON P/N      | DARFON P/N 2   | Measuring Condition | Capacitance |      | Available Tolerance | Thick. (mm) | Tolerance(mm) |        | DF (max.) | Standard Packing | Test Spec. |
|-----|-----------------|----------------|---------------------|-------------|------|---------------------|-------------|---------------|--------|-----------|------------------|------------|
|     |                 |                |                     | Value       | Unit |                     |             | L/W           | Thick. |           |                  |            |
| 50V | C2012X7S475KGPS | C2012X7S475KGP | 1V, 1kHz            | 4.7         | uF   | ±10%                | 1.25        | ± 0.20        | ±0.20  | 10.0%     | Embossed, 3Kpcs  | (II)       |
| 25V | C2012X7S225KFPS | C2012X7S225KFP | 1V, 1kHz            | 2.2         | uF   | ±10%                | 1.25        | ± 0.15        | ±0.15  | 10.0%     |                  | (II)       |
|     | C2012X7S106□FPS | C2012X7S106□FP | 1V, 1kHz            | 10          | uF   | ±10%,±20%           | 1.25        | ± 0.20        | ±0.20  | 10.0%     |                  | (II)*      |

- C3225X7S Series (EIA1210)

| RV   | DARFON P/N      | DARFON P/N 2   | Measuring Condition | Capacitance |      | Available Tolerance | Thick. (mm) | Tolerance(mm) |        | DF (max.) | Standard Packing | Test Spec. |
|------|-----------------|----------------|---------------------|-------------|------|---------------------|-------------|---------------|--------|-----------|------------------|------------|
|      |                 |                |                     | Value       | Unit |                     |             | L/W           | Thick. |           |                  |            |
| 6.3V | C3225X7S107MCPS | C3225X7S107MCP | 0.5V, 100Hz         | 100         | uF   | ±20%                | 2.50        | ± 0.30        | ±0.30  | 10.0%     | Embossed, 1Kpcs  | (II)*      |

□ Tolerance Code: K=±10%, M=±20%; Special tolerance on the request.

(II)\* High temperature load life test are applicable in rated voltage \*100%

■ X7T Series

● C1608X7T Series (EIA0603)

| RV   | DARFON P/N      | DARFON P/N 2   | Measuring Condition | Capacitance |      | Available Tolerance | Thick. (mm) | Tolerance(mm) |        | DF (max.) | Standard Packing | Test Spec. |
|------|-----------------|----------------|---------------------|-------------|------|---------------------|-------------|---------------|--------|-----------|------------------|------------|
|      |                 |                |                     | Value       | Unit |                     |             | L/W           | Thick. |           |                  |            |
| 6.3V | C1608X7T106MCTS | C1608X7T106MCT | 1V , 1kHz           | 10          | uF   | ±20%                | 0.80        | ± 0.20        | ±0.20  | 10.0%     | Paper, 4Kpcs     | (II)       |

● C2012X7T Series (EIA0805)

| RV   | DARFON P/N      | DARFON P/N 2   | Measuring Condition | Capacitance |      | Available Tolerance | Thick. (mm) | Tolerance(mm) |        | DF (max.) | Standard Packing | Test Spec. |
|------|-----------------|----------------|---------------------|-------------|------|---------------------|-------------|---------------|--------|-----------|------------------|------------|
|      |                 |                |                     | Value       | Unit |                     |             | L/W           | Thick. |           |                  |            |
| 10V  | C2012X7T226MDPS | C2012X7T226MDP | 0.5V , 120Hz        | 22          | uF   | ±20%                | 1.25        | ± 0.20        | ±0.20  | 10.0%     | Embossed, 3Kpcs  | (II)*      |
| 6.3V | C2012X7T226MCPS | C2012X7T226MCP | 0.5V , 120Hz        | 22          | uF   | ±20%                | 1.25        | ± 0.20        | ±0.20  | 10.0%     | Embossed, 3Kpcs  | (II)       |

□ Tolerance Code: K=±10%, M=±20%; Special tolerance on the request.

(II)\* High temperature load life test are applicable in rated voltage \*100%

- X7U Series
- C3216X7U Series (EIA1206)

| RV   | DARFON P/N      | DARFON P/N 2   | Measuring Condition | Capacitance |      | Available Tolerance | Thick. (mm) | Tolerance(mm) |        | DF (max.) | Standard Packing | Test Spec. |
|------|-----------------|----------------|---------------------|-------------|------|---------------------|-------------|---------------|--------|-----------|------------------|------------|
|      |                 |                |                     | Value       | Unit |                     |             | L/W           | Thick. |           |                  |            |
| 6.3V | C3216X7U476MCPS | C3216X7U476MCP | 0.5V , 120Hz        | 47          | uF   | ±20%                | 1.60        | ± 0.30        | ±0.30  | 15.0%     | Embossed, 2Kpcs  | (II)*      |
| 4V   | C3216X7U107MBPS | C3216X7U107MBP | 0.5V , 120Hz        | 100         | uF   | ±20%                | 1.60        | ± 0.30        | ±0.30  | 15.0%     | Embossed, 2Kpcs  | (II)*      |

□ Tolerance Code: K=±10%, M=±20%; Special tolerance on the request.

(II)\* High temperature load life test are applicable in rated voltage \*100%



■ Y5V Series

● C1005Y5V Series (EIA0402)

| RV   | DARFON P/N      | DARFON P/N 2   | Measuring Condition | Capacitance |      | Available Tolerance | Thick. (mm) | Tolerance(mm) |        | DF (max.) | Standard Packing | Test Spec. |
|------|-----------------|----------------|---------------------|-------------|------|---------------------|-------------|---------------|--------|-----------|------------------|------------|
|      |                 |                |                     | Value       | Unit |                     |             | L/W           | Thick. |           |                  |            |
| 50V  | C1005Y5V103ZGTS | C1005Y5V103ZGT | 1V, 1kHz            | 10          | nF   | +80%/-20%           | 0.50        | ±0.05         | ±0.05  | 7.0%      | Paper, 10Kpcs    | (I)        |
|      | C1005Y5V223ZGTS | C1005Y5V223ZGT | 1V, 1kHz            | 22          | nF   | +80%/-20%           | 0.50        | ±0.05         | ±0.05  | 9.0%      |                  | (II)       |
| 25V  | C1005Y5V103ZFTS | C1005Y5V103ZFT | 1V, 1kHz            | 10          | nF   | +80%/-20%           | 0.50        | ±0.05         | ±0.05  | 9.0%      | Paper, 10Kpcs    | (I)        |
|      | C1005Y5V223ZFTS | C1005Y5V223ZFT | 1V, 1kHz            | 22          | nF   | +80%/-20%           | 0.50        | ±0.05         | ±0.05  | 9.0%      |                  | (II)       |
|      | C1005Y5V473ZFTS | C1005Y5V473ZFT | 1V, 1kHz            | 47          | nF   | +80%/-20%           | 0.50        | ±0.05         | ±0.05  | 9.0%      |                  | (III)      |
|      | C1005Y5V104JFTS | C1005Y5V104JFT | 1V, 1kHz            | 100         | nF   | ±20%, +80%/-20%     | 0.50        | ±0.05         | ±0.05  | 9.0%      |                  | (IV)       |
| 16V  | C1005Y5V473ZETS | C1005Y5V473ZET | 1V, 1kHz            | 47          | nF   | +80%/-20%           | 0.50        | ±0.05         | ±0.05  | 9.0%      | Paper, 10Kpcs    | (I)        |
|      | C1005Y5V224ZETS | C1005Y5V224ZET | 1V, 1kHz            | 220         | nF   | +80%/-20%           | 0.50        | ±0.05         | ±0.05  | 9.0%      |                  | (II)       |
|      | C1005Y5V474ZETS | C1005Y5V474ZET | 1V, 1kHz            | 470         | nF   | +80%/-20%           | 0.50        | ±0.05         | ±0.05  | 12.5%     |                  | (III)      |
| 10V  | C1005Y5V224ZDTS | C1005Y5V224ZDT | 1V, 1kHz            | 220         | nF   | +80%/-20%           | 0.50        | ±0.05         | ±0.05  | 12.5%     | Paper, 10Kpcs    | (I)        |
|      | C1005Y5V334ZDTS | C1005Y5V334ZDT | 1V, 1kHz            | 330         | nF   | +80%/-20%           | 0.50        | ±0.05         | ±0.05  | 16.0%     |                  | (II)       |
|      | C1005Y5V474ZDTS | C1005Y5V474ZDT | 1V, 1kHz            | 470         | nF   | +80%/-20%           | 0.50        | ±0.05         | ±0.05  | 16.0%     |                  | (III)      |
|      | C1005Y5V105ZDTS | C1005Y5V105ZDT | 1V, 1kHz            | 1.0         | uF   | +80%/-20%           | 0.50        | ±0.05         | ±0.05  | 16.0%     |                  | (IV)       |
| 6.3V | C1005Y5V224ZCTS | C1005Y5V224ZCT | 1V, 1kHz            | 220         | nF   | +80%/-20%           | 0.50        | ±0.05         | ±0.05  | 12.5%     | Paper, 10Kpcs    | (I)        |
|      | C1005Y5V334ZCTS | C1005Y5V334ZCT | 1V, 1kHz            | 330         | nF   | +80%/-20%           | 0.50        | ±0.05         | ±0.05  | 16.0%     |                  | (II)       |
|      | C1005Y5V474ZCTS | C1005Y5V474ZCT | 1V, 1kHz            | 470         | nF   | +80%/-20%           | 0.50        | ±0.05         | ±0.05  | 16.0%     |                  | (III)      |
|      | C1005Y5V105ZCTS | C1005Y5V105ZCT | 1V, 1kHz            | 1.0         | uF   | +80%/-20%           | 0.50        | ±0.05         | ±0.05  | 16.0%     |                  | (IV)       |

● C1608Y5V Series (EIA0603)

| RV              | DARFON P/N      | DARFON P/N 2   | Measuring Condition | Capacitance |           | Available Tolerance | Thick. (mm) | Tolerance(mm) |        | DF (max.) | Standard Packing | Test Spec. |
|-----------------|-----------------|----------------|---------------------|-------------|-----------|---------------------|-------------|---------------|--------|-----------|------------------|------------|
|                 |                 |                |                     | Value       | Unit      |                     |             | L/W           | Thick. |           |                  |            |
| 50V             | C1608Y5V103ZGTS | C1608Y5V103ZGT | 1V, 1kHz            | 10          | nF        | +80%/-20%           | 0.80        | ±0.10         | ±0.10  | 5.0%      | Paper, 4Kpcs     | (I)        |
|                 | C1608Y5V123ZGTS | C1608Y5V123ZGT | 1V, 1kHz            | 12          | nF        | +80%/-20%           | 0.80        | ±0.10         | ±0.10  | 5.0%      |                  | (II)       |
|                 | C1608Y5V153ZGTS | C1608Y5V153ZGT | 1V, 1kHz            | 15          | nF        | +80%/-20%           | 0.80        | ±0.10         | ±0.10  | 5.0%      |                  | (III)      |
|                 | C1608Y5V183ZGTS | C1608Y5V183ZGT | 1V, 1kHz            | 18          | nF        | +80%/-20%           | 0.80        | ±0.10         | ±0.10  | 5.0%      |                  | (IV)       |
|                 | C1608Y5V223ZGTS | C1608Y5V223ZGT | 1V, 1kHz            | 22          | nF        | +80%/-20%           | 0.80        | ±0.10         | ±0.10  | 5.0%      |                  | (V)        |
|                 | C1608Y5V273ZGTS | C1608Y5V273ZGT | 1V, 1kHz            | 27          | nF        | +80%/-20%           | 0.80        | ±0.10         | ±0.10  | 5.0%      |                  | (VI)       |
|                 | C1608Y5V333ZGTS | C1608Y5V333ZGT | 1V, 1kHz            | 33          | nF        | +80%/-20%           | 0.80        | ±0.10         | ±0.10  | 5.0%      |                  | (VII)      |
|                 | C1608Y5V393ZGTS | C1608Y5V393ZGT | 1V, 1kHz            | 39          | nF        | +80%/-20%           | 0.80        | ±0.10         | ±0.10  | 5.0%      |                  | (VIII)     |
|                 | C1608Y5V473ZGTS | C1608Y5V473ZGT | 1V, 1kHz            | 47          | nF        | +80%/-20%           | 0.80        | ±0.10         | ±0.10  | 5.0%      |                  | (IX)       |
|                 | C1608Y5V563ZGTS | C1608Y5V563ZGT | 1V, 1kHz            | 56          | nF        | +80%/-20%           | 0.80        | ±0.10         | ±0.10  | 5.0%      |                  | (X)        |
|                 | C1608Y5V683ZGTS | C1608Y5V683ZGT | 1V, 1kHz            | 68          | nF        | +80%/-20%           | 0.80        | ±0.10         | ±0.10  | 5.0%      |                  | (XI)       |
|                 | C1608Y5V823ZGTS | C1608Y5V823ZGT | 1V, 1kHz            | 82          | nF        | +80%/-20%           | 0.80        | ±0.10         | ±0.10  | 5.0%      |                  | (XII)      |
|                 | C1608Y5V104ZGTS | C1608Y5V104ZGT | 1V, 1kHz            | 100         | nF        | +80%/-20%           | 0.80        | ±0.10         | ±0.10  | 7.0%      |                  | (XIII)     |
|                 | C1608Y5V224ZGTS | C1608Y5V224ZGT | 1V, 1kHz            | 220         | nF        | +80%/-20%           | 0.80        | ±0.10         | ±0.10  | 9.0%      |                  | (XIV)      |
| C1608Y5V474ZGTS | C1608Y5V474ZGT  | 1V, 1kHz       | 470                 | nF          | +80%/-20% | 0.80                | ±0.15       | ±0.15         | 9.0%   | (I)       |                  |            |
| 25V             | C1608Y5V103ZFTS | C1608Y5V103ZFT | 1V, 1kHz            | 10          | nF        | +80%/-20%           | 0.80        | ±0.10         | ±0.10  | 5.0%      | Paper, 4Kpcs     | (I)        |
|                 | C1608Y5V123ZFTS | C1608Y5V123ZFT | 1V, 1kHz            | 12          | nF        | +80%/-20%           | 0.80        | ±0.10         | ±0.10  | 5.0%      |                  | (II)       |
|                 | C1608Y5V153ZFTS | C1608Y5V153ZFT | 1V, 1kHz            | 15          | nF        | +80%/-20%           | 0.80        | ±0.10         | ±0.10  | 5.0%      |                  | (III)      |
|                 | C1608Y5V183ZFTS | C1608Y5V183ZFT | 1V, 1kHz            | 18          | nF        | +80%/-20%           | 0.80        | ±0.10         | ±0.10  | 5.0%      |                  | (IV)       |
|                 | C1608Y5V223ZFTS | C1608Y5V223ZFT | 1V, 1kHz            | 22          | nF        | +80%/-20%           | 0.80        | ±0.10         | ±0.10  | 5.0%      |                  | (V)        |
|                 | C1608Y5V273ZFTS | C1608Y5V273ZFT | 1V, 1kHz            | 27          | nF        | +80%/-20%           | 0.80        | ±0.10         | ±0.10  | 5.0%      |                  | (VI)       |
|                 | C1608Y5V333ZFTS | C1608Y5V333ZFT | 1V, 1kHz            | 33          | nF        | +80%/-20%           | 0.80        | ±0.10         | ±0.10  | 5.0%      |                  | (VII)      |
|                 | C1608Y5V393ZFTS | C1608Y5V393ZFT | 1V, 1kHz            | 39          | nF        | +80%/-20%           | 0.80        | ±0.10         | ±0.10  | 5.0%      |                  | (VIII)     |
|                 | C1608Y5V473ZFTS | C1608Y5V473ZFT | 1V, 1kHz            | 47          | nF        | +80%/-20%           | 0.80        | ±0.10         | ±0.10  | 5.0%      |                  | (IX)       |
|                 | C1608Y5V563ZFTS | C1608Y5V563ZFT | 1V, 1kHz            | 56          | nF        | +80%/-20%           | 0.80        | ±0.10         | ±0.10  | 5.0%      |                  | (X)        |
|                 | C1608Y5V683ZFTS | C1608Y5V683ZFT | 1V, 1kHz            | 68          | nF        | +80%/-20%           | 0.80        | ±0.10         | ±0.10  | 5.0%      |                  | (XI)       |
|                 | C1608Y5V823ZFTS | C1608Y5V823ZFT | 1V, 1kHz            | 82          | nF        | +80%/-20%           | 0.80        | ±0.10         | ±0.10  | 5.0%      |                  | (XII)      |
|                 | C1608Y5V104ZFTS | C1608Y5V104ZFT | 1V, 1kHz            | 100         | nF        | +80%/-20%           | 0.80        | ±0.10         | ±0.10  | 7.0%      |                  | (XIII)     |
|                 | C1608Y5V224ZFTS | C1608Y5V224ZFT | 1V, 1kHz            | 220         | nF        | +80%/-20%           | 0.80        | ±0.10         | ±0.10  | 9.0%      |                  | (XIV)      |
| C1608Y5V334ZFTS | C1608Y5V334ZFT  | 1V, 1kHz       | 330                 | nF          | +80%/-20% | 0.80                | ±0.10       | ±0.10         | 9.0%   | (I)       |                  |            |
| C1608Y5V684ZFTS | C1608Y5V684ZFT  | 1V, 1kHz       | 680                 | nF          | +80%/-20% | 0.80                | ±0.15       | ±0.15         | 9.0%   | (II)      |                  |            |
| C1608Y5V105ZFTS | C1608Y5V105ZFT  | 1V, 1kHz       | 1.0                 | uF          | +80%/-20% | 0.80                | ±0.15       | ±0.15         | 10.0%  | (III)     |                  |            |
| 16V             | C1608Y5V103ZETS | C1608Y5V103ZET | 1V, 1kHz            | 10          | nF        | +80%/-20%           | 0.80        | ±0.10         | ±0.10  | 7.0%      | Paper, 4Kpcs     | (I)        |
|                 | C1608Y5V123ZETS | C1608Y5V123ZET | 1V, 1kHz            | 12          | nF        | +80%/-20%           | 0.80        | ±0.10         | ±0.10  | 7.0%      |                  | (II)       |
|                 | C1608Y5V153ZETS | C1608Y5V153ZET | 1V, 1kHz            | 15          | nF        | +80%/-20%           | 0.80        | ±0.10         | ±0.10  | 7.0%      |                  | (III)      |
|                 | C1608Y5V183ZETS | C1608Y5V183ZET | 1V, 1kHz            | 18          | nF        | +80%/-20%           | 0.80        | ±0.10         | ±0.10  | 7.0%      |                  | (IV)       |
|                 | C1608Y5V223ZETS | C1608Y5V223ZET | 1V, 1kHz            | 22          | nF        | +80%/-20%           | 0.80        | ±0.10         | ±0.10  | 7.0%      |                  | (V)        |
|                 | C1608Y5V273ZETS | C1608Y5V273ZET | 1V, 1kHz            | 27          | nF        | +80%/-20%           | 0.80        | ±0.10         | ±0.10  | 7.0%      |                  | (VI)       |
|                 | C1608Y5V333ZETS | C1608Y5V333ZET | 1V, 1kHz            | 33          | nF        | +80%/-20%           | 0.80        | ±0.10         | ±0.10  | 7.0%      |                  | (VII)      |
|                 | C1608Y5V393ZETS | C1608Y5V393ZET | 1V, 1kHz            | 39          | nF        | +80%/-20%           | 0.80        | ±0.10         | ±0.10  | 7.0%      |                  | (VIII)     |
|                 | C1608Y5V473ZETS | C1608Y5V473ZET | 1V, 1kHz            | 47          | nF        | +80%/-20%           | 0.80        | ±0.10         | ±0.10  | 7.0%      |                  | (IX)       |
|                 | C1608Y5V563ZETS | C1608Y5V563ZET | 1V, 1kHz            | 56          | nF        | +80%/-20%           | 0.80        | ±0.10         | ±0.10  | 7.0%      |                  | (X)        |
|                 | C1608Y5V683ZETS | C1608Y5V683ZET | 1V, 1kHz            | 68          | nF        | +80%/-20%           | 0.80        | ±0.10         | ±0.10  | 7.0%      |                  | (XI)       |
|                 | C1608Y5V823ZETS | C1608Y5V823ZET | 1V, 1kHz            | 82          | nF        | +80%/-20%           | 0.80        | ±0.10         | ±0.10  | 7.0%      |                  | (XII)      |
|                 | C1608Y5V104ZETS | C1608Y5V104ZET | 1V, 1kHz            | 100         | nF        | +80%/-20%           | 0.80        | ±0.10         | ±0.10  | 7.0%      |                  | (XIII)     |
|                 | C1608Y5V224ZETS | C1608Y5V224ZET | 1V, 1kHz            | 220         | nF        | +80%/-20%           | 0.80        | ±0.10         | ±0.10  | 9.0%      |                  | (XIV)      |
| C1608Y5V334ZETS | C1608Y5V334ZET  | 1V, 1kHz       | 330                 | nF          | +80%/-20% | 0.80                | ±0.10       | ±0.10         | 12.5%  | (I)       |                  |            |
| C1608Y5V474ZETS | C1608Y5V474ZET  | 1V, 1kHz       | 470                 | nF          | +80%/-20% | 0.80                | ±0.10       | ±0.10         | 12.5%  | (II)      |                  |            |
| C1608Y5V684ZETS | C1608Y5V684ZET  | 1V, 1kHz       | 680                 | nF          | +80%/-20% | 0.80                | ±0.10       | ±0.10         | 12.5%  | (III)     |                  |            |
| C1608Y5V824ZETS | C1608Y5V824ZET  | 1V, 1kHz       | 820                 | nF          | +80%/-20% | 0.80                | +0.15/-0.10 | +0.15/-0.10   | 12.5%  | (IV)      |                  |            |
| C1608Y5V105ZETS | C1608Y5V105ZET  | 1V, 1kHz       | 1.0                 | uF          | +80%/-20% | 0.80                | +0.15/-0.10 | +0.15/-0.10   | 12.5%  | (V)       |                  |            |
| C1608Y5V225ZETS | C1608Y5V225ZET  | 1V, 1kHz       | 2.2                 | uF          | +80%/-20% | 0.80                | +0.15/-0.10 | +0.15/-0.10   | 12.5%  | (VI)      |                  |            |

□ Tolerance Code: M=±20%; Special tolerance on the request.



| RV   | DARFON P/N      | DARFON P/N 2   | Measuring Condition | Capacitance |      | Available Tolerance | Thick. (mm) | Tolerance(mm) |             | DF (max.) | Standard Packing | Test Spec. |
|------|-----------------|----------------|---------------------|-------------|------|---------------------|-------------|---------------|-------------|-----------|------------------|------------|
|      |                 |                |                     | Value       | Unit |                     |             | L/W           | Thick.      |           |                  |            |
| 10V  | C1608Y5V104ZDTS | C1608Y5V104ZDT | 1V, 1kHz            | 100         | nF   | +80%/-20%           | 0.80        | ±0.10         | ±0.10       | 12.5%     | Paper, 4Kpcs     | (I)        |
|      | C1608Y5V224ZDTS | C1608Y5V224ZDT | 1V, 1kHz            | 220         | nF   | +80%/-20%           | 0.80        | ±0.10         | ±0.10       | 12.5%     |                  | (II)       |
|      | C1608Y5V334ZDTS | C1608Y5V334ZDT | 1V, 1kHz            | 330         | nF   | +80%/-20%           | 0.80        | ±0.10         | ±0.10       | 12.5%     |                  | (II)       |
|      | C1608Y5V474ZDTS | C1608Y5V474ZDT | 1V, 1kHz            | 470         | nF   | +80%/-20%           | 0.80        | ±0.10         | ±0.10       | 12.5%     |                  | (II)       |
|      | C1608Y5V105ZDTS | C1608Y5V105ZDT | 1V, 1kHz            | 1.0         | uF   | +80%/-20%           | 0.80        | +0.15/-0.10   | +0.15/-0.10 | 12.5%     |                  | (II)       |
|      | C1608Y5V225ZDTS | C1608Y5V225ZDT | 1V, 1kHz            | 2.2         | uF   | +80%/-20%           | 0.80        | +0.15/-0.10   | +0.15/-0.10 | 12.5%     |                  | (II)       |
| 6.3V | C1608Y5V475ZDTS | C1608Y5V475ZDT | 1V, 1kHz            | 4.7         | uF   | +80%/-20%           | 0.80        | +0.15/-0.10   | +0.15/-0.10 | 12.5%     | (II)*            |            |
|      | C1608Y5V104ZCTS | C1608Y5V104ZCT | 1V, 1kHz            | 100         | nF   | +80%/-20%           | 0.80        | ±0.10         | ±0.10       | 12.5%     | (I)              |            |
|      | C1608Y5V224ZCTS | C1608Y5V224ZCT | 1V, 1kHz            | 220         | nF   | +80%/-20%           | 0.80        | ±0.10         | ±0.10       | 12.5%     | (I)              |            |
|      | C1608Y5V334ZCTS | C1608Y5V334ZCT | 1V, 1kHz            | 330         | nF   | +80%/-20%           | 0.80        | ±0.10         | ±0.10       | 12.5%     | (I)              |            |
|      | C1608Y5V474ZCTS | C1608Y5V474ZCT | 1V, 1kHz            | 470         | nF   | +80%/-20%           | 0.80        | ±0.10         | ±0.10       | 12.5%     | (I)              |            |
|      | C1608Y5V105ZCTS | C1608Y5V105ZCT | 1V, 1kHz            | 1.0         | uF   | +80%/-20%           | 0.80        | +0.15/-0.10   | +0.15/-0.10 | 12.5%     | (I)              |            |
|      | C1608Y5V225ZCTS | C1608Y5V225ZCT | 1V, 1kHz            | 2.2         | uF   | +80%/-20%           | 0.80        | +0.15/-0.10   | +0.15/-0.10 | 12.5%     | (I)              |            |
|      | C1608Y5V475ZCTS | C1608Y5V475ZCT | 1V, 1kHz            | 4.7         | uF   | +80%/-20%           | 0.80        | +0.15/-0.10   | +0.15/-0.10 | 12.5%     | (II)             |            |

● C2012Y5V Series (EIA0805)

| RV  | DARFON P/N      | DARFON P/N 2   | Measuring Condition | Capacitance |      | Available Tolerance | Thick. (mm) | Tolerance(mm) |        | DF (max.) | Standard Packing | Test Spec.      |
|-----|-----------------|----------------|---------------------|-------------|------|---------------------|-------------|---------------|--------|-----------|------------------|-----------------|
|     |                 |                |                     | Value       | Unit |                     |             | L/W           | Thick. |           |                  |                 |
| 50V | C2012Y5V104ZGTS | C2012Y5V104ZGT | 1V, 1kHz            | 100         | nF   | +80%/-20%           | 0.60        | ±0.15/±0.10   | ±0.10  | 5.0%      | Paper, 4Kpcs     | (I)             |
|     | C2012Y5V224ZGTS | C2012Y5V224ZGT | 1V, 1kHz            | 220         | nF   | +80%/-20%           | 0.60        | ±0.15/±0.10   | ±0.10  | 5.0%      |                  | (I)             |
|     | C2012Y5V334ZGTS | C2012Y5V334ZGT | 1V, 1kHz            | 330         | nF   | +80%/-20%           | 0.80        | ±0.15/±0.10   | ±0.10  | 5.0%      |                  | (I)             |
|     | C2012Y5V474ZGTS | C2012Y5V474ZGT | 1V, 1kHz            | 470         | nF   | +80%/-20%           | 0.80        | ±0.15/±0.10   | ±0.10  | 7.0%      |                  | (I)             |
|     | C2012Y5V105ZGTS | C2012Y5V105ZGP | 1V, 1kHz            | 1.0         | uF   | +80%/-20%           | 1.25        | ±0.20         | ±0.20  | 9.0%      |                  | Embossed, 3Kpcs |
| 25V | C2012Y5V104ZFTS | C2012Y5V104ZFT | 1V, 1kHz            | 100         | nF   | +80%/-20%           | 0.60        | ±0.15/±0.10   | ±0.10  | 5.0%      | Paper, 4Kpcs     | (I)             |
|     | C2012Y5V224ZFTS | C2012Y5V224ZFT | 1V, 1kHz            | 220         | nF   | +80%/-20%           | 0.60        | ±0.15/±0.10   | ±0.10  | 5.0%      |                  | (I)             |
|     | C2012Y5V474ZFTS | C2012Y5V474ZFT | 1V, 1kHz            | 470         | nF   | +80%/-20%           | 0.80        | ±0.15/±0.10   | ±0.10  | 7.0%      |                  | (I)             |
|     | C2012Y5V105ZFTS | C2012Y5V105ZFT | 1V, 1kHz            | 1.0         | uF   | +80%/-20%           | 0.85        | ±0.20         | ±0.15  | 9.0%      |                  | (II)            |
|     | C2012Y5V105ZFPS | C2012Y5V105ZFP | 1V, 1kHz            | 1.0         | uF   | +80%/-20%           | 1.25        | ±0.15/±0.10   | ±0.20  | 7.0%      |                  | (I)             |
|     | C2012Y5V225ZFPS | C2012Y5V225ZFP | 1V, 1kHz            | 2.2         | uF   | +80%/-20%           | 1.25        | ±0.20         | ±0.20  | 10.0%     |                  | Embossed, 3Kpcs |
| 16V | C2012Y5V104ZETS | C2012Y5V104ZET | 1V, 1kHz            | 100         | nF   | +80%/-20%           | 0.60        | ±0.15/±0.10   | ±0.10  | 5.0%      | Paper, 4Kpcs     | (I)             |
|     | C2012Y5V224ZETS | C2012Y5V224ZET | 1V, 1kHz            | 220         | nF   | +80%/-20%           | 0.60        | ±0.15/±0.10   | ±0.10  | 5.0%      |                  | (I)             |
|     | C2012Y5V474ZETS | C2012Y5V474ZET | 1V, 1kHz            | 470         | nF   | +80%/-20%           | 0.80        | ±0.15/±0.10   | ±0.10  | 7.0%      |                  | (I)             |
|     | C2012Y5V105ZETS | C2012Y5V105ZET | 1V, 1kHz            | 1.0         | uF   | +80%/-20%           | 0.85        | ±0.20         | ±0.15  | 9.0%      |                  | (I)             |
|     | C2012Y5V225ZETS | C2012Y5V225ZET | 1V, 1kHz            | 2.2         | uF   | +80%/-20%           | 0.85        | ±0.20         | ±0.15  | 12.5%     |                  | (I)             |
|     | C2012Y5V475ZEPS | C2012Y5V475ZEP | 1V, 1kHz            | 4.7         | uF   | +80%/-20%           | 1.25        | ±0.15/±0.10   | ±0.10  | 12.5%     |                  | (II)            |
| 10V | C2012Y5V106ZEPS | C2012Y5V106ZEP | 1V, 1kHz            | 10.0        | uF   | +80%/-20%           | 1.25        | ±0.20         | ±0.20  | 12.5%     | Embossed, 3Kpcs  | (II)*           |
|     | C2012Y5V475ZDPS | C2012Y5V475ZDP | 1V, 1kHz            | 4.7         | uF   | +80%/-20%           | 1.25        | ±0.15/±0.10   | ±0.10  | 12.5%     | Embossed, 3Kpcs  | (II)*           |
|     | C2012Y5V106ZDPS | C2012Y5V106ZDP | 1V, 1kHz            | 10          | uF   | +80%/-20%           | 1.25        | ±0.20         | ±0.20  | 12.5%     | Embossed, 3Kpcs  | (II)*           |

● C3216Y5V Series (EIA1206)

| RV  | DARFON P/N       | DARFON P/N 2   | Measuring Condition | Capacitance |      | Available Tolerance | Thick. (mm) | Tolerance(mm) |        | DF (max.) | Standard Packing | Test Spec.      |      |
|-----|------------------|----------------|---------------------|-------------|------|---------------------|-------------|---------------|--------|-----------|------------------|-----------------|------|
|     |                  |                |                     | Value       | Unit |                     |             | L/W           | Thick. |           |                  |                 |      |
| 50V | C3216Y5V105ZGSPS | C3216Y5V105ZGP | 1V, 1kHz            | 1.0         | uF   | +80%/-20%           | 0.95        | ±0.15/±0.20   | ±0.15  | 7.0%      | Embossed, 3Kpcs  | (I)             |      |
|     | C3216Y5V475ZGSPS | C3216Y5V475ZGP | 1V, 1kHz            | 4.7         | uF   | +80%/-20%           | 1.60        | ±0.30         | ±0.30  | 9.0%      | Embossed, 2Kpcs  | (I)             |      |
| 35V | C3216Y5V475ZNPS  | C3216Y5V475ZNP | 1V, 1kHz            | 4.7         | uF   | +80%/-20%           | 1.15        | ±0.20         | ±0.15  | 12.5%     | Embossed, 3Kpcs  | (II)*           |      |
| 25V | C3216Y5V225ZFPS  | C3216Y5V225ZFP | 1V, 1kHz            | 2.2         | uF   | +80%/-20%           | 0.95        | ±0.15/±0.20   | ±0.15  | 9.0%      | Embossed, 3Kpcs  | (I)             |      |
|     | C3216Y5V475ZFPS  | C3216Y5V475ZFP | 1V, 1kHz            | 4.7         | uF   | +80%/-20%           | 1.15        | ±0.20         | ±0.15  | 9.0%      |                  | (I)             |      |
|     | C3216Y5V106ZFPS  | C3216Y5V106ZFP | 1V, 1kHz            | 10          | uF   | +80%/-20%           | 1.60        | ±0.30         | ±0.30  | 12.5%     |                  | Embossed, 2Kpcs | (II) |
|     | C3216Y5V475ZETS  | C3216Y5V475ZET | 1V, 1kHz            | 4.7         | uF   | +80%/-20%           | 0.85        | ±0.30/±0.20   | ±0.10  | 12.5%     |                  | Paper, 4Kpcs    | (II) |
| 16V | C3216Y5V475ZEPS  | C3216Y5V475ZEP | 1V, 1kHz            | 4.7         | uF   | +80%/-20%           | 1.15        | ±0.20         | ±0.15  | 12.5%     | Embossed, 3Kpcs  | (I)             |      |
|     | C3216Y5V106ZEPS  | C3216Y5V106ZEP | 1V, 1kHz            | 10          | uF   | +80%/-20%           | 1.15        | ±0.20         | ±0.20  | 12.5%     |                  | (I)             |      |
|     | C3216Y5V226ZEPS  | C3216Y5V226ZEP | 0.5V, 120Hz         | 22          | uF   | +80%/-20%           | 1.60        | ±0.30         | ±0.30  | 12.5%     |                  | Embossed, 2Kpcs | (I)  |
| 10V | C3216Y5V475ZDPS  | C3216Y5V475ZDP | 1V, 1kHz            | 4.7         | uF   | +80%/-20%           | 1.15        | ±0.20         | ±0.15  | 12.5%     | Embossed, 3Kpcs  | (I)             |      |
|     | C3216Y5V226ZDPS  | C3216Y5V226ZDP | 0.5V, 120Hz         | 22          | uF   | +80%/-20%           | 1.60        | ±0.30         | ±0.30  | 20.0%     | Embossed, 2Kpcs  | (II)            |      |

● C3225Y5V Series (EIA1210)

| RV   | DARFON P/N      | DARFON P/N 2   | Measuring Condition | Capacitance |      | Available Tolerance | Thick. (mm) | Tolerance(mm) |        | DF (max.) | Standard Packing | Test Spec. |
|------|-----------------|----------------|---------------------|-------------|------|---------------------|-------------|---------------|--------|-----------|------------------|------------|
|      |                 |                |                     | Value       | Unit |                     |             | L/W           | Thick. |           |                  |            |
| 35V  | C3225Y5V106ZNPS | C3225Y5V106ZNP | 1V, 1kHz            | 10          | uF   | +80%/-20%           | 1.60        | ±0.20         | ±0.20  | 9.0%      | Embossed, 2Kpcs  | (I)        |
| 6.3V | C3225Y5V476ZCWS | C3225Y5V476ZCW | 0.5V, 120Hz         | 47          | uF   | +80%/-20%           | 2.00        | ±0.40/±0.30   | ±0.20  | 20.0%     | Embossed, 1Kpcs  | (II)       |

(II)\* High temperature load life test are applicable in rated voltage \*100%

- Test Spec.
- General Purpose (I)

| Item | Specification                           |  | Test Method  |  |   |   |      |     |     |     |      |     |     |     |      |     |     |     |      |     |     |      |      |     |     |     |      |     |     |     |      |     |     |     |  |
|------|---|--|--|--|---|---|------|-----|-----|-----|------|-----|-----|-----|------|-----|-----|-----|------|-----|-----|------|------|-----|-----|-----|------|-----|-----|-----|------|-----|-----|-----|--|
|      | Temp. compensation type                 | High dielectric constant type  |  |  |   |   |      |     |     |     |      |     |     |     |      |     |     |     |      |     |     |      |      |     |     |     |      |     |     |     |      |     |     |     |  |
| 1    | Operation Temperature Range             | NP0: -55 to 125 °C<br>X5R: -55 to 85 °C<br>X6S: -55 to 105 °C<br>X7R/X7S/X7T/X7U<br>: -55 to 125 °C<br>Y5V: -30 to 85 °C   | ---  |  |   |   |      |     |     |     |      |     |     |     |      |     |     |     |      |     |     |      |      |     |     |     |      |     |     |     |      |     |     |     |  |
| 2    | Rated Voltage                           | Shown in the table of "Part Number & Characteristic"   | The rated voltage is defined as the maximum voltage, which may be applied continuously to the capacitor.   |  |   |   |      |     |     |     |      |     |     |     |      |     |     |     |      |     |     |      |      |     |     |     |      |     |     |     |      |     |     |     |  |
| 3    | Appearance                              | No defects or abnormalities.   | Visual inspection  |  |   |   |      |     |     |     |      |     |     |     |      |     |     |     |      |     |     |      |      |     |     |     |      |     |     |     |      |     |     |     |  |
| 4    | Dimensions                              | Within the specified dimension.  | Using calipers   |  |   |   |      |     |     |     |      |     |     |     |      |     |     |     |      |     |     |      |      |     |     |     |      |     |     |     |      |     |     |     |  |
| 5    | Dielectric Strength                     | No defects or abnormalities.   | No failure shall be observed when 250% of the rated voltage is applied between the terminations for 1 to 5 seconds. The charge and discharge current is less than 50mA.  |  |   |   |      |     |     |     |      |     |     |     |      |     |     |     |      |     |     |      |      |     |     |     |      |     |     |     |      |     |     |     |  |
| 6    | Insulation Resistance ( I.R.)           | To apply rated voltage.<br>I.R. $\geq 10G\Omega$ or $R_C R_R \geq 500\Omega \cdot F$ (whichever is smaller)  | The insulation resistance shall be measured with a DC voltage not exceeding the rated voltage at 25°C and 75%RH max, and within 1 minute of charging.  |  |   |   |      |     |     |     |      |     |     |     |      |     |     |     |      |     |     |      |      |     |     |     |      |     |     |     |      |     |     |     |  |
| 7    | Capacitance                             | Within the specified tolerance<br>* X5R, X6S, X7RS, X7S, X7T, X7U and Y5V at 1000 hours  | The capacitance / D.F. shall be measured at 25°C at the frequency and voltage shown in the table of "Part Number & Characteristic".  |  |   |   |      |     |     |     |      |     |     |     |      |     |     |     |      |     |     |      |      |     |     |     |      |     |     |     |      |     |     |     |  |
| 8    | Q/Dissipation Factor ( D.F.)            | NP0:<br>If $C \leq 30pF$ , $DF \leq 1/(400+20C)$ ,<br>C in pF<br>If $C > 30pF$ , $DF \leq 0.1\%$ .   | Shown in the table of "Part Number & Characteristic"   |  |   |   |      |     |     |     |      |     |     |     |      |     |     |     |      |     |     |      |      |     |     |     |      |     |     |     |      |     |     |     |  |
| 9    | Capacitance Temperature Characteristics | Capacitance change<br>NP0 within $0 \pm 30ppm/^\circ C$ under operating temperature range.<br>X5R/X7R within $\pm 15\%$<br>X6S/X7S within $\pm 22\%$<br>X7T: -33% to + 22%<br>X7U: -56% to + 22%<br>Y5V: -82 to + 22%  | 1. Temperature compensation type:<br>The capacitance value at 25°C and 85°C shall be measured and calculated from the formula given below.<br>$T.C. = (C_{85} - C_{25}) / C_{25} \cdot \Delta T \cdot 10^6 (PPM/^\circ C)$<br>2. High dielectric constant type:<br>The ranges of capacitance change compared with the 25°C value over the temperature ranges shall be within the specified ranges.                 |  |   |   |      |     |     |     |      |     |     |     |      |     |     |     |      |     |     |      |      |     |     |     |      |     |     |     |      |     |     |     |  |
| 10   | Termination Strength                    | No removal of the terminations or marking defect.  | Apply a parallel force of 5N to a PCB mounted sample for $10 \pm 1$ sec.<br>*2N for 0603 (EIA 0201).   |  |   |   |      |     |     |     |      |     |     |     |      |     |     |     |      |     |     |      |      |     |     |     |      |     |     |     |      |     |     |     |  |
| 11   | Deflection (Bending Strength)           | No cracking or marking defects shall occur at 1mm deflection.<br>Capacitance change:<br>NP0: within $\pm 5\%$ or $\pm 0.5pF$ . (whichever is larger)<br>X5R, X6S, X7R, X7S, X7T, X7U: within $\pm 12.5\%$<br>Y5V: within $\pm 20\%$  | Solder the capacitor to the test jig (glass epoxy boards) shown in Fig.a using a SAC305(Sn96.5Ag3.0Cu0.5) solder (then let sit for $24 \pm 2$ hours for X5R, X6S, X7R, X7S, X7T, X7U and Y5V).<br>Then apply a force in the direction shown in Fig.b. The soldering shall be done with the reflow method and shall be conducted with care so that the soldering is uniform and free of defects such as heat shock. |  |   |   |      |     |     |     |      |     |     |     |      |     |     |     |      |     |     |      |      |     |     |     |      |     |     |     |      |     |     |     |  |
|      |   | (Unit in mm)<br><br>Fig. a.  | <br>Fig. b.  |  |   |   |      |     |     |     |      |     |     |     |      |     |     |     |      |     |     |      |      |     |     |     |      |     |     |     |      |     |     |     |  |
|      |   | <table border="1"> <thead> <tr> <th>Size</th> <th>a</th> <th>b</th> <th>C</th> </tr> </thead> <tbody> <tr> <td>0603</td> <td>0.3</td> <td>0.9</td> <td>0.3</td> </tr> <tr> <td>1005</td> <td>0.4</td> <td>1.5</td> <td>0.5</td> </tr> <tr> <td>1608</td> <td>1.0</td> <td>3.0</td> <td>1.2</td> </tr> <tr> <td>2012</td> <td>1.2</td> <td>4.0</td> <td>1.65</td> </tr> <tr> <td>3216</td> <td>2.2</td> <td>5.0</td> <td>2.0</td> </tr> <tr> <td>4520</td> <td>3.5</td> <td>7.0</td> <td>2.5</td> </tr> <tr> <td>4532</td> <td>3.5</td> <td>7.0</td> <td>3.7</td> </tr> </tbody> </table> | Size   | a  | b | C | 0603 | 0.3 | 0.9 | 0.3 | 1005 | 0.4 | 1.5 | 0.5 | 1608 | 1.0 | 3.0 | 1.2 | 2012 | 1.2 | 4.0 | 1.65 | 3216 | 2.2 | 5.0 | 2.0 | 4520 | 3.5 | 7.0 | 2.5 | 4532 | 3.5 | 7.0 | 3.7 |  |
| Size | a                                       | b  | C  |  |   |   |      |     |     |     |      |     |     |     |      |     |     |     |      |     |     |      |      |     |     |     |      |     |     |     |      |     |     |     |  |
| 0603 | 0.3                                     | 0.9  | 0.3  |  |   |   |      |     |     |     |      |     |     |     |      |     |     |     |      |     |     |      |      |     |     |     |      |     |     |     |      |     |     |     |  |
| 1005 | 0.4                                     | 1.5  | 0.5  |  |   |   |      |     |     |     |      |     |     |     |      |     |     |     |      |     |     |      |      |     |     |     |      |     |     |     |      |     |     |     |  |
| 1608 | 1.0                                     | 3.0  | 1.2  |  |   |   |      |     |     |     |      |     |     |     |      |     |     |     |      |     |     |      |      |     |     |     |      |     |     |     |      |     |     |     |  |
| 2012 | 1.2                                     | 4.0  | 1.65   |  |   |   |      |     |     |     |      |     |     |     |      |     |     |     |      |     |     |      |      |     |     |     |      |     |     |     |      |     |     |     |  |
| 3216 | 2.2                                     | 5.0  | 2.0  |  |   |   |      |     |     |     |      |     |     |     |      |     |     |     |      |     |     |      |      |     |     |     |      |     |     |     |      |     |     |     |  |
| 4520 | 3.5                                     | 7.0  | 2.5  |  |   |   |      |     |     |     |      |     |     |     |      |     |     |     |      |     |     |      |      |     |     |     |      |     |     |     |      |     |     |     |  |
| 4532 | 3.5                                     | 7.0  | 3.7  |  |   |   |      |     |     |     |      |     |     |     |      |     |     |     |      |     |     |      |      |     |     |     |      |     |     |     |      |     |     |     |  |
| 12   | Solderability of Termination            | 90% of the terminations are to be soldered evenly and continuously.  | Immerse the test capacitor into a methanol solution containing rosin for 3 to 5 seconds, preheat it 150 to 180°C for 2 to 3 minutes and immerse it into SAC305(Sn96.5Ag3.0Cu0.5) solder of $245 \pm 5^\circ C$ for $3 \pm 1$ seconds.  |  |   |   |      |     |     |     |      |     |     |     |      |     |     |     |      |     |     |      |      |     |     |     |      |     |     |     |      |     |     |     |  |
| 13   | Resistance to Soldering Heat            | Appearance<br>No marking defects<br>Cap. Change<br>NP0 within $\pm 2.5\%$ or $0.25pF$ ( whichever is larger )<br>X5R/X6S/X7R/X7S/X7T/X7U within $\pm 7.5\%$<br>Y5V within $\pm 20\%$<br>Q/D.F.<br>If $C \leq 30pF$ , $DF \leq 1/(400+20C)$<br>If $C > 30pF$ , $DF \leq 0.1\%$<br>I.R.<br>I.R. $\geq 10,000M\Omega$ or $R_C R_R \geq 500\Omega \cdot F$ . (whichever is smaller)  | To satisfy the specified initial spec.<br>I.R. $\geq 10,000M\Omega$ or $R_C R_R \geq 500\Omega \cdot F$ . (whichever is smaller)   | *Preheat the capacitor at 120 to 150°C for 1 minute.<br>Immerse the capacitor in a SAC305(Sn96.5Ag3.0Cu0.5) solder solution at $270 \pm 5^\circ C$ for $10 \pm 1$ seconds. Let sit at room temperature for $24 \pm 2$ hours, then measure.<br>* Preheat 150 to 200°C for size $\geq 3216$ .<br>*High dielectric constant type:<br>Initial measurement : perform a heat treatment at $150 \pm 0/-10^\circ C$ for one hour and then let sit for $24 \pm 2$ hours at room temperature. Perform the initial measurement. |   |   |      |     |     |     |      |     |     |     |      |     |     |     |      |     |     |      |      |     |     |     |      |     |     |     |      |     |     |     |  |

|    | Item                                 | Specification           |   | Test Method  |  |
|----|--------------------------------------|-------------------------|---|--|--|
|    |                                      | Temp. compensation type | High dielectric constant type   |  |  |
| 14 | Temperature cycle<br>(Thermal shock) | Appearance              | No marking defects  |  | Solder the capacitor to supporting jig (Glass epoxy board) and perform the five cycles according to the four heat treatments listed in the following table. Let sit for 24±2hrs at room temperature, then measure.<br>Step 1: Minimum operating temperature 30±3min<br>Step 2: Room temperature 2~3 min<br>Step 3: Maximum operating temperature 30±3min<br>Step 4: Room temperature 2~3min<br>*High dielectric constant type:<br>Initial measurement: perform a heat treatment at 150±10°C for one hour and then let sit for 24±2 hours at room temp. Perform the initial measurement.          |
|    |                                      | Cap. Change             | NPO within ±2.5% or 0.25pF ( whichever is larger )  | X5R/X6S/X7R/X7S/X7T within ±7.5%<br>X7U within ±30%<br>Y5V within ±20%             |  |
|    |                                      | Q/D.F.                  | If C ≤ 30pF, DF ≤ 1/(400+20C)<br>If C > 30pF, DF ≤ 0.1%   | To satisfy the specified initial spec.   |  |
|    |                                      | I.R.                    | I.R. ≥ 10GΩ or R <sub>C</sub> R ≥ 500Ω-F.<br>(whichever is smaller)   | I.R. ≥ 10GΩ or R <sub>C</sub> R ≥ 500Ω-F.<br>(whichever is smaller)                |  |
| 15 | Humidity load                        | Appearance              | No marking defects  |  | Apply the rated voltage at 40±2°C and 90 to 95% humidity for 500±12 hours. The charge / discharge current is less than 50mA.<br>[Temperature compensation type]<br>Remove and let sit for 24±2 hours at room temperature, then measure.<br>[High dielectric constant type]<br>*Initial measurement<br>Perform a heat treatment at 150+0/-10°C for one hour and then let sit for 24±2 hours at room temperature.<br>Perform the initial measurement.<br>*Measurement after test<br>Perform a heat treatment and then let sit for 24±2 hours at room temperature, then measure.                    |
|    |                                      | Cap. Change             | NPO within ±7.5% or 0.75pF ( whichever is larger )  | X5R/X6S/X7R/X7S/X7T/X7U within ±12.5%<br>Y5V within ±30%                           |  |
|    |                                      | Q/D.F.                  | If C > 30pF, DF ≤ 0.5%<br>If C ≤ 30pF, DF ≤ 1/(100+10xC/3)<br>C in pF   | X5R/X6S/X7R/X7S/X7T/X7U 200% max of initial spec.<br>Y5V 150% max of initial spec. |  |
|    |                                      | I.R.                    | I.R. ≥ 500MΩ or R <sub>C</sub> R ≥ 25Ω-F.<br>(whichever is smaller)   | I.R. ≥ 500MΩ or R <sub>C</sub> R ≥ 25Ω-F.<br>(whichever is smaller)                |  |
| 16 | High temperature load life test      | Appearance              | No marking defects  |  | Apply 200% of the rated voltage for 1000±12 hours at the maximum operating temperature ± 3°C. The charge / discharge current is less than 50mA.<br>[Temperature compensation type]<br>Remove and let sit for 24±2 hours at room temperature, then measure.<br>[High dielectric constant type]<br>*Initial measurement<br>Perform a heat treatment at 150+0/-10°C for one hour and then let sit for 24±2 hours at room temperature.<br>Perform the initial measurement.<br>*Measurement after test<br>Perform a heat treatment and then let sit for 24±2 hours at room temperature, then measure. |
|    |                                      | Cap. Change             | NPO within ±7.5% or 0.75pF ( whichever is larger )  | X5R/X6S/X7R/X7S/X7T/X7U within ±12.5%<br>Y5V within ±30%                           |  |
|    |                                      | Q/D.F.                  | If C > 30pF, DF ≤ 0.3%<br>If 10pF < C ≤ 30pF, DF ≤ 1/(275+5xC/2)<br>If C ≤ 10pF, DF ≤ 1/(200+10C),<br>C in pF | X5R/X6S/X7R/X7S/X7T/X7U 200% max of initial spec.<br>Y5V 150% max of initial spec. |  |
|    |                                      | I.R.                    | More than 1GΩ or R <sub>C</sub> R ≥ 50Ω-F (whichever is less.)  | More than 1GΩ or R <sub>C</sub> R ≥ 50Ω-F (whichever is less.)                     |  |

● General Purpose (II)

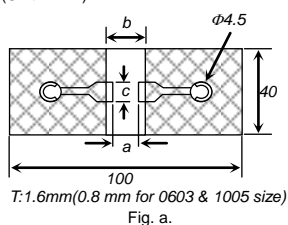
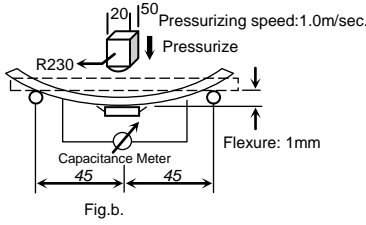
| Item | Specification  | Test Method  |      |   |   |   |      |     |     |     |      |     |     |     |      |     |     |     |      |     |     |      |      |     |     |     |      |     |     |     |      |     |     |     |
|------|--|--|------|---|---|---|------|-----|-----|-----|------|-----|-----|-----|------|-----|-----|-----|------|-----|-----|------|------|-----|-----|-----|------|-----|-----|-----|------|-----|-----|-----|
| 1    | <b>Operation Temperature Range</b><br>X5R: -55 to 85 °C<br>X6S: -55 to 105 °C<br>X7R/X7S/X7T/X7U: -55 to 125 °C<br>Y5V: -30 to 85 °C | ---  |      |   |   |   |      |     |     |     |      |     |     |     |      |     |     |     |      |     |     |      |      |     |     |     |      |     |     |     |      |     |     |     |
| 2    | <b>Rated Voltage</b>   | Shown in the table of "Part Number & Characteristic"   |      |   |   |   |      |     |     |     |      |     |     |     |      |     |     |     |      |     |     |      |      |     |     |     |      |     |     |     |      |     |     |     |
| 3    | <b>Appearance</b>  | No defects or abnormalities.   |      |   |   |   |      |     |     |     |      |     |     |     |      |     |     |     |      |     |     |      |      |     |     |     |      |     |     |     |      |     |     |     |
| 4    | <b>Dimensions</b>  | Within the specified dimension.  |      |   |   |   |      |     |     |     |      |     |     |     |      |     |     |     |      |     |     |      |      |     |     |     |      |     |     |     |      |     |     |     |
| 5    | <b>Dielectric Strength</b>   | No defects or abnormalities.   |      |   |   |   |      |     |     |     |      |     |     |     |      |     |     |     |      |     |     |      |      |     |     |     |      |     |     |     |      |     |     |     |
| 6    | <b>Insulation Resistance ( I.R.)</b>   | No failure shall be observed when 250% of the rated voltage is applied between the terminations for 1 to 5 seconds. The charge and discharge current is less than 50mA.  |      |   |   |   |      |     |     |     |      |     |     |     |      |     |     |     |      |     |     |      |      |     |     |     |      |     |     |     |      |     |     |     |
| 7    | <b>Capacitance</b>   | The insulation resistance shall be measured with a DC voltage not exceeding the rated voltage at 25°C and 75%RH max, and within 1 minute of charging, provided the charge/discharge current is less than 50 mA.  |      |   |   |   |      |     |     |     |      |     |     |     |      |     |     |     |      |     |     |      |      |     |     |     |      |     |     |     |      |     |     |     |
| 8    | <b>Q/Dissipation Factor ( D.F.)</b>  | The capacitance / D.F. shall be measured at 25°C at the frequency and voltage shown in the table of "Part Number & Characteristic".  |      |   |   |   |      |     |     |     |      |     |     |     |      |     |     |     |      |     |     |      |      |     |     |     |      |     |     |     |      |     |     |     |
| 9    | <b>Capacitance Temperature Characteristics</b>   | Shown in the table of "Part Number & Characteristic"   |      |   |   |   |      |     |     |     |      |     |     |     |      |     |     |     |      |     |     |      |      |     |     |     |      |     |     |     |      |     |     |     |
| 10   | <b>Termination Strength</b>  | Capacitance change<br>X5R/X7R within ±15% , X6S/X7S within ±22%<br>X7U: -56% to + 22%<br>X7T: -33% to + 22%<br>Y5V: -82% to + 22%  |      |   |   |   |      |     |     |     |      |     |     |     |      |     |     |     |      |     |     |      |      |     |     |     |      |     |     |     |      |     |     |     |
| 11   | <b>Deflection (Bending Strength)</b>   | No removal of the terminations or marking defect.<br>Apply a parallel force of 5N to a PCB mounted sample for 10±1sec. *2N for 0603 (EIA 0201).  |      |   |   |   |      |     |     |     |      |     |     |     |      |     |     |     |      |     |     |      |      |     |     |     |      |     |     |     |      |     |     |     |
| 12   | <b>Solderability of Termination</b>  | No cracking or marking defects shall occur at 1mm deflection.<br>Capacitance change:<br>X5R, X6S, X7R, X7S, X7T, X7U :within ±12.5%<br>Y5V: within±20%   |      |   |   |   |      |     |     |     |      |     |     |     |      |     |     |     |      |     |     |      |      |     |     |     |      |     |     |     |      |     |     |     |
| 13   | <b>Resistance to Soldering Heat</b>  | (Unit in mm)<br> <table border="1" data-bbox="774 1176 981 1355"> <thead> <tr> <th>Size</th> <th>a</th> <th>b</th> <th>C</th> </tr> </thead> <tbody> <tr> <td>0603</td> <td>0.3</td> <td>0.9</td> <td>0.3</td> </tr> <tr> <td>1005</td> <td>0.4</td> <td>1.5</td> <td>0.5</td> </tr> <tr> <td>1608</td> <td>1.0</td> <td>3.0</td> <td>1.2</td> </tr> <tr> <td>2012</td> <td>1.2</td> <td>4.0</td> <td>1.65</td> </tr> <tr> <td>3216</td> <td>2.2</td> <td>5.0</td> <td>2.0</td> </tr> <tr> <td>4520</td> <td>3.5</td> <td>7.0</td> <td>2.5</td> </tr> <tr> <td>4532</td> <td>3.5</td> <td>7.0</td> <td>3.7</td> </tr> </tbody> </table>  | Size | a | b | C | 0603 | 0.3 | 0.9 | 0.3 | 1005 | 0.4 | 1.5 | 0.5 | 1608 | 1.0 | 3.0 | 1.2 | 2012 | 1.2 | 4.0 | 1.65 | 3216 | 2.2 | 5.0 | 2.0 | 4520 | 3.5 | 7.0 | 2.5 | 4532 | 3.5 | 7.0 | 3.7 |
| Size | a  | b  | C    |   |   |   |      |     |     |     |      |     |     |     |      |     |     |     |      |     |     |      |      |     |     |     |      |     |     |     |      |     |     |     |
| 0603 | 0.3  | 0.9  | 0.3  |   |   |   |      |     |     |     |      |     |     |     |      |     |     |     |      |     |     |      |      |     |     |     |      |     |     |     |      |     |     |     |
| 1005 | 0.4  | 1.5  | 0.5  |   |   |   |      |     |     |     |      |     |     |     |      |     |     |     |      |     |     |      |      |     |     |     |      |     |     |     |      |     |     |     |
| 1608 | 1.0  | 3.0  | 1.2  |   |   |   |      |     |     |     |      |     |     |     |      |     |     |     |      |     |     |      |      |     |     |     |      |     |     |     |      |     |     |     |
| 2012 | 1.2  | 4.0  | 1.65 |   |   |   |      |     |     |     |      |     |     |     |      |     |     |     |      |     |     |      |      |     |     |     |      |     |     |     |      |     |     |     |
| 3216 | 2.2  | 5.0  | 2.0  |   |   |   |      |     |     |     |      |     |     |     |      |     |     |     |      |     |     |      |      |     |     |     |      |     |     |     |      |     |     |     |
| 4520 | 3.5  | 7.0  | 2.5  |   |   |   |      |     |     |     |      |     |     |     |      |     |     |     |      |     |     |      |      |     |     |     |      |     |     |     |      |     |     |     |
| 4532 | 3.5  | 7.0  | 3.7  |   |   |   |      |     |     |     |      |     |     |     |      |     |     |     |      |     |     |      |      |     |     |     |      |     |     |     |      |     |     |     |

| Item |                                      | Specification | Test Method   |
|------|--------------------------------------|---------------|---|
| 14   | Temperature cycle<br>(Thermal shock) | Appearance    | Solder the capacitor to supporting jig (Glass epoxy board) and perform the five cycles according to the four heat treatments listed in the following table.<br>Let sit for 24±2hrs at room temperature, then measure.<br>Step 1: Minimum operating temperature      30±3min<br>Step 2: Room temperature                              2-3 min<br>Step 3: Maximum operating temperature      30±3min<br>Step 4: Room temperature                              2-3min<br>* Initial measurement: perform a heat treatment at 150±10°C for one hour and then let sit for 24±2 hours at room temp. Perform the initial measurement. |
|      |                                      | Cap. Change   |   |
|      |                                      | Q/D.F.        |   |
|      |                                      | I.R.          |   |
| 15   | Humidity load                        | Appearance    | Apply the rated voltage at 40±2°C and 90 to 95% humidity for 500±12 hours. The charge / discharge current is less than 50mA.<br><br>*Initial measurement<br>Perform a heat treatment at 150+0/-10°C for one hour and then let sit for 24±2 hours at room temperature.<br>Perform the initial measurement.<br>*Measurement after test<br>Perform a heat treatment and then let sit for 24±2 hours at room temperature, then measure.   |
|      |                                      | Cap. Change   |   |
|      |                                      | Q/D.F.        |   |
|      |                                      | I.R.          |   |
| 16   | High temperature<br>load life test   | Appearance    | Apply 150% of the rated voltage for 1000±12 hours at the maximum operating temperature ± 3°C. The charge / discharge current is less than 50mA.<br><br>*Initial measurement<br>Perform a heat treatment at 150+0/-10°C for one hour and then let sit for 24±2 hours at room temperature.<br>Perform the initial measurement.<br>*Measurement after test<br>Perform a heat treatment and then let sit for 24±2 hours at room temperature, then measure.<br>* Some of the parts are applicable in rated voltage *100%. Please refer to "Part Number & Characteristic" with (II)* labeled in "Test Spec."                        |
|      |                                      | Cap. Change   |   |
|      |                                      | D.F.          |   |
|      |                                      | I.R.          |   |

## Package

- Tape and reel packaging**

Tape and reel packaging is currently the most promising system for high-speed production. A typical 180mm (7 inch) diameter reel contains 1,500 to 15,000 capacitors, 250mm (10 inch) contains 10,000 capacitors, and 330mm (13 inch) contains 10,000 to 50,000 capacitors. Three standard sizes are available in taped and reeled package either with paper carrier tapes or embossed tapes.

### 【Paper tape specifications】



| SYMBOL | PRODUCT SIZE CODE |        |                      |        |                         |        |                         |        |                         |        | UNIT |
|--------|-------------------|--------|----------------------|--------|-------------------------|--------|-------------------------|--------|-------------------------|--------|------|
|        | C0603(0201)       |        | C1005(0402) Standard |        | C1005(0402) Special (1) |        | C1005(0402) Special (2) |        | C1005(0402) Special (3) |        |      |
|        | SIZE              | TOL.   | SIZE                 | TOL.   | SIZE                    | TOL.   | SIZE                    | TOL.   | SIZE                    | TOL.   |      |
| A      | 0.38              | ± 0.04 | 0.65                 | ± 0.10 | 0.70                    | ± 0.10 | 0.72                    | ± 0.10 | 0.80                    | ± 0.10 | mm   |
| B      | 0.68              | ± 0.04 | 1.15                 | ± 0.10 | 1.19                    | ± 0.10 | 1.25                    | ± 0.10 | 1.35                    | ± 0.10 | mm   |
| F      | 3.5               | ± 0.05 | 3.5                  | ± 0.05 | 3.5                     | ± 0.05 | 3.5                     | ± 0.05 | 3.5                     | ± 0.05 | mm   |
| P      | 2                 | ± 0.10 | 2                    | ± 0.10 | 2                       | ± 0.10 | 2                       | ± 0.10 | 2                       | ± 0.10 | mm   |
| W      | 8                 | ± 0.20 | 8                    | ± 0.20 | 8                       | ± 0.20 | 8                       | ± 0.20 | 8                       | ± 0.20 | mm   |

| SYMBOL | PRODUCT SIZE CODE (EIA) |       |                          |       |                            |       |              |       |              |       | UNIT |
|--------|-------------------------|-------|--------------------------|-------|----------------------------|-------|--------------|-------|--------------|-------|------|
|        | C1608(0603) Standard    |       | C1608 (0603) Special (1) |       | C1608 (0603) Special (2/3) |       | C2012 (0805) |       | C3216 (1206) |       |      |
|        | SIZE                    | TOL.  | SIZE                     | TOL.  | SIZE                       | TOL.  | SIZE         | TOL.  | SIZE         | TOL.  |      |
| A      | 1.0                     | ±0.2  | 1.0                      | ±0.2  | 1.1                        | ±0.2  | 1.5          | ±0.2  | 1.9          | ±0.2  | mm   |
| B      | 1.8                     | ±0.2  | 1.8                      | ±0.2  | 1.9                        | ±0.2  | 2.3          | ±0.2  | 3.6          | ±0.2  | mm   |
| F      | 3.5                     | ±0.05 | 3.5                      | ±0.05 | 3.5                        | ±0.05 | 3.5          | ±0.05 | 3.5          | ±0.05 | mm   |
| P      | 4                       | ±0.1  | 4                        | ±0.1  | 4                          | ±0.1  | 4            | ±0.1  | 4            | ±0.1  | mm   |
| W      | 8                       | ±0.2  | 8                        | ±0.2  | 8                          | ±0.2  | 8            | ±0.2  | 8            | ±0.2  | mm   |

**【 Embossed tape specifications 】**

1mm and 4mm and 8mm pitch tape



For  $W=8\text{mm}$ :  $T_1=2.5\text{mm max.}$

For  $W=12\text{mm}$ :  $T_1=4.5\text{mm}$

| DIMENSION<br>(mm) | PRODUCT SIZE CODE  |                    |                    |                    |                    |                    |
|-------------------|--------------------|--------------------|--------------------|--------------------|--------------------|--------------------|
|                   | 4 mm tape          |                    |                    |                    | 8 mm tape          |                    |
|                   | 1608<br>(0603)     | 2012<br>(0805)     | 3216<br>(1206)     | 3225<br>(1210)     | 4520<br>(1808)     | 4532<br>(1812)     |
| $P_1$             | $4\pm 0.1$         | $4\pm 0.1$         | $4\pm 0.1$         | $4\pm 0.1$         | $8\pm 0.1$         | $8\pm 0.1$         |
| $P_0$             | $4\pm 0.1$         | $4\pm 0.1$         | $4\pm 0.1$         | $4\pm 0.1$         | $4\pm 0.1$         | $4\pm 0.1$         |
| $P_2$             | $2\pm 0.05$        | $2\pm 0.05$        | $2\pm 0.05$        | $2\pm 0.05$        | $2\pm 0.05$        | $2\pm 0.05$        |
| $A$               | $1.2\pm 0.2$       | $1.45\pm 0.2$      | $1.9\pm 0.2$       | $2.8\pm 0.2$       | $2.3\pm 0.2$       | $3.6\pm 0.2$       |
| $B$               | $2.0\pm 0.2$       | $2.3\pm 0.2$       | $3.5\pm 0.2$       | $3.6\pm 0.2$       | $4.9\pm 0.2$       | $4.9\pm 0.2$       |
| $W$               | $8\pm 0.3$         | $8\pm 0.2$         | $8\pm 0.2$         | $8\pm 0.2$         | $12\pm 0.2$        | $12\pm 0.2$        |
| $E$               | $1.75\pm 0.1$      | $1.75\pm 0.1$      | $1.75\pm 0.1$      | $1.75\pm 0.1$      | $1.75\pm 0.1$      | $1.75\pm 0.1$      |
| $F$               | $3.5\pm 0.05$      | $3.5\pm 0.05$      | $3.5\pm 0.05$      | $3.5\pm 0.05$      | $5.5\pm 0.05$      | $5.5\pm 0.05$      |
| $D$               | 1.5<br>(+0.1/-0.0) | 1.5<br>(+0.1/-0.0) | 1.5<br>(+0.1/-0.0) | 1.5<br>(+0.1/-0.0) | 1.5<br>(+0.1/-0.0) | 1.5<br>(+0.1/-0.0) |
| $T_1$             | 1.4 max.           | 2.5 max.           | 2.5 max.           | 2.5 max.           | 4.5                | 4.5                |
| $T_2$             | $0.25\pm 0.1$      | $0.305\pm 0.1$     | $0.30\pm 0.1$      | $0.30\pm 0.1$      | $0.30\pm 0.1$      | $0.30\pm 0.1$      |



**【Reel specifications】**

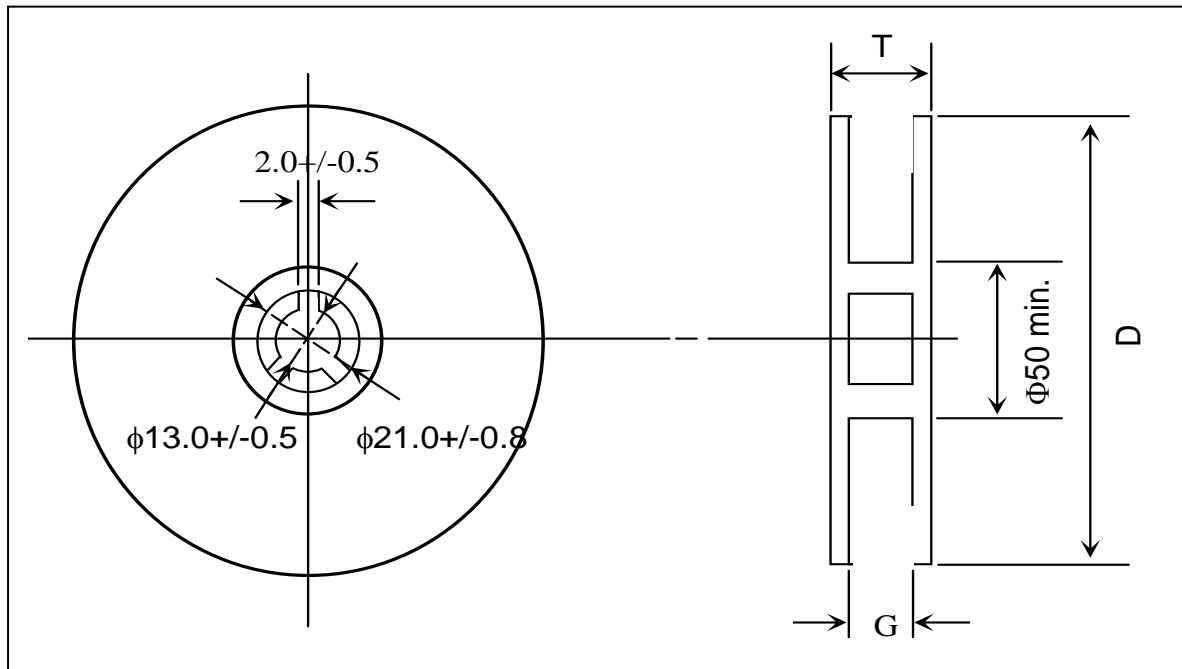

| TAPE WIDTH (mm) | G (mm)         | T max. (mm) | D (mm) |
|-----------------|----------------|-------------|--------|
| 4               | $5.0 \pm 1.5$  | 8.0         | 180    |
| 8               | $10.0 \pm 1.5$ | 14.5        | 180    |
| 8               | $10.0 \pm 1.5$ | 14.5        | 250    |
| 8               | $10.0 \pm 1.5$ | 14.5        | 330    |
| 12              | $14.0 \pm 1.5$ | 18.5        | 180    |

MLCC

**【Thickness and Packing Amount】**

| Thickness |           |              | Amount per reel |                   |              |          |
|-----------|-----------|--------------|-----------------|-------------------|--------------|----------|
| Code      | Spec.(mm) | Size (EIA)   | 180 mm (7")     |                   | 330 mm (13") |          |
|           |           |              | Paper           | Embossed          | Paper        | Embossed |
| Z         | 0.20      | 0402 (01005) | 20K             | 40K <sup>#1</sup> |              |          |
| A         | 0.30      | 0603 (0201)  | 15K             |                   | 50K          |          |
|           |           | 1005 (0402)  | 15K             |                   | 50K          |          |
| B         | 0.50      | 1005 (0402)  | 10K             |                   | 50K          |          |
| Q         | 0.45      | 1005 (0402)  | 10K             |                   | 50K          |          |
|           |           | 1608 (0603)  | 4K              |                   | 15K          |          |
| C         | 0.60      | 2012 (0805)  | 4K              |                   | 15K          |          |
|           |           | 3216 (1206)  | 4K              |                   | 15K          |          |
| D         | 0.80      | 1608 (0603)  | 4K              | 4K                | 15K          |          |
| E         | 0.85      | 2012 (0805)  | 4K              |                   | 15K          |          |
|           |           | 3216 (1206)  | 4K              |                   | 15K          |          |
|           |           | 3225 (1210)  |                 | 3K                |              | 10K      |
| I         | 0.95      | 4532 (1812)  |                 | 1K                |              |          |
|           |           | 2012 (0805)  |                 | 3K                |              |          |
| F         | 1.15      | 3216 (1206)  |                 | 3K                |              |          |
|           |           | 4520 (1808)  |                 | 3K                |              | 10K      |
| G         | 1.25      | 3216 (1206)  |                 | 3K                |              | 10K      |
|           |           | 2012 (0805)  |                 | 2K/3K             |              | 10K      |
|           |           | 3216 (1206)  |                 | 3K                |              | 10K      |
|           |           | 3225 (1210)  |                 | 3K                |              |          |
|           |           | 4520 (1808)  |                 | 2K/3K             |              |          |
|           |           | 4532 (1812)  |                 | 1K                |              |          |
| L         | 1.60      | 3225 (1210)  |                 | 3K                |              |          |
|           |           | 3216 (1206)  |                 | 2K                |              |          |
|           |           | 4520 (1808)  |                 | 2K                |              |          |
|           |           | 4532 (1812)  |                 | 1K                |              |          |
| N         | 2.00      | 3216 (1206)  |                 | 2K/3K             |              |          |
|           |           | 3225 (1210)  |                 | 1K/2K             |              |          |
|           |           | 4520 (1808)  |                 | 1K                |              |          |
|           |           | 4532 (1812)  |                 | 1K                |              |          |
| P         | 2.50      | 3225 (1210)  |                 | 500pcs/1K         |              |          |

#1: 4mm width 1mm pitch Embossed Taping

**【Packing Rule】**

| EIA SIZE | Tape         | Reel Size | Reels/Box | Boxes/ Carton |
|----------|--------------|-----------|-----------|---------------|
| 01005    | Emboss       | 7"        | 8         | 12            |
| 01005    | Paper        | 7"        | 5         | 12            |
| 0201     | Paper        | 7"        | 5         | 12            |
| 0402     | Paper        | 7"        | 5         | 12            |
| 0603     | Paper/Emboss | 7"        | 5         | 12            |
| 0805     | Paper/Emboss | 7"        | 5         | 12            |
| 1206     | Paper/Emboss | 7"        | 5         | 12            |
| 1210     | Emboss       | 7"        | 5         | 12            |
| 1808     | Emboss       | 7"        | 5         | 12            |
| 1812     | Emboss       | 7"        | 5         | 12            |

## Others

### 【Storage】

1. The chip capacitors shall be packaged in carrier tapes or bulk cases.
2. Keep storage place temperatures from +5°C to +35°C, humidity from 45 to 70% RH.
3. The storage atmosphere must be free of gas containing sulfur and chlorine. Also, avoid exposing the product to saline moisture. If the product is exposed to such atmospheres, the terminations will oxidize and solderability will be affected.
4. The solderability is assured for 12 months from our final inspection date if the above storage condition is followed.

### 【Circuit Design】

1. Once application and assembly environments have been checked, the capacitor may be used in conformance with the rating and performance, which are provided in both the catalog and the specifications. Exceeding the specifications listed may result in inferior performance. It may also cause a short, open, smoking, or flaming to occur, etc.
2. Please use the capacitors in conformance with the operating temperature provided in both the catalog and the specifications. Be especially cautious not to exceed the maximum temperature. In the situation the maximum temperature set forth in both the catalog and specifications is exceeded, the capacitor's insulation resistance may deteriorate, power may suddenly surge and short-circuit may occur. The loss of capacitance will occur, and may self-heat due to equivalent series resistance when alternating electric current is passed through. As this effect becomes critical in high frequency circuits, please exercise with caution. When using the capacitor in a (self-heating) circuit, please make sure the surface of the capacitor remains under the maximum temperature for usage. Also, please make certain temperature rise remain below 20°C.
3. Please keep voltage under the rated voltage, which is applied to the capacitor. Also, please make certain the peak voltage remains below the rated voltage when AC voltage is super-imposed to the DC voltage. In the situation where AC or pulse voltage is employed, ensure average peak voltage does not exceed the rated voltage. Exceeding the rated voltage provided in both catalog and specifications may lead to defective withstanding voltage or, in worse case situations, may cause the capacitor to burn out.
4. It's is a common phenomenon of high-dielectric products to have a deteriorated amount of static electricity due to the application of DC voltage.

**【Handling】**

Chip capacitors should be handled with care to avoid contamination or damage. The use of vacuum pick-up or plastic tweezers is recommended for manual placement. Tape and reeled packages are suitable for automatic pick and placement machine.

**【Flux】**

1. An excessive amount of flux or too rapid temperature rise can cause solvent burst, solder can generate a large quantity of gas. The gas can spread small solder particles to cause solder balling effect or bridging problem.
2. Flux containing too high of a percentage of halide may cause corrosion of termination unless sufficient cleaning is applied.
3. Use rosin-type flux. Highly acidic flux (halide content less than 0.2wt%) is not recommended.
4. The water soluble flux causes deteriorated insulation resistance between outer terminations unless sufficiently cleaned.

**【Component Spacing】**

For wave soldering components, the spacing must be sufficient far apart to prevent bridging or shadowing. This is not so important for reflow process but enough space for rework should be considered. The suggested spacing for reflow soldering and wave soldering is 0.5mm and 1.0mm, respectively.

**【Solder Fillet】**

Too much solder amount may increase solder stress and cause crack risk. Insufficient solder amount may reduce adhesive strength and cause parts falling off PCB. When soldering, confirm that the solder is placed over 0.2mm of the surface of the terminations.



## 【Recommended Land Pattern Dimensions】

When mounting the capacitor to substrate, it's important to consider that the amount of solder (size of fillet) used has a direct effect upon the capacitor once it's mounted.

1. The greater the amount of solder, the greater the stress to the elements, as this may cause the substrate to break or crack.
2. In the situation where two or more devices are mounted onto a common land, separate the device into exclusive pads by using soldering resist.
3. Land width equal to or less than component. It is permissible to reduce land width to 80% of component width.



| Size mm (EIA) | L x W (mm)<br>(Dimension tolerance) | a (mm)       | b (mm)       | c (mm)       |
|---------------|-------------------------------------|--------------|--------------|--------------|
| 0402 (01005)  | 0.4*0.2                             | 0.16 to 0.20 | 0.12 to 0.18 | 0.20 to 0.23 |
| 0603 (0201)   | 0.6*0.3                             | 0.15 to 0.35 | 0.2 to 0.3   | 0.25 to 0.3  |
| 1005 (0402)   | 1.0*0.5<br>(within±0.10)            | 0.3 to 0.5   | 0.35 to 0.45 | 0.4 to 0.5   |
|               | 1.0*0.5<br>(±0.15 or ±0.20)         | 0.4 to 0.6   | 0.4 to 0.5   | 0.5 to 0.6   |
| 1608 (0603)   | 1.6*0.8<br>(within±0.10)            | 0.7 to 1.0   | 0.6 to 0.8   | 0.7 to 0.8   |
|               | 1.6*0.8<br>(±0.15 or ±0.20)         | 0.8 to 1.1   | 0.7 to 0.9   | 0.8 to 0.9   |
| 2012 (0805)   | 2.0*1.25                            | 1.0 to 1.3   | 0.7 to 0.9   | 1.0 to 1.2   |
| 3216 (1206)   | 3.2*1.6                             | 2.1 to 2.5   | 1.0 to 1.2   | 1.3 to 1.6   |
| 3225 (1210)   | 3.2*2.5                             | 2.1 to 2.5   | 1.0 to 1.2   | 2.0 to 2.5   |
| 4520 (1808)   | 4.5*2.0                             | 3.2 to 3.8   | 1.2 to 1.4   | 1.7 to 2.0   |
| 4532 (1812)   | 4.5*3.2                             | 3.2 to 3.8   | 1.2 to 1.4   | 2.7 to 3.2   |

## 【Resin Mold】

If a large amount of resin is used for molding the chip, cracks may occur due to contraction stress during curing. To avoid such cracks, use a low shrinkage resin. The insulation resistance of the chip will degrade due to moisture absorption. Use a low moisture absorption resin. Check carefully that the resin does not generate a decomposition gas or reaction gas during the curing process or during normal storage. Such gases may crack the chip capacitor or damage the device itself.

## 【Soldering Profile for SMT Process with SnPb Solder Paste】

### Reflow Soldering



The difference between solder and chip surface should be controlled as following table. The rate of preheat should not exceed 4°C/sec and a target of 2°C/sec is preferred.

| Chip Size  | 3216 and smaller                    | 3225 and above                      |
|------------|-------------------------------------|-------------------------------------|
| Preheating | $\Delta T \leq 150^{\circ}\text{C}$ | $\Delta T \leq 130^{\circ}\text{C}$ |



**Wave Soldering**



| Chip Size  | 3216 and smaller                  | 3225 and above |
|------------|-----------------------------------|----------------|
| Preheating | $\Delta T \leq 150^\circ\text{C}$ | -              |

**Soldering Iron**



| Chip Size  | 3216 and smaller                  | 3225 and above                    |
|------------|-----------------------------------|-----------------------------------|
| Preheating | $\Delta T \leq 190^\circ\text{C}$ | $\Delta T \leq 130^\circ\text{C}$ |

MLCC

**[Soldering]**

**Reflow Soldering for Lead free Termination**



The difference between solder and chip surface should be controlled as following table. The rate of preheat should not exceed 4°C/sec and a target of 2°C/sec is preferred.

| Chip Size  | 3216 and smaller                  | 3225 and above                    |
|------------|-----------------------------------|-----------------------------------|
| Preheating | $\Delta T \leq 150^\circ\text{C}$ | $\Delta T \leq 130^\circ\text{C}$ |

**Flow Soldering for Lead free Termination**

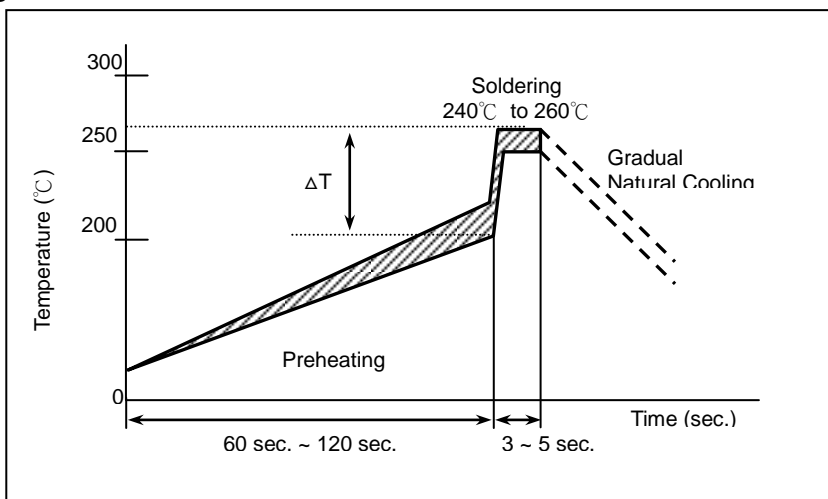

| Chip Size  | 3216 and smaller                  | 3225 and above |
|------------|-----------------------------------|----------------|
| Preheating | $\Delta T \leq 150^\circ\text{C}$ | -              |

**Soldering Iron**

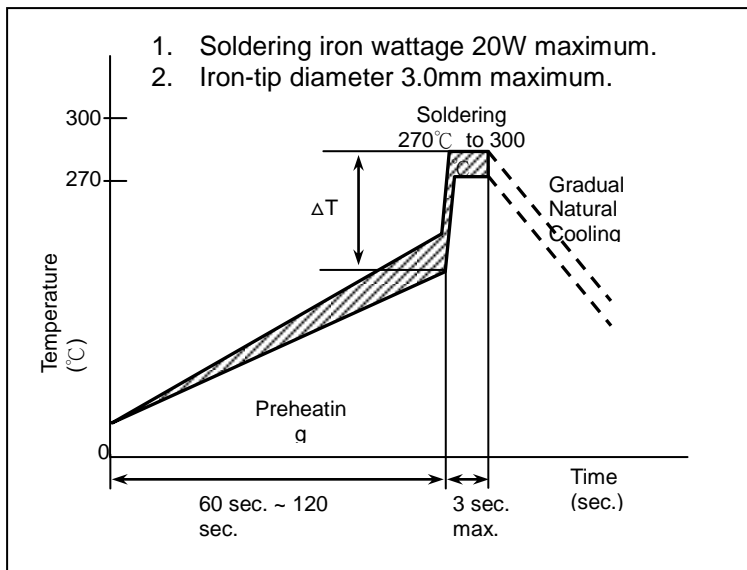

| Chip Size  | 3216 and smaller                    | 3225 and above                      |
|------------|-------------------------------------|-------------------------------------|
| Preheating | $\Delta T \leq 190^{\circ}\text{C}$ | $\Delta T \leq 130^{\circ}\text{C}$ |

**【Chip Layout and Breaking PCB】**

- To layout the SMD capacitors for reducing bend stress from board deflection of PCB. The following are examples of Hood and bad layout.

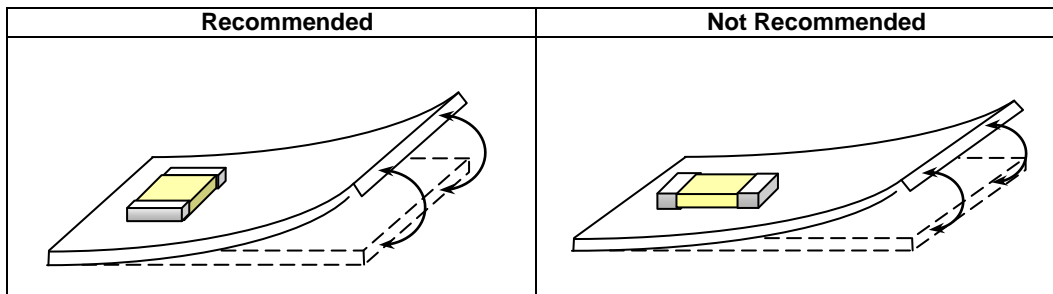

- When breaking PCB, the layout should be noted that the mechanical stresses are depending on the position of capacitors. The following example shows recommendation for better design.

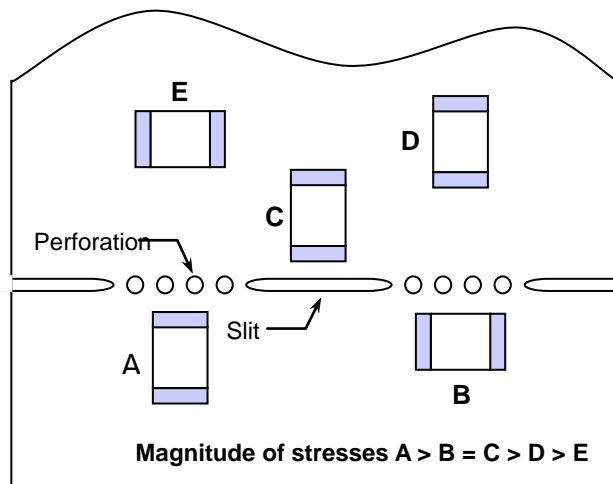

## 【Temperature Coefficient】

- Class 1 (Temperature Compensation series)



- Class 2 (High Dielectric Constant Series)



**[DC Voltage Coefficient]**



**[Aging Rate]**

The capacitance and dissipation factor of class 2 capacitors decreases with time. It is known as 'aging' that follows a logarithmic law and expressed in terms of an aging constant. Aging is caused by a gradual re-alignment of the crystalline structure of the ceramic. The aging constant is defined as the percentage loss of capacitance at a 'time decade'. The law of capacitance aging is expressed as following equation:



$$C_{t2} = C_{t1} \times (1 - k \times \log_{10}(t_2/t_1))$$

$C_{t1}$ : Capacitance after  $t_1$  hours of start aging.

$C_{t2}$ : Capacitance after  $t_2$  hours of start aging.

$k$ : aging constant (capacitance decrease per decade)

$t_1, t_2$ : time in hours from start of aging.

A typical curve of aging rate is shown in following figure.

When heating the capacitors above Curie temperature (130°C~150°C) the capacitance can be re-new. So capacitance of class 2 capacitors will be complete de-aged by soldering process; subsequently a new aging process begins.

Because of aging, it is specified an age for measurement to meet the prescribed tolerance for class 2 capacitors. Normally, 1000 hours ( $t_2=1000$  hrs) is defined.

**【Peeling Off Force】**

Peeling off force: 0.1N to 1.0 N\* in the direction shown as below.

The peeling speed: 300±10 mm/min

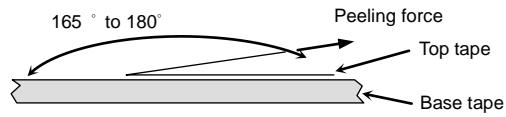

1. The taped tape on reel is wound clockwise. The sprocket holes are to the right as the tape is pulled toward the user.
2. There are minimum 150 mm as the leader and minimum 40 mm empty tape as the tail is attached to the end of the tape.



## X-ON Electronics

Largest Supplier of Electrical and Electronic Components

*Click to view similar products for [Multilayer Ceramic Capacitors MLCC - SMD/SMT](#) category:*

*Click to view products by [Darfon](#) manufacturer:*

Other Similar products are found below :

[M39014/02-1225V](#) [M39014/22-0631](#) [D55342E07B523DR-T/R](#) [NCA1206X7R103K50TRPF](#) [NCA1206X7R104K16TRPF](#) [NIN-FB391JTRF](#)  
[NIN-FC2R7JTRF](#) [NMC0201X5R474K4TRPF](#) [NMC0402NPO220J50TRPF](#) [NMC0402X5R105K6.3TRPF](#) [NMC0402X5R224K6.3TRPF](#)  
[NMC0402X7R103J25TRPF](#) [NMC0402X7R153K16TRPF](#) [NMC0603NPO1R8C50TRPF](#) [NMC0603NPO201J50TRPF](#)  
[NMC0603NPO330G50TRPF](#) [NMC0603X5R475M6.3TRPF](#) [NMC0805NPO270J50TRPF](#) [NMC0805NPO820J50TRPF](#)  
[NMC0805X7R224K25TRPF](#) [NMC1206X7R102K50TRPF](#) [NMC-H0805X7R472K250TRPF](#) [NMC-L0402NPO7R0C50TRPF](#) [NMC-](#)  
[L0603NPO2R2B50TRPF](#) [NMC-P0805NPO221J500TRPLPF](#) [NMC-Q0402NPO8R2D200TRPF](#) [C1206C101J1GAC](#) [C1608C0G2A221J](#)  
[C1608X7R1E334K](#) [C2012C0G2A472J](#) [2220J2K00562KXT](#) [1812J2K00332KXT](#) [CDR31BX103AKWR](#) [CDR33BX104AKUR](#)  
[CDR33BX683AKUS](#) [CGA2B2C0G1H010C](#) [CGA2B2C0G1H040C](#) [CGA2B2C0G1H050C](#) [CGA2B2C0G1H060D](#) [CGA2B2C0G1H070D](#)  
[CGA2B2C0G1H120J](#) [CGA2B2C0G1H151J](#) [CGA2B2C0G1H181JT0Y0F](#) [CGA2B2C0G1H1R5C](#) [CGA2B2C0G1H2R2C](#)  
[CGA2B2C0G1H390J](#) [CGA2B2C0G1H391J](#) [CGA2B2C0G1H3R3C](#) [CGA2B2C0G1H680J](#) [CGA2B2C0G1H6R8D](#)