

Content

Low Profile Inductors

Ordering Code	2
Product Range	3
Molding Inductors (SPM Series)	4
■ Standard External Dimensions	4
■ Part Numbers & Characteristics	5
Coating Inductors (SPN/SPH Series)	15
■ Standard External Dimensions	15
■ Part Numbers & Characteristic (SPH Series for High Current)	17
Testing Condition & Requirements	37
Packaging Specification	39

Assembly Inductors

Assembly Inductors (SPI Series)	43
Product Range	43
■ Standard External Dimensions	44
■ Part Numbers & Characteristic (SPI Series)	48

Multi-Layer Chip Inductors (MLCI)

Multi-Layer Power Inductors (IP Series)	62
■ Ordering Code	62
■ Standard External Dimensions	63
■ Part Numbers & Characteristic	64
■ Testing Condition & Requirements	66
Multi-Layer High Frequency Inductors (HI Series)	68
■ Ordering Code	68
■ Standard External Dimensions	69
■ Part Numbers & Characteristic	70
■ Testing Condition & Requirements	77
Packaging Specification	80
Cautions	82

Ordering Code

SPM 2520 2R2 M P S A

Product Code:

SPM: Molding Inductor
 SPN : Coating Inductor(Normal)
 SPH :Coating Inductor(High Current)

Dimension (L X W): mm

Code	Dimension	Code	Dimension
1210	1.2 X 1.0 mm	5050	5.0 X 5.0 mm
2016	2.0 X 1.6 mm	6060	6.0 X 6.0 mm
2020	2.0 X 2.0 mm	7070	7.0 X 7.0 mm
2424	2.4 X 2.4 mm	8080	8.0 X 8.0 mm
2520	2.5 X 2.0 mm	1010	10 X 10 mm
3030	3.0 X 3.0 mm	1313	13 X 13 mm
4040	4.0 X 4.0 mm		

Inductor Value

R22=0.22 uH 2R2=2.2 uH
 220=22 uH 221=220 uH
 102=1000 uH

Tolerance Code:

M: ±20%
 T: ±25%
 N: ±30%

Packaging Code:

P: Embossed Reel (7")
 E: Embossed Reel (13")

Thickness Code:

Code	Thick	Code	Thick	Code	Thick
5	0.5	E	1.5	L	3.0
7	0.7	F	1.6	M	3.5
9	0.9	G	1.8	N	4.0
A	1.0	H	2.0	P	4.5
B	1.1	I	2.4	Q	5.0
C	1.2	J	2.5	R	6.0
D	1.4	K	2.8	S	6.5

Specification:

S:Standard
 C:High Current
 R:Low DCR
 M: Standard with vertical mark
 H:High Current with vertical mark
 T: Specific Spec

Product Range

Molding Inductors (SPM Series)

DARFON Item	Dimensions	Hieght	Inductance range				
	(mm)	(mm) max	0.1uH	1uH	10uH	100uH	1mH
SPM2016	2.5*1.6	1.0~1.2	0.47uH				2.2uH
SPM2520	2.5*2.0	1.0~1.2	0.47uH				10uH
SPM3030	3.0*3.0	1.2	0.47uH				10uH
SPM4040	4.0*4.0	1.2~2.0	0.1uH				10uH
SPM5050	5.0*5.0	1.2~2.0	0.1uH				15uH
SPM7070	7.0*7.0	1.2~5.0	0.1uH				22uH
SPM1010	10.0*10.0	4.0	0.36uH				68uH
SPM1313	13.0*13.0	3.5~6.0	0.15uH				150uH

Coating Inductors (SPN / SPH Series)

DARFON Item	Dimensions	Height	Inductance range				
	(mm)	(mm) max	0.1uH	1uH	10uH	100uH	1mH
SPH2020	2.0*2.0	1.0~1.2	0.47uH				4.7uH
SPH2520	2.5*2.0	1.0~1.2	0.47uH				22uH
SPH3030	3.0*3.0	1.0~1.2	0.47uH				22uH
SPH4040	4.0*4.0	1.0~1.8	1.0uH				33uH
SPH5050	5.0*5.0	2.0~4.0	0.47uH				47uH
SPH6060	6.0*6.0	1.2~4.5	0.8uH				100uH
SPH8080	8.0*8.0	4.0	0.9uH				22uH
SPN2016	2.0*1.6	1.0	0.47uH				10uH
SPN2020	2.0*2.0	1.2	1.0uH				4.7uH
SPN2424	2.4*2.4	1.0~1.2	0.47uH				22uH
SPN2520	2.5*2.0	1.0~1.2	0.47uH				10uH
SPN3030	3.0*3.0	1.0~1.5	1.0uH				47uH
SPN4040	4.0*4.0	1.0~1.8	1.0uH				220uH
SPN5050	5.0*5.0	1.0~4.0	0.47uH				47uH
SPN6060	6.0*6.0	1.0~4.5	0.8uH				100uH
SPN8080	8.0*8.0	3.0~4.0	0.9uH				100uH



Molding Inductors (SPM Series)



Feature

1. Magnetic shielded construction
2. Frequency range up to 3.0MHz
3. Higher rated current, capable handling at high current spikes

Application

- Notebook / Desktop applications
- VGA card applications
- DC-DC Converter applications
- Low profile, high current power supplies

Standard External Dimensions

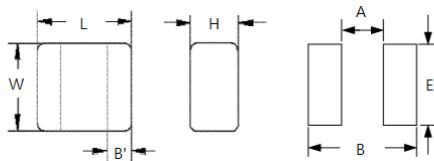

Series	L (mm)	W (mm)	H (mm)	B (mm)	Recommended Land Patterns			Package	
					A' (mm)	B (mm)	E (mm)	Reel I	Amount(pcs)
SPM2016□□□□PSA	2.0±0.2	1.6±0.2	1.0max	0.5±0.3	0.9	2.0	1.6	7"	2,000
SPM2016□□□□PSC	2.0±0.2	1.6±0.2	1.2max	0.5±0.3	0.9	2.0	1.6	7"	2,000
SPM2520□□□□PSA	2.5±0.2	2.0±0.2	1.0max	0.6±0.2	1.2	2.8	2.0	7"	2,000
SPM2520□□□□PSC	2.5±0.2	2.0±0.2	1.2max	0.6±0.2	1.2	2.8	2.0	7"	2,000

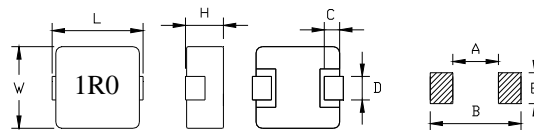

Series	L (mm)	W (mm)	H (mm)	C (mm)	D (mm)	Recommended Land Patterns			Package	
						A' (mm)	B (mm)	E (mm)	Reel I	Amount(pcs)
SPM3030□□□□PSC	3.2±0.2	3.0±0.2	1.2max	0.8±0.2	1.2±0.2	1.2	4.2	2.0	7"	2,000
SPM4040□□□□ESC	4.7±0.3	4.2±0.2	1.2max	0.8±0.3	2.0±0.3	2.4	5.4	2.5	13"	3,500
SPM4040□□□□ESH	4.7±0.3	4.2±0.2	2.0max	0.8±0.3	2.0±0.3	2.4	5.4	2.5	13"	2,000
SPM4040□□□□ECH	4.7±0.3	4.2±0.2	2.0max	0.8±0.3	2.0±0.3	2.4	5.4	2.5	13"	2,000
SPM5050□□□□ESC	5.7±0.3	5.2±0.2	1.2max	1.0±0.3	2.5±0.3	3.0	7.0	3.5	13"	3,000
SPM5050□□□□ESE	5.7±0.3	5.2±0.2	1.5max	1.0±0.3	2.5±0.3	3.0	7.0	3.5	13"	3,000
SPM5050□□□□ESH	5.7±0.3	5.2±0.2	1.8max	1.0±0.3	2.5±0.3	3.0	7.0	3.5	13"	3,000
SPM5050□□□□ECL	5.7±0.3	5.2±0.2	3.0max	1.0±0.3	2.5±0.3	3.0	7.0	3.5	13"	2,000
SPM7070□□□□ESC	7.2±0.3	6.6±0.2	1.2max	1.5±0.3	3.0±0.3	4.0	8.5	3.5	13"	2,500
SPM7070□□□□ESE	7.0±0.3	6.5±0.2	1.5max	1.5±0.3	3.0±0.3	4.0	8.5	3.5	13"	2,000
SPM7070□□□□ESG	7.2±0.3	6.6±0.2	1.8max	1.5±0.3	3.0±0.3	4.0	8.5	3.5	13"	2,000
SPM7070□□□□ESL	6.95±0.35	6.6±0.2	3.0max	1.5±0.3	3.0±0.3	4.0	8.5	3.5	13"	1,500
SPM7070□□□□ERL	6.95±0.35	6.6±0.2	3.0max	1.5±0.3	3.0±0.3	4.0	8.5	3.5	13"	1,500
SPM7070□□□□ECL	6.95±0.35	6.6±0.2	3.0max	1.5±0.3	3.0±0.3	4.0	8.5	3.5	13"	1,500
SPM7070□□□□ESQ	7.2±0.3	6.6±0.2	5.0max	1.5±0.3	3.0±0.3	4.0	8.5	3.5	13"	1,000
SPM1010□□□□ESN	11.2±0.3	10.0±0.3	4.0max	2.0±0.5	3.0±0.5	5.5	13.5	4.0	13"	800
SPM1010□□□□ECN	11.2±0.3	10.0±0.3	4.0max	2.0±0.5	3.0±0.5	5.5	13.5	4.0	13"	800
SPM1313□□□□ECM	13.9±0.3	12.8±0.2	3.5max	2.0±0.5	5.0±0.5	8.0	14.5	6.0	13"	500
SPM1313□□□□ESQ	13.9±0.3	12.8±0.2	5.0max	2.0±0.5	5.0±0.5	8.0	14.5	6.0	13"	500
SPM1313□□□□ESR	13.9±0.3	12.8±0.2	6.0max	2.0±0.5	5.0±0.5	8.0	14.5	6.0	13"	500

Part Numbers & Characteristics
SPM2016□□□□PSA (Thickness 1.0mm)

DARFON P/N	Inductance (uH)	Tolerance	DC Resistance (mΩ)		Heat Rating Current DC Amps	Saturation Current DC Amps	Measuring Condition
			Typ.	Max.	Idc(A) Typ.	Isat(A) Typ.	
SPM2016R56MPSA	0.56	± 20%	44	59	3.3	3.5	1MHz/1.0V
SPM2016R68MPSA	0.68		55	72	2.9	3.2	
SPM20161R0MPSA	1.0		80	96	2.3	2.7	
SPM20161R5MPSA	1.5		120	144	1.9	2.2	
SPM20162R2MPSA	2.2		170	204	1.4	1.9	

SPM2016□□□□PSC (Thickness 1.2mm)

DARFON P/N	Inductance (uH)	Tolerance	DC Resistance (mΩ)		Heat Rating Current DC Amps	Saturation Current DC Amps	Measuring Condition
			Typ.	Max.	Idc(A) Typ.	Isat(A) Typ.	
SPM2016R47MPSC	0.47	± 20%	40	52	3.8	4.2	1MHz/1.0V
SPM20161R0MPSC	1.0		68	82	2.7	3.1	
SPM20161R5MPSC	1.5		95	114	2.1	2.5	
SPM20162R2MPSC	2.2		160	192	1.5	2.0	

SPM2520□□□□PSA (Thickness 1.0mm)

DARFON P/N	Inductance (uH)	Tolerance	DC Resistance (mΩ)		Heat Rating Current DC Amps	Saturation Current DC Amps	Measuring Condition
			Typ.	Max.	Idc(A) Typ.	Isat(A) Typ.	
SPM2520R47MPSA	0.47	± 20%	35	46	3.6	4.4	100KHz/1.0V
SPM25201R0MPSA	1.0		45	59	3.0	3.4	
SPM25201R5MPSA	1.5		60	72	2.3	2.7	
SPM25202R2MPSA	2.2		90	108	1.8	2.4	
SPM25203R3MPSA	3.3		120	144	1.4	1.9	
SPM25204R7MPSA	4.7		200	240	1.2	1.6	

All test data are referenced to 25°C ambient.

※Isat: DC current(A) that will cause inductance to drop approximately 30%.

※Idc: DC current(A) that will cause an approximate ΔT of 40°C.

SPM2520□□□□PSC (Thickness 1.2mm)

DARFON P/N	Inductance (uH)	Tolerance	DC Resistance (mΩ)		Heat Rating Current DC Amps	Saturation Current DC Amps	Measuring Condition
			Typ.	Max.	Idc(A) Typ.	Isat(A) Typ.	
SPM2520R47MPSC	0.47	± 20%	29	35	4.0	4.1	100KHz/1.0V
SPM2520R68MPSC	0.68		38.0	45.0	3.8	3.9	
SPM25201R0MPSC	1.0		45.0	59.0	3.5	3.8	
SPM25201R5MPSC	1.5		60.0	72.0	2.8	3.3	
SPM25202R2MPSC	2.2		90.0	108.0	2.3	2.7	
SPM25203R3MPSC	3.3		120.0	144.0	1.7	2.3	
SPM25204R7MPSC	4.7		200.0	240.0	1.5	1.9	
SPM25206R0MPSC	6.0		240.0	275.0	1.3	1.7	
SPM2520100MPSC	10.0		400.0	460.0	1.0	1.3	

SPM3030□□□□PSC (Thickness 1.2mm)

DARFON P/N	Inductance (uH)	Tolerance	DC Resistance (mΩ)		Heat Rating Current DC Amps	Saturation Current DC Amps	Measuring Condition
			Typ.	Max.	Idc(A) Typ.	Isat(A) Typ.	
SPM3030R47MPSC	0.47	± 20%	21	31	4.5	6.0	100KHz/1.0V
SPM30301R0MPSC	1.0		58	65	2.8	3.4	
SPM30302R2MPSC	2.2		123	135	2.2	2.8	
SPM3030100MPSC	100		405	490	1.1	1.3	

SPM4040□□□□ESC (Thickness 1.2mm)

DARFON P/N	Inductance (uH)	Tolerance	DC Resistance (mΩ)		Heat Rating Current DC Amps	Saturation Current DC Amps	Measuring Condition
			Typ.	Max.	Idc(A) Typ.	Isat(A) Typ.	
SPM4040R47MESC	0.47	± 20%	19.0	21.0	6.0	6.8	100KHz/1.0V
SPM4040R68MESC	0.68		32.0	36.0	4.5	6.0	
SPM40401R0MESC	1.0		43.0	47.0	4.2	5.2	
SPM40401R5MESC	1.5		68.0	75.0	3.25	4.0	
SPM40402R2MESC	2.2		79.4	83.5	2.75	3.5	
SPM40403R3MESC	3.3		120.0	138.0	2.30	3.0	
SPM40404R7MESC	4.7		175.0	195.0	1.8	2.8	
SPM40406R8MESC	6.8		292.0	358.0	1.50	2.2	
SPM4040100MESC	100		394.0	465.0	1.30	1.8	

All test data are referenced to 25°C ambient.

※Isat: DC current(A) that will cause inductance to drop approximately 30%.

※Idc: DC current(A) that will cause an approximate ΔT of 40°C.



SPM4040□□□□ESH (Thickness 2.0mm)

DARFON P/N	Inductance (uH)	Tolerance	DC Resistance (mΩ)		Heat Rating Current DC Amps	Saturation Current DC Amps	Measuring Condition
			Typ.	Max.	Idc(A) Typ.	Isat(A) Typ.	
SPM4040R10NESH	0.10	± 30%	3.5	4.0	12.0	22.0	100KHz/1.0V
SPM4040R22MESH	0.22	± 20%	6.0	6.6	9.0	12.5	
SPM4040R47MESH	0.47		12.5	14.0	7.0	9.5	
SPM4040R56MESH	0.56		14.0	16.0	6.5	9.0	
SPM4040R68MESH	0.68		19.4	21.0	5.2	8.0	
SPM40401R0MESH	1.0		24.0	27.0	4.5	7.0	
SPM40401R5MESH	1.5		38.0	46.0	4.0	6.0	
SPM40402R2MESH	2.2		52.0	58.0	3.0	5.0	
SPM40403R3MESH	3.3		74.0	87.0	2.5	4.0	
SPM40404R7MESH	4.7		92.0	105.0	2.2	3.0	
SPM40406R8MESH	6.8		162.0	178.0	2.0	2.1	
SPM4040100MESH	10		256.0	282.0	1.6	1.8	

SPM4040□□□□ECH (Thickness 2.0mm)

DARFON P/N	Inductance (uH)	Tolerance	DC Resistance (mΩ)		Heat Rating Current DC Amps	Saturation Current DC Amps	Measuring Condition
			Typ.	Max.	Idc(A) Typ.	Isat(A) Typ.	
SPM4040R10NECH	0.10	± 30%	4.5	5.0	11.0	30.0	100KHz/1.0V
SPM4040R22MECH	0.22	± 20%	7.3	8.0	9.0	17.0	
SPM4040R47MECH	0.47		14.0	15.5	6.0	11.5	
SPM40401R0MECH	1.0		32.0	36.0	4.2	8.5	
SPM40402R2MECH	2.2		79.4	83.0	4.0	6.0	

SPM5050□□□□ESC (Thickness 1.2mm)

DARFON P/N	Inductance (uH)	Tolerance	DC Resistance (mΩ)		Heat Rating Current DC Amps	Saturation Current DC Amps	Measuring Condition
			Typ.	Max.	Idc(A) Typ.	Isat(A) Typ.	
SPM50501R0MESC	1.0	± 20%	31.3	32.9	5.0	6.0	100KHz/1.0V
SPM50502R2MESC	2.2		67.0	76.0	3.5	4.0	
SPM50503R3MESC	3.3		85.0	98.0	3.0	3.7	
SPM50504R7MESC	4.7		145.0	163.0	2.3	2.7	
SPM50506R8MESC	6.8		225.0	250.0	2.0	2.3	

All test data are referenced to 25°C ambient.

※Isat: DC current(A) that will cause inductance to drop approximately 30%.

(note: SPM4040□□□□ECH specification is defined inductance to drop approximately 20%)

※Idc: DC current(A) that will cause an approximate ΔT of 40°C.

SPM5050□□□□ESE (Thickness 1.5mm)

DARFON P/N	Inductance (uH)	Tolerance	DC Resistance (mΩ)		Heat Rating Current DC Amps	Saturation Current DC Amps	Measuring Condition
			Typ.	Max.	Idc(A) Typ.	Isat(A) Typ.	
SPM50501R0MESE	1.0	± 20%	20.0	23.0	6.5	9.0	100KHz/1.0V
SPM50501R2MESE	1.2		22.5	26.0	6.0	8.0	
SPM50502R2MESE	2.2		58.0	64.0	3.3	6.0	
SPM50503R3MESE	3.3		65.0	72.0	3.2	5.0	
SPM50504R7MESE	4.7		103	115	3.0	4.0	
SPM50506R8MESE	6.8		167	180	2.5	3.2	
SPM5050100MESE	10		220	246	2.0	3.0	
SPM5050150MESE	15		310.0	350.0	1.3	2.3	

SPM5050□□□□ESH (Thickness 2.0mm)

DARFON P/N	Inductance (uH)	Tolerance	DC Resistance (mΩ)		Heat Rating Current DC Amps	Saturation Current DC Amps	Measuring Condition
			Typ.	Max.	Idc(A) Typ.	Isat(A) Typ.	
SPM5050R10NESH	0.10	± 30%	7.7	9.0	10.5	15.5	100KHz/1.0V
SPM5050R22MESH	0.22	± 20%	4.1	4.5	12.0	20.0	
SPM5050R33MESH	0.33		5.5	5.9	11.5	16.0	
SPM5050R47MESH	0.47		8.0	10.0	10.5	15.5	
SPM5050R56MESH	0.56		8.2	10.0	9.5	13.0	
SPM5050R68MESH	0.68		10.5	13.0	9.0	12.0	
SPM50501R0MESH	1.0		15.0	17.0	8.0	9.5	
SPM50501R5MESH	1.5		21.0	24.2	6.0	9.0	
SPM50502R2MESH	2.2		30.0	35.0	5.0	6.5	
SPM50503R3MESH	3.3		52.0	58.0	4.5	5.5	
SPM50504R7MESH	4.7		78.0	85.0	3.5	4.0	
SPM50505R6MESH	5.6		85.2	92.0	3.0	2.2	
SPM50506R8MESH	6.8		107.0	120.0	2.8	3.6	
SPM5050100MESH	10		140.0	155.0	2.4	3.4	

All test data are referenced to 25°C ambient.

※Isat: DC current(A) that will cause inductance to drop approximately 30%.

※Idc: DC current(A) that will cause an approximate ΔT of 40°C.



SPM5050□□□□ECL (Thickness 3.0mm)

DARFON P/N	Inductance (uH)	Tolerance	DC Resistance (mΩ)		Heat Rating Current DC Amps	Saturation Current DC Amps	Measuring Condition
			Typ.	Max.	Idc(A) Typ.	Isat(A) Typ.	
SPM5050R68MECL	0.68	± 20%	11.0	12.0	8.5	14.0	100KHz/1.0V
SPM50501R0MECL	1.0		13.0	14.0	7.0	11.0	
SPM50501R2MECL	1.2		15.0	16.0	6.5	11.0	
SPM50501R5MECL	1.5		20.0	25.0	6.0	10.0	
SPM50502R2MECL	2.2		29.0	35.0	5.5	9.0	
SPM50503R3MECL	3.3		32.0	38.0	5.0	7.0	
SPM50504R7MECL	4.7		50.0	60.0	4.4	6.0	

SPM7070□□□□ESC (Thickness 1.2mm)

DARFON P/N	Inductance (uH)	Tolerance	DC Resistance (mΩ)		Heat Rating Current DC Amps	Saturation Current DC Amps	Measuring Condition
			Typ.	Max.	Idc(A) Typ.	Isat(A) Typ.	
SPM7070R56MESC	0.56	± 20%	13.5	15.5	7.0	11.0	100KHz/1.0V
SPM7070R68MESC	0.68		15.0	17.5	6.7	9.0	
SPM7070R82MESC	0.82		21.5	24.5	6.3	8.0	
SPM70701R0MESC	1.0		25.0	29.0	6.0	7.0	
SPM70702R2MESC	2.2		51.5	59.0	4.0	5.0	
SPM70703R3MESC	3.3		80.0	92.0	3.0	4.0	
SPM70704R7MESC	4.7		106.0	122.0	2.7	3.5	
SPM70706R8MESC	6.8		185.0	217.0	2.2	2.4	
SPM7070100MESC	10		250.0	290.0	2.0	2.2	

SPM7070□□□□ESE (Thickness 1.5mm)

DARFON P/N	Inductance (uH)	Tolerance	DC Resistance (mΩ)		Heat Rating Current DC Amps	Saturation Current DC Amps	Measuring Condition
			Typ.	Max.	Idc(A) Typ.	Isat(A) Typ.	
SPM7070R33MESE	0.33	± 20%	6.8	7.8	10.0	19.5	100KHz/1.0V
SPM7070R56MESE	0.56		9.5	11.0	9.0	14.0	
SPM7070R68MESE	0.68		10.5	12.0	8.5	12.0	
SPM7070R82MESE	0.82		15.0	17.0	7.0	10.0	
SPM70701R0MESE	1.0		18.5	21.0	5.5	9.0	
SPM70701R5MESE	1.5		37.0	42.5	5.0	7.0	
SPM70702R2MESE	2.2		46.0	54.0	3.5	6.0	
SPM70703R3MESE	3.3		54.0	63.0	3.3	5.5	
SPM70704R7MESE	4.7		76.0	85.0	3.0	5.0	
SPM70705R6MESE	5.6		96.0	118.0	2.8	4.5	
SPM70706R8MESE	6.8		125.0	135.0	2.5	4.0	
SPM7070100MESE	10		165.0	175.0	2.0	3.0	

All test data are referenced to 25°C ambient.

※Isat: DC current(A) that will cause inductance to drop approximately 30%.

(note: SPM5050□□□□ECL specification is defined inductance to drop approximately 20%)

※Idc: DC current(A) that will cause an approximate ΔT of 40°C.

SPM7070□□□□ESG (Thickness 1.8mm)

DARFON P/N	Inductance (uH)	Tolerance	DC Resistance (mΩ)		Heat Rating Current DC Amps	Saturation Current DC Amps	Measuring Condition
			Typ.	Max.			
SPM7070R33MESG	0.33	± 20%	5.2	6.8	12.0	22.0	100KHz/1.0V
SPM7070R47MESG	0.47		7.3	8.4	11.0	17.0	
SPM7070R68MESG	0.68		10.8	12.7	9.0	16.0	
SPM7070R82MESG	0.82		13.4	15.9	8.0	14.0	
SPM70701R0MESG	1.0		14.5	17.0	7.0	12.0	
SPM70702R2MESG	2.2		31.0	35.0	5.0	8.0	
SPM70703R3MESG	3.3		56.0	60.0	3.5	7.0	
SPM70704R7MESG	4.7		68.0	70.0	3.2	5.5	
SPM70706R8MESG	6.8		101.0	110.0	2.8	4.5	
SPM70708R2MESG	8.2		124.0	142.0	2.5	4.0	
SPM7070100MESG	10		155.0	166.0	2.0	3.0	

SPM7070□□□□ESL (Thickness 3.0mm)

DARFON P/N	Inductance (uH)	Tolerance	DC Resistance (mΩ)		Heat Rating Current DC Amps	Saturation Current DC Amps	Measuring Condition
			Typ.	Max.			
SPM7070R10NESL	0.10	± 30%	1.5	1.7	32.5	60.0	100KHz/1.0V
SPM7070R22MESL	0.22	± 20%	2.5	2.8	23.0	34.0	
SPM7070R33MESL	0.33		3.0	3.5	21.0	25.0	
SPM7070R47MESL	0.47		3.5	4.1	18.0	20.0	
SPM7070R56MESL	0.56		3.9	4.5	16.5	18.0	
SPM7070R68MESL	0.68		4.5	5.0	16.0	17.0	
SPM7070R82MESL	0.82		7.0	7.5	14.0	16.0	
SPM70701R0MESL	1.0		8.5	9.0	12.0	15.0	
SPM70701R5MESL	1.5		10.6	12.1	10.0	13.0	
SPM70702R2MESL	2.2		15.5	18.0	8.0	10.0	
SPM70702R5MESL	2.5		18.0	20.0	7.0	10.0	
SPM70703R3MESL	3.3		25.0	28.0	6.5	9.0	
SPM70704R7MESL	4.7		32.5	35.0	5.5	6.5	
SPM70705R6MESL	5.6		36.0	42.0	5.0	6.3	
SPM70706R8MESL	6.8		43.9	50.0	4.5	6.0	
SPM70708R2MESL	8.2		54.0	60.0	4.5	6.0	
SPM7070100MESL	10		62.0	68.0	4.0	5.5	
SPM7070220MESL	22		144.0	160.0	2.5	3.0	

All test data are referenced to 25°C ambient.

※Isat: DC current(A) that will cause inductance to drop approximately 30%.

※Idc: DC current(A) that will cause an approximate ΔT of 40°C.

SPM7070□□□□ERL (Thickness 3.0mm)

DARFON P/N	Inductance (uH)	Tolerance	DC Resistance (mΩ)		Heat Rating Current DC Amps	Saturation Current DC Amps	Measuring Condition
			Typ.	Max.	Idc(A) Typ.	Isat(A) Typ.	
SPM7070R82MERL	0.82	± 20%	5.2	6.0	16.0	16.0	100KHz/1.0V
SPM70701R0MERL	1.0		5.5	6.6	15.0	15.0	
SPM70701R5MERL	1.5		7.7	9.3	12.5	14.5	
SPM70702R2MERL	2.2		12.0	13.8	10.0	14.0	
SPM70703R3MERL	3.3		19.6	22.5	7.7	10.0	

SPM7070□□□□ECL (Thickness 3.0mm)

DARFON P/N	Inductance (uH)	Tolerance	DC Resistance (mΩ)		Heat Rating Current DC Amps	Saturation Current DC Amps	Measuring Condition
			Typ.	Max.	Idc(A) Typ.	Isat(A) Typ.	
SPM7070R10NECL	0.10	± 30%	1.5	1.7	32.5	60.0	100KHz/1.0V
SPM7070R22MECL	0.22	± 20%	2.5	2.8	23.0	40.0	
SPM7070R33MECL	0.33		3.5	3.9	20.0	30.0	
SPM7070R47MECL	0.47		4.0	4.2	17.5	26.0	
SPM7070R56MECL	0.56		4.7	5.0	16.5	25.5	
SPM7070R68MECL	0.68		5.0	5.5	15.5	25.0	
SPM7070R82MECL	0.82		6.7	8.0	13.0	24.0	
SPM70701R0MECL	1.0		9.0	10.0	11.0	22.0	
SPM70701R5MECL	1.5		14.0	15.0	9.0	18.0	
SPM70702R2MECL	2.2		18.0	20.0	8.0	14.0	
SPM70702R5MECL	2.5		20.0	22.0	7.0	14.0	
SPM70703R3MECL	3.3		28.0	30.0	6.0	13.5	
SPM70704R7MECL	4.7		37.0	40.0	5.5	10.0	
SPM70706R8MECL	6.8		54.0	60.0	4.5	8.0	
SPM70708R2MECL	8.2		64.0	68.0	4.0	7.5	
SPM7070100MECL	10		102.0	105.0	3.0	7.0	

All test data are referenced to 25°C ambient.

※Isat: DC current(A) that will cause inductance to drop approximately 30%.

(note: SPM7070□□□□ECL specification is defined inductance to drop approximately 20%)

※Idc: DC current(A) that will cause an approximate ΔT of 40°C.



SPM7070□□□□ESQ (Thickness 5.0mm)

DARFON P/N	Inductance (uH)	Tolerance	DC Resistance (mΩ)		Heat Rating Current DC Amps	Saturation Current DC Amps	Measuring Condition
			Typ.	Max.	Idc(A) Typ.	Isat(A) Typ.	
SPM7070R22MESQ	0.22	± 20%	1.1	1.3	30.0	35.0	
SPM7070R36MESQ	0.36		2.7	3.1	21.0	25.0	
SPM7070R56MESQ	0.56		3.4	3.6	20.0	18.0	
SPM7070R68MESQ	0.68		3.3	3.6	18.0	17.0	
SPM7070R82MESQ	0.82		4.6	4.9	16.5	17.0	
SPM70701R0MESQ	1.0		4.5	5.3	14.5	16.0	
SPM70701R5MESQ	1.5		6.0	7.5	11.5	15.0	
SPM70702R2MESQ	2.2		9.0	10.2	10.5	13.5	
SPM70703R3MESQ	3.3		14.0	15	9.0	12.0	
SPM70704R7MESQ	4.7		23.0	25.0	6.5	8.0	
SPM70705R6MESQ	5.6		31.5	34.4	6.0	7.0	
SPM70706R8MESQ	6.8		31	35.5	5.5	6.5	
SPM70708R2MESQ	8.2		40.0	43.0	5.0	5.5	
SPM7070100MESQ	10		48.0	55.0	4.5	5.0	

SPM1010□□□□ESN (Thickness 4.0mm)

DARFON P/N	Inductance (uH)	Tolerance	DC Resistance (mΩ)		Heat Rating Current DC Amps	Saturation Current DC Amps	Measuring Condition
			Typ.	Max.	Idc(A) Typ.	Isat(A) Typ.	
SPM1010R45MESN	0.45	1.1	1.3	29.0	40.0		
SPM1010R56MESN	0.56	1.6	1.8	25.0	33.0		
SPM10101R0MESN	1.0	3.0	3.3	18.0	28.0		
SPM10101R5MESN	1.5	3.8	4.2	16.0	24.0		
SPM10102R0MESN	2.0	5.2	5.8	14.0	20.0		
SPM10102R2MESN	2.2	6.0	7.0	12.0	18.0		
SPM10103R3MESN	3.3	10.8	11.8	10.0	16.0		
SPM10104R7MESN	4.7	17.0	20.0	8.5	15.0		
SPM10105R6MESN	5.6	20.0	23.0	8.0	14.0		
SPM10106R8MESN	6.8	22.5	25.0	7.0	12.0		
SPM10108R2MESN	8.2	25.0	27.0	6.5	9.0		
SPM1010100MESN	10	27.0	30.0	6.5	8.5		
SPM1010150MESN	15	40.0	45.0	6.3	7.0		
SPM1010220MESN	22	60.0	66.0	5.0	5.5		
SPM1010330MESN	33	85.0	92.0	4.0	4.5		
SPM1010470MESN	47	130.0	145.0	3.3	3.5		
SPM1010680MESN	68	178.0	195.0	2.3	3.0		

All test data are referenced to 25°C ambient.

※Isat: DC current(A) that will cause inductance to drop approximately 30%.

※Idc: DC current(A) that will cause an approximate ΔT of 40°C.



SPM1010□□□□ECN (Thickness 4.0mm)

DARFON P/N	Inductance (uH)	Tolerance	DC Resistance (mΩ)		Heat Rating Current DC Amps	Saturation Current DC Amps	Measuring Condition
			Typ.	Max.	Idc(A) Typ.	Isat(A) Typ.	
SPM1010R36MECN	0.36	± 20%	1.1	1.3	30.0	60.0	100KHz/1.0V
SPM1010R39MECN	0.39		1.1	1.3	30.0	60.0	
SPM1010R45MECN	0.45		1.1	1.3	29.0	45.0	
SPM1010R68MECN	0.68		2.4	2.7	22.0	39.0	
SPM1010R88MECN	0.88		2.7	3.0	20.0	38.0	
SPM10101R5MECN	1.5		3.8	4.2	16.0	33.0	
SPM10102R2MECN	2.2		6.7	7.0	12.0	27.0	
SPM10103R3MECN	3.3		10.8	11.8	10.0	18.7	
SPM10104R7MECN	4.7		15.0	16.5	9.5	17.0	

SPM1313□□□□ECM (Thickness 3.5mm)

DARFON P/N	Inductance (uH)	Tolerance	DC Resistance (mΩ)		Heat Rating Current DC Amps	Saturation Current DC Amps	Measuring Condition
			Typ.	Max.	Idc(A) Typ.	Isat(A) Typ.	
SPM1313R22MECM	0.22	± 20%	1.1	1.3	38.0	65.0	100KHz/1.0V
SPM1313R33MECM	0.33		1.3	1.5	36.5	62.0	
SPM1313R47MECM	0.47		1.7	2.0	32.0	55.0	
SPM1313R56MECM	0.56		1.8	2.2	29.0	51.0	
SPM1313R68MECM	0.68		2.3	2.5	28.0	49.0	
SPM13131R0MECM	1.0		3.3	3.5	24.0	40.0	
SPM13131R5MECM	1.5		5.1	5.5	19.0	35.0	
SPM13132R2MECM	2.2		7.2	8.0	16.0	29.0	
SPM13133R3MECM	3.3		10.0	12.0	12.0	27.0	
SPM13134R7MECM	4.7		16.0	18.0	9.0	22.0	

All test data are referenced to 25°C ambient.

※Isat: DC current(A) that will cause inductance to drop approximately 30%.

(note: SPM1010□□□□ECN and SPM1313□□□□ECM specifications are defined inductance to drop approximately 20%)

※Idc: DC current(A) that will cause an approximate ΔT of 40°C.



SPM1313□□□□ESQ (Thickness 5.0mm)

DARFON P/N	Inductance (uH)	Tolerance	DC Resistance (mΩ)		Heat Rating Current DC Amps	Saturation Current DC Amps	Measuring Condition
			Typ.	Max.	Idc(A) Typ.	Isat(A) Typ.	
SPM1313R15MESQ	0.15	± 20%	0.38	0.45	45.0	60.0	100KHz/1.0V
SPM1313R36MESQ	0.36		0.64	0.95	41.0	55.0	
SPM1313R47MESQ	0.47		0.85	1.1	38.0	50.0	
SPM1313R56MESQ	0.56		1.1	1.3	36.0	45.0	
SPM1313R68MESQ	0.68		1.2	1.5	34.0	40.0	
SPM1313R82MESQ	0.82		1.5	1.7	31.0	34.0	
SPM13131R0MESQ	1.0		1.9	2.2	26.0	30.0	
SPM13131R5MESQ	1.5		2.8	3.2	23.0	27.0	
SPM13132R2MESQ	2.2		4.0	5.0	15.0	24.0	
SPM13133R3MESQ	3.3		5.9	7.0	14.0	22.0	
SPM1313100MESQ	10		19.0	22.0	9.0	12.0	
SPM1313220MESQ	22		51.0	58.0	4.5	6.5	
SPM1313270MESQ	27		58.0	66.0	4.0	6.3	
SPM1313330MESQ	33		75.0	84.0	3.5	6.0	
SPM1313470MESQ	47		116.0	130.0	3.0	5.0	

SPM1313□□□□ESR (Thickness 6.0mm)

DARFON P/N	Inductance (uH)	Tolerance	DC Resistance (mΩ)		Heat Rating Current DC Amps	Saturation Current DC Amps	Measuring Condition
			Typ.	Max.	Idc(A) Typ.	Isat(A) Typ.	
SPM1313R22MESR	0.22	± 20%	0.50	0.60	36.00	70.00	100KHz/1.0V
SPM1313R33MESR	0.33		0.60	0.80	35.00	65.00	
SPM1313R47MESR	0.47		0.7	0.9	34	60.00	
SPM1313R68MESR	0.68		1.00	1.20	32.00	45.00	
SPM13131R0MESR	1.00		1.60	1.90	31.00	43.00	
SPM13132R2MESR	2.20		3.30	4.10	21.00	30.00	
SPM13133R3MESR	3.30		5.30	6.40	17.00	22.00	
SPM13134R7MESR	4.7		7.2	9.0	16.00	18.0	
SPM13136R8MESR	6.8		9.5	12.0	12.0	15.0	
SPM13138R2MESR	8.2		13.6	16.0	11.0	13.5	
SPM1313100MESR	10		18.0	20.7	10.0	12.5	
SPM1313120MESR	12		20.0	23.0	7.0	10.0	
SPM1313150MESR	15		25.0	29.0	6.0	9.0	
SPM1313220MESR	22		34.0	39.5	5.0	7.5	
SPM1313270MESR	27		49.0	56.0	4.5	6.5	
SPM1313330MESR	33		65.0	75.0	4.0	6.0	
SPM1313470MESR	47		80.0	90.0	3.5	5.5	
SPM1313680MESR	68		120.0	140.0	3.0	4.5	
SPM1313101MESR	100		180.0	200.0	2.5	3.5	
SPM1313121MESR	120	210.0	235.0	2.3	3.2		
SPM1313151MESR	150	300.0	350.0	2.0	2.7		

All test data are referenced to 25°C ambient.

※Isat: DC current(A) that will cause inductance to drop approximately 30%.

※Idc: DC current(A) that will cause an approximate ΔT of 40°C.



Coating Inductors (SPN/SPH Series)



Feature

1. Small and low profile inductor
2. It corresponds to high current
3. Simple and original magnetic shield structure

Application

For small DC/DC converter (HDD, DVC, DSC, LCD display, notebook, tablet, Bluetooth earphone, cellular phones)

Standard External Dimensions

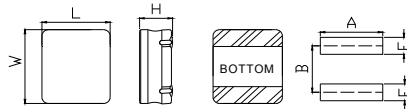

Series	L (mm)	W (mm)	H (mm)	Recommended Land Patterns			Package	
				A (mm)	B (mm)	E (mm)	Reel	Amount(pcs)
SPN2016□□□□PSA	2.0±0.2	1.6±0.2	1.0max	1.7	2.3	0.6	7"	2,000
SPN2520□□□□PSA	2.5±0.2	2.0±0.2	1.0max	2.1	0.8	0.85	7"	2,000
SPH2520□□□□PSA	2.5±0.3	2.0±0.3	1.0±0.1	2.1	0.8	0.85	7"	2,000
SPN2520□□□□PSC	2.5±0.2	2.0±0.2	1.2max	2.1	0.8	0.85	7"	2,000
SPH2520□□□□PSC	2.5±0.3	2.0±0.3	1.2±0.1	2.1	0.8	0.85	7"	2,000

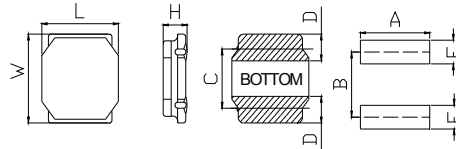

Seri	L (mm)	W (mm)	H (mm)	C (mm)	D (mm)	Recommended Land Patterns			Package	
						A (mm)	B (mm)	E (mm)	Reel	Amount(pcs)
SPN2020□□□□PTC	2.0±0.1	2.0±0.1	1.2max	1.25±0.2	0.5±0.2	2.0	1.35	0.65	7"	2,500
SPH2020□□□□PCC	2.0±0.1	2.0±0.1	1.2max	1.25±0.2	0.5±0.2	2.0	1.35	0.65	7"	2,500
SPH2020□□□□PTA	2.0±0.1	2.0±0.1	1.0max	1.25±0.2	0.5±0.2	2.0	1.35	0.65	7"	2,500
SPH2020□□□□PTC	2.0±0.1	2.0±0.1	1.2max	1.25±0.2	0.5±0.2	2.0	1.35	0.65	7"	2,500
SPN2424□□□□PTA	2.4±0.1	2.4±0.1	1.0max	1.45±0.2	0.6±0.2	2.0	1.45	0.7	7"	2,500
SPN2424□□□□PTC	2.4±0.1	2.4±0.1	1.2max	1.45±0.2	0.6±0.2	2.0	1.45	0.7	7"	2,500
SPN3030□□□□PTA	3.0±0.1	3.0±0.1	1.0max	1.9±0.2	0.9±0.2	2.7	2.2	0.8	7"	2,000
SPH3030□□□□PTA	3.0±0.1	3.0±0.1	1.0max	1.9±0.2	0.9±0.2	2.7	2.2	0.	7"	2,000
SPN3030□□□□PTC	3.0±0.1	3.0±0.1	1.2max	1.9±0.2	0.9±0.2	2.7	2.2	0.8	7"	2,000
SPH3030□□□□PTC	3.0±0.1	3.0±0.1	1.2max	1.9±0.2	0.9±0.2	2.7	2.2	0.8	7"	2,000
SPN3030□□□□PTE	3.0±0.1	3.0±0.1	1.5max	1.9±0.2	0.9±0.2	2.7	2.2	0.8	7"	2,000
SPN4040□□□□ETA	4.0±0.2	4.0±0.2	1.0max	2.5±0.2	1.1±0.2	3.7	2.8	1.2	13"	5,000
SPH4040□□□□ETA	4.0±0.2	4.0±0.2	1.0max	2.5±0.2	1.1±0.2	3.7	2.8	1.2	13"	5,000
SPN4040□□□□ETC	4.0±0.2	4.0±0.2	1.2max	2.5±0.2	1.1±.2	3.7	2.8	1.2	13"	4,500
SPH4040□□□□ETC	4.0±0.2	4.0±0.2	1.2max	2.5±0.2	1.1±0.2	3.7	2.8	1.2	13"	4,500
SPN4040□□□□ETG	4.0±0.2	4.0±0.2	1.8max	2.5±0.2	1.1±0.2	3.7	2.8	1.2	13"	3,500
SPH4040□□□□ETG	4.0±0.2	4.0±0.2	1.8max	2.5±0.2	1.1±0.2	3.7	2.8	1.2	13"	3,500
SPN5050□□□□PTA	4.9±0.1	4.9±0.1	1.0max	3.3±0.2	1.4±0.2	4.0	3.6	1.5	"	1,000
SPN5050□□□□PTC	4.9±0.1	4.9±0.1	1.2max	3.3±0.2	1.4±0.2	4.0	3.6	1.5	7"	1,000
SPN5050□□□□PTD	4.9±0.1	4.9±0.1	1.4max	3.3±0.2	1.4±0.2	4.0	3.6	1.5	7"	1,000
SPH5050□□□□PTH	4.9±0.1	4.9±0.1	2.0max	3.3±0.2	1.4±0.2	4.0	3.6	1.5	7"	800
SPN5050□□□□ETI	4.9±0.1	4.9±0.1	2.4max	3.3±0.2	1.4±0.2	4.0	3.6	1.5	13"	2,500
SPN5050□□□□ETL	4.9±0.2	4.9±0.2	3.0max	3.3±0.2	1.2±0.2	4.0	3.6	1.5	7"	500
SPN5050□□□□ETN	4.9±0.1	4.9±0.1	4.0max	3.3±0.2	1.4±0.2	4.0	3.6	1.5	13"	1,500
SPH5050□□□□ETN	4.9±0.1	4.9±0.1	4.0max	3.3±0.2	1.4±0.2	4.0	3.6	1.5	13"	1,500

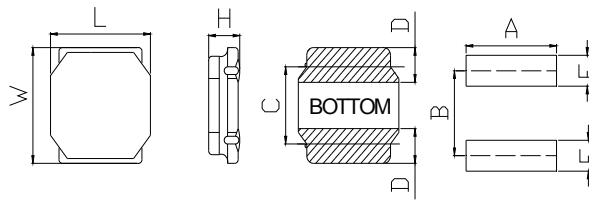

Series	L (mm)	W (mm)	H (mm)	C (mm)	D (mm)	Recommended Land Patterns			Package	
						A (mm)	B (mm)	E (mm)	Reel	Amount(pcs)
SPN6060□□□□PTA	6.0±0.2	6.0±0.2	1.0max	4.0±0.2	1.65±0.2	5.7	4.7	1.6	7"	1,000
SPN6060□□□□PTC	6.0±0.2	6.0±0.2	1.2max	4.0±0.2	1.65±0.2	5.7	4.7	1.6	7"	1,000
SPH6060□□□□PTC	6.0±0.2	6.0±0.2	1.2max	4.0±0.2	1.65±0.2	5.7	4.7	1.6	7"	1,000
SPN6060□□□□PTD	6.0±0.2	6.0±0.2	1.4max	4.0±0.2	1.65±0.2	5.7	4.7	1.6	7"	1,000
SPN6060□□□□ETH	6.0±0.2	6.0±0.2	2.0max	4.0±0.2	1.65±0.2	5.7	4.7	1.6	13"	2,500
SPH6060□□□□ETH	6.0±0.2	6.0±0.2	2.0max	4.0±0.2	1.65±0.2	5.7	4.7	1.6	13"	2,500
SPN6060□□□□ETK	6.0±0.2	6.0±0.2	2.8max	4.0±0.2	1.65±0.2	5.7	4.7	1.6	13"	2,000
SPH6060□□□□ETK	6.0±0.2	6.0±0.2	2.8max	4.0±0.2	1.65±0.2	5.7	4.7	1.6	13"	2,000
SPN6060□□□□ETP	6.0±0.2	6.0±0.2	4.5max	4.0±0.2	1.65±0.2	5.7	4.7	1.6	13"	1,500
SPH6060□□□□ETP	6.0±0.2	6.0±0.2	4.5max	4.0±0.2	1.65±0.2	5.7	4.7	1.6	13"	1,500
SPN8080□□□□ETL	8.0±0.2	8.0±0.2	3.0max	5.6±0.3	1.6±0.3	7.5	5.6	1.8	13"	1,000
SPN8080□□□□ETN	8.0±0.2	8.0±0.2	4.0max	5.6±0.3	1.6±0.3	7.5	5.6	1.8	13"	1,000
SPH8080□□□□ETN	8.0±0.2	8.0±0.2	4.0max	5.6±0.3	1.6±0.3	7.5	5.6	1.8	13"	1,000

Part Numbers & Characteristic (SPH Series for High Current)
SPH2020□□□□PSA (Thickness 1.0mm)

DARFON P/N	Inductance (uH)	Tolerance	DC Resistance (mΩ)		Heat Rating Current DC Amp.	Saturation Current DC Amps.	Measuring Condition
			Typ.	Max.	Idc(A) Max.	Isat(A) Max.	
SPH2020R47NPTA	0.47	± 30%	52	62	2.00	2.10	100KHz, 1V
SPH2020R68NPTA	0.68		60	72	1.85	1.85	
SPH20201R0NPTA	1.0		80	96	1.60	1.55	
SPH20201R5MPTA	1.5	± 20%	100	120	1.45	1.35	
SPH20202R2MPTA	2.2		175	210	1.10	1.10	
SPH20203R3MPTA	3.3		250	300	1.00	0.88	
SPH20204R7MPTA	4.7		320	384	0.82	0.76	

SPH2020□□□□PCC (Thickness 1.2mm)

DARFON P/N	Inductance (uH)	Tolerance	DC Resistance (mΩ)		Heat Rating Current DC Amp.	Saturation Current DC Amps.	Measuring Condition
			Typ.	Max.	Idc(A) Max.	Isat(A) Max.	
SPH2020R47MPCC	0.47	± 20%	40	46	2.30	4.20	1MHz, 1V
SPH2020R68MPCC	0.68		50	58	2.00	3.50	
SPH20201R0MPCC	1.0		56	64	1.90	2.55	
SPH20201R5MPCC	1.5		75	86	1.65	2.00	
SPH20202R2MPCC	2.2		95	109	1.45	1.75	
SPH20203R3MPCC	3.3		155	178	1.15	1.35	
SPH20204R7MPCC	4.7		210	242	0.95	1.15	

SPH2020□□□□PTC (Thickness 1.2mm)

DARFON P/N	Inductance (uH)	Tolerance	DC Resistance (mΩ)		Heat Rating Current DC Amp.	Saturation Current DC Amps.	Measuring Condition
			Typ.	Max.	Idc(A) Max.	Isat(A) Max.	
SPH20201R0NPTC	1.0	± 30%	73	88	1.65	2.20	100KHz, 1V
SPH20201R5NPTC	1.5		100	120	1.40	1.80	
SPH20202R2MPTC	2.2	± 20%	129	155	1.20	1.60	
SPH20203R3MPTC	3.3		227	272	0.90	1.25	
SPH20204R7MPTC	4.7		325	390	0.75	1.10	

※Isat :DC current(A) that will cause inductance to drop approximately 30%

※Idc: DC current(A) that will cause an approximate ΔT of 20°C (at 25°C ambient)



SPH2520□□□□PSA (Thickness 1.0mm)

DARFON P/N	Inductance (uH)	Tolerance	DC Resistance (mΩ)		Heat Rating Current DC Amp.	Saturation Current DC Amps.	Measuring Condition
			Typ.	Max.	Idc(A) Typ.	Isat(A) Max.	
SPH2520R50NPSA	0.50	± 30%	32	38	2.67	3.00	1MHz,1V
SPH2520R68NPSA	0.68		49	59	2.40	2.43	
SPH25201R0NPSA	1.0		68	82	1.98	2.20	
SPH25201R5MPSA	1.5	± 20%	95	114	1.65	1.58	
SPH25202R2MPSA	2.2		136	163	1.40	1.39	
SPH25203R3MPSA	3.3		207	248	1.15	1.17	
SPH25204R7MPSA	4.7		269	323	0.99	1.08	
SPH25206R8MPSA	6.8		404	485	0.81	0.77	
SPH2520100MPSA	10		508	610	0.72	0.65	

SPH2520□□□□PSC (Thickness 1.2mm)

DARFON P/N	Inductance (uH)	Tolerance	DC Resistance (mΩ)		Heat Rating Current DC Amp.	Saturation Current DC Amps.	Measuring Condition
			Typ.	Max.	Idc(A) Typ.	Isat(A) Max.	
SPH2520R47NPSC	0.47	± 30%	29	35	3.70	3.50	1MHz,1V
SPH2520R50NPSC	0.50		32	38	3.60	3.40	
SPH25201R0NPSC	1.0		43	52	2.60	2.45	
SPH25201R5MPSC	1.5	± 20%	72	86	2.20	2.07	
SPH25202R2MPSC	2.2		90	108	1.85	1.95	
SPH25203R3MPSC	3.3		155	186	1.45	1.60	
SPH25204R7MPSC	4.7		212	254	1.20	1.40	
SPH25206R8MPSC	6.8		370	444	1.00	1.04	
SPH2520100MPSC	10		750	900	0.75	0.77	
SPH2520220MPSC	22		1050	1260	0.50	0.50	

※Isat :DC current(A) that will cause inductance to drop approximately 30%

※Idc: DC current(A) that will cause an approximate ΔT of 20°C (at 25°C ambient)

(note: SPH2520□□□□PSA SPH2520□□□□PSC specifications are defined an approximately ΔT of 40°C)



SPH3030□□□□PTA (Thickness 1.0mm)

DARFON P/N	Inductance (uH)	Tolerance	DC Resistance (mΩ)		Heat Rating Current DC Amp.	Saturation Current DC Amps.	Measuring Condition
			Typ.	Max.	Idc(A) Max.	Isat(A) Max.	
SPH30301R2NPTA	1.2	± 30%	65	78	1.48	1.70	100KHz, 1V
SPH30301R5NPTA	1.5		75	90	1.37	1.44	
SPH30302R2MPTA	2.2	± 20%	83	100	1.30	1.30	
SPH30303R3MPTA	3.3		130	156	1.03	1.00	
SPH30304R7MPTA	4.7		170	204	0.90	0.85	
SPH30306R8MPTA	6.8		250	300	0.74	0.70	
SPH3030100MPTA	10		350	420	0.62	0.60	
SPH3030150MPTA	15		550	660	0.48	0.45	
SPH3030220MPTA	22		770	924	0.41	0.38	

SPH3030□□□□PTC (Thickness 1.2mm)

DARFON P/N	Inductance (uH)	Tolerance	DC Resistance (mΩ)		Heat Rating Current DC Amp.	Saturation Current DC Amps.	Measuring Condition
			Typ.	Max.	Idc(A) Max.	Isat(A) Max.	
SPH3030R47NPTC	0.47	± 30%	33	40	1.90	2.60	100KHz, 1V
SPH30301R0NPTC	1.0		48	58	1.71	2.20	
SPH30301R5NPTC	1.5		55	66	1.60	1.70	
SPH30302R2MPTC	2.2	± 20%	75	90	1.37	1.50	
SPH30303R3MPTC	3.3		100	120	1.21	1.20	
SPH30304R7MPTC	4.7		130	156	1.06	1.00	
SPH30306R8MPTC	6.8		190	228	0.89	0.85	
SPH3030100MPTC	10		270	324	0.72	0.73	
SPH3030150MPTC	15		450	540	0.57	0.53	
SPH3030220MPTC	22		630	756	0.50	0.50	

※Isat :DC current(A) that will cause inductance to drop approximately 30%

※Idc: DC current(A) that will cause an approximate ΔT of 20°C (at 25°C ambient)



SPH4040□□□□ETA (Thickness 1.0mm)

DARFON P/N	Inductance (uH)	Tolerance	DC Resistance (mΩ)		Heat Rating Current DC Amp.	Saturation Current DC Amps.	Measuring Condition
			Typ.	Max.	Idc(A) Max.	Isat(A) Max.	
SPH40401R0NETA	1.0	± 30%	56	67	1.90	2.00	100KHz, 1V
SPH40402R2META	2.2	± 20%	85	102	1.50	1.20	
SPH40403R3META	3.3		100	120	1.40	1.10	
SPH40404R7META	4.7		140	168	1.20	0.95	
SPH40406R8META	6.8		200	240	1.00	0.80	
SPH4040100META	10		300	360	0.75	0.62	
SPH4040150META	15		430	516	0.60	0.54	
SPH4040220META	22		570	684	0.50	0.45	

SPH4040□□□□ETC (Thickness 1.2mm)

DARFON P/N	Inductance (uH)	Tolerance	DC Resistance (mΩ)		Heat Rating Current DC Amp.	Saturation Current DC Amps.	Measuring Condition
			Typ.	Max.	Idc(A) Max.	Isat(A) Max.	
SPH40401R0NETC	1.0	± 30%	42	50	2.200	2.800	100KHz, 1V
SPH40402R2METC	2.2	± 20%	60	72	1.900	1.650	
SPH40403R3METC	3.3		70	84	1.700	1.400	
SPH40404R7METC	4.7		95	114	1.500	1.200	
SPH40406R8METC	6.8		125	150	1.300	0.900	
SPH4040100METC	10		170	204	1.100	0.800	
SPH4040150METC	15		260	312	0.750	0.650	
SPH4040220METC	22		400	480	0.620	0.500	

SPH4040□□□□ETG (Thickness 1.8mm)

DARFON P/N	Inductance (uH)	Tolerance	DC Resistance (mΩ)		Heat Rating Current DC Amp.	Saturation Current DC Amps.	Measuring Condition
			Typ.	Max.	Idc(A) Max.	Isat(A) Max.	
SPH40401R0NETG	1.0	± 30%	27	32	3.20	4.00	100KHz, 1V
SPH40401R5NESG	1.5	± 20%	40	48	2.64	3.30	
SPH40402R2METG	2.2		42	50	2.20	3.00	
SPH40403R3METG	3.3		55	66	2.00	2.30	
SPH40404R7METG	4.7		70	84	1.70	2.00	
SPH40406R8METG	6.8		98	118	1.45	1.60	
SPH4040100METG	10		150	180	1.20	1.30	
SPH4040150METG	15		210	252	0.85	1.10	
SPH4040220METG	22		290	348	0.72	0.90	
SPH4040330METG	33		460	552	0.55	0.70	

※Isat :DC current(A) that will cause inductance to drop approximately 30%

※Idc: DC current(A) that will cause an approximate ΔT of 20°C (at 25°C ambient)



SPH5050□□□□PTH (Thickness 2.0mm)

DARFON P/N	Inductance (uH)	Tolerance	DC Resistance (mΩ)		Heat Rating Current DC Amp.	Saturation Current DC Amps.	Measuring Condition
			Typ.	Max.	Idc(A) Max.	Isat(A) Max.	
SPH50501R0NPTH	0.47	± 30%	12	14	5.00	6.10	100KHz,1V
SPH50501R0NPTH	1.0		21	25	3.60	4.00	
SPH50501R5NPTH	1.5		26	31	3.20	3.35	
SPH50502R2NPTH	2.2		35	42	2.90	2.90	
SPH50503R3NPTH	3.3		48	58	2.40	2.40	
SPH50504R7MPTH	4.7	± 20%	60	72	2.00	2.00	
SPH50506R8MPTH	6.8		90	108	1.65	1.60	
SPH5050100MPTH	10		120	144	1.45	1.30	
SPH5050150MPTH	15		165	198	1.20	1.10	
SPH5050220MPTH	22		260	312	1.00	0.90	

SPH5050□□□□ETN (Thickness 4.0mm)

DARFON P/N	Inductance (uH)	Tolerance	DC Resistance (mΩ)		Heat Rating Current DC Amp.	Saturation Current DC Amps.	Measuring Condition
			Typ.	Max.	Idc(A) Max.	Isat(A) Max.	
SPH50501R5NETN	1.5	± 30%	17	22	4.50	6.40	100KHz,1V
SPH50502R2NETN	2.2		22	29	3.70	5.00	
SPH50503R3NETN	3.3		27	35	3.30	4.00	
SPH50504R7NETN	4.7		29	38	3.10	3.30	
SPH50506R8METN	6.8	± 20%	49	64	2.40	2.80	
SPH5050100METN	10		56	73	2.10	2.30	
SPH5050150METN	15		80	104	1.80	2.00	
SPH5050220METN	22		126	164	1.40	1.50	
SPH5050330METN	33		180	234	1.20	1.30	
SPH5050470METN	47		310	403	0.90	1.10	

※Isat :DC current(A) that will cause inductance to drop approximately 30%

※Idc: DC current(A) that will cause an approximate ΔT of 20°C (at 25°C ambient)

SPH6060□□□□PTC (Thickness 1.2mm)

DARFON P/N	Inductance (uH)	Tolerance	DC Resistance (mΩ)		Heat Rating Current DC Amp.	Saturation Current DC Amps.	Measuring Condition
			Typ.	Max.	Idc(A) Max.	Isat(A) Max.	
SPH60601R0NPTC	1.0	± 30%	50	60	2.40	3.00	100KHz,1V
SPH60601R5NPTC	1.5		67	80	2.10	2.60	
SPH60602R5NPTC	2.5		90	108	1.80	2.10	
SPH60603R3NPTC	3.3		105	126	1.70	1.80	
SPH60604R7MPTC	4.7	± 20%	125	150	1.55	1.60	
SPH60605R3MPTC	5.3		125	150	1.55	1.50	
SPH60606R8MPTC	6.8		165	198	1.35	1.30	
SPH6060100MPTC	10		200	240	1.20	1.00	
SPH6060150MPTC	15		295	354	0.80	0.80	
SPH6060220MPTC	22		465	558	0.65	0.76	
SPH6060330MPTC	33		580	696	0.55	0.59	
SPH6060470MPTC	47		965	1158	0.46	0.52	
SPH6060680MPTC	68		1160	1392	0.41	0.44	
SPH6060101MPTC	100	1670	2004	0.32	0.35		

SPH6060□□□□ETH (Thickness 2.0mm)

DARFON P/N	Inductance (uH)	Tolerance	DC Resistance (mΩ)		Heat Rating Current DC Amp.	Saturation Current DC Amps.	Measuring Condition
			Typ.	Max.	Idc(A) Max.	Isat(A) Max.	
SPH60600R8NETH	0.8	± 30%	20	24	4.10	6.40	100KHz,1V
SPH60601R5NETH	1.5		26	31	3.60	4.30	
SPH60602R2NETH	2.2		34	41	2.90	3.20	
SPH60603R3NETH	3.3		40	48	2.75	2.80	
SPH60604R7NETH	4.7		58	70	2.15	2.40	
SPH60606R8NETH	6.8		85	102	1.80	2.00	
SPH6060100METH	10	± 20%	125	150	1.50	1.90	
SPH6060220METH	22		290	348	0.95	1.25	

※Isat :DC current(A) that will cause inductance to drop approximately 30%

※Idc: DC current(A) that will cause an approximate ΔT of 20°C (at 25°C ambient)



SPH6060□□□□ETK (Thickness 2.8mm)

DARFON P/N	Inductance (uH)	Tolerance	DC Resistance (mΩ)		Heat Rating Current DC Amp.	Saturation Current DC Amps.	Measuring Condition
			Typ.	Max.	Idc(A) Max.	Isat(A) Max.	
SPH60600R9NETK	0.9	± 30%	13	17	4.60	6.70	100KHz, 1V
SPH60601R5NETK	1.5		16	21	4.20	5.10	
SPH60602R2NETK	2.2		20	26	3.70	4.20	
SPH60603R0NETK	3.0		23	30	3.40	3.60	
SPH60604R7METK	4.7	± 20%	31	40	3.00	2.70	
SPH60606R0METK	6.0		40	52	2.50	2.50	
SPH6060100METK	10		65	85	1.90	1.90	
SPH6060150METK	15		95	124	1.80	1.60	
SPH6060220METK	22		135	176	1.40	1.30	
SPH6060330METK	33		220	286	1.10	1.10	
SPH6060470METK	47		300	390	0.92	1.00	
SPH6060680METK	68		420	546	0.77	0.80	
SPH6060101METK	100	600	780	0.66	0.65		

SPH6060□□□□ETP (Thickness 4.5mm)

DARFON P/N	Inductance (uH)	Tolerance	DC Resistance (mΩ)		Heat Rating Current DC Amp.	Saturation Current DC Amps.	Measuring Condition
			Typ.	Max.	Idc(A) Max.	Isat(A) Max.	
SPH60601R0NETP	1.0	± 30%	14	18	4.50	9.80	100KHz, 1V
SPH60601R3NETP	1.3		16	21	4.20	8.20	
SPH60601R8NETP	1.8		19	25	3.90	7.20	
SPH60602R3NETP	2.3		22	29	3.60	6.40	
SPH60603R0NETP	3.0		24	31	3.30	5.60	
SPH60604R5METP	4.5	± 20%	30	39	3.10	4.40	
SPH60606R3METP	6.3		36	47	3.00	3.60	
SPH6060100METP	10		46	60	2.40	3.10	
SPH6060150METP	15		70	91	1.90	2.50	
SPH6060220METP	22		107	139	1.60	2.00	
SPH6060330METP	33		141	183	1.40	1.65	
SPH6060470METP	47		211	274	1.15	1.40	
SPH6060680METP	68		304	395	0.95	1.10	
SPH6060101METP	100	466	606	0.75	0.90		

※Isat :DC current(A) that will cause inductance to drop approximately 30%

※Idc: DC current(A) that will cause an approximate ΔT of 20°C (at 25°C ambient)



SPH8080□□□□ETN (Thickness 4.0mm)

DARFON P/N	Inductance (uH)	Tolerance	DC Resistance (mΩ)		Heat Rating Current DC Amp.	Saturation Current DC Amps.	Measuring Condition
			Typ.	Max.	Idc(A) Max.	Isat(A) Max.	
SPH80800R9NETN	0.9	± 30%	6	8	7.80	13.00	100KHz, 1V
SPH80801R4NETN	1.4		7	9	7.00	10.00	
SPH80802R0NETN	2.0		9	12	6.30	8.10	
SPH80803R6NETN	3.6		15	20	4.90	6.40	
SPH80804R7NETN	4.7		18	23	4.10	5.40	
SPH80806R8NETN	6.8		25	33	3.70	4.40	
SPH8080100METN	10	± 20%	34	44	3.10	3.80	
SPH8080150METN	15		50	65	2.40	2.90	
SPH8080220METN	22		66	86	2.20	2.40	

※Isat :DC current(A) that will cause inductance to drop approximately 30%

※Idc: DC current(A) that will cause an approximate ΔT of 20°C (at 25°C ambient)



■ Part Numbers & Characteristic (SPN Series)

SPN2016□□□□PSA (Thickness 1.0mm)

DARFON P/N	Inductance (uH)	Tolerance	DC Resistance (mΩ)		Heat Rating Current DC Amp.	Saturation Current DC Amps.	Measuring Condition
			Typ.	Max.	Idc(A) Typ.	Isat(A) Max.	
SPN2016R47NPSA	0.47	± 30%	49	59	2.60	2.56	1MHz,1V
SPN2016R68NPSA	0.68		71	86	2.25	2.2	
SPN20161R0NPSA	1.0		96	115	1.60	1.69	
SPN20161R5NPSA	1.5		143	172	1.40	1.46	
SPN20161R8NPSA	1.8		175	210	1.35	1.35	
SPN20162R2MPSA	2.2	± 20%	196	235	1.30	1.26	
SPN20163R3MPSA	3.3		247	296	1.05	0.90	
SPN20164R7MPSA	4.7		370	444	0.90	0.76	
SPN20166R8MPSA	6.8		664	797	0.60	0.72	
SPN2016100MPSA	10		1108	1330	0.45	0.55	

SPN2020□□□□PTC (Thickness 1.2mm)

DARFON P/N	Inductance (uH)	Tolerance	DC Resistance (mΩ)		Heat Rating Current DC Amp.	Saturation Current DC Amps.	Measuring Condition
			Typ.	Max.	Idc(A) Max.	Isat(A) Max.	
SPN20201R0NPTC	1.0	± 30%	70	84	1.70	1.90	100KHz,1V
SPN20201R5NPTC	1.5		90	108	1.50	1.65	
SPN20202R2MPTC	2.2	± 20%	107	128	1.37	1.35	
SPN20203R3MPTC	3.3		190	228	1.02	1.00	
SPN20204R7MPTC	4.7		241	289	0.91	0.90	

SPN2424□□□□PTA (Thickness 1.0mm)

DARFON P/N	Inductance (uH)	Tolerance	DC Resistance (mΩ)		Heat Rating Current DC Amp.	Saturation Current DC Amps.	Measuring Condition
			Typ.	Max.	Idc(A) Max.	Isat(A) Max.	
SPN2424R68NPTA	0.68	± 30%	60	72	1.57	2.20	100KHz,1V
SPN24241R0NPTA	1.0		70	84	1.41	1.80	
SPN24241R5MPTA	1.5	± 20%	110	132	1.16	1.55	
SPN24242R2MPTA	2.2		150	180	0.97	1.29	
SPN24243R3MPTA	3.3		220	264	0.77	1.00	
SPN24244R7MPTA	4.7		290	348	0.67	0.88	
SPN24246R8MPTA	6.8		410	492	0.57	0.75	
SPN2424100MPTA	10		690	828	0.45	0.55	
SPN2424150MPTA	15		1020	1224	0.37	0.47	
SPN2424220MPTA	22		1470	1764	0.30	0.39	

※Isat :DC current(A) that will cause inductance to drop approximately 30%

※Idc: DC current(A) that will cause an approximate ΔT of 20°C (at 25°C ambient)

(note: SPN2016□□□□PSA specifications is defined an approximately ΔT of 40°C)



SPN2424□□□□PTC (Thickness 1.2mm)

DARFON P/N	Inductance (uH)	Tolerance	DC Resistance (mΩ)		Heat Rating Current DC Amp.	Saturation Current DC Amps.	Measuring Condition
			Typ.	Max.	Idc(A) Max.	Isat(A) Max.	
SPN2424R47NPTC	0.47	± 30%	50	60	2.10	2.90	100KHz,1V
SPN24241R0NPTC	1.0		77	92	1.30	2.35	
SPN24241R5NPTC	1.5		100	120	1.15	2.10	
SPN24242R2MPTC	2.2	± 20%	140	168	1.00	1.70	
SPN24243R3MPTC	3.3		225	270	0.75	1.40	
SPN24244R7MPTC	4.7		300	360	0.65	1.15	
SPN24246R8MPTC	6.8		420	504	0.55	0.95	
SPN2424100MPTC	10		600	720	0.45	0.81	

SPN2520□□□□PSA (Thickness 1.0mm)

DARFON P/N	Inductance (uH)	Tolerance	DC Resistance (mΩ)		Heat Rating Current DC Amp.	Saturation Current DC Amps.	Measuring Condition
			Typ.	Max.	Idc(A) Typ.	Isat(A) Max.	
SPN2520R47NPSA	0.47	± 30%	38	46	2.65	2.50	1MHz,1V
SPN2520R68NPSA	0.68		52	62	2.20	2.05	
SPN25201R0NPSA	1.0		70	84	1.90	1.75	
SPN25201R5MPSA	1.5	± 20%	107	128	1.50	1.45	
SPN25202R2MPSA	2.2		158	190	1.20	1.20	
SPN25203R3MPSA	3.3		229	275	1.00	0.94	
SPN25204R7MPSA	4.7		332	398	0.82	0.80	
SPN25206R8MPSA	6.8		443	532	0.71	0.68	
SPN2520100MPSA	10		712	854	0.55	0.56	

※Isat :DC current(A) that will cause inductance to drop approximately 30%

※Idc: DC current(A) that will cause an approximate ΔT of 20℃ (at 25℃ ambient)

(note: SPN2520□□□□PSA specifications are defined an approximately ΔT of 40℃)



SPN2520□□□□PSC (Thickness 1.2mm)

DARFON P/N	Inductance (uH)	Tolerance	DC Resistance (mΩ)		Heat Rating Current DC Amp.	Saturation Current DC Amps.	Measuring Condition
			Typ.	Max.	Idc(A) Typ.	Isat(A) Max.	
SPN2520R47NPSC	0.47	± 30%	47	56	2.40	2.75	1MHz,1V
SPN25201R0NPSC	1.0		73	88	2.15	2.20	
SPN25201R5MPSC	1.5	± 20%	105	126	1.65	1.80	
SPN25202R2MPSC	2.2		129	155	1.55	1.55	
SPN25203R3MPSC	3.3		227	272	1.15	1.25	
SPN25204R7MPSC	4.7		338	406	1.08	1.05	
SPN25206R8MPSC	6.8		510	612	0.78	0.85	
SPN2520100MPSC	10		630	756	0.72	0.73	

SPN3030□□□□PTA (Thickness 1.0mm)

DARFON P/N	Inductance (uH)	Tolerance	DC Resistance (mΩ)		Heat Rating Current DC Amp.	Saturation Current DC Amps.	Measuring Condition
			Typ.	Max.	Idc(A) Max.	Isat(A) Max.	
SPN30301R0NPPTA	1.0	± 30%	65	78	1.40	1.30	100KHz,1V
SPN30301R5NPPTA	1.5		80	96	1.30	1.20	
SPN30302R2MPTA	2.2	± 20%	95	114	1.10	1.10	
SPN30303R3MPTA	3.3		140	168	0.94	0.87	
SPN30304R7MPTA	4.7		190	228	0.78	0.75	
SPN30306R8MPTA	6.8		300	360	0.63	0.61	
SPN3030100MPTA	10		450	540	0.51	0.50	
SPN3030150MPTA	15		740	888	0.40	0.40	
SPN3030220MPTA	22		1030	1236	0.35	0.35	
SPN3030330MPTA	33		1550	1860	0.28	0.26	
SPN3030470MPTA	47		2050	2460	0.24	0.22	

※Isat :DC current(A) that will cause inductance to drop approximately 30%

※Idc: DC current(A) that will cause an approximate ΔT of 20°C (at 25°C ambient)

(note: SPN2520□□□□PSC specifications are defined an approximately ΔT of 40°C)



SPN3030□□□□PTE (Thickness 1.5mm)

DARFON P/N	Inductance (uH)	Tolerance	DC Resistance (mΩ)		Heat Rating Current DC Amp.	Saturation Current DC Amps.	Measuring Condition
			Typ.	Max.	Idc(A) Max.	Isat(A) Max.	
SPN30301R0NPTE	1.0	± 30%	30	36	2.10	2.10	100KHz, 1V
SPN30301R5NPTE	1.5		40	48	1.82	1.80	
SPN30302R2MPTE	2.2	± 20%	60	72	1.50	1.48	
SPN30303R3MPTE	3.3		80	96	1.23	1.21	
SPN30304R7MPTE	4.7		120	144	1.04	1.02	
SPN30306R8MPTE	6.8		160	192	0.88	0.87	
SPN3030100MPTE	10		230	276	0.71	0.70	
SPN3030150MPTE	15		360	432	0.56	0.56	
SPN3030220MPTE	22		520	624	0.47	0.47	
SPN3030330MPTE	33		840	1008	0.37	0.39	
SPN3030470MPTE	47		1340	1608	0.30	0.32	

SPN4040□□□□ETA (Thickness 1.0mm)

DARFON P/N	Inductance (uH)	Tolerance	DC Resistance (mΩ)		Heat Rating Current DC Amp.	Saturation Current DC Amps.	Measuring Condition
			Typ.	Max.	Idc(A) Max.	Isat(A) Max.	
SPN40401R0NETA	1.0	± 30%	100	120	1.05	1.80	100KHz, 1V
SPN40402R2NETA	2.2		150	180	0.89	1.15	
SPN40403R3META	3.3	± 20%	180	216	0.82	1.10	
SPN40404R7META	4.7		210	252	0.75	0.90	
SPN40406R8META	6.8		300	360	0.62	0.74	
SPN4040100META	10		380	456	0.60	0.56	
SPN4040150META	15		510	612	0.51	0.47	
SPN4040220META	22		870	1044	0.40	0.36	
SPN4040330META	33		1540	1848	0.30	0.28	
SPN4040470META	47		1810	2172	0.28	0.24	

※Isat :DC current(A) that will cause inductance to drop approximately 30%

※Idc: DC current(A) that will cause an approximate ΔT of 20°C (at 25°C ambient)



SPN4040□□□□ETC (Thickness 1.2mm)

DARFON P/N	Inductance (uH)	Tolerance	DC Resistance (mΩ)		Heat Rating Current DC Amp.	Saturation Current DC Amps.	Measuring Condition
			Typ.	Max.	Idc(A) Max.	Isat(A) Max.	
SPN40401R0NETC	1.0	± 30%	60	72	1.50	2.50	100KHz,1V
SPN40402R2METC	2.2	± 20%	90	108	1.20	1.65	
SPN40403R3METC	3.3		130	156	0.98	1.20	
SPN40404R7METC	4.7		140	168	0.96	1.05	
SPN40406R8METC	6.8		180	216	0.84	0.90	
SPN4040100METC	10		240	288	0.77	0.74	
SPN4040150METC	15		400	480	0.60	0.56	
SPN4040220METC	22		480	576	0.54	0.51	
SPN4040330METC	33		810	972	0.42	0.40	
SPN4040470METC	47		1000	1200	0.37	0.35	

SPN4040□□□□ETG (Thickness 1.8mm)

DARFON P/N	Inductance (uH)	Tolerance	DC Resistance (mΩ)		Heat Rating Current DC Amp.	Saturation Current DC Amps.	Measuring Condition
			Typ.	Max.	Idc(A) Max.	Isat(A) Max.	
SPN40401R0NETG	1.0	± 30%	30	36	1.83	4.00	100KHz,1V
SPN40402R2METG	2.2	± 20%	60	72	1.44	2.70	
SPN40403R3METG	3.3		70	84	1.23	2.00	
SPN40404R7METG	4.7		90	108	1.20	1.70	
SPN40406R8METG	6.8		110	132	1.06	1.45	
SPN4040100METG	10		180	216	0.84	1.20	
SPN4040150METG	15		250	300	0.65	0.94	
SPN4040220METG	22		360	432	0.59	0.80	
SPN4040330METG	33		530	636	0.49	0.65	
SPN4040470METG	47		650	780	0.42	0.57	
SPN4040680METG	68		1000	1200	0.32	0.47	
SPN4040101METG	100		1500	1800	0.27	0.40	
SPN4040151METG	150		2500	3000	0.22	0.31	
SPN4040221METG	220		4000	4800	0.17	0.27	

※Isat :DC current(A) that will cause inductance to drop approximately 30%

※Idc: DC current(A) that will cause an approximate ΔT of 20°C (at 25°C ambient)



SPN5050□□□□PTA (Thickness 1.0mm)

DARFON P/N	Inductance (uH)	Tolerance	DC Resistance (mΩ)		Heat Rating Current DC Amp.	Saturation Current DC Amps.	Measuring Condition
			Typ.	Max.	Idc(A) Max.	Isat(A) Max.	
SPN50501R0NPTA	1.0	± 30%	70	84	1.75	2.35	100KHz,1V
SPN50502R2NPTA	2.2		105	126	1.40	1.50	
SPN50503R3MPTA	3.3	± 20%	125	150	1.25	1.40	
SPN50504R7MPTA	4.7		145	174	1.15	1.20	
SPN50506R8MPTA	6.8		185	222	1.00	1.00	
SPN5050100MPTA	10		250	300	0.90	0.85	
SPN5050150MPTA	15		400	480	0.65	0.68	
SPN5050220MPTA	22		600	720	0.45	0.55	

SPN5050□□□□PTC (Thickness 1.2mm)

DARFON P/N	Inductance (uH)	Tolerance	DC Resistance (mΩ)		Heat Rating Current DC Amp.	Saturation Current DC Amps.	Measuring Condition
			Typ.	Max.	Idc(A) Max.	Isat(A) Max.	
SPN50501R0NPTC	1.0	± 30%	53	64	2.30	4.50	100KHz,1V
SPN50501R5NPTC	1.5		70	84	2.20	3.80	
SPN50502R2MPTC	2.2	± 20%	85	102	2.00	3.10	
SPN50503R3MPTC	3.3		160	192	1.45	2.40	
SPN50504R7MPTC	4.7		180	216	1.40	2.20	
SPN50506R8MPTC	6.8		260	312	1.10	1.70	
SPN5050100MPTC	10		420	504	0.85	1.40	
SPN5050150MPTC	15		670	804	0.64	1.20	

SPN5050□□□□PTD (Thickness 1.4mm)

DARFON P/N	Inductance (uH)	Tolerance	DC Resistance (mΩ)		Heat Rating Current DC Amp.	Saturation Current DC Amps.	Measuring Condition
			Typ.	Max.	Idc(A) Max.	Isat(A) Max.	
SPN5050R47NPTD	0.47	± 30%	25	30	3.30	5.80	100KHz,1V
SPN50501R2NPTD	1.2		45	54	2.40	3.80	
SPN50502R2NPTD	2.2		65	78	2.00	2.80	
SPN50503R3NPTD	3.3		80	96	1.70	2.35	
SPN50504R7NPTD	4.7		100	120	1.40	2.05	
SPN50506R8MPTD	6.8	± 20%	150	180	1.20	1.60	
SPN5050100MPTD	10		200	240	1.05	1.40	
SPN5050150MPTD	15		320	384	0.65	1.10	
SPN5050220MPTD	22		450	540	0.55	0.90	

※Isat :DC current(A) that will cause inductance to drop approximately 30%

※Idc: DC current(A) that will cause an approximate ΔT of 20°C (at 25°C ambient)



SPN5050□□□□ETI (Thickness 2.4mm)

DARFON P/N	Inductance (uH)	Tolerance	DC Resistance (mΩ)		Heat Rating Current DC Amp.	Saturation Current DC Amps.	Measuring Condition
			Typ.	Max.	Idc(A) Max.	Isat(A) Max.	
SPN50501R0NETI	1.0	± 30%	16	19	4.40	5.80	100KHz,1V
SPN50501R5NETI	1.5		22	26	3.60	5.20	
SPN50502R2NETI	2.2		29	35	3.10	4.10	
SPN50503R3NETI	3.3		43	52	2.40	3.10	
SPN50504R7METI	4.7	± 20%	55	66	2.00	2.70	
SPN50506R8METI	6.8		80	96	1.60	2.20	
SPN5050100METI	10		125	150	1.20	1.70	
SPN5050150METI	15		170	204	1.00	1.40	
SPN5050220METI	22		230	276	0.82	1.20	
SPN5050330METI	33		370	444	0.63	1.00	

SPN5050□□□□ETL (Thickness 3.0mm)

DARFON P/N	Inductance (uH)	Tolerance	DC Resistance (mΩ)		Heat Rating Current DC Amp.	Saturation Current DC Amps.	Measuring Condition
			Typ.	Max.	Idc(A) Max.	Isat(A) Max.	
SPN5050R47NETL	0.47	± 30%	10	13	5.00	9.00	100KHz,1V
SPN50501R0NETL	1.0		15	20	4.00	6.60	
SPN50502R2NETL	2.2		23	30	3.50	4.20	
SPN50503R3METL	3.3	± 20%	30	39	3.00	3.60	
SPN50504R7METL	4.7		35	46	2.60	3.10	
SPN50506R8METL	6.8		52	68	2.30	2.50	
SPN5050100METL	10		70	91	1.70	2.10	
SPN5050150METL	15		125	163	1.40	1.60	
SPN5050220METL	22		180	234	1.05	1.40	
SPN5050330METL	33		225	293	0.80	1.15	
SPN5050470METL	47	325	423	0.70	0.95		

※Isat :DC current(A) that will cause inductance to drop approximately 30%

※Idc: DC current(A) that will cause an approximate ΔT of 20°C (at 25°C ambient)



SPN5050□□□□ETN (Thickness 4.0mm)

DARFON P/N	Inductance (uH)	Tolerance	DC Resistance (mΩ)		Heat Rating Current DC Amp.	Saturation Current DC Amps.	Measuring Condition
			Typ.	Max.	Idc(A) Max.	Isat(A) Max.	
SPN50501R5NETN	1.5	± 30%	20	26	3.60	6.00	100KHz,1V
SPN50502R2NETN	2.2		22	29	3.50	4.60	
SPN50503R3NETN	3.3		27	35	3.30	3.80	
SPN50504R7NETN	4.7		29	38	3.10	3.30	
SPN50506R8METN	6.8	± 20%	49	64	2.30	2.60	
SPN5050100METN	10		56	73	2.10	2.30	
SPN5050150METN	15		80	104	1.80	2.00	
SPN5050220METN	22		126	164	1.40	1.60	
SPN5050330METN	33		180	234	1.20	1.30	
SPN5050470METN	47		310	403	0.90	1.10	

SPN6060□□□□PTA (Thickness 1.0mm)

DARFON P/N	Inductance (uH)	Tolerance	DC Resistance (mΩ)		Heat Rating Current DC Amp.	Saturation Current DC Amps.	Measuring Condition
			Typ.	Max.	Idc(A) Max.	Isat(A) Max.	
SPN60601R5MPTA	1.5	± 20%	90	108	1.90	2.40	100KHz,1V
SPN60602R2MPTA	2.2		110	132	1.70	1.90	
SPN60603R3MPTA	3.3		135	162	1.50	1.60	
SPN60604R7MPTA	4.7		165	198	1.40	1.40	
SPN60606R8MPTA	6.8		220	264	1.00	1.20	
SPN6060100MPTA	10		270	324	0.85	1.00	
SPN6060220MPTA	22		580	696	0.70	0.65	

※Isat :DC current(A) that will cause inductance to drop approximately 30%

※Idc: DC current(A) that will cause an approximate ΔT of 20℃ (at 25℃ ambient)



SPN6060□□□□PTC (Thickness 1.2mm)

DARFON P/N	Inductance (uH)	Tolerance	DC Resistance (mΩ)		Heat Rating Current DC Amp.	Saturation Current DC Amps.	Measuring Condition
			Typ.	Max.	Idc(A) Max.	Isat(A) Max.	
SPN60602R5NPTC	2.5	± 30%	90	108	1.73	2.10	100KHz, 1V
SPN60604R0NPTC	4.0		105	126	1.57	1.80	
SPN60605R3MPTC	5.3	± 20%	125	150	1.40	1.50	
SPN60606R8MPTC	6.8		165	198	1.18	1.30	
SPN6060100MPTC	10		235	282	1.00	1.00	
SPN6060150MPTC	15		330	396	0.79	0.80	
SPN6060220MPTC	22		530	636	0.63	0.76	
SPN6060330MPTC	33		700	840	0.53	0.59	
SPN6060470MPTC	47		1050	1260	0.46	0.52	
SPN6060680MPTC	68		1350	1620	0.41	0.44	
SPN6060101MPTC	100		2180	2616	0.32	0.35	

SPN6060□□□□PTD (Thickness 1.4mm)

DARFON P/N	Inductance (uH)	Tolerance	DC Resistance (mΩ)		Heat Rating Current DC Amp.	Saturation Current DC Amps.	Measuring Condition
			Typ.	Max.	Idc(A) Max.	Isat(A) Max.	
SPN60601R2NPTD	1.2	± 30%	42	50	2.75	4.00	100KHz, 1V
SPN60602R2NPTD	2.2		55	66	2.30	3.00	
SPN60603R3NPTD	3.3		75	90	2.00	2.50	
SPN60604R7MPTD	4.7	± 20%	090	108	1.90	2.00	
SPN60606R8MPTD	6.8		115	138	1.65	1.70	
SPN6060100MPTD	10		140	168	1.40	1.40	
SPN6060150MPTD	15		210	252	1.20	1.15	
SPN6060220MPTD	22		300	360	1.00	0.95	

※Isat :DC current(A) that will cause inductance to drop approximately 30%

※Idc: DC current(A) that will cause an approximate ΔT of 20°C (at 25°C ambient)



SPN6060□□□□ETH (Thickness 2.0mm)

DARFON P/N	Inductance (uH)	Tolerance	DC Resistance (mΩ)		Heat Rating Current DC Amp.	Saturation Current DC Amps.	Measuring Condition
			Typ.	Max.	Idc(A) Max.	Isat(A) Max.	
SPN60600R8NETH	0.8	± 30%	20	24	3.80	5.50	100KHz,1V
SPN60601R5NETH	1.5		26	31	3.20	4.00	
SPN60602R2NETH	2.2		34	41	2.70	3.20	
SPN60603R3NETH	3.3		40	48	2.60	2.80	
SPN60604R7NETH	4.7		58	70	2.00	2.40	
SPN60606R8NETH	6.8		85	102	1.80	2.00	
SPN6060100METH	10	± 20%	125	150	1.40	1.70	
SPN6060220METH	22		290	348	0.95	1.05	

SPN6060□□□□ETK (Thickness 2.8mm)

DARFON P/N	Inductance (uH)	Tolerance	DC Resistance (mΩ)		Heat Rating Current DC Amp.	Saturation Current DC Amps.	Measuring Condition
			Typ.	Max.	Idc(A) Max.	Isat(A) Max.	
SPN60600R9NETK	0.9	± 30%	13	17	4.60	6.60	100KHz,1V
SPN60601R5NETK	1.5		16	21	4.20	5.00	
SPN60602R2NETK	2.2		20	26	3.70	4.20	
SPN60603R0NETK	3.0		23	30	3.40	3.60	
SPN60604R7METK	4.7	± 20%	31	40	3.00	2.70	
SPN60606R0METK	6.0		40	52	2.50	2.50	
SPN6060100METK	10		65	85	1.90	1.90	
SPN6060150METK	15		95	124	1.80	1.60	
SPN6060220METK	22		135	176	1.40	1.30	
SPN6060330METK	33		220	286	1.10	1.10	
SPN6060470METK	47		300	390	0.92	0.95	
SPN6060680METK	68		420	546	0.77	0.76	
SPN6060101METK	100	600	780	0.66	0.62		

※Isat :DC current(A) that will cause inductance to drop approximately 30%

※Idc: DC current(A) that will cause an approximate ΔT of 20°C (at 25°C ambient)



SPN6060□□□□ETP (Thickness 4.5mm)

DARFON P/N	Inductance (uH)	Tolerance	DC Resistance (mΩ)		Heat Rating Current DC Amp.	Saturation Current DC Amps.	Measuring Condition
			Typ.	Max.	Idc(A) Max.	Isat(A) Max.	
SPN60601R0NETP	1.0	± 30%	14	18	4.20	8.50	100KHz, 1V
SPN60601R3NETP	1.3		16	21	4.00	8.00	
SPN60601R8NETP	1.8		18	23	3.70	7.00	
SPN60602R3NETP	2.3		21	27	3.50	6.00	
SPN60603R0NETP	3.0		24	31	3.20	5.00	
SPN60604R5METP	4.5	± 20%	31	40	3.00	4.00	
SPN60606R3METP	6.3		38	49	2.80	3.80	
SPN6060100METP	10		47	61	2.50	3.00	
SPN6060150METP	15		77	100	1.90	2.30	
SPN6060220METP	22		115	150	1.50	1.90	
SPN6060330METP	33		145	189	1.40	1.50	
SPN6060470METP	47		220	286	1.10	1.30	
SPN6060680METP	68		330	429	0.90	1.00	
SPN6060101METP	100	500	650	0.70	0.80		

SPN8080□□□□ETL (Thickness 3.0mm)

DARFON P/N	Inductance (uH)	Tolerance	DC Resistance (mΩ)		Heat Rating Current DC Amp.	Saturation Current DC Amps.	Measuring Condition
			Typ.	Max.	Idc(A) Max.	Isat(A) Max.	
SPN80801R0NETL	1.0	± 30%	9	12	6.20	7.80	100KHz, 1V
SPN80801R5NETL	1.5		12	16	5.30	6.20	
SPN80802R2NETL	2.2		15	20	4.80	4.90	
SPN80803R3METL	3.3	± 20%	19	25	4.30	4.20	
SPN80804R7METL	4.7		22	29	4.00	3.60	
SPN80806R8METL	6.8		29	38	3.40	3.00	
SPN8080100METL	10		33	43	3.00	2.40	
SPN8080150METL	15		60	78	2.20	2.00	
SPN8080220METL	22		70	91	1.90	1.75	
SPN8080330METL	33		120	156	1.50	1.30	
SPN8080470METL	47	170	221	1.30	1.10		

※Isat :DC current(A) that will cause inductance to drop approximately 30%

※Idc: DC current(A) that will cause an approximate ΔT of 20°C (at 25°C ambient)



SPN8080□□□□ETN (Thickness 4.0mm)

DARFON P/N	Inductance (uH)	Tolerance	DC Resistance (mΩ)		Heat Rating Current DC Amp.	Saturation Current DC Amps.	Measuring Condition
			Typ.	Max.	Idc(A) Max.	Isat(A) Max.	
SPN80800R9NETN	0.9	± 30%	6	8	7.80	11.00	100KHz, 1V
SPN80801R4NETN	1.4		7	9	7.00	9.00	
SPN80802R0NETN	2.0		9	12	6.30	7.40	
SPN80803R6NETN	3.6		15	20	4.90	5.30	
SPN80804R7NETN	4.7		18	23	4.10	4.70	
SPN80806R8NETN	6.8		25	33	3.70	4.00	
SPN8080100METN	10	± 20%	34	44	3.10	3.40	
SPN8080150METN	15		50	65	2.40	2.70	
SPN8080220METN	22		66	86	2.20	2.20	
SPN8080330METN	33		100	130	1.70	1.90	
SPN8080470METN	47		150	195	1.40	1.50	
SPN8080680METN	68		230	299	1.10	1.20	
SPN8080101METN	100		290	377	1.00	1.00	

※Isat :DC current(A) that will cause inductance to drop approximately 30%

※Idc: DC current(A) that will cause an approximate ΔT of 20°C (at 25°C ambient)

Testing Condition & Requirements

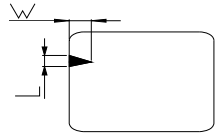
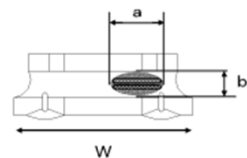
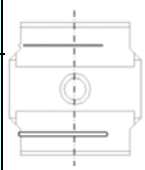
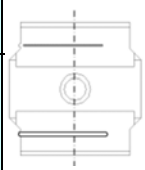
No.	Item	Specification Description	Test Method
1.	Product temperature range	Operation temp.: -40°C ~ +125°C (Including self-generated heat) Storage temp.: -40°C ~ +85°C	---
2.	Appearance	No defects or abnormalities.	Visual inspection
2.1	Core chipping	The appearance standard of the chipping size in top side, of bottom side ferrite core is following dimension. L : 0.5 mm (max) W: 0.5 mm (max)	Using calipers 
2.2	Void appearance tolerance limitation	Size of voids occurring to coating resin is specified as following. 1. Width direction (dimension a) : acceptable when $a \leq w/2$ nonconforming when $a > w/2$ 2. Length direction (dimension b) : it is not specified. 3. When total area of voids(including one exposing coil) occurring to each sides is not greater than 50% of coating resin area that is acceptable	Using calipers 
2.3	Electrode appearance criterion for exposed wire	 <Cross section of wire joint part> <Appearance judgment> Conforming Only top side of wire is exposed. (regardless of whole top side of wire exposed) Wire is soldered insufficiently and less than half of outer diameter is covered with solder. Less than 1/2 of joint side length. (More than 1/2 is selected as defect)	Visual inspection
3.	Solder ability	 <Cross section of wire joint part> <Appearance judgment> Conforming Only top side of wire is exposed. (regardless of whole top side of wire exposed) Wire is soldered insufficiently and less than half of outer diameter is covered with solder. Less than 1/2 of joint side length. (More than 1/2 is selected as defect)	Solder heat proof : 1. Preheating : 160±10°C 90s 2. Retention time: 245±5°C for 3 ± 1 sec
4.	Vibration	Inductance change : within ± 10% without mechanical damage such as break	1. Vibration frequency : (10Hz to 55Hz to 10Hz) in 60 sec. as a period 2. Vibration time : period cycled for 2 hr in each of 3 mutual perpendicular directions 3. Amplitude: 1.5mm max.
5.	Terminal strength	No detachment of terminal pin and no breakage of wire	Add static load 4.9N(500gf) to inductor through hole of test board for 10 ± 2 sec
6.	Thermal shock	Inductance change : within ± 10% without mechanical damage such as break	1. Repeat 100 cycles as follow : (-40°C ± 2°C , 30±3 minutes) → (room temperature , 5 minutes) → (+125°C ± 2°C , 30±3 minutes) → (room temperature , 5 minutes) 2. Recovery : 48+4/-0 hours of recovery under the standard condition after the test.
7.	High temperature resistance	Inductance change : within ± 10% without mechanical damage such as break	1. Environment condition : 85°C±2°C 2. Applied current : rated current 3. Duration : 500 +4/-0 hours
8.	Humidity resistance	Inductance change : within ± 10% without mechanical damage such as break	1. Environment condition : 60°C±2°C 2. Humidity : 90~95% 3. Applied current : rated current 4. Duration : 500 +4/-0 hours

No.	Item	Specification Description	Test Method
9.	Low temperature storage	Inductance change : within $\pm 10\%$ without mechanical damage such as break	Store temperature : -40°C \pm 2°C for total 500 +4/-0 hours
10.	High temperature storage	Inductance change : within $\pm 10\%$ without mechanical damage such as break	Store temperature : +125°C \pm 2°C for total 500 +4/-0 hours

Reflow Profile Chart (Reference)

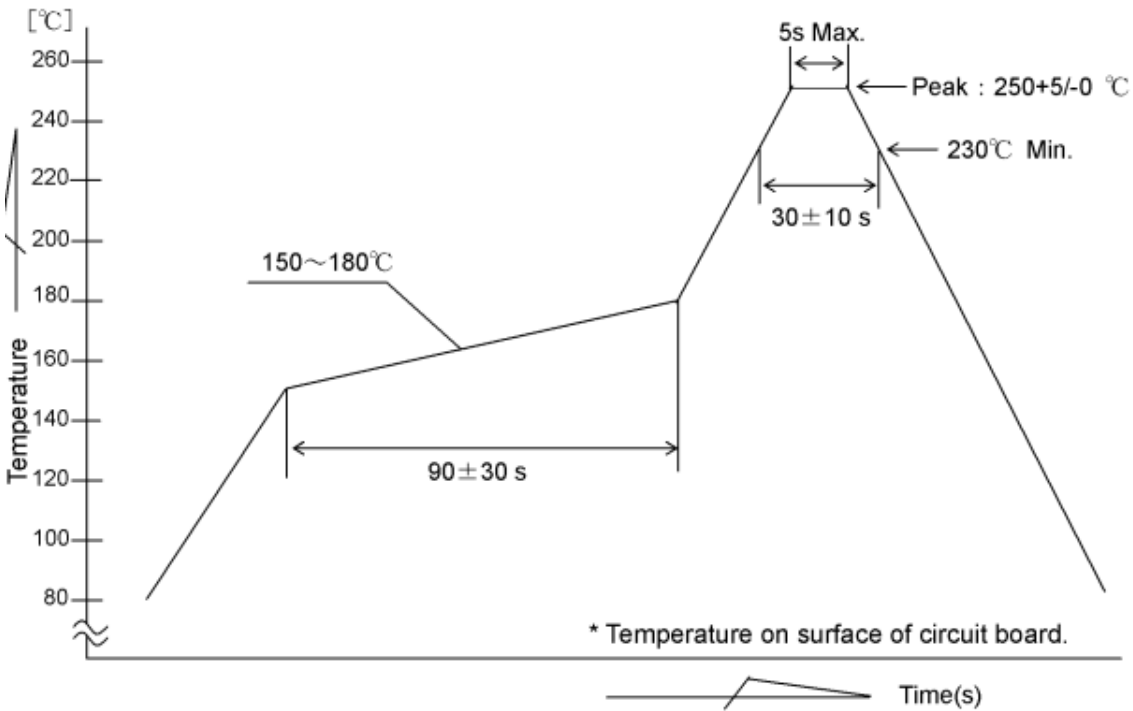

The products may be exposed to reflow soldering process of above profile up to two times.

Packaging Specification

● **Embossed Tape**

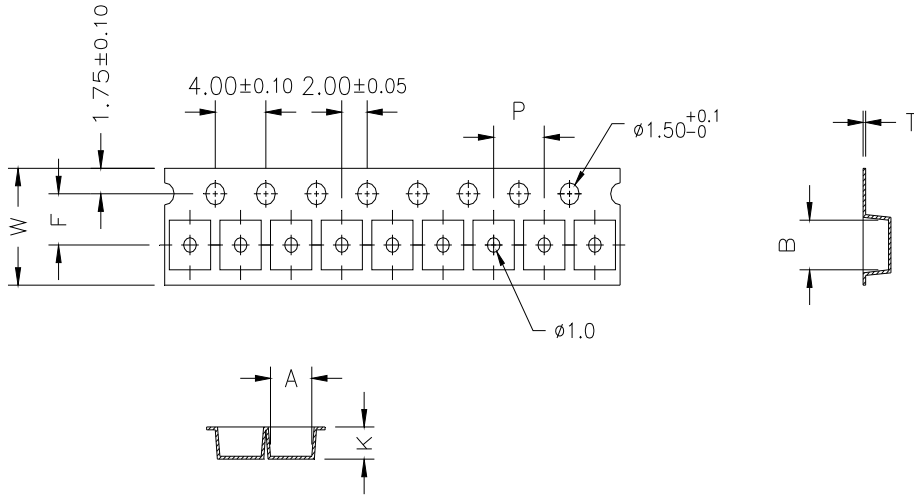

TYPE	PRODUCT SIZE CODE													
	A		B		P		F		W		T		K	
	SIZE	TOL	SIZE	TOL	SIZE	TOL	SIZE	TOL	SIZE	TOL	SIZE	TOL	SIZE	TOL
SPM2016 □□□□PSA	1.84 (0.072)	± 0.1 (±0.004)	2.25 (0.089)	± 0.1 (±0.004)	4.0 (0.157)	± 0.1 (±0.004)	3.5 (0.138)	± 0.05 (±0.004)	8.00 (0.315)	± 0.1 (±0.004)	0.22 (0.0087)	± 0.05 (±0.002)	1.15 (0.045)	± 0.1 (±0.004)
SPM2016 □□□□PSC	1.84 (0.072)	± 0.1 (±0.004)	2.25 (0.089)	± 0.1 (±0.004)	4.0 (0.157)	± 0.1 (±0.004)	3.5 (0.138)	± 0.05 (±0.004)	8.00 (0.315)	± 0.1 (±0.004)	0.22 (0.0087)	± 0.05 (±0.002)	1.15 (0.045)	± 0.1 (±0.004)
SPM2520 □□□□PSA	2.6 (0.102)	± 0.1 (±0.004)	3.0 (0.118)	± 0.1 (±0.004)	4.0 (0.157)	± 0.1 (±0.004)	3.5 (0.138)	± 0.1 (±0.004)	8.0 (0.315)	± 0.1 (±0.004)	0.3 (0.012)	± 0.05 (±0.002)	1.35 (0.053)	± 0.1 (±0.004)
SPM2520 □□□□PSC	2.6 (0.102)	± 0.1 (±0.004)	3.0 (0.118)	± 0.1 (±0.004)	4.0 (0.157)	± 0.1 (±0.004)	3.5 (0.138)	± 0.1 (±0.004)	8.0 (0.315)	± 0.1 (±0.004)	0.3 (0.012)	± 0.05 (±0.002)	1.35 (0.053)	± 0.1 (±0.004)
SPM3030 □□□□PSC	3.4 (0.134)	± 0.1 (±0.004)	3.8 (0.150)	± 0.1 (±0.004)	4.0 (0.157)	± 0.1 (±0.004)	3.5 (0.138)	± 0.1 (±0.004)	8.0 (0.315)	± 0.3 (±0.0118)	0.3 (0.012)	± 0.05 (±0.002)	1.40 (0.053)	± 0.1 (±0.004)
SPM4040 □□□□ESC	4.4 (0.173)	± 0.1 (±0.004)	5.1 (0.201)	± 0.1 (±0.004)	8.0 (0.315)	± 0.1 (±0.004)	5.5 (0.0.217)	± 0.1 (±0.004)	12.0 (0.4725)	± 0.3 (±0.012)	0.35 (0.014)	± 0.05 (±0.002)	1.40 (0.055)	± 0.1 (±0.004)
SPM4040 □□□□ESH	4.4 (0.173)	± 0.1 (±0.004)	5.1 (0.201)	± 0.1 (±0.004)	8.0 (0.315)	± 0.1 (±0.004)	5.5 (0.217)	± 0.1 (±0.004)	12.0 (0.4725)	± 0.3 (±0.012)	0.35 (0.014)	± 0.05 (±0.002)	2.20 (0.087)	± 0.1 (±0.004)
SPM4040 □□□□ECH	4.4 (0.173)	± 0.1 (±0.004)	5.1 (0.201)	± 0.1 (±0.004)	8.0 (0.315)	± 0.1 (±0.004)	5.5 (0.217)	± 0.1 (±0.004)	12.0 (0.4725)	± 0.3 (±0.012)	0.35 (0.014)	± 0.05 (±0.002)	2.50 (0.098)	± 0.1 (±0.004)
SPM5050 □□□□ESC	5.40 (0.213)	± 0.1 (±0.004)	6.1 (0.240)	± 0.1 (±0.004)	8.0 (0.315)	± 0.1 (±0.004)	5.5 (0.217)	± 0.1 (±0.004)	12.0 (0.472)	± 0.3 (±0.012)	0.35 (0.014)	± 0.05 (±0.002)	1.6 (0.063)	± 0.1 (±0.004)
SPM5050 □□□□ESE	5.40 (0.213)	± 0.1 (±0.004)	6.1 (0.240)	± 0.1 (±0.004)	8.0 (0.315)	± 0.1 (±0.004)	5.5 (0.217)	± 0.1 (±0.004)	12.0 (0.472)	± 0.3 (±0.012)	0.35 (0.014)	± 0.05 (±0.002)	1.6 (0.063)	± 0.1 (±0.004)
SPM5050 □□□□ESH	5.60 (0.213)	± 0.1 (±0.004)	6.0 (0.236)	± 0.1 (±0.004)	8.0 (0.315)	± 0.1 (±0.004)	5.5 (0.217)	± 0.1 (±0.004)	12.0 (0.472)	± 0.3 (±0.012)	0.35 (0.014)	± 0.05 (±0.002)	2.1 (0.083)	± 0.1 (±0.004)
SPM5050 □□□□ECL	5.40 (0.213)	± 0.1 (±0.004)	6.0 (0.236)	± 0.1 (±0.004)	8.0 (0.315)	± 0.1 (±0.004)	5.5 (0.217)	± 0.1 (±0.004)	12.0 (0.472)	± 0.3 (±0.012)	0.35 (0.014)	± 0.05 (±0.002)	3.2 (0.126)	± 0.1 (±0.004)
SPM7070 □□□□ESC	6.95 (0.274)	± 0.1 (±0.004)	7.4 (0.291)	± 0.1 (±0.004)	12.0 (0.472)	± 0.1 (±0.004)	7.5 (0.295)	± 0.1 (±0.004)	16.0 (0.630)	± 0.3 (±0.012)	0.35 (0.014)	± 0.05 (±0.002)	1.5 (0.059)	± 0.1 (±0.004)
SPM7070 □□□□ESE	7.0 (0.276)	± 0.1 (±0.004)	7.5 (0.295)	± 0.1 (±0.004)	12.0 (0.472)	± 0.1 (±0.004)	7.5 (0.295)	± 0.1 (±0.004)	16.0 (0.630)	± 0.3 (±0.012)	0.35 (0.014)	± 0.05 (±0.002)	1.7 (0.067)	± 0.1 (±0.004)
SPM7070 □□□□ESG	6.95 (0.274)	± 0.1 (±0.004)	7.45 (0.293)	± 0.1 (±0.004)	12.0 (0.472)	± 0.1 (±0.004)	7.5 (0.295)	± 0.1 (±0.004)	16.0 (0.630)	± 0.3 (±0.012)	0.35 (0.014)	± 0.05 (±0.002)	2.1 (0.827)	± 0.1 (±0.004)
SPM7070 □□□□ESL	7.6 (0.299)	± 0.1 (±0.004)	7.6 (0.299)	± 0.1 (±0.004)	12.0 (0.472)	± 0.1 (±0.004)	7.5 (0.295)	± 0.1 (±0.004)	16.0 (0.630)	± 0.3 (±0.012)	0.4 (0.016)	± 0.05 (±0.002)	3.6 (0.142)	± 0.1 (±0.004)
SPM7070 □□□□ERL	7.6 (0.299)	± 0.1 (±0.004)	7.6 (0.299)	± 0.1 (±0.004)	12.0 (0.472)	± 0.1 (±0.004)	7.5 (0.295)	± 0.1 (±0.004)	16.0 (0.630)	± 0.3 (±0.012)	0.4 (0.016)	± 0.05 (±0.002)	3.6 (0.142)	± 0.1 (±0.004)
SPM7070 □□□□ECL	7.6 (0.299)	± 0.1 (±0.004)	7.6 (0.299)	± 0.1 (±0.004)	12.0 (0.472)	± 0.1 (±0.004)	7.5 (0.295)	± 0.1 (±0.004)	16.0 (0.630)	± 0.3 (±0.012)	0.4 (0.016)	± 0.05 (±0.002)	3.6 (0.142)	± 0.1 (±0.004)
SPM7070 □□□□ESQ	6.9 (0.272)	± 0.1 (±0.004)	7.5 (0.295)	± 0.1 (±0.004)	12.0 (0.472)	± 0.1 (±0.004)	7.5 (0.295)	± 0.1 (±0.004)	16.0 (0.630)	± 0.3 (±0.012)	0.35 (0.014)	± 0.05 (±0.002)	5.3 (0.209)	± 0.1 (±0.004)
SPM1010 □□□□ESN	10.9 (0.429)	± 0.1 (±0.004)	12.2 (0.480)	± 0.1 (±0.004)	16.0 (0.630)	± 0.1 (±0.004)	11.5 (0.453)	± 0.1 (±0.004)	24.0 (0.984)	± 0.3 (±0.012)	0.4 (0.016)	± 0.05 (±0.002)	4.5 (0.177)	± 0.1 (±0.004)
SPM1010 □□□□ECN	10.9 (0.429)	± 0.1 (±0.004)	12.2 (0.480)	± 0.1 (±0.004)	16.0 (0.630)	± 0.1 (±0.004)	11.5 (0.453)	± 0.1 (±0.004)	24.0 (0.984)	± 0.3 (±0.012)	0.4 (0.016)	± 0.05 (±0.002)	4.5 (0.177)	± 0.1 (±0.004)
SPM1313 □□□□ECM	13.3 (0.524)	± 0.1 (±0.004)	14.5 (0.571)	± 0.1 (±0.004)	20.0 (0.787)	± 0.1 (±0.004)	11.5 (0.453)	± 0.1 (±0.004)	24.0 (0.984)	± 0.3 (±0.012)	0.4 (0.016)	± 0.05 (±0.002)	4.0 (0.157)	± 0.3 (±0.012)
SPM1313 □□□□ESQ	13.3 (0.524)	± 0.1 (±0.004)	14.5 (0.571)	± 0.1 (±0.004)	20.0 (0.787)	± 0.1 (±0.004)	11.5 (0.453)	± 0.1 (±0.004)	24.0 (0.984)	± 0.3 (±0.012)	0.4 (0.016)	± 0.05 (±0.002)	6.45 (0.254)	± 0.25 (±0.01)
SPM1313 □□□□ESR	13.3 (0.524)	± 0.1 (±0.004)	14.5 (0.571)	± 0.1 (±0.004)	20.0 (0.787)	± 0.1 (±0.004)	11.5 (0.453)	± 0.1 (±0.004)	24.0 (0.984)	± 0.3 (±0.012)	0.4 (0.016)	± 0.05 (±0.002)	6.45 (0.254)	± 0.25 (±0.01)

Unit : mm(inch)

Series	PRODUCT SIZE CODE													
	A		B		P		F		W		T		K	
	SIZE	TOL	SIZE	TOL	SIZE	TOL	SIZE	TOL	SIZE	TOL	SIZE	TOL	SIZE	TOL
SPN6060□□□□ETH	6.3 (0.248)	± 0.1 (±0.004)	6.3 (0.248)	± 0.1 (±0.004)	8.0 (0.315)	± 0.1 (±0.004)	5.5 (0.217)	± 0.1 (±0.004)	12.0 (0.472)	± 0.3 (±0.012)	0.4 (0.016)	± 0.1 (±0.004)	2.3 (0.090)	± 0.1 (±0.004)
SPH6060□□□□ETH	6.3 (0.248)	± 0.1 (±0.004)	6.3 (0.248)	± 0.1 (±0.004)	8.0 (0.315)	± 0.1 (±0.004)	5.5 (0.217)	± 0.1 (±0.004)	12.0 (0.472)	± 0.3 (±0.012)	0.4 (0.016)	± 0.1 (±0.004)	2.3 (0.090)	± 0.1 (±0.004)
SPN6060□□□□ETK	6.3 (0.248)	± 0.1 (±0.004)	6.3 (0.248)	± 0.1 (±0.004)	8.0 (0.315)	± 0.1 (±0.004)	5.5 (0.217)	± 0.1 (±0.004)	12.0 (0.472)	± 0.3 (±0.012)	0.4 (0.016)	± 0.1 (±0.004)	3.1 (0.122)	± 0.1 (±0.004)
SPH6060□□□□ETK	6.3 (0.248)	± 0.1 (±0.004)	6.3 (0.248)	± 0.1 (±0.004)	8.0 (0.315)	± 0.1 (±0.004)	5.5 (0.217)	± 0.1 (±0.004)	12.0 (0.472)	± 0.3 (±0.012)	0.4 (0.016)	± 0.1 (±0.004)	3.1 (0.122)	± 0.1 (±0.004)
SPN6060□□□□ETP	6.3 (0.248)	± 0.1 (±0.004)	6.3 (0.248)	± 0.1 (±0.004)	8.0 (0.315)	± 0.1 (±0.004)	5.5 (0.217)	± 0.1 (±0.004)	12.0 (0.472)	± 0.3 (±0.012)	0.4 (0.016)	± 0.1 (±0.004)	4.7 (0.185)	± 0.1 (±0.004)
SPH6060□□□□ETP	6.3 (0.248)	± 0.1 (±0.004)	6.3 (0.248)	± 0.1 (±0.004)	8.0 (0.315)	± 0.1 (±0.004)	5.5 (0.217)	± 0.1 (±0.004)	12.0 (0.472)	± 0.3 (±0.012)	0.4 (0.016)	± 0.1 (±0.004)	4.7 (0.185)	± 0.1 (±0.004)
SPN8080□□□□ETL	8.3 (0.327)	± 0.1 (±0.004)	8.3 (0.327)	± 0.1 (±0.004)	12.0 (0.472)	± 0.1 (±0.004)	7.5 (0.295)	± 0.1 (±0.004)	16.0 (0.630)	± 0.3 (±0.012)	0.5 (0.020)	± 0.1 (±0.004)	3.4 (0.134)	± 0.1 (±0.004)
SPN8080□□□□ETN	8.3 (0.327)	± 0.1 (±0.004)	8.3 (0.327)	± 0.1 (±0.004)	12.0 (0.472)	± 0.1 (±0.004)	7.5 (0.295)	± 0.1 (±0.004)	16.0 (0.630)	± 0.3 (±0.012)	0.5 (0.020)	± 0.1 (±0.004)	4.5 (0.177)	± 0.1 (±0.004)
SPH8080□□□□ETN	8.3 (0.327)	± 0.1 (±0.004)	8.3 (0.327)	± 0.1 (±0.004)	12.0 (0.472)	± 0.1 (±0.004)	7.5 (0.295)	± 0.1 (±0.004)	16.0 (0.630)	± 0.3 (±0.012)	0.5 (0.020)	± 0.1 (±0.004)	4.5 (0.177)	± 0.1 (±0.004)

Unit : mm(inch)

Reel Specifications

● Reel 7"

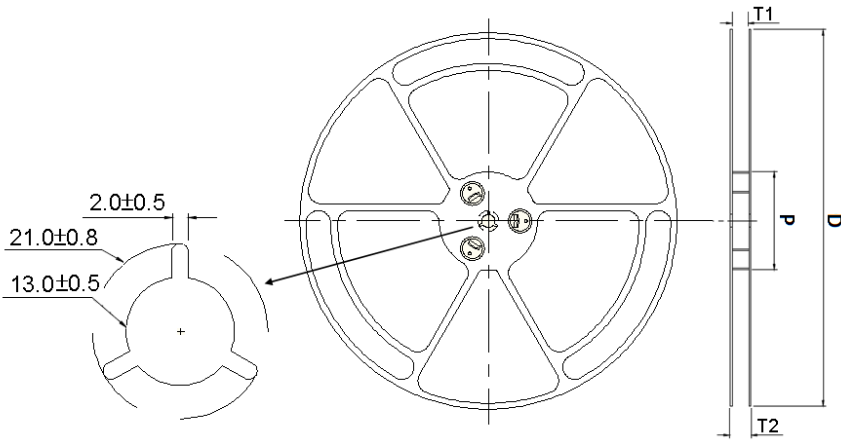

Code	D	P
Dimensions	180 ± 1.5	62.0 ± 1.5

● Reel 13"

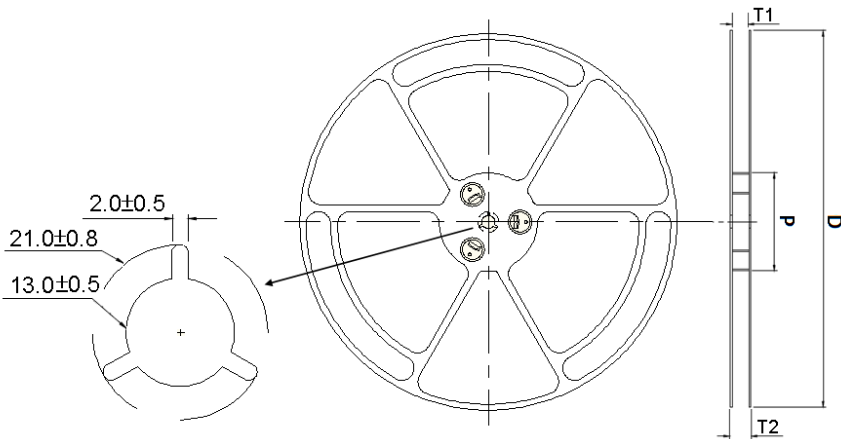

Code	D	P
Dimensions	330 ± 1.5	100 ± 1.5

Assembly Inductors (SPI Series)

Product Range

DARFON Item	Dimensions (mm) max	Inductance range				
		0.1uH	1uH	10uH	100uH	1mH
SPIRI73	7.5*7.5*3.5			10uH		1mH
SPIRI74	7.5*7.5*4.5			10uH		1mH
SPIRI124	12.5*12.5*4.5		3.9uH		330uH	
SPIRI125	12.5*12.5*6.2			10uH		1mH
SPIRI127	12.5*12.5*8.0		2.4uH		47uH	
SPIRR6025	6.2*6.2*2.7		4.7uH		100uH	
SPIRR6028	6.2*6.2*3.0		4.7uH		100uH	
SPIRR7028	7.2*7.2*3.0		3.3uH		47uH	
SPIRR7032	7.2*7.2*3.4		3.3uH			1mH
SPIRR7045	7.2*7.2*4.8		3.3uH			1mH
SPIRR1045	10.4*10.4*4.8			10uH		1.5m
SPIRR1255	12.8*12.8*5.8		6.0uH			1.5mH
SPIRR1265	12.8*12.8*6.85		2.0uH		220uH	
SPIRR1275	12.8*12.8*7.85		1.2uH		220uH	
SPIRH3D16	4.3*4.3*2.0		1.5uH		33uH	
SPIRH4D18	5.2*5.2*2.0		1.0uH		39uH	
SPIRH4D28	5.2*5.2*3.0		1.2uH		180uH	
SPIRH5D18	6.2*6.2*2.1		4.1uH		100uH	
SPIRH5D28	6.2*6.2*3.0		2.6uH		100uH	
SPIRH6D18	7.1*7.1*1.9		3.3uH		10uH	
SPIRH6D28	7.2*7.2*3.0		3.0uH		100uH	
SPIRH6D38	7.2*7.2*4.0		3.3uH		100uH	
SPIRH103R	10.3*10.5*3.1		0.8uH		470uH	
SPIRH104R	10.3*10.5*4.0		1.5uH		330uH	
SPIRD0715	7.1*7.1*1.5		3.3uH		47uH	
SPIRD0728	7.5*7.5*2.8		2.2uH		68uH	
SPIRD1015	10.3*10.3*1.5		2.7uH		47uH	
SPIRD1024	10.3*10.3*2.5		3.9uH		33uH	

■ Standard External Dimensions

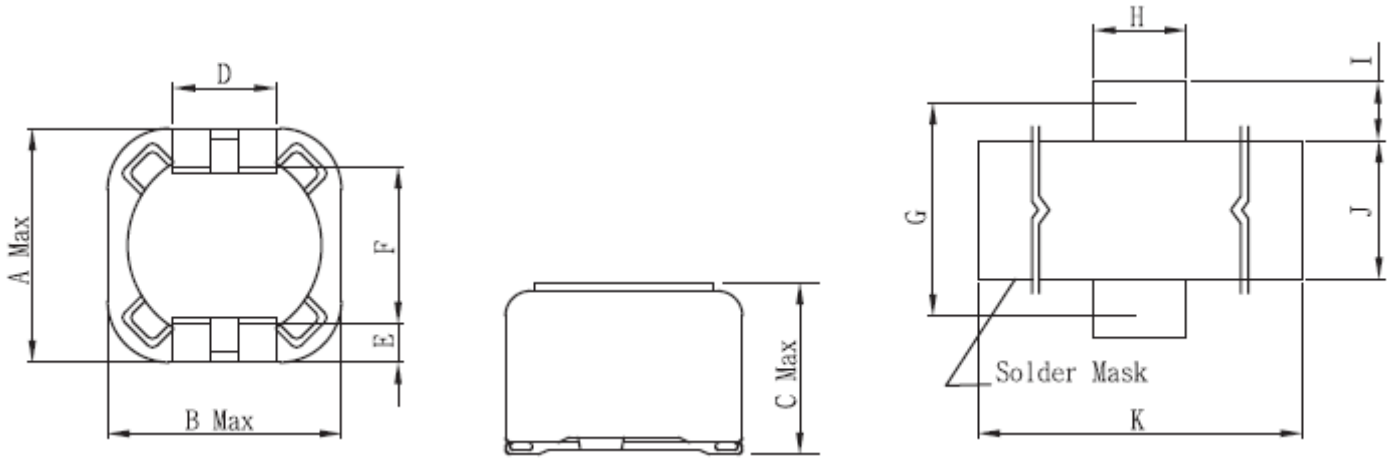

Unit: Inch / mm

Part No	A	B	C	D	E	F	G	H	I	J	K
SPIR173	0.295 max	0.295 max	0.138 max	0.079	0.043	0.200	0.248	0.118	0.075	0.177	0.413
	7.50 max	7.50 max	3.5 max	2.00	1.10	5.08	6.30	3.00	1.91	4.50	10.50
SPIR174	0.295 max	0.295 max	0.177 max	0.079	0.043	0.200	0.248	0.118	0.075	0.177	0.413
	7.50 max	7.50 max	4.50 max	2.00	1.10	5.08	6.30	3.00	1.91	4.50	10.50

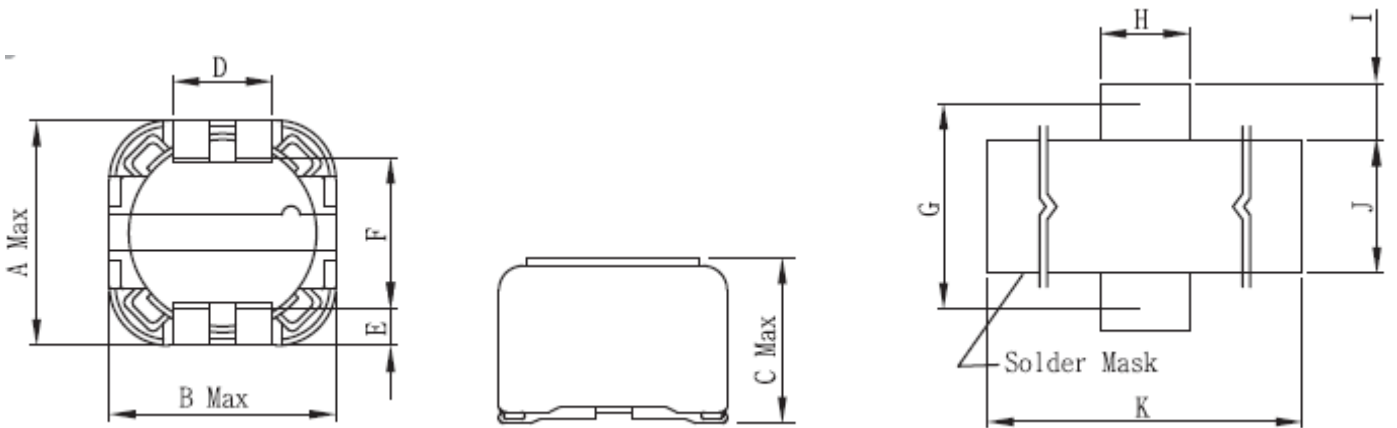

Unit: Inch / mm

Part No	A	B	C	D	E	F	G	H	I	J	K
SPIR124	0.492 max	0.492 max	0.177 max	0.197	0.079	0.299	0.393	0.236	0.118	0.276	0.709
	12.50 max	12.50 max	4.50 max	5.00	2.00	7.60	10.00	6.00	3.00	7.00	18.00
SPIR125	0.492 max	0.492 max	0.244 max	0.197	0.079	0.299	0.393	0.236	0.118	0.276	0.709
	12.50 max	12.50 max	6.20 max	5.00	2.00	7.60	10.00	6.00	3.00	7.00	18.00
SPIR127	0.492 max	0.492 max	0.315 max	0.197	0.079	0.299	0.393	0.236	0.118	0.276	0.709
	12.50 max	12.50 max	8.00 max	5.00	2.00	7.60	10.00	6.00	3.00	7.00	18.00

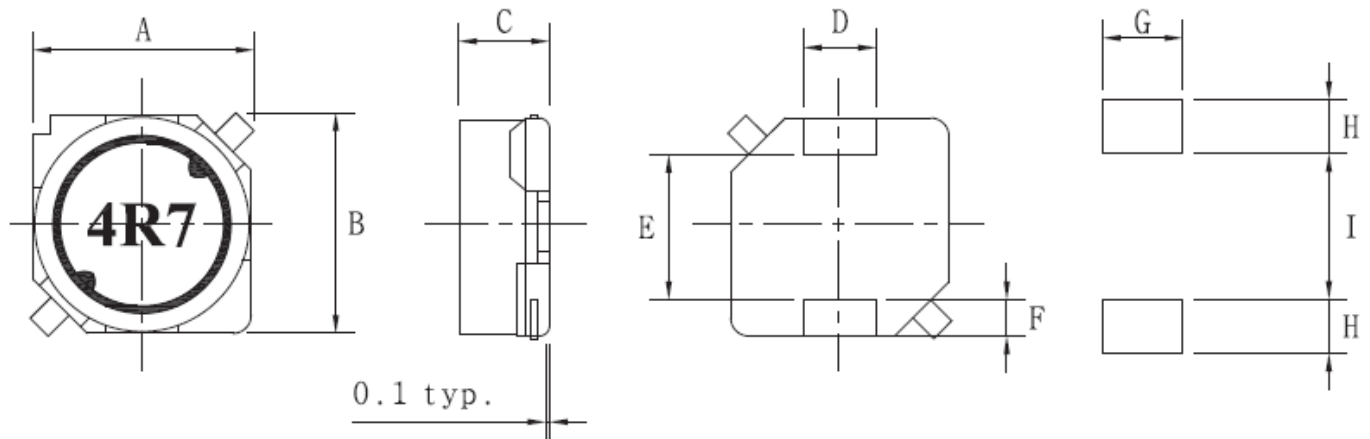

Unit: Inch / mm

Part No	A	B	C	D	E	F	G	H	I
SPIRR6025	0.236±0.079 6.0±0.2	0.236±0.079 6.0±0.2	0.099±0.0079 2.5±0.2	0.079±0.0040 2.0±0.1	0.118 typ 3.0 typ	0.059 typ 1.5 typ	0.0866 2.2	0.079 2.0	0.103 2.6
SPIRR6028	0.236±0.079 6.0±0.2	0.236±0.079 6.0±0.2	0.110±0.0079 2.5±0.2	0.079±0.0040 2.0±0.1	0.118 typ 3.0 typ	0.059 typ 1.5 typ	0.0866 2.2	0.079 2.0	0.103 2.6
SPIRR7028	0.276±0.079 7.0±0.2	0.276±0.079 7.0±0.2	0.110±0.0079 2.5±0.2	0.079±0.0040 2.0±0.1	0.193 typ 4.0 typ	0.059 typ 1.5 typ	0.0866 2.2	0.079 2.0	0.103 3.6
SPIRR7032	0.276±0.079 7.0±0.2	0.276±0.079 7.0±0.2	0.126±0.0079 3.2±0.2	0.079±0.0040 2.0±0.1	0.193 typ 4.0 typ	0.059 typ 1.5 typ	0.0866 2.2	0.079 2.0	0.142 3.6
SPIRR7045	0.276±0.079 7.0±0.2	0.276±0.079 7.0±0.2	0.177±0.118 4.5±0.3	0.079±0.0040 2.0±0.1	0.193 typ 4.0 typ	0.059 typ 1.5 typ	0.0866 2.2	0.079 2.0	0.142 3.6
SPIRR1045	0.398±0.0118 10.1±0.3	0.398±0.0118 10.1±0.3	0.177±0.118 4.5±0.3	0.118±0.0040 3.0±0.1	0.236±0.0079 6.0±0.2	0.079±0.0059 2.0±0.15	0.126 3.2	0.099 2.5	0.322 8.2
SPIRR1255	0.492±0.118 10.1±0.3	0.492±0.118 10.1±0.3	0.217±0.0118 5.5±0.3	0.118±0.0040 3.0±0.1	0.339±0.0118 8.6±0.3	0.079±0.0059 2.0±0.15	0.126 3.2	0.099 2.5	0.322 8.2
SPIRR1265	0.492±0.118 10.1±0.3	0.492±0.118 10.1±0.3	0.256±0.0138 6.5±0.35	0.118±0.0040 3.0±0.1	0.339±0.0118 8.6±0.3	0.079±0.0059 2.0±0.15	0.126 3.2	0.099 2.5	0.322 8.2
SPIRR1275	0.492±0.118 10.1±0.3	0.492±0.118 10.1±0.3	0.295±0.0138 7.5±0.35	0.118±0.0040 3.0±0.1	0.339±0.0118 8.6±0.3	0.079±0.0059 2.0±0.15	0.126 3.2	0.099 2.5	0.322 8.2

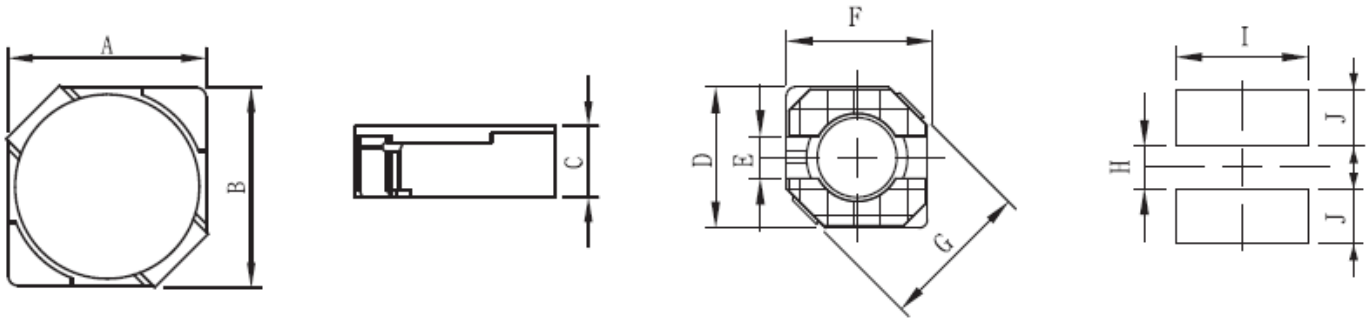

Unit: Inch / mm

Part No	A	B	C	D	E	F	G	H	I	J
SPIRH3D16	0.150±0.012 3.8±0.5	0.150±0.012 3.8±0.5	0.071±0.008 1.8±0.2	0.150 3.8	0.044 1.1	0.150 3.8	0.196 max 5.0 max	0.044 1.1	0.181 4.6	0.067 1.7
SPIRH4D18	0.185±0.012 4.7±0.5	0.185±0.012 4.7±0.5	0.079 max 2.0 max	0.177 4.5	0.059 1.5	0.177 4.5	0.272 max 6.9 max	0.059 1.5	0.209 5.3	0.075 1.9
SPIRH4D28	0.185±0.12 4.7±0.5	0.0185±0.012 4.7±0.5	0.119 max 3.0 max	0.177 4.5	0.059 1.5	0.177 4.5	0.272 max 6.9 max	0.059 1.5	0.209 5.3	0.075 1.9
SPIRH5D18	0.225±0.12 5.7±0.5	0.225±0.12 5.7±0.5	0.083 max 2.1 max	0.217 5.5	0.079 2.0	0.217 5.5	0.323 max 8.2 max	0.079 2.0	0.248 6.3	0.085 2.15
SPIRH5D28	0.225±0.12 5.7±0.5	0.225±0.12 5.7±0.5	0.119 max 3.0 max	0.217 5.5	0.079 2.0	0.217 5.5	0.323 max 8.2 max	0.079 2.0	0.248 6.3	0.085 2.15
SPIRH6D18	0.264±0.158 6.7±0.4	0.264±0.158 6.7±0.4	0.075 max 1.9 max	0.256 6.5	0.079 2.0	0.256 6.5	0.375 max 9.5 max	0.079 2.0	0.288 7.3	0.105 2.65
SPIRH6D28	0.264±0.158 6.7±0.4	0.264±0.158 6.7±0.4	0.119 max 3.0 max	0.256 6.5	0.079 2.0	0.256 6.5	0.375 max 9.5 max	0.079 2.0	0.288 7.3	0.105 2.65
SPIRH6D38	0.264±0.158 6.7±0.4	0.264±0.158 6.7±0.4	0.158 max 4.0 max	0.256 6.5	0.079 2.0	0.256 6.5	0.375 max 9.5 max	0.079 2.0	0.288 7.3	0.105 2.65

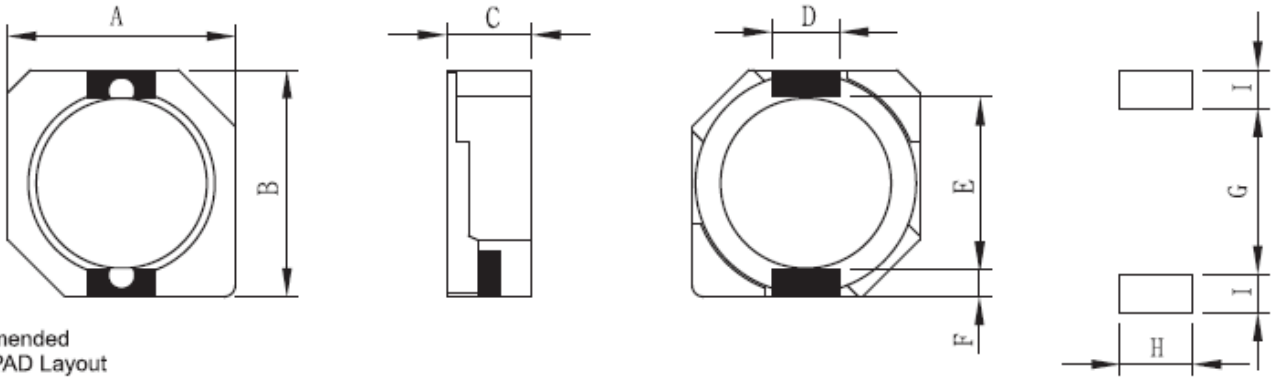

Recommended Solder PAD Layout

Unit: Inch / mm

Part No	A	B	C	D	E	F	G	H	I
SPIRH103R	0.398 max 10.3 max	0.414 max 10.5 max	0.122 max 3.1 max	0.119±0.004 3.0±0.1	0.303±0.012 7.7±0.3	0.048±0.006 1.2±0.15	0.288 7.3	0.126 3.2	0.63 1.6
SPIRH104R	0.398 max 10.3 max	0.414 max 10.5 max	0.150±0.008 3.8±0.2	0.119±0.004 3.0±0.1	0.303±0.012 7.7±0.3	0.048±0.006 1.2±0.15	0.288 7.3	0.126 3.2	0.63 1.6

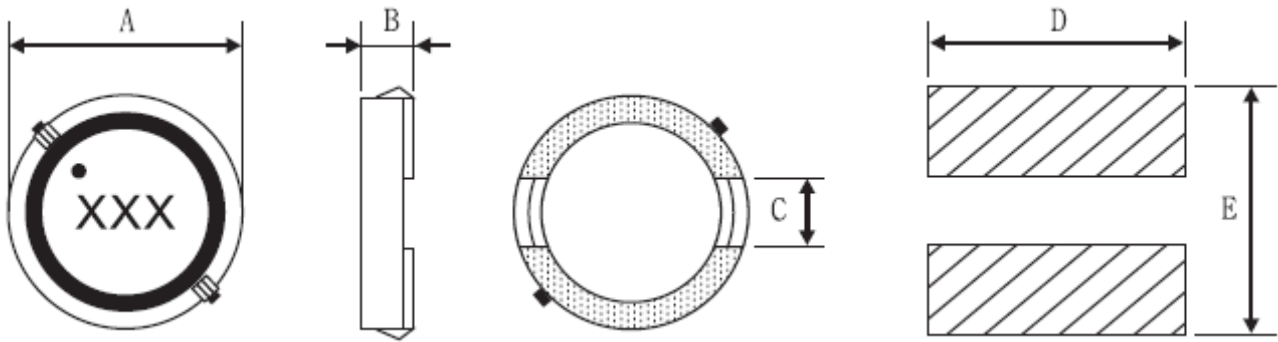

Unit: Inch / mm

Part No	A	B	C	D	E
SPIRD7015	0.271±0.157 6.9±0.4	0.059 max 1.5 max	0.079 2.0	0.288 7.3	0.288 7.3
SPIRD7028	0.276±0.020 7.0±0.5	0.110 max 2.8 max	0.079 2.0	0.288 7.3	0.288 7.3

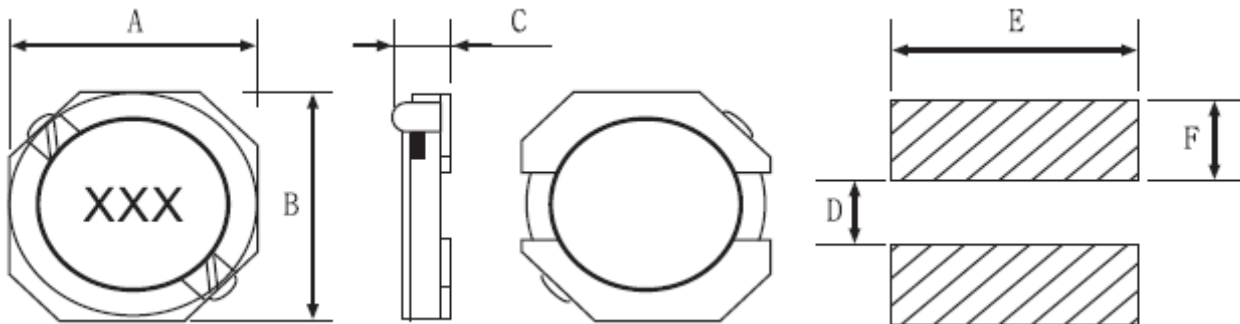

Unit: Inch / mm

Part No	A	B	C	D	E	F
SPIRD1015	0.406 max 10.3 max	0.406 max 10.3 max	0.059 max 1.5 max	0.119 3.0	0.410 10.4	0.146 3.7
SPIRD1024	0.406 max 10.3 max	0.406 max 10.3 max	0.099 max 2.5 max	0.119 3.0	0.410 10.4	0.146 3.7

■ Part Numbers & Characteristic (SPI Series)

● SPIRI Series

DARFON P/N	Inductance L (uH)	Tolerance	Rated current (A)	DC Resistance (Ω) ± 20%	Marking	Measuring Condition
SPIRI73						
SPIRI73100M	10	± 20%	1.68	0.072	---	100KHz, 1V
SPIRI73120M	12		1.52	0.098	---	
SPIRI73150M	15		1.33	0.130	---	
SPIRI73180M	18		1.20	0.140	---	
SPIRI73220M	22		1.07	0.190	---	
SPIRI73270M	27		0.96	0.210	---	
SPIRI73330M	33		0.91	0.240	---	
SPIRI73390M	39		0.77	0.320	---	
SPIRI73470M	47		0.76	0.360	---	
SPIRI73560M	56		0.68	0.470	---	
SPIRI73680M	68		0.61	0.520	---	
SPIRI73820M	82		0.57	0.690	---	
SPIRI73101M	100		0.50	0.790	---	
SPIRI73121M	120		0.49	0.890	---	
SPIRI73151M	150		0.43	1.270	---	
SPIRI73181M	180		0.39	1.450	---	
SPIRI73221M	220		0.35	1.650	---	
SPIRI73271M	270		0.32	2.310	---	
SPIRI73331M	330		0.28	2.620	---	
SPIRI73391M	390		0.26	2.940	---	
SPIRI73471M	470		0.24	4.180	---	
SPIRI73561M	560		0.22	4.670	---	
SPIRI73681M	680		0.19	5.730	---	
SPIRI73821M	820	0.18	6.540	---		
SPIRI73102M	1000	0.16	9.440	---		

DARFON Inductors – SPI (Assembly)

DARFON P/N	Inductance L (uH)	Tolerance	Rated current (A)	DC Resistance (Ω) ± 20%	Marking	Measuring Condition
SPIR174						
SPIR174100M	10	± 20%	1.84	0.072	---	100KHz, 1V
SPIR174120M	12		1.71	0.098	---	
SPIR174150M	15		1.47	0.130	---	
SPIR174180M	18		1.31	0.140	---	
SPIR174220M	22		1.23	0.190	---	
SPIR174270M	27		1.12	0.210	---	
SPIR174330M	33		0.96	0.240	---	
SPIR174390M	39		0.91	0.320	---	
SPIR174470M	47		0.88	0.360	---	
SPIR174560M	56		0.75	0.470	---	
SPIR174680M	68		0.69	0.520	---	
SPIR174820M	82		0.61	0.690	---	
SPIR174101M	100		0.60	0.790	---	
SPIR174121M	120		0.52	0.890	---	
SPIR174151M	150		0.46	1.270	---	
SPIR174181M	180		0.42	1.450	---	
SPIR174221M	220		0.36	1.650	---	
SPIR174271M	270		0.34	2.310	---	
SPIR174331M	330		0.32	2.620	---	
SPIR174391M	390		0.29	2.940	---	
SPIR174561M	560	0.23	4.670	---		
SPIR174681M	680	0.22	5.730	---		
SPIR174821M	820	0.20	6.540	---		
SPIR174102M	1000	0.18	9.440	---		

DARFON Inductors – SPI (Assembly)

DARFON P/N	Inductance L (uH)	Tolerance	Rated current (A)	DC Resistance (Ω) ± 20%	Marking	Measuring Condition
SPIRI124						
SPIRI1243R9M	3.9	± 20%	6.50	0.015	---	100KHz, 1V
SPIRI1244R7M	4.7		5.70	0.018	---	
SPIRI1246R8M	6.8		4.90	0.023	---	
SPIRI124100M	10		4.50	0.028	---	
SPIRI124120M	12		4.00	0.038	---	
SPIRI124150M	15		3.20	0.050	---	
SPIRI124180M	18		3.10	0.057	---	
SPIRI124220M	22		2.90	0.066	---	
SPIRI124270M	27		2.80	0.080	---	
SPIRI124330M	33		2.70	0.097	---	
SPIRI124390M	39		2.10	0.132	---	
SPIRI124470M	47		1.90	0.150	---	
SPIRI124560M	56		1.80	0.190	---	
SPIRI124680M	68		1.50	0.220	---	
SPIRI124820M	82		1.30	0.260	---	
SPIRI124101M	100		1.20	0.308	---	
SPIRI124121M	120		1.10	0.380	---	
SPIRI124151M	150		0.95	0.530	---	
SPIRI124181M	180		0.85	0.620	---	
SPIRI124221M	220		0.80	0.700	---	
SPIRI124271M	270	0.60	0.876	---		
SPIRI124331M	330	0.50	0.990	---		

DARFON P/N	Inductance L (uH)	Tolerance	Rated current (A)	DC Resistance (Ω) ± 20%	Marking	Measuring Condition
SPIRI125						
SPIRI125100M	10	± 20%	4.00	0.025	---	100KHz, 1V
SPIRI125120M	12		3.50	0.027	---	
SPIRI125150M	15		3.30	0.030	---	
SPIRI125180M	18		3.00	0.038	---	
SPIRI125220M	22		2.80	0.045	---	
SPIRI125270M	27		2.30	0.055	---	
SPIRI125330M	33		2.10	0.063	---	
SPIRI125390M	39		2.00	0.075	---	
SPIRI125470M	47		1.80	0.085	---	
SPIRI125560M	56		1.70	0.110	---	
SPIRI125680M	68		1.50	0.120	---	
SPIRI125820M	82		1.40	0.140	---	
SPIRI125101M	100		1.30	0.165	---	
SPIRI125121M	120		1.10	0.195	---	
SPIRI125151M	150		1.00	0.250	---	
SPIRI125181M	180		0.90	0.290	---	
SPIRI125221M	220		0.80	0.400	---	
SPIRI125271M	270		0.75	0.460	---	
SPIRI125331M	330		0.68	0.510	---	
SPIRI125391M	390		0.65	0.690	---	
SPIRI125471M	470	0.58	0.770	---		
SPIRI125561M	560	0.54	0.880	---		
SPIRI125681M	680	0.48	1.200	---		
SPIRI125821M	820	0.43	1.340	---		
SPIRI125102M	1000	0.40	1.530	---		
SPIRI127						
SPIRI1272R4M	2.4	± 20%	8	0.012	---	100KHz, 1V
SPIRI1274R7M	4.7		6.80	0.016	---	
SPIRI1277R6M	7.6		5.90	0.020	---	
SPIRI127100M	10		5.40	0.022	---	
SPIRI127120M	12		4.90	0.025	---	
SPIRI127150M	15		4.50	0.027	---	
SPIRI127180M	18		3.90	0.039	---	
SPIRI127220M	22		3.60	0.043	---	
SPIRI127270M	27		3.40	0.046	---	
SPIRI127330M	33		3.00	0.065	---	
SPIRI127390M	39		2.75	0.073	---	
SPIRI127470M	47		2.50	0.100	---	

● **SPIRR Series**

DARFON P/N	Inductance L (uH)	Tolerance	Rated current (A)	DC Resistance (Ω) ± 20%	Marking	Measuring Condition
SPIRR6025						
SPIRR60254R7M	4.7	± 20%	1.50	0.050	---	100KHz, 1V
SPIRR60256R8M	6.8		1.30	0.080	---	
SPIRR6025100M	10		1.00	0.098	---	
SPIRR6025150M	15		0.88	0.140	---	
SPIRR6025220M	22		0.73	0.208	---	
SPIRR6025330M	33		0.59	0.310	---	
SPIRR6025470M	47		0.48	0.390	---	
SPIRR6025680M	68		0.42	0.540	---	
SPIRR6025101M	100		0.33	0.810	---	
SPIRR6028						
SPIRR6028M	3.3	± 20%	1.60	0.050	---	100KHz, 1V
SPIRR6028M	6.8		1.50	0.073	---	
SPIRR6028M	10		1.30	0.098	---	
SPIRR6028M	15		1.00	0.128	---	
SPIRR6028M	22		0.77	0.172	---	
SPIRR6028M	33		0.69	0.290	---	
SPIRR6028M	47		0.59	0.420	---	
SPIRR6028M	68		0.50	0.533	---	
SPIRR6028M	100		0.42	0.730	---	
SPIRR7028						
SPIRR70283R3M	3.3	± 20%	1.60	0.045	---	100KHz, 1V
SPIRR70284R7M	4.7		1.50	0.054	---	
SPIRR70286R8M	6.8		1.30	0.071	---	
SPIRR7028100M	10		1.10	0.100	---	
SPIRR7028150M	15		0.88	0.156	---	
SPIRR7028220M	22		0.75	0.220	---	
SPIRR7028330M	33		0.65	0.290	---	
SPIRR7028470M	47		0.54	0.410	---	

DARFON P/N	Inductance L (uH)	Tolerance	Rated current (A)	DC Resistance (Ω) ± 20%	Marking	Measuring Condition
SPIRR7032						
SPIRR70323R3M	3.3	± 20%	1.90	0.028	---	100KHz, 1V
SPIRR70324R7M	4.7		1.70	0.044	---	
SPIRR70326R8M	6.8		1.60	0.050	---	
SPIRR7032100M	10		1.40	0.064	---	
SPIRR7032150M	15		1.10	0.090	---	
SPIRR7032220M	22		0.96	0.132	---	
SPIRR7032330M	33		0.75	0.192	---	
SPIRR7032M470	47		0.67	0.290	---	
SPIRR7032680M	68		0.59	0.372	---	
SPIRR7032101M	100		0.45	0.540	---	
SPIRR7032151M	150		0.37	0.780	---	
SPIRR7032221M	220		0.29	1.260	---	
SPIRR7032331M	330		0.22	2.000	---	
SPIRR7032471M	470		0.20	2.460	---	
SPIRR7032681M	680		0.16	3.780	---	
SPIRR7032102M	1000		0.13	5.740	---	
SPIRR7045						
SPIRR70453R3M	3.3	± 20%	2.30	0.024	---	100KHz, 1V
SPIRR70454R7M	4.7		2.00	0.036	---	
SPIRR70456R8M	6.8		1.70	0.045	---	
SPIRR7045100M	10		1.30	0.047	---	
SPIRR7045150M	15		1.10	0.063	---	
SPIRR7045220M	22		0.90	0.075	---	
SPIRR7045330M	33		0.82	0.120	---	
SPIRR7045470M	47		0.75	0.150	---	
SPIRR7045680M	68		0.60	0.210	---	
SPIRR7045101M	100		0.50	0.300	---	
SPIRR7045151M	150		0.40	0.410	---	
SPIRR7045221M	220		0.33	0.624	---	
SPIRR7045331M	330		0.25	0.890	---	
SPIRR7045471M	470		0.22	1.260	---	
SPIRR7045681M	680		0.20	1.780	---	
SPIRR7045102M	1000		0.14	2.740	---	

DARFON Inductors – SPI (Assembly)

DARFON P/N	Inductance L (uH)	Tolerance	Rated current (A)	DC Resistance (Ω) ± 20%	Marking	Measuring Condition
SPIRR1045						
SPIRR1045100M	10	± 20%	2.5	0.044	---	100KHz, 1V
SPIRR1045150M	15		2.2	0.057	---	
SPIRR1045220M	22		1.90	0.071	---	
SPIRR1045330M	33		1.60	0.100	---	
SPIRR1045470M	47		1.40	0.120	---	
SPIRR1045680M	68		1.20	0.170	---	
SPIRR1045101M	100		1.00	0.240	---	
SPIRR1045151M	150		0.79	0.420	---	
SPIRR1045221M	220		0.65	0.570	---	
SPIRR1045331M	330		0.54	0.820	---	
SPIRR1045471M	470		0.47	1.240	---	
SPIRR1045681M	680		0.38	1.920	---	
SPIRR1045102M	1000		0.29	3.360	---	
SPIRR1045152M	1500		0.22	4.080	---	
SPIRR1255						
SPIRR12556R0M	6.0	± 20%	3.60	0.020		100KHz, 1V
SPIRR1255100M	10		3.40	0.026		
SPIRR1255150M	15		2.80	0.032		
SPIRR1255220M	22		2.30	0.041		
SPIRR1255330M	33		1.90	0.050		
SPIRR1255470M	47		1.60	0.075		
SPIRR1255680M	68		1.30	0.100		
SPIRR1255101M	100		1.10	0.140		
SPIRR1255151M	150		0.88	0.230		
SPIRR1255221M	220		0.72	0.330		
SPIRR1255331M	330		0.59	0.500		
SPIRR1255471M	470		0.49	0.630		
SPIRR1255681M	680		0.43	0.920		
SPIRR1255102M	1000		0.34	1.350		
SPIRR1255152M	1500	0.29	2.080			

DARFON P/N	Inductance L (uH)	Tolerance	Rated current (A)	DC Resistance (Ω) ± 20%	Marking	Measuring Condition
SPIRR1265						
SPIRR12652R0M	2.0	± 20%	6.20	0.014	---	100KHz, 1V
SPIRR12654R2M	4.2		5.50	0.018	---	
SPIRR12657R0M	7.0		5.00	0.022	---	
SPIRR1265100M	10		4.80	0.025	---	
SPIRR1265150M	15		4.20	0.029	---	
SPIRR1265220M	22		3.50	0.038	---	
SPIRR1265330M	33		2.80	0.049	---	
SPIRR1265470M	47		2.40	0.070	---	
SPIRR1265680M	68		2.00	0.095	---	
SPIRR1265101M	100		1.60	0.150	---	
SPIRR1265221M	220		1.00	0.330	---	
SPIRR1275						
SPIRR12751R2M	1.2	± 20%	8.20	0.009		100KHz, 1V
SPIRR12752R7M	2.7		7.00	0.012		
SPIRR12753R9M	3.9		6.70	0.013		
SPIRR12755R6M	5.6		6.30	0.014		
SPIRR12756R8M	6.8		5.90	0.016		
SPIRR1275100M	10		5.40	0.019		
SPIRR1275150M	15		4.70	0.022		
SPIRR1275220M	22		4.00	0.032		
SPIRR1275330M	33		3.20	0.048		
SPIRR1275470M	47		2.70	0.064		
SPIRR1275680M	68		2.00	0.094		
SPIRR1275101M	100		1.90	0.150		
SPIRR1275151M	150		1.50	0.210		
SPIRR1275221M	220		1.30	0.310		

● **SPIRH Series**

DARFON P/N	Inductance L (uH)	Tolerance	Rated current (A)	DC Resistance (Ω) ± 20%	Marking	Measuring Condition
SPIRH3D16						
SPIRH3D161R5M	1.5	± 20%	1.55	0.052	---	100KHz, 1V
SPIRH3D162R2M	2.2		1.20	0.072	---	
SPIRH3D163R3M	3.3		1.10	0.085	---	
SPIRH3D164R7M	4.7		0.90	0.105	---	
SPIRH3D166R8M	6.8		0.73	0.170	---	
SPIRH3D16100M	10		0.55	0.210	---	
SPIRH3D16150M	15		0.45	0.295	---	
SPIRH3D16220M	22		0.40	0.430	---	
SPIRH3D16330M	33		0.32	0.675	---	
SPIRH4D18						
SPIRH4D181R0M	1.0	± 20%	1.72	0.045	---	100KHz, 1V
SPIRH4D182R2M	2.2		1.32	0.060	---	
SPIRH4D182R7M	2.7		1.28	0.070	---	
SPIRH4D183R3M	3.3		1.04	0.085	---	
SPIRH4D183R9M	3.9		0.88	0.110	---	
SPIRH4D184R7M	4.7		0.84	0.128	---	
SPIRH4D185R6M	5.6		0.80	0.145	---	
SPIRH4D186R8M	6.8		0.76	0.158	---	
SPIRH4D188R2M	8.2		0.68	0.185	---	
SPIRH4D18100M	10		0.61	0.200	---	
SPIRH4D18120M	12		0.56	0.210	---	
SPIRH4D18150M	15		0.50	0.240	---	
SPIRH4D18180M	18		0.48	0.338	---	
SPIRH4D18220M	22		0.41	0.397	---	
SPIRH4D18270M	27		0.35	0.441	---	
SPIRH4D18330M	33		0.32	0.694	---	
SPIRH4D18390M	39		0.30	0.709	---	

DARFON P/N	Inductance L (uH)	Tolerance	Rated current (A)	DC Resistance (Ω) ± 20%	Marking	Measuring Condition
SPIRH4D28						
SPIRH4D281R2M	1.2	± 20%	2.56	0.0236	---	100KHz, 1V
SPIRH4D281R8M	1.8		2.20	0.0275	---	
SPIRH4D282R2M	2.2		2.04	0.0313	---	
SPIRH4D282R7M	2.7		1.60	0.0433	---	
SPIRH4D283R3M	3.3		1.57	0.0492	---	
SPIRH4D283R9M	3.9		1.44	0.0648	---	
SPIRH4D284R7M	4.7		1.32	0.0720	---	
SPIRH4D285R6M	5.6		1.17	0.1009	---	
SPIRH4D286R8M	6.8		1.12	0.1089	---	
SPIRH4D288R2M	8.2		1.04	0.1175	---	
SPIRH4D28100M	10		1.00	0.1283	---	
SPIRH4D28120M	12		0.84	0.1316	---	
SPIRH4D28150M	15		0.76	0.1490	---	
SPIRH4D28180M	18		0.72	0.1660	---	
SPIRH4D28220M	22		0.70	0.2350	---	
SPIRH4D28270M	27		0.58	0.2610	---	
SPIRH4D28330M	33		0.56	0.3780	---	
SPIRH4D28390M	39		0.50	0.3837	---	
SPIRH4D28470M	47		0.48	0.5870	---	
SPIRH4D28560M	56		0.41	0.6245	---	
SPIRH4D28680M	68	0.35	0.6990	---		
SPIRH4D28820M	82	0.32	0.9148	---		
SPIRH4D28101M	100	0.29	1.020	---		
SPIRH4D28121M	120	0.27	1.270	---		
SPIRH4D28151M	150	0.24	1.350	---		
SPIRH4D28181M	180	0.22	1.540	---		
SPIRH5D18						
SPIRH5D184R1M	4.1	± 20%	1.95	0.057	---	100KHz, 1V
SPIRH5D185R4M	5.4		1.60	0.076	---	
SPIRH5D186R2M	6.2		1.40	0.096	---	
SPIRH5D188R9M	8.9		1.25	0.116	---	
SPIRH5D18100M	10		1.20	0.124	---	
SPIRH5D18120M	12		1.10	0.153	---	
SPIRH5D18150M	15		0.97	0.196	---	
SPIRH5D18180M	18		0.85	0.210	---	
SPIRH5D18220M	22		0.80	0.290	---	
SPIRH5D18270M	27		0.75	0.330	---	
SPIRH5D18330M	33		0.65	0.386	---	
SPIRH5D18390M	39		0.57	0.520	---	
SPIRH5D18470M	47		0.54	0.595	---	
SPIRH5D18560M	56		0.50	0.665	---	
SPIRH5D18680M	68		0.43	0.840	---	
SPIRH5D18820M	82		0.41	0.978	---	
SPIRH5D18101M	100		0.36	1.200	---	

DARFON P/N	Inductance L (uH)	Tolerance	Rated current (A)	DC Resistance (Ω) ± 20%	Marking	Measuring Condition
SPIRH5D28						
SPIRH5D282R6M	2.6	± 20%	2.60	0.018	---	100KHz, 1V
SPIRH5D283R0M	3.0		2.40	0.024	---	
SPIRH5D284R2M	4.2		2.20	0.031	---	
SPIRH5D285R3M	5.3		1.90	0.038	---	
SPIRH5D286R2M	6.2		1.80	0.045	---	
SPIRH5D288R2M	8.2		1.60	0.053	---	
SPIRH5D28100M	10		1.30	0.065	---	
SPIRH5D28120M	12		1.20	0.076	---	
SPIRH5D28150M	15		1.10	0.103	---	
SPIRH5D28180M	18		1.00	0.110	---	
SPIRH5D28220M	22		0.90	0.122	---	
SPIRH5D28270M	27		0.85	0.175	---	
SPIRH5D28330M	33		0.75	0.189	---	
SPIRH5D28390M	39		0.70	0.212	---	
SPIRH5D28470M	47		0.62	0.260	---	
SPIRH5D28560M	56		0.58	0.305	---	
SPIRH5D28680M	68		0.52	0.355	---	
SPIRH5D28820M	82		0.46	0.463	---	
SPIRH5D28101M	100	0.42	0.520	---		
SPIRH6D18						
SPIRH6D183R3M	3.3	± 20%	3.00	0.069	---	100KHz, 1V
SPIRH6D184R7M	4.7		2.40	0.075	---	
SPIRH6D186R8M	6.8		2.20	0.106	---	
SPIRH6D18100M	10		1.80	0.150	---	
SPIRH6D28						
SPIRH6D283R0M	3.0	± 20%	3.00	0.024	---	100KHz, 1V
SPIRH6D283R9M	3.9		2.60	0.027	---	
SPIRH6D285R0M	5.0		2.40	0.031	---	
SPIRH6D286R0M	6.0		2.25	0.035	---	
SPIRH6D287R3M	7.3		2.10	0.054	---	
SPIRH6D288R6M	8.6		1.85	0.058	---	
SPIRH6D28100M	10		1.70	0.065	---	
SPIRH6D28120M	12		1.55	0.070	---	
SPIRH6D28150M	15		1.40	0.084	---	
SPIRH6D28180M	18		1.32	0.095	---	
SPIRH6D28220M	22		1.20	0.128	---	
SPIRH6D28270M	27		1.05	0.142	---	
SPIRH6D28330M	33		0.97	0.165	---	
SPIRH6D28390M	39		0.86	0.210	---	
SPIRH6D28470M	47		0.80	0.238	---	
SPIRH6D28560M	56		0.73	0.277	---	
SPIRH6D28680M	68		0.65	0.304	---	
SPIRH6D28820M	82		0.60	0.390	---	
SPIRH6D28101M	100	0.54	0.535	---		

DARFON P/N	Inductance L (uH)	Tolerance	Rated current (A)	DC Resistance (Ω) ± 20%	Marking	Measuring Condition
SPIRH6D38						
SPIRH6D383R3M	3.3	± 20%	3.50	0.020	---	100KHz, 1V
SPIRH6D385R0M	5.0		2.90	0.024	---	
SPIRH6D386R0M	6.0		2.50	0.027	---	
SPIRH6D387R3M	7.3		2.30	0.031	---	
SPIRH6D388R6M	8.6		2.20	0.034	---	
SPIRH6D38100M	10		2.00	0.038	---	
SPIRH6D38120M	12		1.70	0.053	---	
SPIRH6D38150M	15		1.60	0.057	---	
SPIRH6D38180M	18		1.50	0.092	---	
SPIRH6D38220M	22		1.30	0.096	---	
SPIRH6D38270M	27		1.20	0.109	---	
SPIRH6D38330M	33		1.10	0.124	---	
SPIRH6D38390M	39		1.00	0.138	---	
SPIRH6D38470M	47		0.95	0.155	---	
SPIRH6D38560M	56		0.85	0.202	---	
SPIRH6D38680M	68		0.75	0.234	---	
SPIRH6D38820M	82	0.70	0.324	---		
SPIRH6D38101M	100	0.65	0.358	---		
SPIRH103R						
SPIRH103R0R8N	0.8	± 30%	11.2	0.0057	---	100KHz, 1V
SPIRH103R1R5N	1.5		8.00	0.011	---	
SPIRH103R2R2N	2.2		6.70	0.0159	---	
SPIRH103R3R3N	3.3		5.56	0.021	---	
SPIRH103R4R7N	4.7		4.55	0.030	---	
SPIRH103R6R8N	6.8		3.84	0.035	---	
SPIRH103R8R0N	8.0		3.54	0.050	---	
SPIRH103R100N	10		3.18	0.059	---	
SPIRH103R150N	15		2.60	0.091	---	
SPIRH103R220N	22		2.16	0.143	---	
SPIRH103R330N	33		1.74	0.202	---	
SPIRH103R470N	47		1.43	0.299	---	

DARFON Inductors – SPI (Assembly)

DARFON P/N	Inductance L (uH)	Tolerance	Rated current (A)	DC Resistance (Ω) ± 20%	Marking	Measuring Condition
SPIRH104R						
SPIRH104R1R5N	1.5	± 30%	10.0	0.0081	---	100KHz, 1V
SPIRH104R2R5N	2.5		7.50	0.010	---	
SPIRH104R3R8N	3.8		6.00	0.013	---	
SPIRH104R4R7N	4.7		5.50	0.022	---	
SPIRH104R5R2N	5.2		5.50	0.022	---	
SPIRH104R7R0N	7.0		4.80	0.027	---	
SPIRH104R100N	10		4.40	0.035	---	
SPIRH104R150N	15		3.60	0.050	---	
SPIRH104R220N	22		2.90	0.073	---	
SPIRH104R330N	33		2.30	0.093	---	
SPIRH104R470N	47		2.10	0.128	---	
SPIRH104R680N	68		1.50	0.213	---	
SPIRH104R101N	100		1.35	0.304	---	
SPIRH104R151N	150		1.15	0.506	---	
SPIRH104R221N	220		0.92	0.756	---	
SPIRH104R331N	330		0.70	1.090	---	

● **SPIRD Series**

DARFON P/N	Inductance L (uH)	Tolerance	Rated current (A)	DC Resistance (Ω) ± 20%	Marking	Measuring Condition
SPIRD7015						
SPIRD70153R3T	3.3	± 25%	2.10	0.085	---	100KHz, 1V
SPIRD70154R7T	4.7		1.70	0.115	---	
SPIRD70156R8T	6.8		1.45	0.144	---	
SPIRD7015100T	10		1.25	0.225	---	
SPIRD7015150T	15		1.05	0.290	---	
SPIRD7015220T	22		0.85	0.450	---	
SPIRD7015470T	47		0.55	0.850	---	
SPIRD7028						
SPIRD70282R2T	2.2	± 25%	4.00	0.028	---	100KHz, 1V
SPIRD70282R7T	2.7		3.60	0.030	---	
SPIRD70283R3T	3.3		3.20	0.035	---	
SPIRD70284R7T	4.7		2.60	0.045	---	
SPIRD70286R8T	6.8		2.20	0.058	---	
SPIRD7028100T	10		1.80	0.075	---	
SPIRD7028220T	22		1.20	0.180	---	
SPIRD7028470T	47		0.90	0.390	---	
SPIRD7028680T	68		0.80	0.510	---	
SPIRD1015						
SPIRD10152R7T	2.7	± 25%	3.40	0.042	---	100KHz, 1V
SPIRD10153R3T	3.3		3.00	0.057	---	
SPIRD10154R7T	4.7		2.60	0.071	---	
SPIRD10156R8T	6.8		2.10	0.106	---	
SPIRD1015100T	10		1.80	0.140	---	
SPIRD1015220T	22		1.20	0.288	---	
SPIRD1015470T	47		0.80	0.654	---	
SPIRD1024						
SPIRD10243R9T	3.9	± 25%	3.80	0.036	---	100KHz, 1V
SPIRD10244R7T	4.7		3.60	0.039	---	
SPIRD10246R8T	6.8		2.70	0.068	---	
SPIRD1024100T	10		2.60	0.082	---	
SPIRD1024150T	15		1.70	0.120	---	
SPIRD1024220T	22		1.40	0.178	---	
SPIRD1024330T	33		1.20	0.252	---	



Multi-Layer Power Inductors (IP Series)

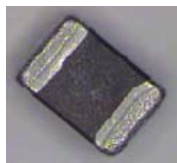

■ Feature

1. Small and light weight
2. Low DC resistance

■ Application

DC/DC converter for the Mobile equipment; Mobile Phone, DSC, WLAN

■ Ordering Code

IP **2012** **1R0** **M** **P** **S** **9**

PRODUCT CODE

IP : Multilayer Power Inductor (Lead Free)

DIMENSION (L X W)

Code	Dimension	EIA
1608	1.6 x 0.80 mm	0603
2012	2.0 X 1.25 mm	0805
2016	2.0 X 1.6 mm	0806
2520	2.5 X 2.0 mm	1008

INDUCTANCE CODE

Code	R47	1R0	1R5	2R2	3R3	4R7
Inductance (uH)	0.47	1.0	1.5	2.2	3.3	4.7

TOLERANCE CODE

M: ±20%

PACKAGING CODE

T: Paper tape reel
P: Embossed reel

SPECIFICATION CODE

S: Standard
L: Light loading current

THICKNESS CODE

Code	5	7	8	9	B
Thickness (mm)	0.5	0.7	0.8	0.9	1.2



■ **Standard External Dimensions**

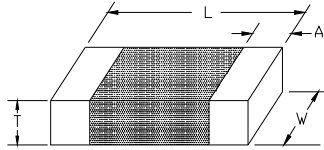

Unit: mm/(inch)

Series	L	W	T	A (Min/Max)	Packing Quantity (pcs/reel)	
					Paper Tape	Embossed Tape
IP2012 (0805)	2.0±0.2 (0.079±0.008)	1.25±0.2 (0.049±0.008)	0.55 max (0.021max)	0.20/0.80 (0.008/0.032)	4,000	----
IP2012 (0805)	2.0±0.2 (0.079±0.008)	1.25±0.2 (0.049±0.008)	1.0 max (0.039max)	0.20/0.80 (0.008/0.032)	----	3,000
IP2016 (0806)	2.0±0.2 (0.079±0.008)	1.6±0.2 (0.063±0.008)	1.0 max (0.039max)	0.20/0.80 (0.008/0.032)	----	3,000
IP2520 (1008)	2.5±0.2 (0.098±0.008)	2.0±0.2 (0.079±0.008)	1.0 max (0.039max)	0.20/0.80 (0.008/0.032)	----	3,000

Recommended Pad Dimensions

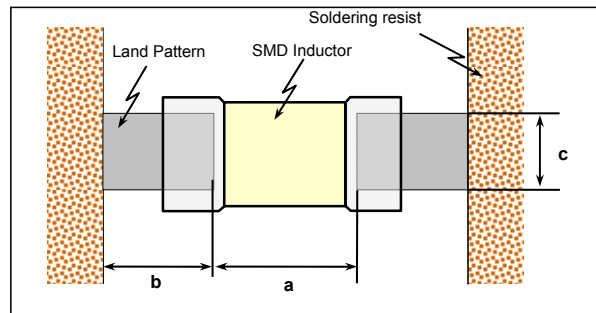

Size mm (EIA)	L x W (mm)	a (mm)	b (mm)	c (mm)
2012 (0805)	2.0 x 1.25	0.8 to 1.2	0.8 to 1.2	0.9 to 1.6
2016 (0806)	2.0 x 1.6	0.8 to 1.2	0.8 to 1.2	0.9 to 1.6
2520 (1008)	2.5 x 2.0	1.0 to 1.4	0.6 to 1.0	1.8 to 2.2

Unit: mm/(inch)

Part Numbers & Characteristic
● IP2012 (EIA 0805)

Ordering Code	Inductance [uH]	Inductance Tolerance	Measuring frequency [MHz]	DC Resistance [Ω]	Rated Current [A] (max.)	Saturation Current [A] (max.)	Thickness [mm] (max.)
IP2012R47MTS5	0.47	±20%	1	0.12±25%	1.10	0.90	0.55
IP20121R0MTS5	1.00			0.19±25%	0.90	0.70	
IP20122R2MTS5	2.20			0.34±25%	0.60	0.35	
IP2012R47MPS9	0.47	±20%	1	0.09±25%	1.20	1.20	1.0
IP20121R0MPS9	1.00			0.11±25%	1.00	1.10	
IP20121R5MPS9	1.50			0.13±25%	0.95	0.90	
IP20122R2MPS9	2.20			0.17±25%	0.95	0.55	
IP20123R3MPS9	3.30			0.19±25%	0.80	0.30	
IP20124R7MPS9	4.70			0.23±25%	0.80	0.18	
IP20124R7MPL9	4.70	±20%	1	0.25±25%	0.80	--	1.0
IP2012100MPL9	10.0		2	0.60±25%	0.50	--	

● IP2016 (EIA 0806)

Ordering Code	Inductance [uH]	Inductance Tolerance	Measuring frequency [MHz]	DC Resistance [Ω]	Rated Current [A] (max.)	Thickness [mm] (max.)
IP2016R47MPS9	0.47	±20%	1	0.07±25%	1.60	1.0
IP20161R0MPS9	1.00			0.11±25%	1.30	
IP20161R5MPS9	1.50			0.12±25%	1.20	
IP20162R2MPS9	2.20			0.13±25%	1.20	
IP20163R3MPS9	3.30			0.15±25%	1.10	
IP20164R7MPS9	4.70			0.18±25%	0.90	

● IP2520 (EIA 1008)

Ordering Code	Inductance [uH]	Inductance Tolerance	Measuring frequency [MHz]	DC Resistance [Ω]	Rated Current [A] (max.)	Saturation Current [A] (max.)	Thickness [mm] (max.)
IP25201R0MPS9	1.00	±20%	1	0.06±25%	1.60	0.90	1.0
IP25201R5MPS9	1.50			0.07±25%	1.50	0.70	
IP25202R2MPS9	2.20			0.09±25%	1.30	0.60	
IP25204R7MPS9	4.70			0.13±25%	1.10	0.25	

※Rated current specifies that self-heat generation is below 40°C during DC loaded (at 20°C)

※Saturated current specifies that inductance drop is below 30% during DC loaded (at 20°C)

※Operating temperature range from -55°C to 125°C.



Electric Properties
DC Bias characteristics

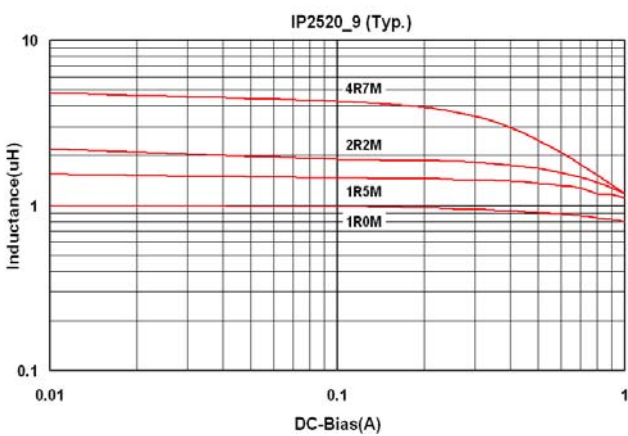
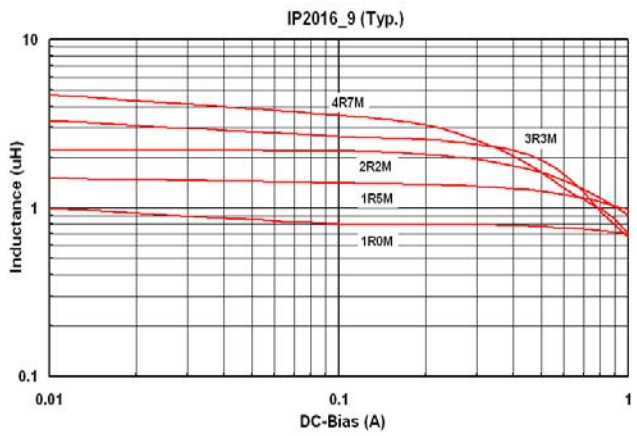
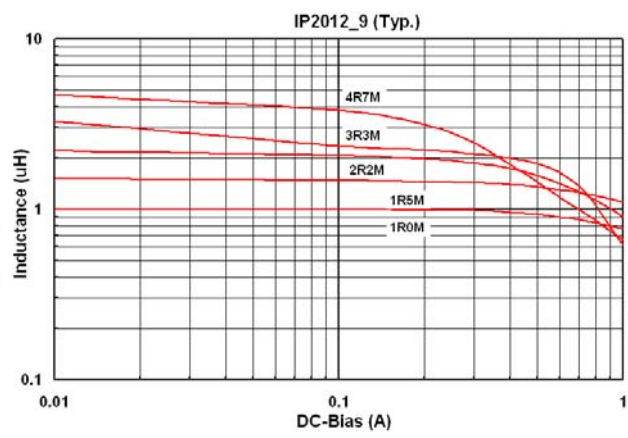
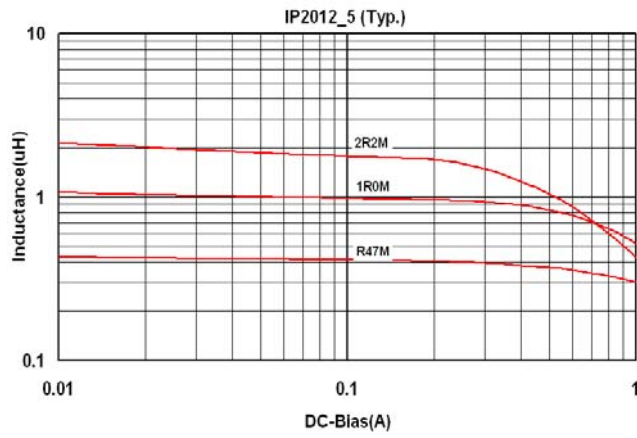

Inductance vs Frequency

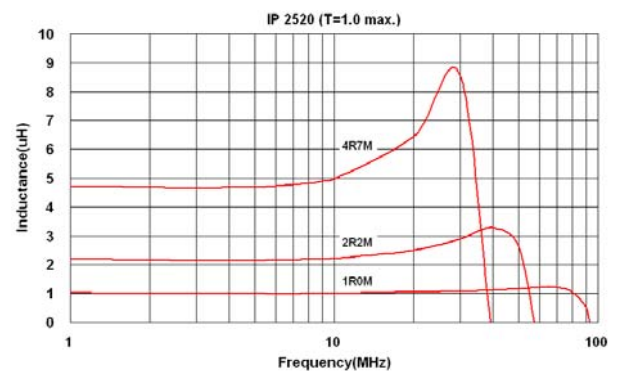
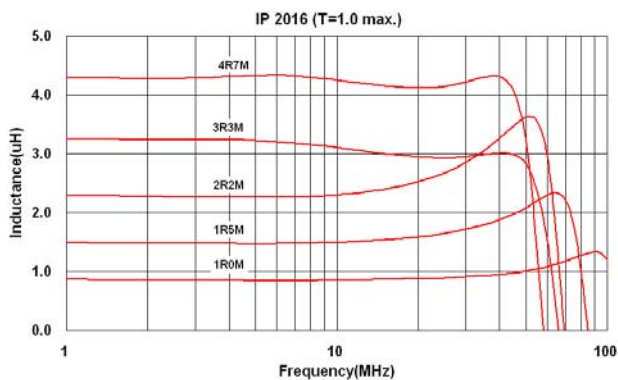
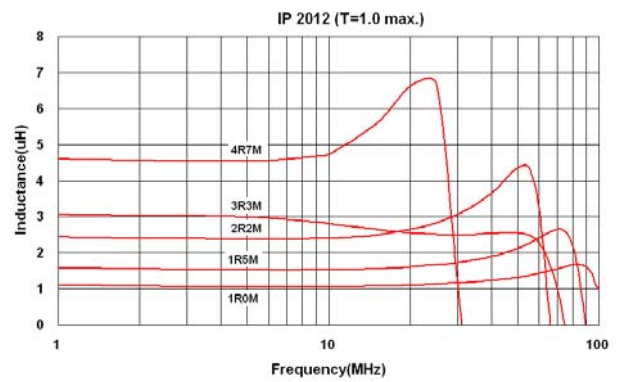
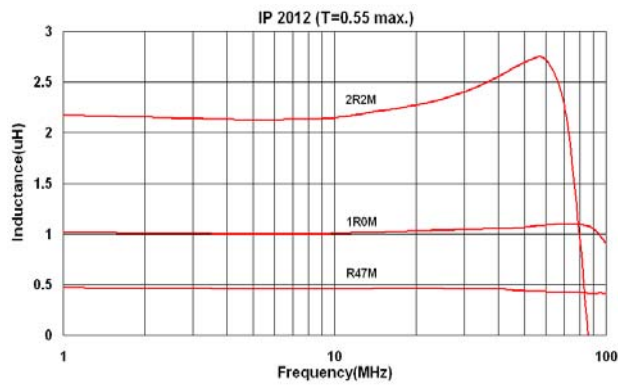

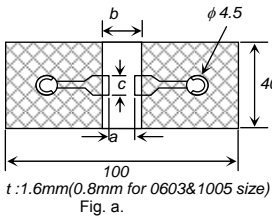
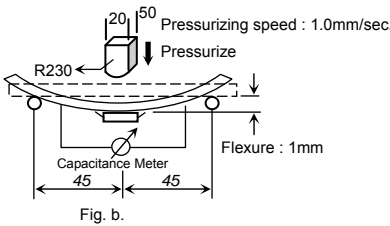

■ Testing Condition & Requirements

No.	Item	Test Condition	Requirements																				
1	Appearance	Inductors shall be visually inspected for visible evidence of defect.	No harmful defect for piratical use.																				
2	Inductance	a. Temperature: 25+/- 3°C b. Relative Humidity: 45 to 75%RH c. Measuring equipment: HP4286A 、HP4287A Measuring Jig: HP42851-61100	Within specified tolerance.																				
3	DC Resistance	Measuring instrument: HP4338B 、HIOKI IM-3570	In accordance with electrical specification.																				
4	Dimension	Dimension shall be measured with caliper or micrometer	In accordance with dimension specification.																				
5	Solder-ability	Immerse a test sample into a methanol solution containing rosin and immerse into SAC305(Sn96.5Ag3.0Cu0.5) solder of 245±5°C for 3±1 seconds.	90% of the termination is to be soldered evenly and continuously.																				
6	Resistance to Soldering Heat	Immerse a test sample into a methanol solution containing resin, preheat it at 150 to 180°C for 2~3 minutes and immerse into molten solder of 260+/-5°C for 10+/-1 second so that both terminal electrodes are completely submerged. After this test samples shall be taken out and measured after kept at room temperature for 2 to 3 hours.	No visible damage Remained terminal electrode : 70% min. Inductance variation within 30%																				
7	Bending Strength	Solder the chip to test jig then apply a force in the direction shown in below. The soldering shall be done with the reflow method and shall be conducted with care so that the soldering is uniform and free of defects such as heat shock.   <table border="1" data-bbox="478 1361 694 1478"> <thead> <tr> <th>Size</th> <th>a</th> <th>b</th> <th>C</th> </tr> </thead> <tbody> <tr> <td>1608</td> <td>1.0</td> <td>3.0</td> <td>1.2</td> </tr> <tr> <td>2012</td> <td>1.2</td> <td>4.0</td> <td>1.65</td> </tr> <tr> <td>2016</td> <td></td> <td></td> <td></td> </tr> <tr> <td>2520</td> <td></td> <td></td> <td></td> </tr> </tbody> </table>	Size	a	b	C	1608	1.0	3.0	1.2	2012	1.2	4.0	1.65	2016				2520				No mechanical damage shall be observed.
Size	a	b	C																				
1608	1.0	3.0	1.2																				
2012	1.2	4.0	1.65																				
2016																							
2520																							
8	Thermal Shock	Solder a test sample to printed circuit board, and conduct 5 cycles of test under the conditions shown as below. Condition for 1 cycle Step1: -55+0 / -2°C 30±3 min. Step2: Room temperature within 2 to 3 min. Step3: +125 +2 / -0°C 30±3 min. Measured at room temperature after placing for 2 to 3 hrs.	No visible damage Inductance variation within 30%																				



No.	Item	Test Condition	Requirements
9	High Humidity State Life Test	Keep a test sample in an atmosphere with a temperature of $40\pm 2^{\circ}\text{C}$, 90~95%RH for 500 +24/-0 hours. After the removal from test chamber, 2 to 3 hours of recovery under standard condition, and measurement shall be made after 24 ± 2 hrs of recovery under standard condition.	No visible damage. Inductance variation within 30%.
11	High Humidity Load Life Test	Solder a test sample to printed circuit board then keep the test sample in an atmosphere with a temperature of $40\pm 2^{\circ}\text{C}$, 90~95%RH for 500+24/-0 hours while supplying the rated current. After the removal from test chamber, 2 to 3 hours of recovery under standard condition, and measurement shall be made after 24 ± 2 hrs of recovery under standard condition.	No visible damage. Inductance variation within 30%.
12	High Temperature State Life Test	Keep a test sample in an atmosphere with a temperature of $85\pm 2^{\circ}\text{C}$ for 500+24/-0 hours. After the removal from test chamber, 2 to 3 hours of recovery under standard condition, and measurement shall be made after 24 ± 2 hrs of recovery under standard condition.	No visible damage. Inductance variation within 30%.
13	High Temperature Load	Solder a test sample to printed circuit board then keep the test sample in an atmosphere with a temperature of $85\pm 2^{\circ}\text{C}$ for 500+24/-0 hours while supplying the rated current. After the removal from test chamber, 2 to 3 hours of recovery under standard condition, and measurement shall be made after 24 ± 2 hrs of recovery under standard condition.	No visible damage. Inductance variation within 30%.



Multi-Layer High Frequency Inductors (HI Series)



■ Feature

1. For high frequency application
2. Tight tolerance physical dimensions
3. Tight Inductance tolerance, Excellent Q and Guaranteed SRF range

■ Application

For high frequency application: cellular phone, WLAN, PHS, EMI countermeasure in high frequency circuits and computer communication etc.

■ Ordering Code

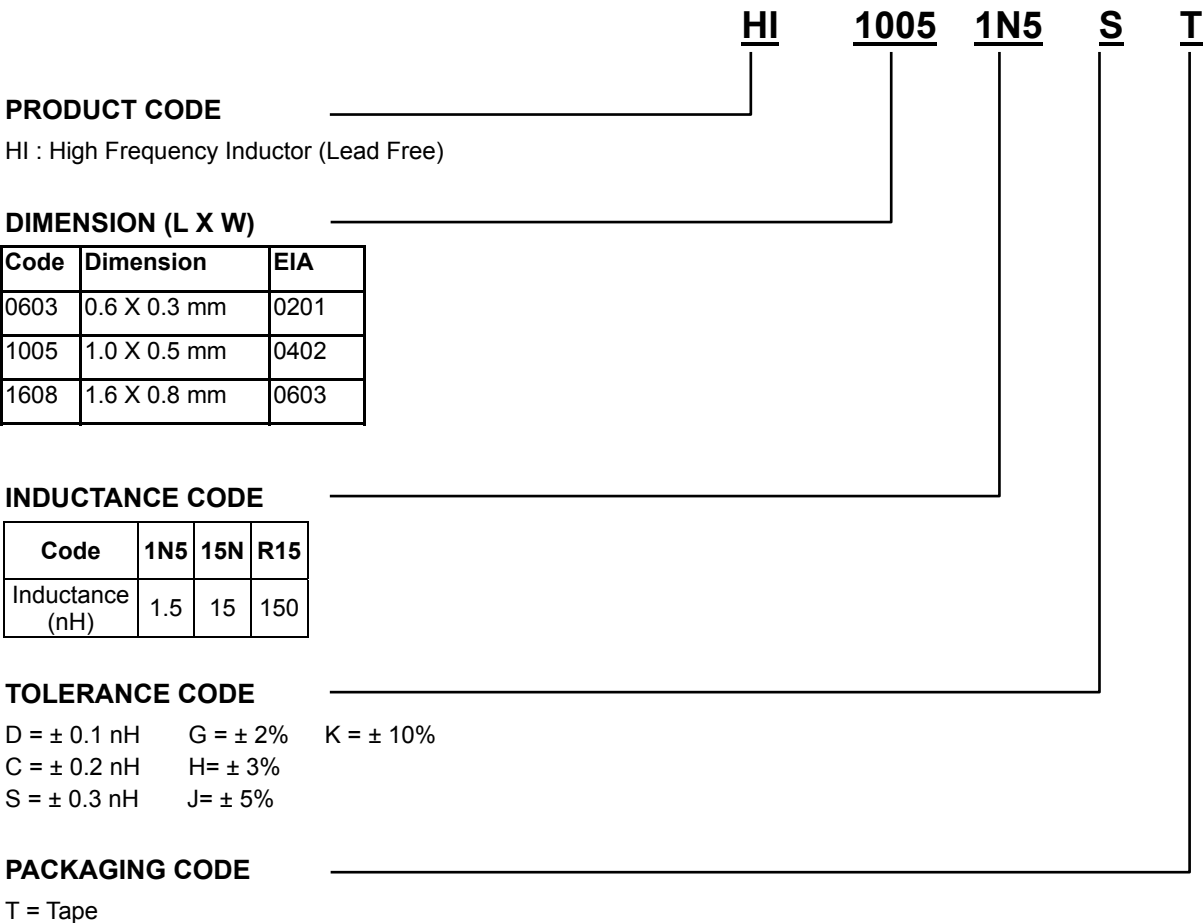



■ **Standard External Dimensions**

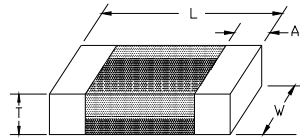

Unit: mm/(inch)

Series	L	W	T	A (Min/Max)	Packing Quantity (pcs/reel)
					Paper Tape
HI0603 (0201)	0.60±0.03 (0.024±0.001)	0.30±0.03 (0.012±0.001)	0.30±0.03 (0.012±0.001)	0.10/0.20 (0.004/0.008)	15,000
HI1005 (0402)	1.00±0.10 (0.040±0.004)	0.50±0.10 (0.020±0.004)	0.50±0.10 (0.020±0.004)	0.10/0.30 (0.004/0.012)	10,000
HI1608 (0603)	1.60±0.15 (0.063±0.006)	0.80±0.15 (0.031±0.006)	0.80±0.15 (0.031±0.006)	0.20/0.60 (0.008/0.024)	4,000

■ **Recommended Pad Dimensions**

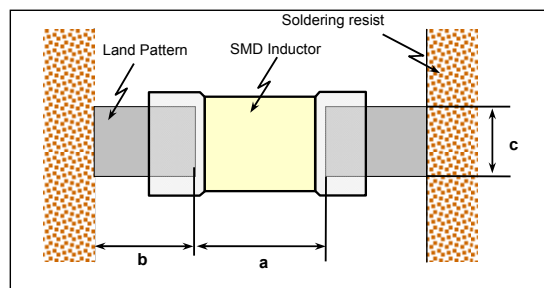

Size mm (EIA)	L x W (mm)	a (mm)	b (mm)	c (mm)
0603 (0201)	0.6*0.3	0.15 to 0.35	0.2 to 0.3	0.25 to 0.3
1005 (0402)	1.0*0.5	0.3 to 0.5	0.35 to 0.45	0.4 to 0.5
1608 (0603)	1.6*0.8	0.7 to 1.0	0.6 to 0.8	0.7 to 0.8

■ **Available Inductance Value**

Series	EIA Size	Available Inductance
HI0603	0201	0.3nH~100nH
HI1005	0402	0.6nH~270nH
HI1608	0603	1nH~470nH



Part Numbers & Characteristic

● **HI0603 series (EIA 0201)**

Ordering Code	Inductance (nH)	Available Tolerance	Q	L, Q Measuring Frequency	Self-Resonance Frequency (MHz)		DC Resistance (Ω)		Rated Current (mA)	Packing Amount of 7" reel
			Min.	(MHz)	Min.	typ.	Max.	typ.	Max.	Pcs
HI06030N3□T	0.3	±0.1nH	4	100	10,000	>13000	0.07	0.03	250	15,000
HI06030N4□T	0.4	±0.1nH	4	100	10,000	>13000	0.07	0.04	250	
HI06030N5□T	0.5	±0.1nH	4	100	10,000	>13000	0.08	0.05	250	
HI06030N6□T	0.6	±0.1nH	4	100	10,000	>13000	0.08	0.05	250	
HI06030N7□T	0.7	±0.1nH	4	100	10,000	>13000	0.09	0.06	250	
HI06030N8□T	0.8	±0.1nH	4	100	10,000	>13000	0.10	0.07	250	
HI06030N9□T	0.9	±0.1nH	4	100	10,000	>13,000	0.10	0.07	250	
HI06031N0□T	1.0	±0.3nH, ±0.1nH	4	100	10,000	>13,000	0.14	0.09	250	
HI06031N1□T	1.1	±0.3nH, ±0.2nH, ±0.1nH	4	100	10,000	>13,000	0.14	0.09	250	
HI06031N2□T	1.2	±0.3nH, ±0.2nH, ±0.1nH	4	100	10,000	>13,000	0.14	0.09	250	
HI06031N3□T	1.3	±0.3nH, ±0.2nH, ±0.1nH	4	100	10,000	>13,000	0.14	0.10	250	
HI06031N5□T	1.5	±0.3nH, ±0.2nH, ±0.1nH	4	100	10,000	>13,000	0.18	0.10	230	
HI06031N6□T	1.6	±0.3nH, ±0.2nH, ±0.1nH	4	100	10,000	>13,000	0.18	0.12	230	
HI06031N8□T	1.8	±0.3nH, ±0.2nH, ±0.1nH	4	100	10,000	>13,000	0.19	0.13	200	
HI06032N0□T	2.0	±0.3nH, ±0.2nH, ±0.1nH	4	100	8,800	>13,000	0.20	0.14	200	
HI06032N1□T	2.1	±0.3nH, ±0.2nH, ±0.1nH	4	100	8,800	>13,000	0.20	0.15	200	
HI06032N2□T	2.2	±0.3nH, ±0.2nH, ±0.1nH	4	100	8,800	>13,000	0.22	0.15	200	
HI06032N4□T	2.4	±0.3nH, ±0.2nH, ±0.1nH	4	100	8,300	11,700	0.24	0.15	200	
HI06032N7□T	2.7	±0.3nH, ±0.2nH, ±0.1nH	5	100	7,700	11,340	0.25	0.17	200	
HI06033N0□T	3.0	±0.3nH, ±0.2nH, ±0.1nH	5	100	7,200	11,000	0.28	0.20	180	
HI06033N2□T	3.2	±0.3nH, ±0.2nH, ±0.1nH	5	100	6,700	10,800	0.30	0.20	180	
HI06033N3□T	3.3	±0.3nH, ±0.2nH, ±0.1nH	5	100	6,700	10,400	0.30	0.20	180	
HI06033N6□T	3.6	±0.3nH, ±0.2nH, ±0.1nH	5	100	6,400	9,000	0.30	0.23	170	
HI06033N9□T	3.9	±0.3nH, ±0.2nH, ±0.1nH	5	100	6,000	8,790	0.30	0.23	170	
HI06034N3□T	4.3	±0.3nH, ±3%, ±0.1nH	5	100	5,700	8,000	0.40	0.24	150	
HI06034N7□T	4.7	±0.3nH, ±3%, ±0.1nH	5	100	5,300	7,750	0.40	0.26	150	
HI06035N1□T	5.1	±0.3nH, ±3%, ±0.1nH	5	100	5,000	7,210	0.40	0.26	150	
HI06035N6□T	5.6	±0.3nH, ±3%, ±0.1nH	5	100	4,200	6,680	0.40	0.32	150	
HI06036N2□T	6.2	±0.3nH, ±3%, ±0.1nH	5	100	3,800	6,800	0.44	0.32	150	
HI06036N8□T	6.8	±5%, ±3%	5	100	3,500	6,800	0.50	0.34	150	
HI06037N5□T	7.5	±5%, ±3%	5	100	3,300	6,000	0.53	0.36	150	
HI06038N2□T	8.2	±5%, ±3%	5	100	3,200	5,800	0.55	0.38	150	
HI06039N1□T	9.1	±5%, ±3%	5	100	3,000	5,000	0.62	0.38	150	
HI060310N□T	10	±5%, ±3%	5	100	2,800	4,860	0.65	0.40	150	
HI060312N□T	12	±5%, ±3%	5	100	2,400	4,520	0.70	0.50	100	
HI060315N□T	15	±5%, ±3%	5	100	2,200	4,820	0.80	0.60	100	
HI060318N□T	18	±5%, ±3%	5	100	2,200	3,000	0.90	0.85	100	
HI060322N□T	22	±5%, ±3%	5	100	1,800	2,950	1.20	0.86	100	
HI060327N□T	27	±5%, ±3%	4	100	1,800	2,610	1.80	0.88	50	
HI060333N□T	33	±5%	4	100	1,700	2,210	2.10	1.05	50	
HI060339N□T	39	±5%	4	100	1,500	1,860	2.40	1.18	50	
HI060347N□T	47	±5%	4	100	1,300	1,800	2.80	1.74	100	
HI060356N□T	56	±5%	4	100	1,100	1,600	3.00	1.85	80	
HI060368N□T	68	±5%	4	100	1,100	1,500	2.66	2.30	80	
HI060382N□T	82	±5%	4	100	1,000	1,400	3.37	2.60	70	
HI0603R10□T	100	±5%	4	100	900	1,200	3.74	3.00	60	

□ Tolerance: D=±0.1nH, C=±0.2nH, S=±0.3nH, G=±2%, H=±3%, J=±5%, K=±10%

※ Operating Temperature range: -55 °C to +125 °C



L,Q vs. Frequency Characteristics

Ordering Code	Typical Inductance(nH)							Typical Q						
	100 MHz	500 MHz	800 MHz	900 MHz	1.8 GHz	2.0 GHz	2.4 GHz	100 MHz	500 MHz	800 MHz	900 MHz	1.8 GHz	2.0 GHz	2.4 GHz
HI06030N3□□T	0.3	0.3	0.3	0.3	0.3	0.3	0.3	6	14	19	20	32	35	39
HI06030N4□□T	0.4	0.4	0.4	0.4	0.4	0.4	0.4	6	14	19	20	32	35	39
HI06030N5□□T	0.5	0.5	0.5	0.5	0.5	0.5	0.5	6	14	19	20	33	36	40
HI06030N6□□T	0.6	0.6	0.5	0.5	0.5	0.5	0.5	6	15	19	20	33	36	40
HI06030N7□□T	0.7	0.7	0.6	0.6	0.6	0.6	0.6	6	15	20	21	34	37	41
HI06030N8□□T	0.8	0.8	0.7	0.7	0.7	0.7	0.7	6	14	19	20	32	35	39
HI06030N9□□T	0.9	0.8	0.8	0.8	0.8	0.8	0.8	6	15	20	21	35	37	42
HI06031N0□□T	1.0	0.9	0.9	0.9	0.9	0.9	0.9	5	13	17	18	28	30	33
HI06031N1□□T	1.1	1.0	1.0	1.0	0.9	0.9	0.9	6	14	18	20	30	32	34
HI06031N2□□T	1.2	1.2	1.2	1.2	1.2	1.2	1.2	6	14	18	19	28	30	32
HI06031N3□□T	1.3	1.2	1.2	1.2	1.2	1.2	1.2	6	13	17	18	27	28	31
HI06031N5□□T	1.5	1.4	1.3	1.3	1.4	1.4	1.4	6	14	18	20	30	32	34
HI06031N6□□T	1.6	1.6	1.6	1.6	1.6	1.6	1.6	6	14	18	20	28	30	31
HI06031N8□□T	1.8	1.7	1.7	1.7	1.7	1.7	1.7	6	14	18	20	28	30	31
HI06032N0□□T	2.0	1.9	1.9	1.9	2.0	1.9	2.0	6	14	18	19	28	29	31
HI06032N1□□T	2.1	2.0	1.9	1.9	2.0	2.0	2.1	6	13	17	18	26	28	30
HI06032N2□□T	2.2	2.1	2.0	2.0	2.1	2.1	2.2	6	13	17	18	26	28	30
HI06032N4□□T	2.4	2.3	2.2	2.2	2.3	2.4	2.5	6	14	18	20	28	29	31
HI06032N7□□T	2.7	2.5	2.5	2.5	2.6	2.7	2.8	6	14	18	19	28	29	31
HI06033N0□□T	3.0	2.8	2.8	2.8	2.9	2.9	3.0	7	15	19	21	30	31	33
HI06033N2□□T	3.2	3.0	3.0	3.0	3.1	3.1	3.2	6	14	19	20	29	30	32
HI06033N3□□T	3.3	3.2	3.1	3.2	3.0	3.4	3.5	6	14	19	20	29	30	32
HI06033N6□□T	3.6	3.4	3.4	3.4	3.7	3.7	3.9	6	14	18	20	28	29	31
HI06033N9□□T	3.9	3.7	3.7	3.7	3.9	4.0	4.2	6	15	19	20	28	29	31
HI06034N3□□T	4.3	4.1	4.1	4.1	4.4	4.9	4.8	6	14	18	19	27	28	29
HI06034N7□□T	4.7	4.4	4.4	4.4	4.8	4.9	5.2	6	14	19	19	26	27	29
HI06035N1□□T	5.1	4.9	4.9	4.9	5.4	5.6	6.0	6	13	17	18	25	25	26
HI06035N6□□T	5.6	5.3	5.3	5.3	5.8	6.0	6.6	7	14	18	19	26	27	27
HI06036N2□□T	6.2	6.0	6.0	6.1	6.9	7.2	8.1	6	14	18	19	26	26	30
HI06036N8□□T	6.8	6.3	6.4	6.4	7.2	7.4	8.2	7	14	18	19	26	26	26
HI06037N5□□T	7.5	7.1	7.2	7.2	8.3	8.7	9.8	6	15	18	20	25	25	25
HI06038N2□□T	8.2	7.8	7.9	8.0	9.2	9.7	11.0	7	15	18	19	19	24	24
HI06039N1□□T	9.1	8.7	8.8	8.9	10.8	11.6	13.9	6	13	16	17	21	20	18
HI060310N□□T	10.0	9.3	9.5	9.6	12.0	13.0	16.1	6	13	16	17	20	20	18
HI060312N□□T	12.0	11.3	11.5	11.7	15.4	17.2	23.2	7	13	16	17	18	17	14
HI060315N□□T	15.0	14.5	15.1	15.4	22.4	26.2	42.3	7	15	18	19	19	17	11
HI060318N□□T	18.0	17.2	18.1	18.6	31.1	39.5	99.3	7	13	16	16	14	11	5
HI060322N□□T	22.0	21.4	22.8	23.5	45.5	64.1	-	7	13	16	16	12	8	-
HI060327N□□T	27.0	26.6	29.2	30.6	108.5	-	-	6	13	15	15	6	-	-
HI060333N□□T	33.0	31.9	34.8	36.0	119.0	-	-	7	14	16	17	6	-	-
HI060339N□□T	39.0	38.2	42.3	45.6	-	-	-	6	12	13	13	-	-	-
HI060347N□□T	47.0	44.0	47.0	49.0	-	-	-	6	11	12	11	-	-	-
HI060356N□□T	56.0	54.0	61.0	66.0	-	-	-	6	11	11	10	-	-	-
HI060368N□□T	68.0	66.0	76.0	82.0	-	-	-	6	11	11	10	-	-	-
HI060382N□□T	82.0	80.0	97.0	108.0	-	-	-	6	11	10	8	-	-	-
HI0603R10□□T	100.0	103.0	138.0	164.0	-	-	-	6	10	9	6	-	-	-

Typical Electrical Characteristic

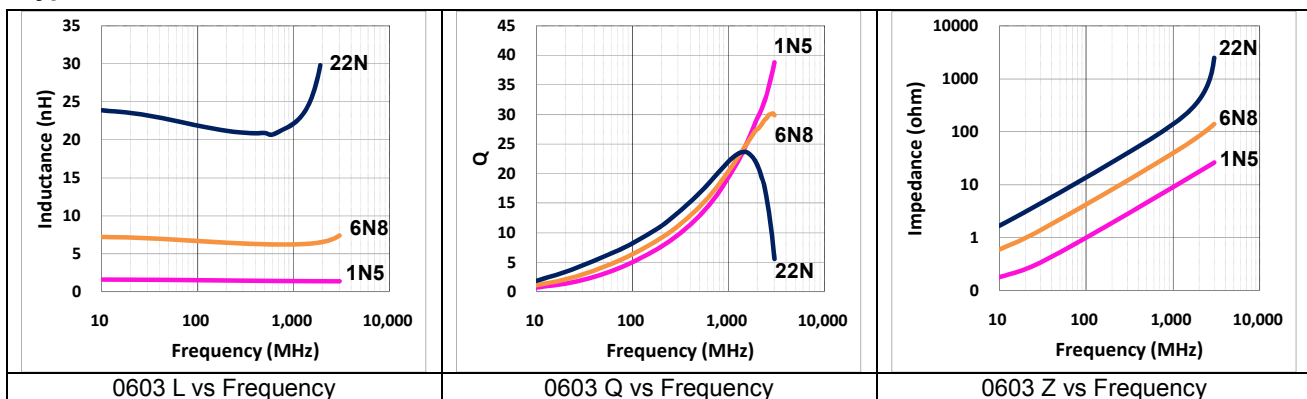



● HI1005 series (EIA 0402)

Ordering Code	Inductance (nH)	Available Tolerance	Q	L, Q Measuring Frequency	Self-Resonance Frequency (MHz)		DC Resistance (Ω)		Rated Current (mA)	Packing Amount of 7" reel
			Min.	(MHz)	Min.	typ.	Max.	typ.	Max.	Pcs
HI10050N6□T	0.6	$\pm 0.1\text{nH}$	8	100	10,000	>13,000	0.08	0.02	1000	10,000
HI10051N0□T	1.0	$\pm 0.3\text{nH}, \pm 0.2\text{nH}, \pm 0.1\text{nH}$	8	100	10,000	>13,000	0.08	0.02	1000	
HI10051N1□T	1.1	$\pm 0.3\text{nH}, \pm 0.2\text{nH}, \pm 0.1\text{nH}$	8	100	10,000	>13,000	0.08	0.03	1000	
HI10051N2□T	1.2	$\pm 0.3\text{nH}, \pm 0.2\text{nH}, \pm 0.1\text{nH}$	8	100	10,000	>13,000	0.09	0.03	1000	
HI10051N3□T	1.3	$\pm 0.3\text{nH}, \pm 0.2\text{nH}, \pm 0.1\text{nH}$	8	100	10,000	>13,000	0.09	0.04	1000	
HI10051N5□T	1.5	$\pm 0.3\text{nH}, \pm 0.2\text{nH}, \pm 0.1\text{nH}$	8	100	10,000	>13,000	0.10	0.05	1000	
HI10051N6□T	1.6	$\pm 0.3\text{nH}, \pm 0.2\text{nH}, \pm 0.1\text{nH}$	8	100	10,000	>13,000	0.10	0.05	1000	
HI10051N8□T	1.8	$\pm 0.3\text{nH}, \pm 0.2\text{nH}, \pm 0.1\text{nH}$	8	100	6,000	12,220	0.12	0.05	900	
HI10052N0□T	2.0	$\pm 0.3\text{nH}, \pm 0.2\text{nH}, \pm 0.1\text{nH}$	8	100	6,000	12,890	0.12	0.06	900	
HI10052N2□T	2.2	$\pm 0.3\text{nH}, \pm 0.2\text{nH}, \pm 0.1\text{nH}$	8	100	6,000	12,430	0.13	0.06	900	
HI10052N4□T	2.4	$\pm 0.3\text{nH}, \pm 0.2\text{nH}, \pm 0.1\text{nH}$	8	100	6,000	12,320	0.13	0.07	800	
HI10052N7□T	2.7	$\pm 0.3\text{nH}, \pm 0.2\text{nH}, \pm 0.1\text{nH}$	8	100	6,000	10,070	0.16	0.09	800	
HI10053N0□T	3.0	$\pm 0.3\text{nH}, \pm 0.2\text{nH}, \pm 0.1\text{nH}$	8	100	6,000	8,760	0.16	0.09	800	
HI10053N3□T	3.3	$\pm 0.3\text{nH}, \pm 0.2\text{nH}, \pm 0.1\text{nH}$	8	100	6,000	8,120	0.16	0.09	800	
HI10053N6□T	3.6	$\pm 0.3\text{nH}, \pm 0.2\text{nH}, \pm 0.1\text{nH}$	8	100	5,000	8,200	0.20	0.10	700	
HI10053N9□T	3.9	$\pm 0.3\text{nH}, \pm 0.2\text{nH}, \pm 0.1\text{nH}$	8	100	4,000	8,390	0.20	0.10	700	
HI10054N3□T	4.3	$\pm 0.3\text{nH}, \pm 0.2\text{nH}, \pm 0.1\text{nH}$	8	100	4,000	7,500	0.20	0.11	700	
HI10054N7□T	4.7	$\pm 0.3\text{nH}, \pm 0.2\text{nH}, \pm 0.1\text{nH}$	8	100	4,000	7,010	0.20	0.11	700	
HI10055N1□T	5.1	$\pm 0.3\text{nH}, \pm 0.2\text{nH}, \pm 0.1\text{nH}$	8	100	4,000	6,340	0.23	0.13	600	
HI10055N6□T	5.6	$\pm 0.3\text{nH}, \pm 0.2\text{nH}, \pm 0.1\text{nH}$	8	100	4,000	5,760	0.23	0.13	600	
HI10056N2□T	6.2	$\pm 0.3\text{nH}, \pm 0.2\text{nH}, \pm 0.1\text{nH}$	8	100	3,900	5,490	0.25	0.15	600	
HI10056N8□T	6.8	$\pm 5\%, \pm 3\%, \pm 2\%$	8	100	3,900	5,430	0.25	0.14	600	
HI10057N5□T	7.5	$\pm 5\%, \pm 3\%, \pm 2\%$	8	100	3,700	5,000	0.28	0.16	500	
HI10058N2□T	8.2	$\pm 5\%, \pm 3\%, \pm 2\%$	8	100	3,500	4,660	0.28	0.17	500	
HI10059N1□T	9.1	$\pm 5\%, \pm 3\%, \pm 2\%$	8	100	3,400	4,400	0.30	0.22	500	
HI100510N□T	10	$\pm 5\%, \pm 3\%, \pm 2\%$	8	100	3,200	4,120	0.31	0.24	500	
HI100512N□T	12	$\pm 5\%, \pm 3\%, \pm 2\%$	8	100	2,600	3,820	0.45	0.30	400	
HI100515N□T	15	$\pm 5\%, \pm 3\%, \pm 2\%$	8	100	2,300	3,350	0.55	0.38	400	
HI100518N□T	18	$\pm 5\%, \pm 3\%, \pm 2\%$	8	100	2,000	2,970	0.65	0.37	300	
HI100522N□T	22	$\pm 5\%, \pm 3\%, \pm 2\%$	8	100	1,600	2,640	0.70	0.45	300	
HI100524N□T	24	$\pm 5\%, \pm 3\%, \pm 2\%$	8	100	1,400	2,450	0.80	0.48	300	
HI100527N□T	27	$\pm 5\%, \pm 3\%, \pm 2\%$	8	100	1,400	2,370	0.80	0.49	300	
HI100533N□T	33	$\pm 5\%, \pm 3\%, \pm 2\%$	8	100	1,200	2,040	0.90	0.63	200	
HI100539N□T	39	$\pm 5\%, \pm 3\%, \pm 2\%$	8	100	1,100	1,800	1.00	0.70	200	
HI100547N□T	47	$\pm 5\%, \pm 3\%, \pm 2\%$	8	100	900	1,660	1.10	0.82	200	



Ordering Code	Inductance (nH)	Available Tolerance	Q	L, Q Measuring Frequency	Self-Resonance Frequency (MHz)		DC Resistance (Ω)		Rated Current (mA)	Packing Amount of 7" reel
			Min.	(MHz)	Min.	typ.	Max.	typ.	Max.	Pcs
HI100556N□T	56	$\pm 5\%, \pm 3\%, \pm 2\%$	8	100	750	1,560	1.10	0.84	200	10,000
HI100568N□T	68	$\pm 5\%, \pm 3\%, \pm 2\%$	8	100	750	1,330	1.20	0.99	180	
HI100582N□T	82	$\pm 5\%, \pm 3\%$	8	100	600	1,160	1.30	1.09	150	
HI1005R10□T	100	$\pm 5\%$	8	100	600	1,020	1.60	1.19	150	
HI1005R12□T	120	$\pm 5\%$	8	100	600	860	1.60	1.31	150	
HI1005R15□T	150	$\pm 5\%$	8	100	550	800	2.40	1.58	140	
HI1005R18□T	180	$\pm 5\%$	8	100	500	810	3.70	2.97	130	
HI1005R22□T	220	$\pm 5\%$	8	100	450	700	4.20	3.29	120	
HI1005R27□T	270	$\pm 5\%$	8	100	400	600	4.80	3.92	110	

※ □ Tolerance: D= ± 0.1 nH, C= ± 0.2 nH, S= ± 0.3 nH, G= $\pm 2\%$, H= $\pm 3\%$, J= $\pm 5\%$, K= $\pm 10\%$

※ Operating Temperature range: $-55\text{ }^{\circ}\text{C}$ to $+125\text{ }^{\circ}\text{C}$



L,Q vs. Frequency Characteristics

Ordering Code	Typical Inductance(nH)							Typical Q						
	100 MHz	500 MHz	800 MHz	900 MHz	1.8 GHz	2.0 GHz	2.4 GHz	100 MHz	500 MHz	800 MHz	900 MHz	1.8 GHz	2.0 GHz	2.4 GHz
HI10050N6	0.6	0.6	0.6	0.6	0.6	0.6	0.6	12	40	60	65	100	120	140
HI10051N0	1.0	1.0	1.0	1.0	1.0	1.0	1.0	12	29	38	41	63	71	75
HI10051N1	1.1	1.1	1.1	1.1	1.1	1.1	1.1	11	29	37	40	60	67	72
HI10051N2	1.2	1.2	1.2	1.2	1.2	1.2	1.2	11	29	38	41	61	68	73
HI10051N3	1.3	1.3	1.3	1.3	1.3	1.3	1.3	11	30	38	41	61	67	72
HI10051N5	1.5	1.5	1.5	1.5	1.5	1.5	1.5	11	27	35	38	57	63	68
HI10051N6	1.6	1.5	1.5	1.5	1.5	1.5	1.5	11	28	35	38	57	64	68
HI10051N8	1.8	1.7	1.7	1.7	1.7	1.7	1.8	11	26	33	36	53	58	61
HI10052N0	2.0	2.0	2.0	2.0	2.0	2.1	2.1	10	23	29	31	45	49	52
HI10052N2	2.2	2.1	2.1	2.1	2.2	2.2	2.2	10	24	31	33	48	52	55
HI10052N4	2.4	2.3	2.3	2.3	2.4	2.4	2.4	10	25	31	34	49	53	57
HI10052N7	2.7	2.7	2.7	2.7	2.8	2.8	2.9	11	27	35	37	54	58	60
HI10053N0	3.0	2.9	2.9	3.0	3.1	3.1	3.2	10	25	32	34	49	53	55
HI10053N3	3.3	3.2	3.2	3.2	3.4	3.4	3.5	11	25	32	35	50	54	56
HI10053N6	3.6	3.5	3.5	3.5	3.7	3.8	3.9	10	24	31	33	46	49	49
HI10053N9	3.9	3.7	3.7	3.8	3.9	4.0	4.1	11	24	30	33	46	49	51
HI10054N3	4.3	4.1	4.2	4.2	4.4	4.4	4.6	11	26	33	35	50	53	54
HI10054N7	4.7	4.5	4.5	4.5	4.8	4.9	5.1	11	25	32	35	49	51	53
HI10055N1	5.1	4.9	4.9	4.9	5.2	5.3	5.6	11	25	32	35	46	48	49
HI10055N6	5.6	5.5	5.5	5.5	6.0	6.2	6.7	11	25	32	35	46	48	49
HI10056N2	6.2	6.1	6.1	6.1	6.7	6.8	7.3	11	26	32	34	46	48	49
HI10056N8	6.8	6.6	6.7	6.7	7.4	7.6	8.2	11	26	32	35	46	48	48
HI10057N5	7.5	7.1	7.2	7.3	7.8	8.1	8.8	11	26	32	35	46	48	48
HI10058N2	8.2	8.0	8.1	8.2	9.4	9.9	11.1	11	26	32	34	42	42	40
HI10059N1	9.1	8.7	8.8	8.8	9.9	10.2	11.1	11	25	31	34	42	42	40
HI100510N	10.0	10.0	9.8	9.9	11.7	12.4	14.4	11	23	29	31	37	37	34
HI100512N	12.0	11.7	12.0	12.2	15.1	16.3	20.1	11	24	31	33	37	36	30
HI100515N	15.0	14.9	15.5	15.8	22.8	26.4	41.8	11	23	30	32	35	33	28
HI100518N	18.0	17.8	18.4	18.7	24.9	27.7	37.7	11	23	28	29	30	28	22
HI100522N	22.0	21.8	23.1	23.8	40.9	52.7	156.0	11	22	27	28	22	18	6
HI100527N	27.0	27.1	29.2	30.3	66.8	106.9	-	11	22	26	27	16	11	4
HI100533N	33.0	33.2	36.3	37.9	109.0	259.0	-	11	22	25	26	12	5	-
HI100539N	39.0	40.2	45.9	49.1	-	-	-	11	20	22	22	-	-	-
HI100547N	47.0	49.1	57.2	61.7	-	-	-	11	20	21	21	-	-	-
HI100556N	56.0	59.2	71.8	79.3	-	-	-	11	19	19	18	-	-	-
HI100568N	68.0	74.7	99.4	116.3	-	-	-	11	18	17	15	-	-	-
HI100582N	82.0	94.7	140.8	179.5	-	-	-	11	18	15	12	-	-	-
HI1005R10	100.0	117.6	193.7	269.9	-	-	-	11	17	12	9	-	-	-
HI1005R12	120.0	159.8	450.4	-	-	-	-	11	16	7	-	-	-	-
HI1005R15	150.0	207.2	-	-	-	-	-	11	14	-	-	-	-	-
HI1005R18	180.0	-	-	-	-	-	-	12	-	-	-	-	-	-
HI1005R22	220.0	-	-	-	-	-	-	12	-	-	-	-	-	-
HI1005R27	270.0	-	-	-	-	-	-	12	-	-	-	-	-	-

Typical Electrical Characteristic

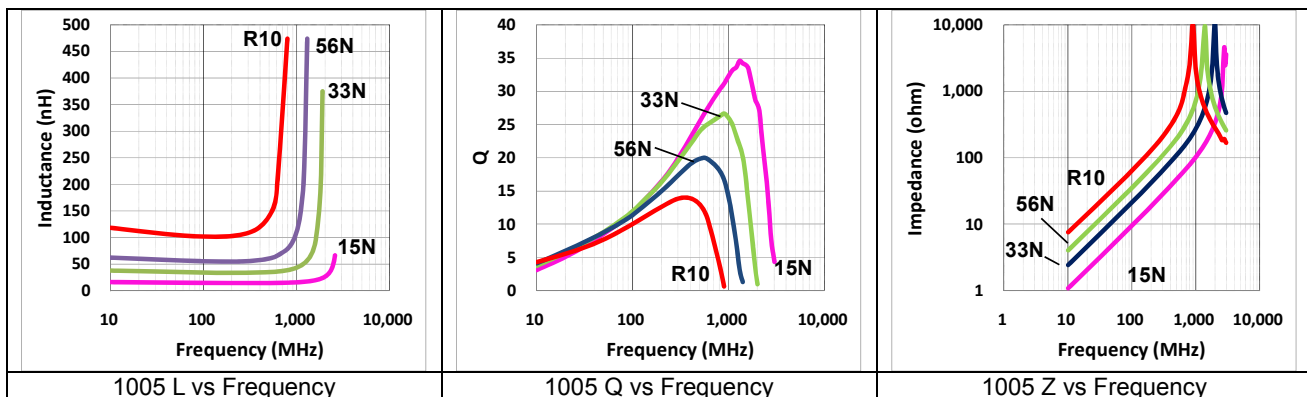



● HI1608 series (EIA 0603)

Ordering Code	Inductance (nH)	Available Tolerance	Q	L, Q Measuring Frequency	Self-Resonance Frequency (MHz)		DC Resistance (Ω)		Rated Current (mA)	Packing Amount of 7" reel
			Min.	(MHz)	Min.	typ.	Max.	typ.	Max.	Pcs
HI16081N0□T	1.0	$\pm 0.3\text{nH}$, $\pm 0.1\text{nH}$	8	100	10,000	>13,000	0.05	0.01	1,000	4,000
HI16081N2□T	1.2	$\pm 0.3\text{nH}$, $\pm 0.1\text{nH}$	8	100	10,000	>13,000	0.05	0.02	1,000	
HI16081N5□T	1.5	$\pm 0.3\text{nH}$, $\pm 0.1\text{nH}$	8	100	10,000	>13,000	0.10	0.03	1,000	
HI16081N8□T	1.8	$\pm 0.3\text{nH}$, $\pm 0.1\text{nH}$	8	100	10,000	>13,000	0.10	0.04	1,000	
HI16082N2□T	2.2	$\pm 0.3\text{nH}$, $\pm 0.1\text{nH}$	8	100	6,000	11,690	0.10	0.05	1,000	
HI16082N7□T	2.7	$\pm 0.3\text{nH}$, $\pm 0.1\text{nH}$	10	100	6,000	8,930	0.13	0.06	1,000	
HI16083N3□T	3.3	$\pm 0.3\text{nH}$, $\pm 0.1\text{nH}$	10	100	6,000	6,440	0.13	0.07	1,000	
HI16083N9□T	3.9	$\pm 0.3\text{nH}$, $\pm 0.1\text{nH}$	10	100	6,000	7,280	0.15	0.08	1,000	
HI16084N7□T	4.7	$\pm 0.3\text{nH}$, $\pm 0.1\text{nH}$	10	100	4,000	6,470	0.20	0.09	1,000	
HI16085N6□T	5.6	$\pm 0.3\text{nH}$, $\pm 0.1\text{nH}$	10	100	4,000	5,230	0.23	0.10	600	
HI16086N8□T	6.8	$\pm 5\%$, $\pm 2\%$	10	100	4,000	5,470	0.25	0.11	600	
HI16088N2□T	8.2	$\pm 5\%$, $\pm 2\%$	10	100	3,500	4,460	0.28	0.14	600	
HI160810N□T	10	$\pm 5\%$, $\pm 2\%$	12	100	3,200	4,360	0.30	0.15	600	
HI160812N□T	12	$\pm 5\%$, $\pm 2\%$	12	100	2,600	3,480	0.35	0.17	600	
HI160815N□T	15	$\pm 5\%$, $\pm 2\%$	12	100	2,300	3,310	0.40	0.19	600	
HI160818N□T	18	$\pm 5\%$, $\pm 2\%$	12	100	2,000	3,080	0.45	0.21	600	
HI160822N□T	22	$\pm 5\%$, $\pm 2\%$	12	100	1,600	2,670	0.50	0.29	600	
HI160827N□T	27	$\pm 5\%$, $\pm 2\%$	12	100	1,400	2,270	0.55	0.27	600	
HI160833N□T	33	$\pm 5\%$, $\pm 2\%$	12	100	1,200	1,970	0.60	0.36	600	
HI160839N□T	39	$\pm 5\%$, $\pm 2\%$	12	100	1,100	1,830	0.65	0.37	500	
HI160847N□T	47	$\pm 5\%$, $\pm 2\%$	12	100	900	1,670	0.70	0.47	500	
HI160856N□T	56	$\pm 5\%$, $\pm 2\%$	12	100	900	1,530	0.75	0.46	500	
HI160868N□T	68	$\pm 5\%$, $\pm 2\%$	12	100	700	1,360	0.85	0.51	400	
HI160882N□T	82	$\pm 5\%$, $\pm 2\%$	12	100	600	1,290	0.95	0.57	300	
HI1608R10□T	100	$\pm 5\%$, $\pm 2\%$	12	100	600	1,090	1.00	0.69	300	
HI1608R12□T	120	$\pm 5\%$, $\pm 2\%$	8	50	500	1,030	1.20	0.74	300	
HI1608R15□T	150	$\pm 5\%$, $\pm 2\%$	8	50	500	820	1.20	0.78	300	
HI1608R18□T	180	$\pm 5\%$, $\pm 2\%$	8	50	400	690	1.30	0.92	300	
HI1608R22□T	220	$\pm 5\%$, $\pm 2\%$	8	50	400	630	1.50	1.19	300	
HI1608R27□T	270	$\pm 5\%$, $\pm 2\%$	8	50	400	520	1.90	1.19	150	
HI1608R33□T	330	$\pm 5\%$, $\pm 2\%$	8	50	350	450	2.10	1.50	150	
HI1608R39□T	390	$\pm 5\%$, $\pm 2\%$	8	50	350	400	2.30	1.80	150	
HI1608R47□T	470	$\pm 5\%$, $\pm 2\%$	8	50	300	360	2.60	2.04	150	

※ □ Tolerance: D= $\pm 0.1\text{nH}$, C= $\pm 0.2\text{nH}$, S= $\pm 0.3\text{nH}$, G= $\pm 2\%$, J= $\pm 5\%$, K= $\pm 10\%$

※ Operating Temperature range: $-40\text{ }^{\circ}\text{C}$ to $+85\text{ }^{\circ}\text{C}$



L,Q vs. Frequency Characteristics

Ordering Code	Typical Inductance(nH)							Typical Q						
	100MH	500MH	800MH	900MH	1.8GHz	2.0GHz	2.4GHz	100MH	500MH	800MH	900MH	1.8GHz	2.0GHz	2.4GHz
HI16081N0□T	1.0	1.1	1.1	1.1	1.1	1.1	1.0	14	40	53	60	93	32	174
HI16081N2□T	1.2	1.2	1.2	1.2	1.2	1.2	1.1	14	38	49	54	84	32	143
HI16081N5□T	1.5	1.6	1.6	1.6	1.6	1.5	1.5	12	31	39	43	62	33	88
HI16081N8□T	1.8	1.8	1.8	1.8	1.8	1.8	1.7	13	34	42	46	68	37	97
HI16082N2□T	2.2	2.2	2.2	2.2	2.2	2.2	2.2	14	36	46	50	73	42	101
HI16082N7□T	2.7	2.7	2.7	2.7	2.7	2.7	2.7	14	36	47	45	72	45	94
HI16083N3□T	3.3	3.3	3.3	3.3	3.5	3.5	3.6	14	37	47	50	67	47	77
HI16083N9□T	3.9	3.9	3.9	3.9	4.0	4.0	4.1	15	36	46	49	66	48	81
HI16084N7□T	4.7	4.6	4.6	4.7	4.9	4.9	5.1	15	39	50	53	70	53	80
HI16085N6□T	5.6	5.5	5.6	5.6	6.1	6.3	6.7	15	39	50	54	67	52	69
HI16086N8□T	6.8	6.7	6.7	6.8	7.3	7.5	7.9	15	38	49	52	66	53	66
HI16088N2□T	8.2	8.1	8.2	8.3	9.5	9.9	11.0	16	37	48	50	59	49	54
HI160810N□T	10.0	9.9	10.1	10.2	11.7	12.3	13.9	16	39	49	52	60	50	52
HI160812N□T	12.0	12.2	12.6	12.8	16.6	18.4	24.4	16	36	46	48	47	39	31
HI160815N□T	15.0	15.1	15.6	15.9	21.0	23.4	31.9	17	40	50	52	49	41	31
HI160818N□T	18.0	18.1	18.9	19.3	27.7	32.2	52.2	17	39	48	50	43	35	21
HI160822N□T	22.0	22.3	23.8	24.6	45.7	63.5	521.1	17	39	46	47	29	19	1
HI160827N□T	27.0	27.8	30.3	31.6	85.8	191.2	-	18	39	45	46	19	8	-
HI160833N□T	33.0	34.9	38.8	40.9	-	-	-	18	39	43	43	-	-	-
HI160839N□T	39.0	41.3	47.7	51.2	-	-	-	19	36	39	37	-	-	-
HI160847N□T	47.0	50.0	58.9	64.0	-	-	-	17	34	36	34	-	-	-
HI160856N□T	56.0	62.0	77.7	87.5	-	-	-	19	35	34	31	-	-	-
HI160868N□T	68.0	76.8	103.2	121.7	-	-	-	18	33	29	25	-	-	-
HI160882N□T	82.0	96.5	145.3	187.2	-	-	-	19	32	25	20	-	-	-
HI1608R10□T	100.0	123.7	222.4	343.5	-	-	-	18	30	19	12	-	-	-
HI1608R12□T	120.0	156.0	355.0	-	-	-	-	19	28	14	-	-	-	-
HI1608R15□T	150.0	227.9	-	-	-	-	-	18	21	-	-	-	-	-
HI1608R18□T	180.0	336.8	-	-	-	-	-	17	17	-	-	-	-	-
HI1608R22□T	220.0	520.7	-	-	-	-	-	16	13	-	-	-	-	-
HI1608R24□T	240.0	-	-	-	-	-	-	16	-	-	-	-	-	-
HI1608R27□T	270.0	-	-	-	-	-	-	16	-	-	-	-	-	-
HI1608R33□T	330.0	-	-	-	-	-	-	14	-	-	-	-	-	-
HI1608R39□T	390.0	-	-	-	-	-	-	14	-	-	-	-	-	-
HI1608R47□T	470.0	-	-	-	-	-	-	13	-	-	-	-	-	-

Typical Electrical Characteristic

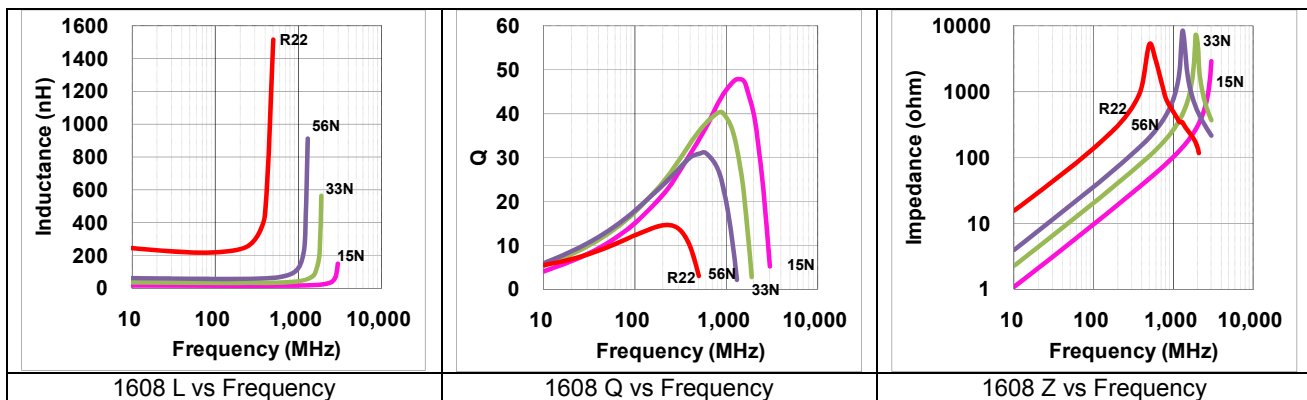



Testing Condition & Requirements

No.	Item	Test Condition	Requirements																
1	Appearance	Inductors shall be visually inspected for visible evidence of defect.	No harmful defect for piratical use.																
2	Inductance	a. Temperature: 25+/- 3°C b. Relative Humidity: 45 to 75%RH c. Measuring equipment and fixture: 0603(0201) HP 4287+16196C 1005(0402) HP 4287+16193A 1608(0603) HP 4291+16192A	Within specified tolerance.																
3	Q Value	a. Temperature: 25+/- 3°C b. Relative Humidity: 45 to 75%RH c. Measuring equipment and fixture: 0603(0201) HP 4287+16196C 1005(0402) HP 4287+16193A 1608(0603) HP 4291+16192A	In accordance with electrical specification.																
4	DC Resistance	a. Temperature: 25+/- 3°C b. Relative Humidity: 45 to 75%RH c. Measuring equipment: HP 4338	In accordance with electrical specification.																
5	Dimension	Dimension shall be measured with caliper or micrometer	In accordance with dimension specification.																
6	Solder-ability	Immerse a test sample into a methanol solution containing rosin and immerse into SAC305(Sn96.5Ag3.0Cu0.5) solder of 245±5°C for 3±1 seconds.	90% of the termination is to be soldered evenly and continuously.																
7	Resistance to Soldering Heat	Immerse a test sample into a methanol solution containing resin, preheat it at 150 to 180°C for 2~3 minutes and immerse into molten solder of 260+/-5°C for 10+/-1 second so that both terminal electrodes are completely submerged. After this test samples shall be taken out and measured after kept at room temperature for 2 to 3 hours.	No visible damage Remained terminal electrode : 70% min. Inductance variation within 30%																
8	Bending Strength	Solder the chip to test jig then apply a force in the direction shown in below. The soldering shall be done with the reflow method and shall be conducted with care so that the soldering is uniform and free of defects such as heat shock. <p style="text-align: center;">t : 1.6mm(0.8mm for 0603&1005 size) Fig. a.</p> <p style="text-align: center;">Fig. b.</p> <table border="1" style="margin-left: auto; margin-right: auto;"> <thead> <tr> <th>Size</th> <th>a</th> <th>b</th> <th>C</th> </tr> </thead> <tbody> <tr> <td>0603</td> <td>0.3</td> <td>0.9</td> <td>0.3</td> </tr> <tr> <td>1005</td> <td>0.4</td> <td>1.5</td> <td>0.5</td> </tr> <tr> <td>1608</td> <td>1.0</td> <td>3.0</td> <td>1.2</td> </tr> </tbody> </table>	Size	a	b	C	0603	0.3	0.9	0.3	1005	0.4	1.5	0.5	1608	1.0	3.0	1.2	No mechanical damage shall be observed.
Size	a	b	C																
0603	0.3	0.9	0.3																
1005	0.4	1.5	0.5																
1608	1.0	3.0	1.2																

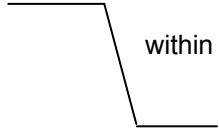

No.	Item	Test Condition	Requirements
9	Thermal Shock	<p>Solder a test sample to printed circuit board, and conduct 5 cycles of test under the conditions shown as below.</p> <p>0603 & 1005 operating temp. range: -55~125°C 1608 operating temp. range: -40~85°C</p> <p>Cycle: Maximum operating temp. / (30+/-3min)</p>  <p>Minimum operating temp. (30+/-3min)</p>	<p>No visible damage Inductance variation within 10% Q variation within 20%</p>
10	High Humidity State Life Test	<p>Keep a test sample in an atmosphere with a temperature of 40±2°C, 90~95%RH for 500 +24/-0 hours. After the removal from test chamber, 2 to 3 hours of recovery under standard condition, and measurement shall be made after 24±2 hrs of recovery under standard condition.</p>	<p>No visible damage. Inductance variation within 10%. Q variation within 20%.</p>
11	High Humidity Load Life Test	<p>Solder a test sample to printed circuit board then keep the test sample in an atmosphere with a temperature of 40±2°C, 90~95%RH for 500+24/-0 hours while supplying the rated current. After the removal from test chamber, 2 to 3 hours of recovery under standard condition, and measurement shall be made after 24±2 hrs of recovery under standard condition.</p>	<p>No visible damage. Inductance variation within 10%. Q variation within 20%.</p>
12	High Temperature State Life Test	<p>Keep a test sample in an atmosphere with a temperature of 85±2°C for 500±12 hours. After the removal from test chamber, 2 to 3 hours of recovery under standard condition, and measurement shall be made after 24+/-2 hrs of recovery under standard condition.</p>	<p>No visible damage. Inductance variation within 10%. Q variation within 20%.</p>
13	High Temperature Load	<p>Solder a test sample to printed circuit board then keep the test sample in an atmosphere with a temperature of 85±2°C for 500±12 hours while supplying the rated current. After the removal from test chamber, 2 to 3 hours of recovery under standard condition, and measurement shall be made after 24±2 hrs of recovery under standard condition.</p>	<p>No visible damage. Inductance variation within 10%. Q variation within 20%.</p>

Reflow Profile Chart (Reference)

● **Soldering Profile for SMT Process with Lead Free Solder Paste.**

The rate of preheat should not exceed 4°C/sec and a target of 2°C/sec is preferred. Ceramic chip components should be preheated to within 100 to 130 °C of the soldering.

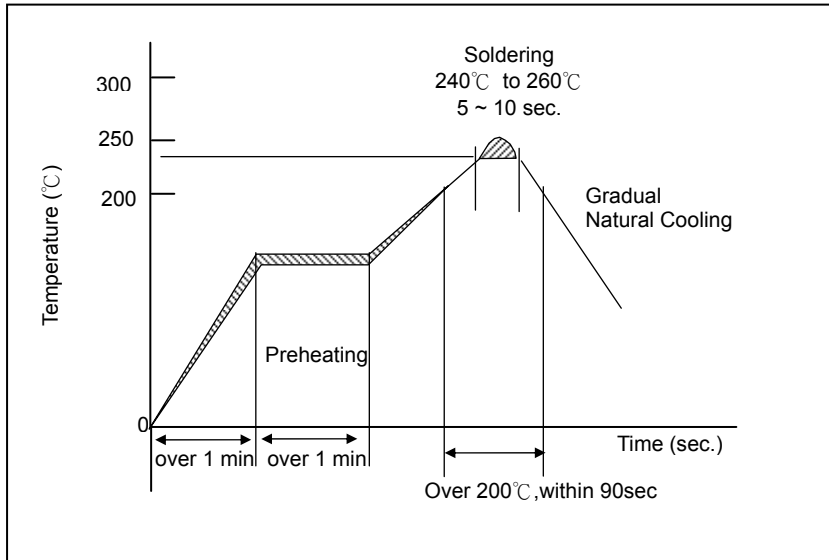

● **Soldering Profile for SMT Process with SnPb Solder Paste.**

The rate of preheat should not exceed 4°C/sec and a target of 2°C/sec is preferred. Ceramic chip components should be preheated to within 100 to 130 °C of the soldering.

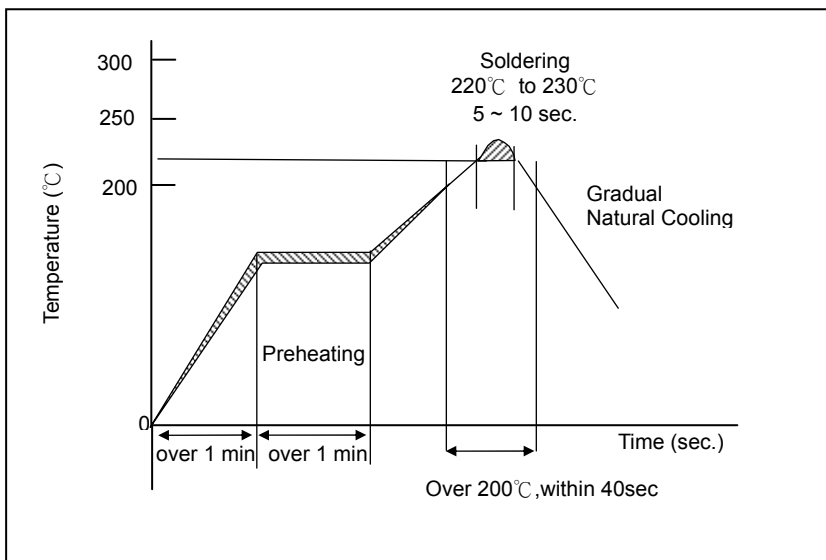

Packaging Specification

- Paper Tape

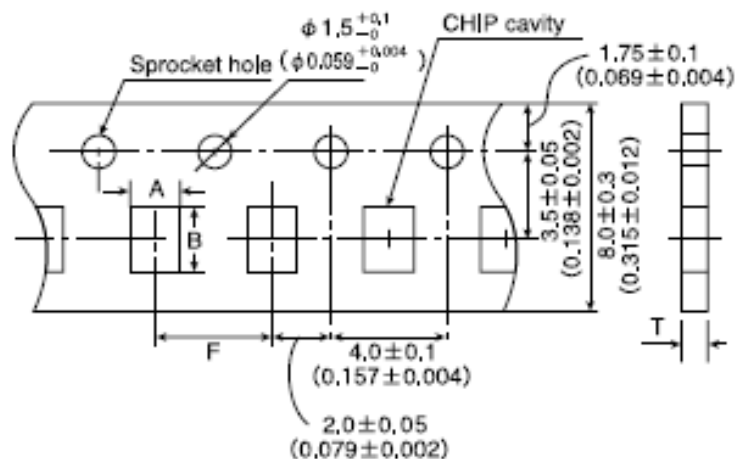

	Symbol	Product Size Code	
		1608(0603) (mm)	2012(0805) (mm)
Chip cavity	A	1.0 ± 0.2	1.5 ± 0.2
	B	1.8 ± 0.2	2.3 ± 0.2
Insertion Pitch	F	4.0 ± 0.1	4.0 ± 0.1
Tape Thickness	T	1.1 max	0.8 max

● Embossed Tape

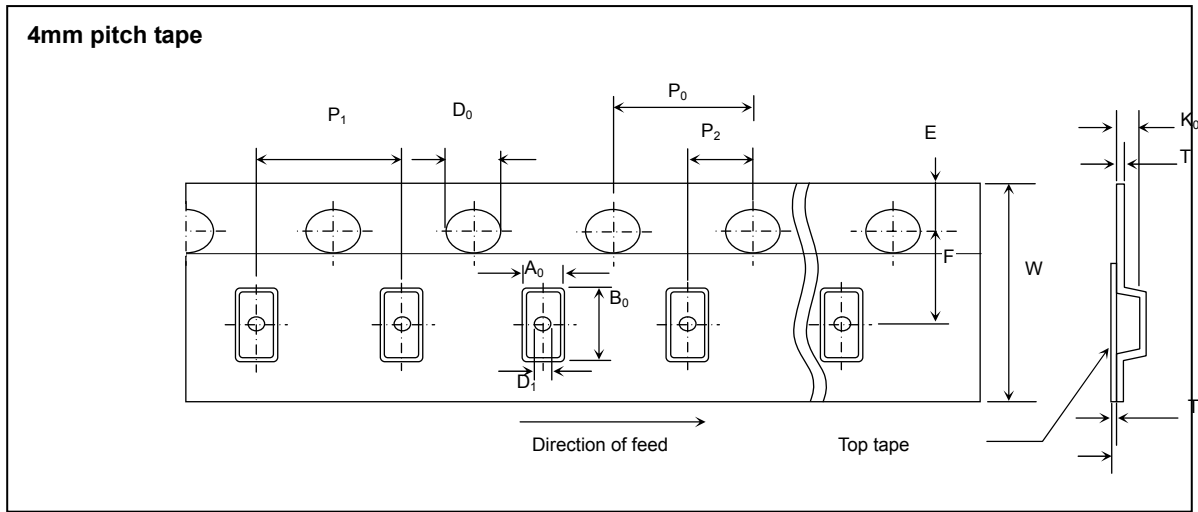

Symbol	2012 (0805)	2016 (0806)	2520 (1008)
P_1	4 ± 0.1	4 ± 0.1	4 ± 0.1
P_0	4 ± 0.1	4 ± 0.1	4 ± 0.1
P_2	2 ± 0.05	2 ± 0.05	2 ± 0.05
A_0	1.55 ± 0.2	1.8 ± 0.1	2.3 ± 0.1
B_0	2.3 ± 0.2	2.2 ± 0.1	2.8 ± 0.1
K_0	1.3 ± 0.1	1.3 ± 0.1	1.4 ± 0.1
W	8 ± 0.3	8 ± 0.3	8 ± 0.3
E	1.75 ± 0.1	1.75 ± 0.1	1.75 ± 0.1
F	3.5 ± 0.05	3.5 ± 0.05	3.5 ± 0.05
D_0	1.5 (+0.1/-0.0)	1.5 (+0.1/-0.0)	1.5 (+0.1/-0.0)
T	0.3 max	0.3 max	0.3 max

Unit: mm/(inch)

● Reel Specifications

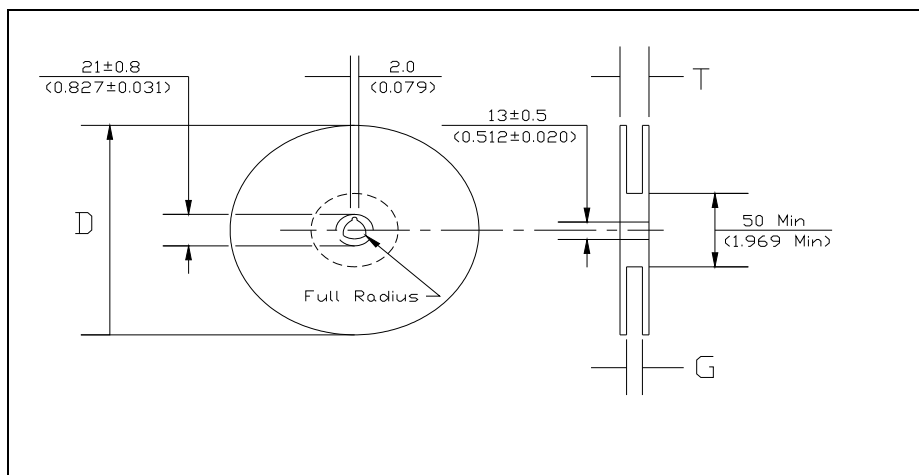

Tape Width (mm)	G (mm)	T max.(mm)	D (mm)
8	10.0 ± 1.5	14.5	178 ± 2.0

- **Peel Strength of Top Cover Tape**

The peel speed shall be about 300 mm/min.

The peel strength of top cover tape shall be between 0.1 to 1.0N.

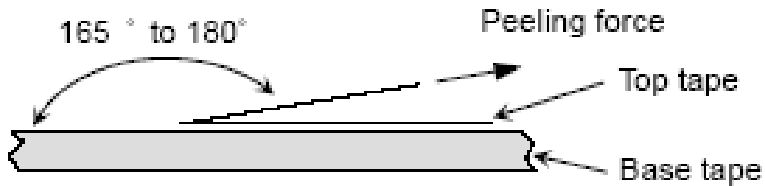

Cautions

- **Storage**

1. The inductor shall be packaged in carrier tapes.
2. To keep storage place temperature from +5 to 35°C, humidity from 45 to 70% RH.
3. The storage atmosphere must be free of gas containing sulfur and chlorine. Also, avoid exposing the product to saline moisture. If the product is exposed to such atmospheres, the terminals will oxidize and solderability will be affected.
4. The solder ability is assured for 12 months from our final inspection date if the above storage condition is followed.

- **Handling**

Inductor should be handled with care to avoid contamination or damage. The use of vacuum pick-up or plastic tweezers is recommended for manual placement. Tape and reeled packages are suitable for automatic pick and placement machine.

X-ON Electronics

Largest Supplier of Electrical and Electronic Components

Click to view similar products for [Fixed Inductors](#) category:

Click to view products by [Darfon](#) manufacturer:

Other Similar products are found below :

[MLZ1608M6R8WTD25](#) [MLZ1608N6R8LT000](#) [MLZ1608N3R3LTD25](#) [MLZ1608N3R3LT000](#) [MLZ1608N150LT000](#)

[MLZ1608M150WTD25](#) [MLZ1608M3R3WTD25](#) [MLZ1608M3R3WT000](#) [MLZ1608M150WT000](#) [MLZ1608A1R5WT000](#)

[MLZ1608N1R5LT000](#) [B82432C1333K000](#) [PCMB053T-1R0MS](#) [PCMB053T-1R5MS](#) [PCMB104T-1R5MS](#) [CR32NP-100KC](#) [CR32NP-](#)

[151KC](#) [CR32NP-180KC](#) [CR32NP-181KC](#) [CR32NP-1R5MC](#) [CR32NP-390KC](#) [CR32NP-3R9MC](#) [CR32NP-680KC](#) [CR32NP-820KC](#)

[CR32NP-8R2MC](#) [CR43NP-390KC](#) [CR43NP-560KC](#) [CR43NP-680KC](#) [CR54NP-181KC](#) [CR54NP-470LC](#) [CR54NP-820KC](#) [CR54NP-8R5MC](#)

[MGDQ4-00004-P](#) [MGDU1-00016-P](#) [MHL1ECTTP18NJ](#) [MHL1JCTTD12NJ](#) [PE-51506NL](#) [PE-53601NL](#) [PE-53630NL](#) [PE-53824SNLT](#) [PE-](#)

[62892NL](#) [PE-92100NL](#) [PG0434.801NLT](#) [PG0936.113NLT](#) [PM06-2N7](#) [PM06-39NJ](#) [HC2LP-R47-R](#) [HC2-R47-R](#) [HC3-2R2-R](#) [HC8-1R2-R](#)