

PART NAME: KNOB

SCALE: 2:1

DATE: 8/13/13

DR. BY: JAM



DESIGNERS & MANUFACTURERS
OF KNOBS, HANDLES, CAPS &
CUSTOM PLASTIC COMPONENTS

P/N 1221-L

THIS DRAWING IS THE PROPERTY OF DAVIES MOLDING COMPANY, IS SUBMITTED SOLELY AS A DESIGN OR ENGINEERING PROJECT.
WE ACCEPT NO RESPONSIBILITY WHATSOEVER FOR THE PRACTICAL APPLICATION OF THE PIECES MADE TO THIS DESIGN.

MOLD #	1221
CAVITY	1221
CORE	1221
PIN	1221-L

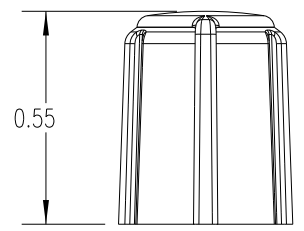
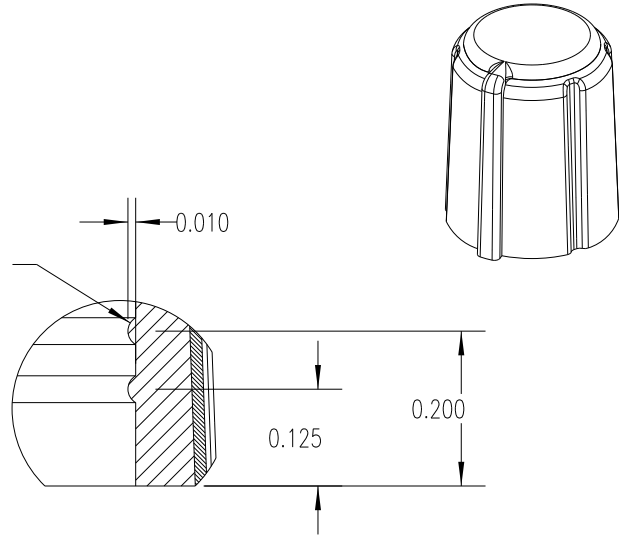
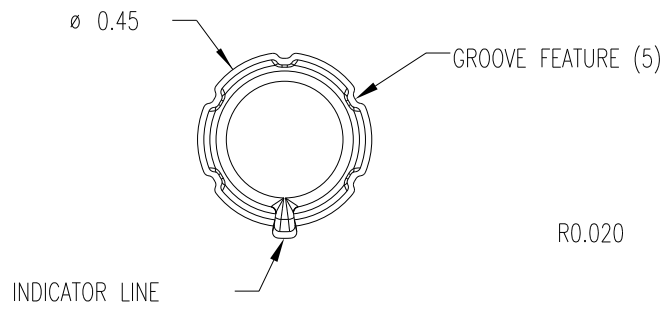

DETAIL A
SCALE 4 : 1

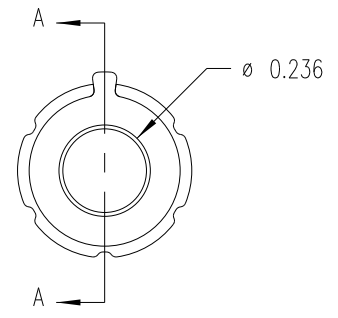
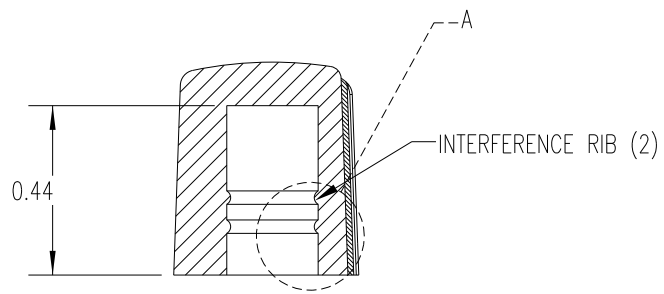

SUBSTRATE MATERIAL: POLYPROPYLENE (CLD)
COLOR: WHITE (PC23083)

OVERMOLD MATERIAL: TPE (TPE3)
COLOR: BLACK

TOLERANCES: UNLESS OTHERWISE SPECIFIED	DO NOT SCALE DRAWING				
DECIMALS: X.XXX ± .005 X.XX ± .015	MM: X.XX ± 0.15MM X.X ± 0.4MM				
FRACTIONS ± 1/64	ANG. ± 1°	CHANGES			

X-ON Electronics

Largest Supplier of Electrical and Electronic Components

Click to view similar products for [Knobs & Dials](#) category:

Click to view products by [Davies Molding](#) manufacturer:

Other Similar products are found below :

[8519](#) [8547](#) [8573](#) [11K5015-EMNB](#) [11K5019-ECNB](#) [11K5020-KLAB](#) [11K5048-KMNB](#) [11K5014-EMNB](#) [11K5015-EMNG](#) [11K5019-EMNB](#) [1770](#) [P400S-08-D6-N](#) [K6510](#) [PKJ50B18](#) [42000B38](#) [420114B14](#) [5006](#) [KS700B14](#) [411](#) [420037B14](#) [8517](#) [8545](#) [8546](#) [8572](#) [H-516-3A](#) [P861H-0X-S6](#) [8544](#) [11K5014-JMNG](#) [11K5014-KMNG](#) [11K5014-ECNG](#) [5700E](#) [5002-5](#) [52-928.40](#) [5003-5](#) [11K5019-KCNG](#) [11K5028-KCNG](#) [02000-11A-2](#) [02000-4-1](#) [0025DF](#) [G813512LADUS-0](#) [2810-Y](#) [3009CC](#) [3025BA](#) [YME IP 12 D](#) [YME IP 01 A](#) [YME IP 12 H](#) [YME IP 12L-U](#) [YME IP 16 I](#) [YME IP 01 B](#) [YME IP 16 N](#)