

PART NAME: GROMMET

SCALE: 6:1

DATE: 9/19/16

DR. BY: MK



DESIGNERS & MANUFACTURERS
OF KNOBS, HANDLES, CAPS &
CUSTOM PLASTIC COMPONENTS

P/N

5104

THIS DRAWING IS THE PROPERTY OF DAVIES MOLDING COMPANY, IS SUBMITTED SOLELY AS A DESIGN OR ENGINEERING PROJECT.
WE ACCEPT NO RESPONSIBILITY WHATSOEVER FOR THE PRACTICAL APPLICATION OF THE PIECES MADE TO THIS DESIGN.

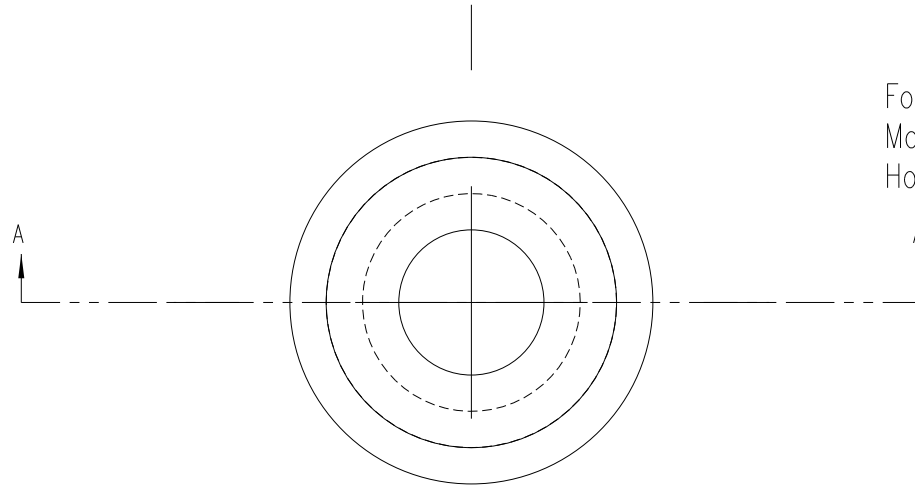

For use with panels of:
Max Thickness = 0.063"
Hole Dia. = 0.187"

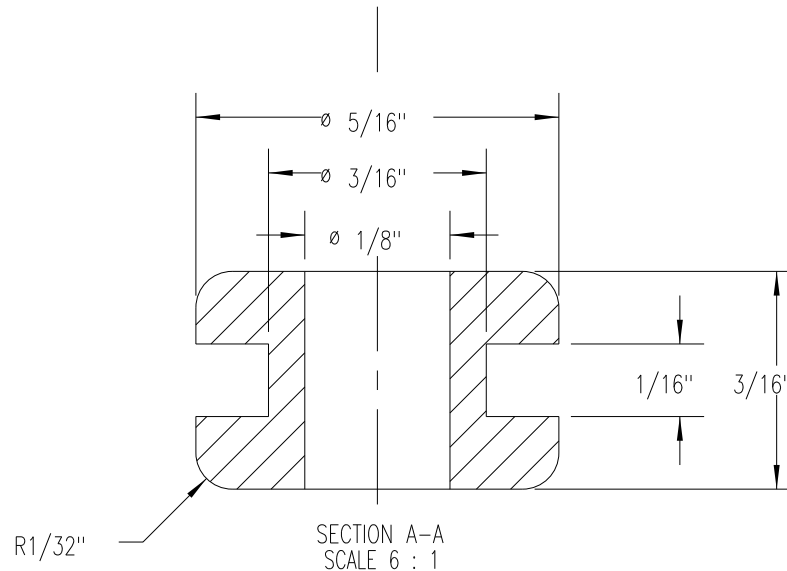

MATERIAL: NBR
COLOR: BLACK

TOLERANCES: UNLESS OTHERWISE SPECIFIED	DO NOT SCALE DRAWING				
DECIMALS: X.XXX ± .005 X.XX ± .015	MM: X.XX ± 0.15MM X.X ± 0.4MM				
FRACTIONS ± 1/64	ANG. ± 1°	CHANGES			

X-ON Electronics

Largest Supplier of Electrical and Electronic Components

Click to view similar products for [Grommets & Bushings](#) category:

Click to view products by [Davies Molding](#) manufacturer:

Other Similar products are found below :

[M10-036565-101](#) [M10-036565-143](#) [M10-036565-183](#) [M10-036565-244](#) [205339-4](#) [M10-036565-122](#) [M10-036565-163](#) [3-1991136-0](#) [561-FGUP0850B](#) [561-MP13716](#) [561-FGUP0400N](#) [1398081-1](#) [1301800320](#) [M10-036565-232](#) [2298](#) [2407](#) [2141-P](#) [2417-P](#) [2917-P](#) [3108-P](#) [2871-P](#) [100187](#) [100188](#) [100216](#) [1301800412](#) [FEM 27-35](#) [100238](#) [100244](#) [100084](#) [103584](#) [103608](#) [104344](#) [103577](#) [103589](#) [104335](#) [104338](#) [SB-10](#) [SB-14](#) [SB-22](#) [SB-8](#) [SB-8S](#) [LTG-43021](#) [2000](#) [2010](#) [2017](#) [2020](#) [2030](#) [2089](#) [2137](#) [2201](#)