

TOP VIEW

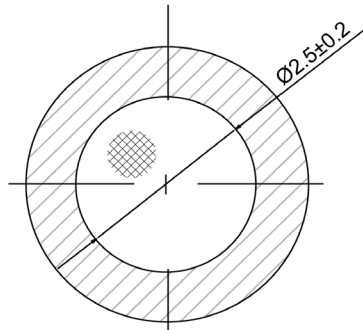

SIDE VIEW

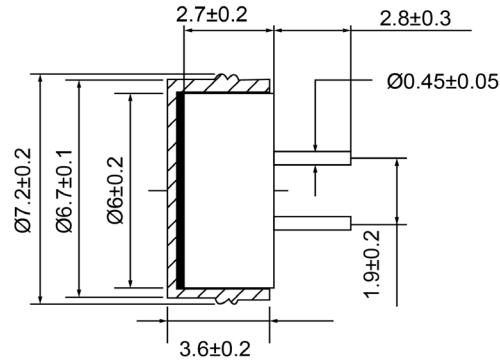

BOTTOM VIEW

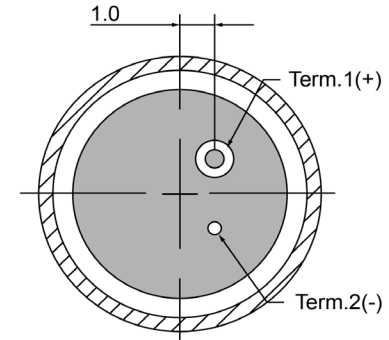

Specifications			Notes	Revision History					
Description	Value	Unit		Version	Description		Date	Approved	
Directivity	Omnidirectional		1) All dimensions are in mm unless otherwise noted 2) All parts meet RoHS  DB UNLIMITED	1	Released from Engineering		10/21/2013	J.S	
Technology	Electret Condenser								
Sensitivity	-40	(dB)							
Frequency Range	50 ~ 16,000	(Hz)							
Rated Voltage	2	(V)							
Output Impedance	2,200	(Ohm)							
Connection Method	PC Pins								
Voltage Range	2 ~ 10	(V)							
Max Rated Current	0.5	(mA)							
Minimum Signal to Noise Ratio	>60	(dB)							
Operating Temperature	-20 ~ +60	°C							
Storage Temperature	-25 ~ +70	°C							
				Drawn by	Date	Checked by	Date	Approved by	Date
				A.B.	10/21/2013	C.E.	10/21/2013	J.S	10/21/2013
				Electret Condenser Microphone			MO064002-3		

X-ON Electronics

Largest Supplier of Electrical and Electronic Components

Click to view similar products for [Microphones](#) category:

Click to view products by [DB Unlimited](#) manufacturer:

Other Similar products are found below :

[BCM4013OLFC-42-JST-ZHR-2](#) [TO38-30702-B20](#) [FB-EI-31809-000](#) [SPM04C-38/1186-T/R](#) [BCM4013OSBC-42 LF](#) [TOW-1242P-R](#)
[BCM9745-44](#) [BCM9765](#) [BCM9767P](#) [LD-MC-0905P](#) [LD-MC-6035](#) [LD-MC-9765](#) [PMOF-9745S-42UQ](#) [ROM-2235L-HD-R](#) [CMC-4015-130T](#) [CMC-6050-40T](#) [CMC-6035-130T](#) [CMC-6015-47P](#) [BCM9745P-44](#) [BCM9767-42](#) [254-ECM644-RO](#) [LD-MC-4011](#) [LD-MC-6027](#) [LD-MC-6035P](#) [LD-MC-6035W](#) [LD-MC-9765P](#) [LD-MC-9765W](#) [FG-23629-D65](#) [PNR-23539-000](#) [254-FP270-RO](#) [BCM9765P-44](#) [CMC-5042PF-AC](#) [CMC-6010-42L100](#) [CMC-9745-L100](#) [CMC-3015-44T](#) [CMC-4015-25T](#) [CMC-6013-38T](#) [CMC-6022-37L100](#) [CMC-6027-24T](#) [CMC-6027-32T](#) [GMI4522P-2C-30db](#) [GMI4522P-2C-50db](#) [GMI4522P-2C-52db](#) [GMI6027P-2C66DB](#) [GMA3526H10-B26](#) [GMA4030H11-F26](#)
[GMI4015-32DB](#) [GMI4015-40DB](#) [GMI4015P-36DB](#) [GMI4015P-46DB](#)