

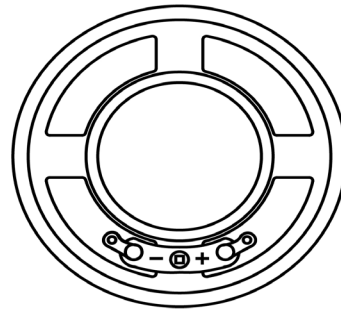

TOP VIEW

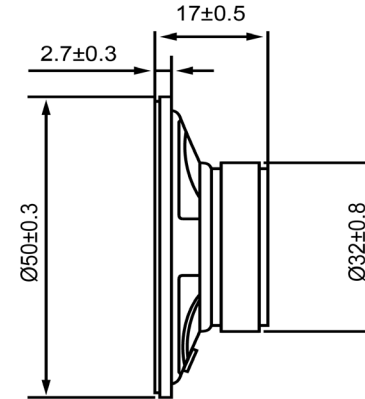

SIDE VIEW



Specifications			Notes	Revision History						
Description	Value	Unit		Version	Description		Date	Approved		
Shape	Round		1) All dimensions are in mm unless otherwise noted 2) All parts meet RoHS  DB UNLIMITED	1	Released from Engineering		2/5/2014	J.S.		
Resonant Frequency	450	(Hz)								
Frequency Range	450 ~ 4,000	(Hz)								
SPL @ 10cm	93	(dBA)								
Impedance	8	(Ohm)								
Cone Material	Paper									
Nominal Power	0.25	(W)								
Max Power	0.5	(W)								
Mount Type	Flush Mount									
Operating Temperature	-20 ~ +60	°C			Drawn by	Date	Checked by	Date	Approved by	Date
Storage Temperature	-30 ~ +70	°C			G.W.	1/27/2014	C.E.	2/5/2014	J.S.	2/5/2014
Weight	50	(g)			Dynamic Speaker			SP500408-2		

X-ON Electronics

Largest Supplier of Electrical and Electronic Components

Click to view similar products for [Speakers & Transducers](#) category:

Click to view products by [DB Unlimited](#) manufacturer:

Other Similar products are found below :

[FC-30814-P127](#) [AS02832MR-2-R](#) [PB-1220PE](#) [PB-2015PQ](#) [900-00001](#) [AB2025B-LW50-R](#) [SWFK-31736-000](#) [PT-2065FW](#) [PT-4175W](#) [AT-2830-TW-LW35-R](#) [ED-30761-000](#) [CI-30120-A42](#) [SMT-0440-T-2-R](#) [PB-0927PQ](#) [BF-7083-000](#) [SMS2020-08H4.5 LF](#) [BDT1717-08H6.5W56MLF](#) [GSPK1003PN-8R0.2W-L100](#) [GSPK151103TN-8R0.2W](#) [GSPK2014035PN-8R0.5W-L100](#) [AS03608MR-LW100-R](#) [24520](#) [SMT-0540-S-2-R](#) [1450069](#) [9091653](#) [9091661](#) [IPS-G6000-5](#) [9090231](#) [FS50MS0820-H9.7](#) [FS4014-4-2W](#) [PBM4-13.B29R.A115.0663](#) [PBM4-13.B31R.A115.0663](#) [PBM4-13.B33R.A115.0663](#) [PBM4-13.B35R.A115.0663](#) [A-10-6-BG360-HD1Z-GA-M4Z-ZW](#) [A-10-6-BG410-HD1Z-AA-AGZ-ZW](#) [A-10-6-BG410-HD1Z-AA-M4Z-ZW](#) [A-10-6-BG410-HD1Z-FC-AGZ-ZW](#) [A-10-6-BG410-HD1Z-GA-M4Z-ZW](#) [A-10-6-BG310-HD1Z-AA-AGZ-ZW](#) [A-10-6-BG310-HD1Z-AA-M4Z-ZW](#) [A-10-6-BG310-HD1Z-GA-M4Z-ZW](#) [A-10-6-BG316-HD1Z-AA-M4Z-ZW](#) [A-10-6-BG325-HD1Z-AA-AGZ-ZW](#) [A-10-6-BG325-HD1Z-AA-M4Z-ZW](#) [A-10-6-BG340-HD1Z-AA-AGZ-ZW](#) [A-10-6-BG340-HD1Z-AA-M4Z-ZW](#) [A-10-6-BG340-HD1Z-GA-M4Z-ZW](#) [A-10-6-BG360-GT1Z-AA-M4Z-ZW](#) [A-10-6-BG360-HD1Z-AA-AGZ-ZW](#)