

TOP VIEW

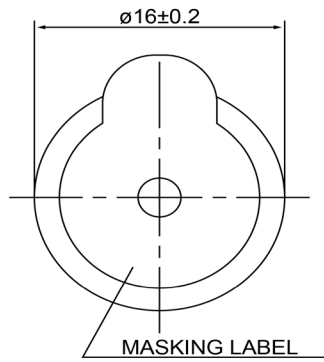

SIDE VIEW

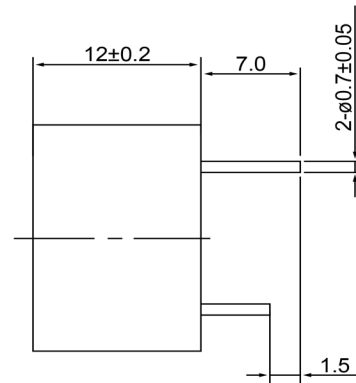

BOTTOM VIEW

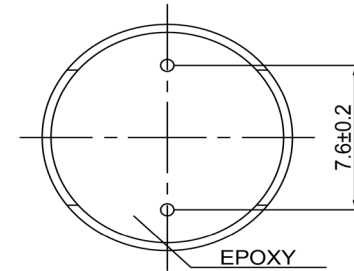

Specifications			Notes	Revision History									
Description	Value	Unit		Version	Description	Date	Approved	Drawn by	Date	Checked by	Date	Approved by	Date
Technology	Electro-Mechanical		1) All dimensions are in mm unless otherwise noted 2) All parts meet RoHS	1	Released from Engineering	10/21/2013	J.S	A.B.	10/21/2013	C.E.	10/21/2013	J.S	10/21/2013
Resonant Frequency	2,048	(Hz)											
Rated Voltage	12	(V)											
SPL @ 10cm	85	(dBA)											
Coil Resistance	135	(ohm)											
Mount Type	Thru Hole												
Voltage Range	6 ~ 18	(V)											
Max Rated Current	35	(mA)											
Housing Material	NORYL												
Operating Temperature	-30 ~ +70	°C											
Storage Temperature	-40 ~ +85	°C											
Weight	5	(g)											



Electro-Mechanical Transducer

TE162012-6

X-ON Electronics

Largest Supplier of Electrical and Electronic Components

Click to view similar products for [Speakers & Transducers](#) category:

Click to view products by [DB Unlimited](#) manufacturer:

Other Similar products are found below :

[FC-30814-P127](#) [AS02832MR-2-R](#) [PB-1220PE](#) [PB-2015PQ](#) [900-00001](#) [AB2025B-LW50-R](#) [SWFK-31736-000](#) [PT-2065FW](#) [PT-4175W](#) [AT-2830-TW-LW35-R](#) [ED-30761-000](#) [CI-30120-A42](#) [SMT-0440-T-2-R](#) [PB-0927PQ](#) [BF-7083-000](#) [CTX323B220](#) [SMS2020-08H4.5 LF](#) [BDT1717-08H6.5W56MLF](#) [GSPK1003PN-8R0.2W-L100](#) [GSPK151103TN-8R0.2W](#) [GSPK2014035PN-8R0.5W-L100](#) [AS03608MR-LW100-R](#) [24520](#) [SMT-0540-S-2-R](#) [1450069](#) [9091653](#) [9091661](#) [IPS-G6000-5](#) [9090231](#) [FS50MS0820-H9.7](#) [FS4014-4-2W](#) [PBM4-13.B29R.A115.0663](#) [PBM4-13.B31R.A115.0663](#) [PBM4-13.B33R.A115.0663](#) [PBM4-13.B35R.A115.0663](#) [A-10-6-BG360-HD1Z-GA-M4Z-ZW](#) [A-10-6-BG410-HD1Z-AA-M4Z-ZW](#) [A-10-6-BG410-HD1Z-FC-AGZ-ZW](#) [A-10-6-BG410-HD1Z-GA-M4Z-ZW](#) [A-10-6-BG310-HD1Z-AA-AGZ-ZW](#) [A-10-6-BG310-HD1Z-AA-M4Z-ZW](#) [A-10-6-BG310-HD1Z-GA-M4Z-ZW](#) [A-10-6-BG316-HD1Z-AA-M4Z-ZW](#) [A-10-6-BG325-HD1Z-AA-AGZ-ZW](#) [A-10-6-BG325-HD1Z-AA-M4Z-ZW](#) [A-10-6-BG340-HD1Z-AA-AGZ-ZW](#) [A-10-6-BG340-HD1Z-AA-M4Z-ZW](#) [A-10-6-BG340-HD1Z-GA-M4Z-ZW](#) [A-10-6-BG360-GT1Z-AA-M4Z-ZW](#) [A-10-6-BG360-HD1Z-AA-AGZ-ZW](#)