

承認書

SPECIFICATION FOR APPROVAL

Customer Name: 2144

Description Part No.: _____

Customer Part No.: _____

Sample No.: _____

DDY Part No.: SFE252012S-

DRAWING		
MADE	CHECKED	APPROVED
王海玲	赵万虎	肖中华
DATE: 2023年4月22日		

CUSTOMER APPROVE



惠州市德立电子有限公司
HUI ZHOU DE LI ELECTRONICS CO., LTD

廣東省博羅縣洲際工業園梅園三路
NO.3 MEI YUAN ROAD,ZHOU JI INDUSTRIAL AREA,BOLUO COUNTY
GUANGDONG

電話：15970768093 13640935893

傳真：0752-6207969

郵編：516100

Http: www.ddycoils.com



1. Scope

This specification applies to the SFE252012 Series of wire wound SMD power inductor.

2.PRODUCT IDENTIFICATION

SFE 252012S - 1R5 □ - □

(1) (2) (3) (4) (5)

(1) .Series name (产品品名) (2) .Dimensions (产品尺寸)

(3) .Inductance value (电感值) (4) .Tolerance (误差值)

1R5: 1.5μH 221: 220μH

M: ±20%; N: ±30%

(6) .Environmental status (环保状态)

LF- Lead free; HF-Halogen free.

FP-Free red phosphor.

3. Electrical Characteristics

Please refer to Item 5.

- 1). Operating temperature range (individual chip without packing): -40°C ~ +125°C .
- 2). Storage temperature range (packaging conditions): -40°C ~ +85°C and RH 70% (Max.).
- 3). Rating DC current: Temperature rise(ΔT) is 40°C approximately at Irms.
- 4). Saturation DC current: Inductance drop approximately 30% of L₀ at Isat.

4. Shape and Dimensions (Unit:mm)

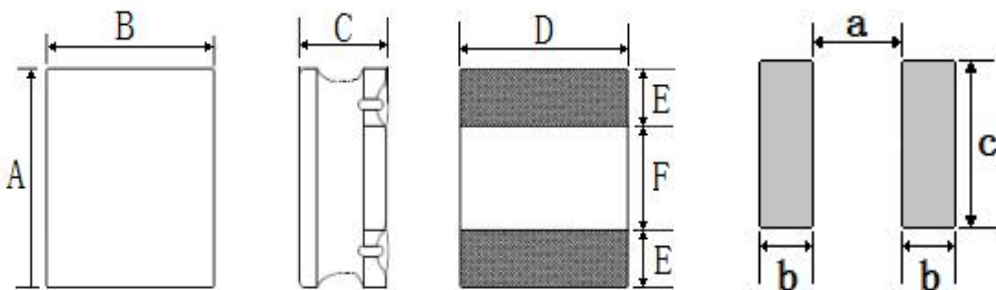

Recommended Land Pattern

Series	A	B	C	D	E	F	a Typ.	b Typ.	c Typ.
SFE252012S	2.5±0.3	2.0±0.3	1.2 Max.	2.0±0.2	0.75 Typ.	1.0 Typ.	0.80	0.90	2.2



5. Electrical Characteristics										
NO	DDY CODE	Part Number	Inductance	DC Resistance		Isat(A)		Irms(A)		Marking
			100KHz/1.0V	Max.	Typ.	Max.	Typ.	Max.	Typ.	
		Units	(uH)	Ω	Ω	A	A	A	A	
1		<input type="checkbox"/> SFE252012S-R24N-HF	0.24±30%	0.023	0.019	4.10	4.80	4.10	4.50	N/A
2		<input type="checkbox"/> SFE252012S-R33N-HF	0.33±30%	0.031	0.026	4.00	4.70	3.35	3.70	N/A
3		<input type="checkbox"/> SFE252012S-R47N-HF	0.47±30%	0.036	0.031	3.80	4.50	3.00	3.30	N/A
4		<input type="checkbox"/> SFE252012S-R68N-HF	0.68±30%	0.047	0.038	3.00	3.30	2.30	2.50	N/A
5		<input type="checkbox"/> SFE252012S-1R0N-HF	1.0±30%	0.060	0.050	2.25	2.50	2.30	2.60	N/A
6		<input type="checkbox"/> SFE252012S-1R2N-HF	1.2±30%	0.078	0.065	2.20	2.50	2.00	2.20	N/A
7		<input type="checkbox"/> SFE252012S-1R5N-HF	1.5±30%	0.090	0.075	2.00	2.35	1.80	2.00	N/A
8		<input type="checkbox"/> SFE252012S-1R8N-HF	1.8±30%	0.108	0.093	1.95	2.20	1.75	1.90	N/A
9		<input type="checkbox"/> SFE252012S-2R2M-HF	2.2±20%	0.108	0.093	1.75	1.90	1.75	1.90	N/A
10		<input type="checkbox"/> SFE252012S-2R7M-HF	2.7±20%	0.156	0.130	1.30	1.60	1.40	1.50	N/A
11		<input type="checkbox"/> SFE252012S-3R3M-HF	3.3±20%	0.156	0.130	1.20	1.35	1.40	1.50	N/A
12		<input type="checkbox"/> SFE252012S-4R7M-HF	4.7±20%	0.228	0.190	1.10	1.20	1.10	1.20	N/A
13		<input type="checkbox"/> SFE252012S-5R6M-HF	5.6±20%	0.330	0.255	1.00	1.10	1.00	1.15	N/A
14		<input type="checkbox"/> SFE252012S-6R8M-HF	6.8±20%	0.360	0.300	0.90	1.10	0.95	1.05	N/A
15		<input type="checkbox"/> SFE252012S-8R2M-HF	8.2±20%	0.522	0.435	0.80	0.92	0.80	0.90	N/A
16		<input type="checkbox"/> SFE252012S-100M-HF	10±20%	0.522	0.435	0.70	0.85	0.78	0.86	N/A
17		<input type="checkbox"/> SFE252012S-150M-HF	15±20%	1.000	0.700	0.60	0.70	0.50	0.60	N/A
18		<input type="checkbox"/> SFE252012S-220M-HF	22±20%	1.290	1.000	0.45	0.55	0.48	0.55	N/A
19		<input type="checkbox"/> SFE252012S-330M-HF	33±20%	1.840	1.410	0.35	0.40	0.35	0.40	N/A
20		<input type="checkbox"/> SFE252012S-470M-HF	47±20%	2.250	1.776	0.30	0.37	0.20	0.28	N/A

※Design as Customer's Requested Specifications. (可按顾客的特殊需求设计)



6. Structure (The structure of product.)

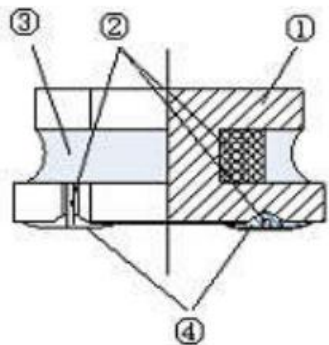

NO	Components	Material
①	Core	Ni-Zn Ferrite
②	Wire	Polyurethane system enameled copper wire
③	Magnetic Glue	Epoxy resin and magnetic powder
④	Plating	AgNiSn or FeNiCu + Sn Alloy

7. PACKAGING(unit: mm)

1.包装类型：编带装

2.包装尺寸：



13" 盘



7" 盘

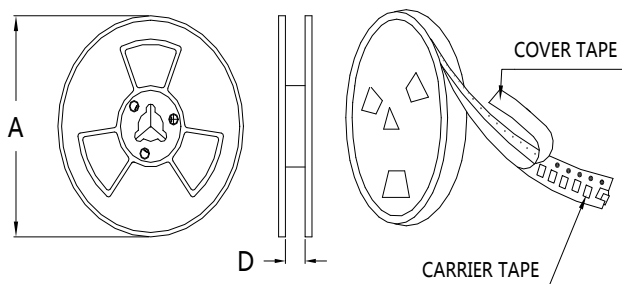

	13" 盘	7" 盘
A	$\Phi 330 \pm 2.0$	$\Phi 178 \pm 2.0$
D	8.5	

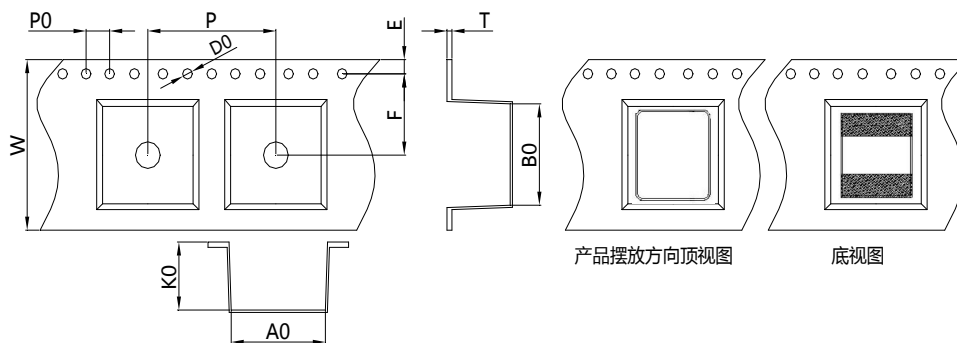

Size	Item	W	A0	B0	K0	P	T	E	F	D0	P0
252012	(mm)	8.00 ± 0.3	2.35 ± 0.2	2.65 ± 0.2	1.40 ± 0.1	4.00 ± 0.1	0.25 ± 0.1	1.75 ± 0.1	3.50 ± 0.1	1.50 ± 0.1	4.00 ± 0.2

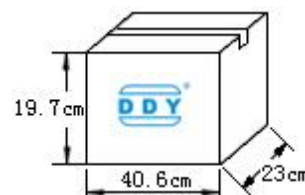
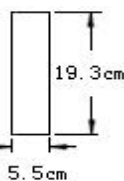
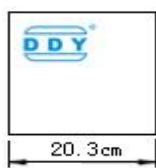

每卷	2000	Pcs
----	------	-----

每盒	4卷,共	8000	Pcs
----	------	------	-----

每箱	6盒,共	48000	Pcs
----	------	-------	-----

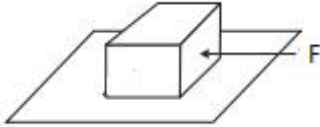

8. RELIABILITY TEST

No.	TEST ITEM	SPECIFICATION	TEST CONDITION
1	High temperature Storage test	1. No significant defects in appearance. 2. $\Delta L/L \leq 10\%$ 3. $\Delta DCR/DCR \leq 10\%$	Temperature: $125^{\circ}\text{C} \pm 5^{\circ}\text{C}$ (N: Follow the product specification for the setting.) Time : 96 ± 2 hours Place the samples for one hour at room temperature and test them within two hours
2	Low temperature Storage test	1. No significant defects in appearance. 2. $\Delta L/L \leq 10\%$ 3. $\Delta DCR/DCR \leq 10\%$	Temperature: $-40^{\circ}\text{C} \pm 5^{\circ}\text{C}$ (M: Follow the product specification for the setting) Time : 96 ± 2 hours Place the samples for one hour at room temperature and test them within two hours.
3	Humidity test	1. No significant defects in appearance. 2. $\Delta L/L \leq 10\%$ 3. $\Delta DCR/DCR \leq 10\%$	Temperature: $40 \pm 2^{\circ}\text{C}$, Humidity: $93 \pm 3\% \text{RH}$ Time : 96 ± 2 hours Place the samples for one hour at room temperature and test them within two hours
4	Solderability test	Terminals must have 95% minimum solder coverage	1. Dip pads in flux then dip in solder pot at $245 \pm 5^{\circ}\text{C}$ for 5 second. 2. Solder: lead free 3. Flux: rosin flux
5	Heat endurance of flow soldering	1. No significant defects in appearance. 2. $\Delta L/L \leq 10\%$ 3. $\Delta DCR/DCR \leq 10\%$	1. Refer to the above reflow curve and go through the reflow for twice. 2. The peak temperature : $260 + 0 / - 5^{\circ}\text{C}$
6	Vibration test	1. No significant defects in appearance. 2. No short and no open.	Apply frequency $10 \sim 55 \sim 10\text{Hz}$ and amplitude 1.5mm, 1 min/cycle in X Y and Z direction for 2 hours each. (total 6 hours)
7	Terminal strength push test	1. Applied force: 10N Duration: 10sec 2. Solder paste thickness: 0.12mm 3. Meet the above requirements without any loose termina	Solder the test samples to the PCB through 245°C reflow, apply a standard force on the side of the test samples for 10 seconds. 



9. SOLDERING CONDITIONS

Applicable soldering process to the products is refl.

9.1 Soldering Materials

(1) Solder: Sn-3.0Ag-0.5Cu

(2) Flux: Use rosin-based flux, but not strongly acidic flux (with xhlorine exceeding 0.2wt%). Do not use water-soluble flux.

9.2 Reflow Soldering Profile

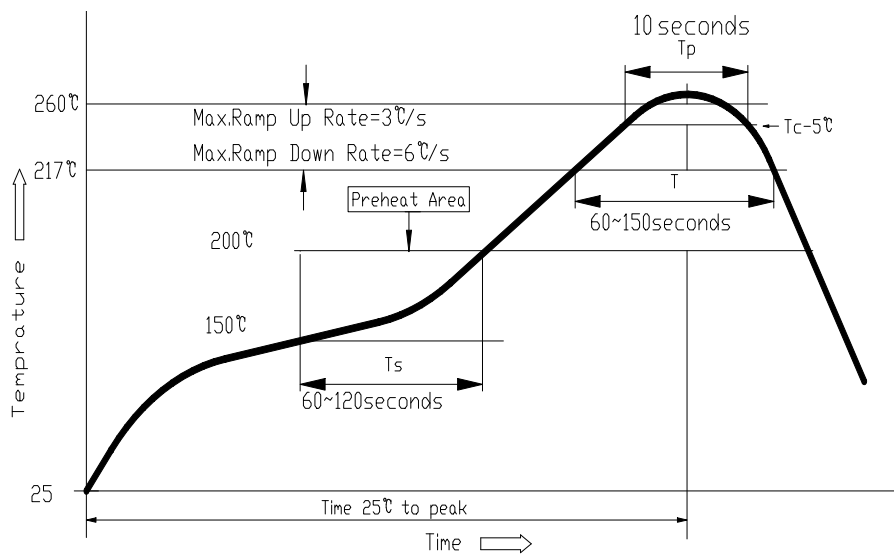

9.3 Soldering Iron

Reworking with electric soldering iron must preheating at 150°C for 1 minute is required, and do not directly touch the core with the tip of the soldering iron. The reworking soldering conditions are as follows.

- ① Temperature of soldering iron tip: 350°C;
- ② Soldering iron power output: ≤30W;
- ③ Diameter of soldering iron end: ≤1.0mm;
- ④ Soldering time: <3 s



X-ON Electronics

Largest Supplier of Electrical and Electronic Components

Click to view similar products for [Fixed Inductors](#) category:

Click to view products by [DDY](#) manufacturer:

Other Similar products are found below :

[CR32NP-100KC](#) [70F224AI](#) [MHQ1005P10NJ](#) [MHQ1005P1N0S](#) [MHQ1005P2N4S](#) [MHQ1005P3N6S](#) [MHQ1005P5N1S](#) [MHQ1005P8N2J](#)
[PE-53601NL](#) [PE-53602NL](#) [PG0936.113NLT](#) [9220-20](#) [9310-16](#) [PM06-2N7](#) [PM06-39NJ](#) [A01TK](#) [1206CS-471XJ](#) [HC2-R47-R](#) [HC8-1R2-R](#)
[HCF1305-3R3-R](#) [1206CS-151XG](#) [RCH664NP-4R7M](#) [RCP1317NP-391L](#) [DH2280-4R7M](#) [DS1608C-106](#) [B10TJ](#) [B82498B3101J000](#) [ELJ-](#)
[RE27NJF2](#) [1812CS-153XJ](#) [1812CS-183XJ](#) [1812CS-223XJ](#) [1812LS-104XJ](#) [1812LS-105XJ](#) [1812LS-124XJ](#) [1812LS-154XJ](#) [1812LS-223XJ](#)
[1812LS-224XJ](#) [1812LS-563XJ](#) [1812LS-683XJ](#) [1812LS-824XJ](#) [NIN-FB101JTR110F](#) [NIN-FB471JTR62F](#) [NIN-FC1R5JTR220F](#) [NIN-](#)
[HCR15JTRF](#) [NIN-HCR33JTRF](#) [NIN-HDR22JTRF](#) [NIN-HDR82JTRF](#) [NIN-HK2N7STRF](#) [NIN-PA150KTR370F](#) [NIN-PB100KTR550F](#)